

MOS 12-28VDC 100KHZ

Weidmüller Interface GmbH & Co. KG

Klingenbergstraße 26

D-32758 Detmold

Germany

www.weidmueller.com



Compact and powerful solid-state relays in terminal block format

Saving space in the panel is becoming more and more important, and requires increasingly compact components. With the compact and powerful MICROOPTO solid-state relays, you benefit from our decades of experience in manufacturing products in terminal block format. The MICROOPTO family comprises high-quality solid-state relays for applicationspecific problem solving and delivers high performance in a width of just 6.1 mm. The wide range of accessories from plug-in cross-connections to end-to-end marking solutions makes it particularly versatile. Thanks to international approvals, they can be used worldwide. Reliable function is ensured by the integrated protective suppressor circuit for inputs and outputs. The wide MICROOPTO portfolio includes a range of solutions for special loads. For example, for inductive loads up to 10 A at 24 V DC or for DC loads up to 300 V. In addition, there are solutions for decoupling 5 V TTL inputs and outputs, for frequencies up to 550 kHz, as well as the single CO contact version for inverting signals.

General ordering data

Version	MICROOPTO, Solid-state relay, Rated control voltage: 12 V DC...28 V DC , Rated switching voltage: 19.6...28.8 V DC, Continuous current: 50 mA, Screw connection
Order No.	8937990000
Type	MOS 12-28VDC 100KHZ
GTIN (EAN)	4032248716227
Qty.	1 pc(s).

MOS 12-28VDC 100KHZ

Weidmüller Interface GmbH & Co. KG

Klingenbergstraße 26

D-32758 Detmold

Germany

www.weidmueller.com

Technical data

Dimensions and weights

Depth	97.8 mm	Depth (inches)	3.85 inch
Height	88.1 mm	Height (inches)	3.468 inch
Width	6.1 mm	Width (inches)	0.24 inch
Net weight	31.81 g		

Temperatures

Storage temperature	-40 °C...80 °C	Operating temperature	-25 °C...60 °C
Humidity	5-95% relative humidity, T _u = 55°C, without condensation		

Probability of failure

MTTF	2,559 Years
------	-------------

Environmental Product Compliance

REACH SVHC	Lead 7439-92-1
------------	----------------

Control side

Rated control voltage	12...28 V DC	Power rating	≤ 360 mW
Pull-in/drop-out voltage, typ.	5.6 V / 5 V DC	Status indicator	Green LED
Protective circuit	Varistor, Reverse polarity protection		

Load side

Rated switching voltage	19.6...28.8 V DC	Continuous current	0.05 A
Voltage drop at max. load	≤ 2 V	Leakage current	< 1 µA
Switch-on delay	< 200 ns	Switch-off delay	< 400 ns
max. switching frequency (DC control voltage)	530 kHz	Nominal auxiliary voltage	19.6...28.8 V / max. 8 mA
Load category	LC A	Pulse load, max. current	0.6 A (20 ms)
Protective circuit, load side	Varistor, Reverse polarity protection	Short-circuit-proof	No
Contact type	1 NO contact (Transistor)		

General data

Rail	TS 35		
Colour	black		
UL 94 flammability rating	V-0		
UL94 flammability rating component	Component	Housing	
	UL94 flammability rating	V-0	

Insulation coordination

Rated voltage	30 V	Pollution severity	2
Surge voltage category	II	Dielectric strength for control side - load side	350 V _{eff} / 1 min.
Dielectric strength to mounting rail	350 V _{eff} / 1 min.	Impulse withstand voltage	500 V (1,2/50 µ)
Protection degree	IP20		

Creation date March 26, 2022 3:40:04 AM CET

Catalogue status 11.03.2022 / We reserve the right to make technical changes.

MOS 12-28VDC 100KHZ

Weidmüller Interface GmbH & Co. KG

Klingenbergstraße 26

D-32758 Detmold

Germany

www.weidmueller.com

Technical data

Further details of approvals / standards

Standards	GL 2003-VI-Abs. 9, IEC 62314, UL508	Certificate No. (DNVGL)	TAE000033E
Certificate No. (GERMLLOYD)	54853-08	Certificate no. (cULus)	E141197

Connection data

Wire connection method	Screw connection	Stripping length, rated connection	7 mm
Tightening torque, min.	0.4 Nm	Tightening torque, max.	0.6 Nm
Clamping range, rated connection	2.5 mm ²	Clamping range, min.	0.5 mm ²
Clamping range, max.	4 mm ²	Wire cross-section, solid, min.	0.5 mm ²
Wire cross-section, solid, max.	4 mm ²	Wire connection cross section, finely stranded, min.	0.5 mm ²
Wire connection cross section, finely stranded, max.	2.5 mm ²	Wire connection cross-section, finely stranded with wire-end ferrules DIN 46228/4, min.	0.5 mm ²
Wire connection cross-section, finely stranded with wire-end ferrules DIN 46228/4, max.	1.5 mm ²	Conductor cross-section, flexible, AEH (DIN 46228-1), min.	0.5 mm ²
Conductor cross-section, flexible, AEH (DIN 46228-1), max.	1.5 mm ²	Blade size	0.6 x 3.5 mm

Classifications

ETIM 6.0	EC001504	ETIM 7.0	EC001504
ETIM 8.0	EC001504	ECLASS 9.0	27-37-16-04
ECLASS 9.1	27-37-16-04	ECLASS 10.0	27-37-16-04
ECLASS 11.0	27-37-16-04		

Important note

Product information The cable lengths must not exceed 30 m.

Approvals

Approvals



ROHS	Conform
UL File Number Search	E141197

Downloads

Approval/Certificate/Document of Conformity	EU Konformitätserklärung / EU Declaration of Conformity
Engineering Data	CAD data – STEP
Engineering Data	EPLAN, WSCAD
User Documentation	Beipackzettel / Package Insert – multilingual
Catalogues	Catalogues in PDF-format
Brochures	

Creation date March 26, 2022 3:40:04 AM CET

Catalogue status 11.03.2022 / We reserve the right to make technical changes.

MOS 12-28VDC 100KHZ

Weidmüller Interface GmbH & Co. KG
 Klingenbergstraße 26
 D-32758 Detmold
 Germany

www.weidmueller.com

Drawings

Wiring diagram

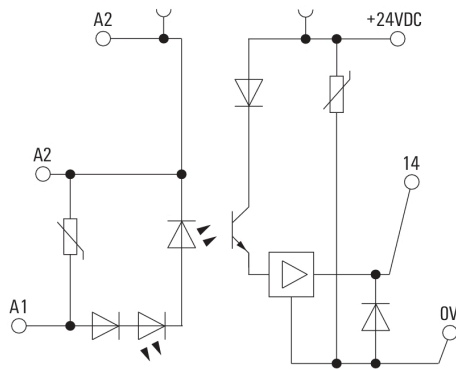

Max. switching frequency is dependent on the duty cycle deviation

MOS 12-28 V DC 100 kHz (switching current 50 mA, ohmic load)

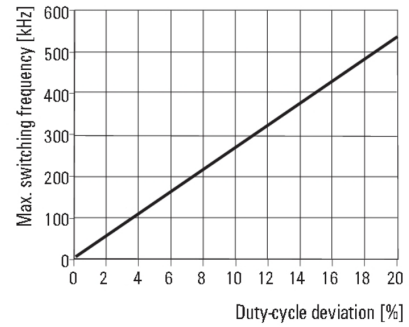

Max. switching frequency depending on the duty-cycle deviation

Dimensional drawing

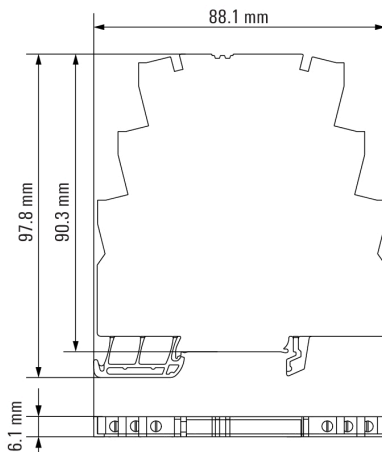

MOS 12-28VDC 100KHZ

Weidmüller Interface GmbH & Co. KG
 Klingenbergstraße 26
 D-32758 Detmold
 Germany

www.weidmueller.com

Accessories

Slotted screwdriver

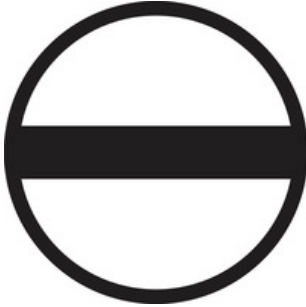

Slotted screwdriver with rounded blade SD DIN 5265, ISO 2380/2, output to DIN 5264, ISO 2380/1. ChromTop tip, SoftFinish grip

General ordering data

Type	SDS 0.6X3.5X100	Version
Order No.	2749340000	Screwdriver, Blade width (B): 3.5 mm, Blade length: 100 mm, Blade thickness (A): 0.6 mm
GTIN (EAN)	4050118895568	
Qty.	1 pc(s).	

Slotted screwdriver

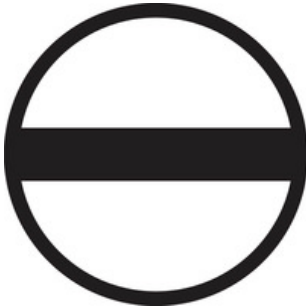

VDE insulated slot-head screwdriver, SDI DIN 7437, ISO 2380/2, drive output acc. to DIN 5264, ISO 2380/1. SoftFinish grip

General ordering data

Type	SDIS 0.6X3.5X100	Version
Order No.	2749810000	Screwdriver, Blade width (B): 3.5 mm, Blade length: 100 mm, Blade thickness (A): 0.6 mm
GTIN (EAN)	4050118897012	
Qty.	1 pc(s).	

MOS 12-28VDC 100KHZ

Weidmüller Interface GmbH & Co. KG
 Klingenbergstraße 26
 D-32758 Detmold
 Germany

www.weidmueller.com

Accessories

Slotted screwdriver



VDE insulated screwdriver sets, for working on live parts up to 1000 V AC and 1500 V DC, DIN EN 60900. IEC 900. Each piece is "GS" safety tested. Blade made from fully hardened, high-alloy chromium-vanadium-molybdenum steel, gun-metal finish.

General ordering data

Type	SDIS SLIM 0.6X3.5X100	Version
Order No.	2749610000	Mounting tool, Blade width (B): 3.5 mm, Blade length: 100 mm, Blade thickness (A): 0.6 mm
GTIN (EAN)	4050118896350	
Qty.	1 pc(s).	

4 mm²

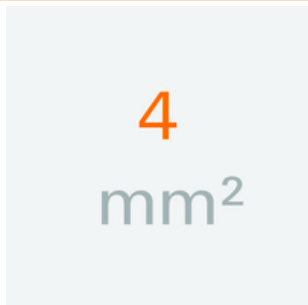

The plug-in cross-connections feature easy handling and quick installation. This saves a great deal of time during installation in comparison with screwed solutions.

General ordering data

Type	ZQV 4N/20 RT	Version
Order No.	1909150000	Accessories, Cross-connector, 32 A
GTIN (EAN)	4032248535934	
Qty.	20 pc(s).	
Type	ZQV 4N/10 SW	Version
Order No.	1794060000	Accessories, Cross-connector, 32 A
GTIN (EAN)	4032248234059	
Qty.	20 pc(s).	
Type	ZQV 4N/3 SW	Version
Order No.	1794000000	Accessories, Cross-connector, 32 A
GTIN (EAN)	4032248233793	
Qty.	60 pc(s).	
Type	ZQV 4N/2 SW	Version
Order No.	1793970000	Accessories, Cross-connector, 32 A
GTIN (EAN)	4032248233762	
Qty.	60 pc(s).	
Type	ZQV 4N/20 GE	Version
Order No.	1909020000	Accessories, Cross-connector, 32 A
GTIN (EAN)	4032248535644	
Qty.	20 pc(s).	

MOS 12-28VDC 100KHZ

Weidmüller Interface GmbH & Co. KG

Klingenbergstraße 26

D-32758 Detmold

Germany

www.weidmueller.com

Accessories

Type	ZQV 4N/20 BL	Version
Order No.	1909100000	Accessories, Cross-connector, 32 A
GTIN (EAN)	4032248535774	
Qty.	20 pc(s).	
Type	ZQV 4N/20 SW	Version
Order No.	1909120000	Accessories, Cross-connector, 32 A
GTIN (EAN)	4032248535804	
Qty.	20 pc(s).	
Type	ZQV 4N/4 SW	Version
Order No.	1794030000	Accessories, Cross-connector, 32 A
GTIN (EAN)	4032248233915	
Qty.	60 pc(s).	

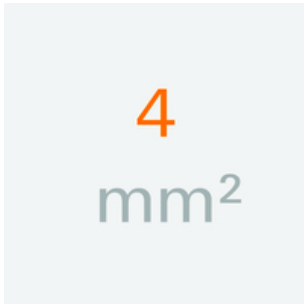
4 mm²

The plug-in cross-connections feature easy handling and quick installation. This saves a great deal of time during installation in comparison with screwed solutions.

General ordering data

Type	ZQV 4N/4 RD
Order No.	2460800000
GTIN (EAN)	4050118476224
Qty.	60 pc(s).
Type	ZQV 4N/3
Order No.	1527940000
GTIN (EAN)	4050118332865
Qty.	60 pc(s).
Type	ZQV 4N/3 BL
Order No.	1528080000
GTIN (EAN)	4050118333008
Qty.	60 pc(s).
Type	ZQV 4N/4
Order No.	1527970000
GTIN (EAN)	4050118332889
Qty.	60 pc(s).
Type	ZQV 4N/4 BL
Order No.	1528120000
GTIN (EAN)	4050118332872
Qty.	60 pc(s).
Type	ZQV 4N/10 RD
Order No.	2460740000
GTIN (EAN)	4050118476163
Qty.	20 pc(s).

Creation date March 26, 2022 3:40:04 AM CET

Catalogue status 11.03.2022 / We reserve the right to make technical changes.

7

MOS 12-28VDC 100KHZ

Weidmüller Interface GmbH & Co. KG
Klingenbergstraße 26
D-32758 Detmold
Germany

www.weidmueller.com

Accessories

Type	ZQV 4N/2 BL
Order No.	1528040000
GTIN (EAN)	4050118332773
Qty.	60 pc(s).

Type	ZQV 4N/2
Order No.	1527930000
GTIN (EAN)	4050118332766
Qty.	60 pc(s).

Type	ZQV 4N/2 RD
Order No.	2460450000
GTIN (EAN)	4050118476149
Qty.	60 pc(s).

Type	ZQV 4N/10 BL
Order No.	1528230000
GTIN (EAN)	4050118333138
Qty.	20 pc(s).

Type	ZQV 4N/10
Order No.	1528090000
GTIN (EAN)	4050118332896
Qty.	20 pc(s).

Type	ZQV 4N/3 RD
Order No.	2460810000
GTIN (EAN)	4050118476231
Qty.	60 pc(s).

MOS 12-28VDC 100KHZ

Weidmüller Interface GmbH & Co. KG

Klingenbergstraße 26

D-32758 Detmold

Germany

www.weidmueller.com

Accessories

MICROOPTO



Compact and powerful solid-state relays in terminal block format

Saving space in the panel is becoming more and more important, and requires increasingly compact components. With the compact and powerful MICROOPTO solid-state relays, you benefit from our decades of experience in manufacturing products in terminal block format. The MICROOPTO family comprises high-quality solid-state relays for applicationspecific problem solving and delivers high performance in a width of just 6.1 mm. The wide range of accessories from plug-in cross-connections to end-to-end marking solutions makes it particularly versatile. Thanks to international approvals, they can be used worldwide. Reliable function is ensured by the integrated protective suppressor circuit for inputs and outputs. The wide MICROOPTO portfolio includes a range of solutions for special loads. For example, for inductive loads up to 10 A at 24 V DC or for DC loads up to 300 V. In addition, there are solutions for decoupling 5 V TTL inputs and outputs, for frequencies up to 550 kHz, as well as the single CO contact version for inverting signals.

General ordering data

Type	MOS FEED THROUGH	Version
Order No.	8973450000	MICROOPTO, Feed-through terminal, Screw connection
GTIN (EAN)	4032248799534	
Qty.	1 pc(s).	
Type	MOS SUPPLY	Version
Order No.	8973460000	MICROOPTO, Supply module, Screw connection
GTIN (EAN)	4032248799541	
Qty.	1 pc(s).	

MOS 12-28VDC 100KHZ

Weidmüller Interface GmbH & Co. KG
 Klingenbergstraße 26
 D-32758 Detmold
 Germany

www.weidmueller.com

Accessories

Blank



WS markers are the perfect match for the W-series connectors. Thanks to their system compatibility, the WS tags can also be used with the I-series and the Z-series. The large marking surfaces do not only permit long character strings but also multi-line text. WS markers are ideal for labels with long, customised character strings. Thanks to the proven MultiCard format, printing with PrintJet CONNECT oder/or Plotter is possible.

- Can be fitted in strips or individually
- Markers in proven MultiCard format

For custom printing: Please send us a file of our labeling software M-Print PRO or M-Print PRO Online (without installation) for your labeling specifications.

General ordering data

Type	WS 12/6 MC NE WS	Version
Order No.	1609900000	WS, Terminal marker, 12 x 6 mm, Pitch in mm (P): 6.00 Weidmueller,
GTIN (EAN)	4008190203467	Allen-Bradley, white
Qty.	600 pc(s).	

X-ON Electronics

Largest Supplier of Electrical and Electronic Components

Click to view similar products for [Solid State Relays - Industrial Mount](#) category:

Click to view products by [Weidmuller](#) manufacturer:

Other Similar products are found below :

[D2440-C](#) [H10CA4890](#) [D4875C](#) [1395831-1](#) [1616010-6](#) [BR312BY](#) [A-1326](#) [H10CA4850](#) [H12CA4890VL](#) [RA2410-D06](#) [RA2410HA06T](#)
[D1202F](#) [D53TP50-10](#) [W230E-1-12](#) [W230T-3-12](#) [1-1617030-3](#) [1-1617033-7](#) [MS2-D2420](#) [MS2-D2430](#) [A-1440](#) [RJ1P60V50E](#) [HS501DR-](#)
[D2425](#) [RN1F48I50](#) [70.362.1028.0](#) [7-1393030-8](#) [Z5.509.0828.0](#) [G3DZ-4B DC24](#) [G3DZ-F4B DC12](#) [2912138](#) [SSRDAC10](#) [SSR-10048RD1](#)
[RV8S-L-A240-D24](#) [RV8S-L-A240-D6](#) [RV8S-S-A240-D6](#) [RV8S-S-A240Z-D24](#) [RV8S-S-D24-A240](#) [RV8S-S-D48-A120](#) [RN1F12V50](#)
[RJ1P60I30E](#) [RJ1P60V30E](#) [SO967860](#) [SMT8628521](#) [SO869970](#) [SOD867180](#) [SAL961360](#) [SO867970](#) [SOB863860](#) [SOB867640](#) [G3PH-](#)
[5150B DC5-24](#) [G3PH-2075B DC5-24](#)