

Interface Units

Interface Units	Introduction	A.2
	Interface Units IEC 603-1 – DIN 41651 (Ribbon Connector)	A.6
	Interface Units IEC 807-2 – DIN 41652 (Sub-D Connector)	A.9
	Supply Voltage Distributor Modules	A.13
	Interface Units with RJ45 Plug Connectors	A.15
	ELCO Interface Unit	A.16
	T-CON Interface Unit	A.17

Weidmüller interface units

A

Given the need to reduce costs in electrical cabinet construction, interface units offer an alternative to wiring concepts with point-to-point wiring. The prime function of interface units is to act as a trouble-free adapter element between standardized plug connectors and point-to-point wiring or other connection systems.

Interface units consist of the following individual components:

- Extruded profile for inserting the PCB
- End plates for fitting on the mounting rail
- Clip-on feet for locking on standardized mounting rails TS 32 and TS 35
- PCB with connecting and indicating elements, DIN plug connectors and ample marking facilities for equipment identification

The plug connectors used for the interface units can be divided into the following groups:

- Plug connector to IEC 603-1/DIN 41651
- Sub-miniature plug connectors (SUB-D) to IEC 807-2/DIN 41652
- Plug connectors for PCBs to IEC 603/DIN 41612 and DIN 41615
- ELCO plug connectors for hazardous area applications

Advantages of the interface units:

- Two- and three-tier PCB terminals save space
- Conventional point-to-point wiring only needed on one side, thus saving costs
- Greater safety, preventing wiring errors
- Optional: status LED on the interface units
- Rapid troubleshooting with additional test and measuring devices
- Simplified setup and documentation

Interface units let users implement pioneering concepts in switchboard design with potential for rationalization. Customized wiring concepts can also be solved rationally through the use of special interface units.

Pre-assembled leads with the corresponding plug connector systems are used as the connection between the series-connected controller and the interface unit. This provides the greatest savings for the user. The use of interface units reduces the individual circuitry, which reduces labor and installation time and also hidden costs, in particular a reduction material costs following a reduction in the number of individual cables and leads, cable ducts, terminals and terminal blocks required. The transition to point-to-point wiring takes place directly at the interface element.

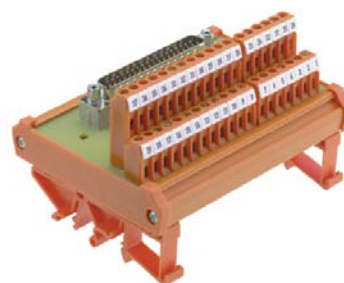

Users have a choice between screw, tension clamp or spade connections for connecting actuators and/or sensors. As an option, interface units can also integrate additional functions such as status indicator, signal disconnecter, fuses or shielding. Identification systems make it easier to trace the signals to the corresponding element.

RSF interface units for pre-assembled leads with plug connectors to IEC 603-1/DIN 41651

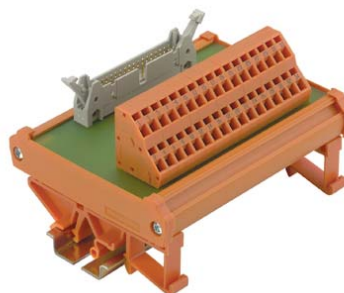

Passive interface for 10 ... 64 signals for adapting pre-assembled leads with plug connectors to IEC 603-1 / DIN 41651 to screw or tension clamp connection systems.

When used in combination with a status indicator (LED), this guarantees rapid information about the switching state of incoming and outgoing signals.

RSSD interface units for pre-assembled leads with SUB-D plug connectors to IEC 807-2/DIN 41652

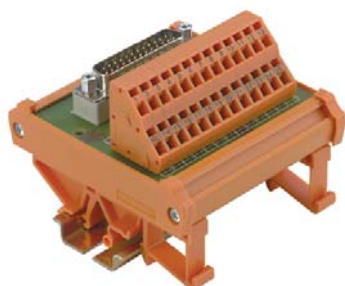

Passive interface unit for 9 ... 50 signals for adapting pre-assembled leads with SUB-D plug to IEC 807-2/DIN 41652 to screw or tension clamp connection systems.

The components are supplied with either female or male connectors. A spacer block between plug connector and PCB cushions the mechanical forces occurring between the connected cables. RSSD interface units can be supplied with an ground terminal for shielded leads as an optional feature. An additional test point simplifies testing and measuring during initial setup and when servicing the system.

RS VERT interface units as voltage distributor

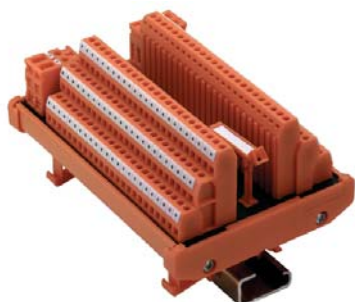

Passive interface units for the distribution of dc supply voltage. These interface units are available in three designs for distribution to 8, 16 and 72 connections, for positive and negative voltages in each case:

- 8x and 16x distributor just 45 mm wide overall, 72x distributor 100 mm wide
- Fed by two connection elements for positive and negative voltages in each case
- Fits on TS32/35 mounting rails

RS VERT voltage distributors can also be used in small enclosures and provide clearly organized distribution.

RS ELCO interface units for pre-assembled leads with hermaphrodite plug connector system

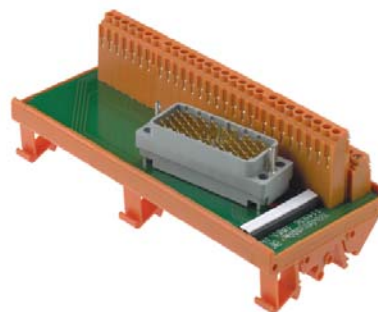

Weidmüller's passive interface units are used for adapting hermaphrodite ELCO multi-pole connectors, for input and output, to screw terminal systems. The hermaphrodite contact is a fork-type contact that is identical in design on both sides of the connection, but with one fork turned through 90° to engage with the other.

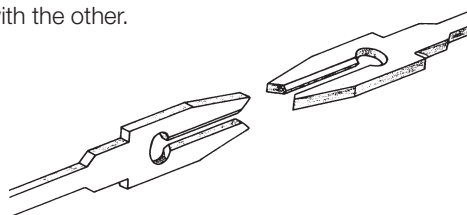

RS RJ45 interface units for connecting data lines



The RS RJ45 interface module offers the user a convenient, easy-to-use interface for connecting modems, notebooks and other office equipment in the electrical cabinet.

The module converts the standard RJ45 connection to a screw terminal system or acts as a coupling to connect data leads by means of two RJ45 sockets. For data transmission rates of up to 100 Mbps, it is advisable to connect one end of the shield of the data cable to a protective ground. The interface modules can be fitted on TS 32/35 mounting rails.

Weidmuller Custom Solutions

It's a Matter of Getting what you need

Custom Design and Engineering – Designed for Your Application

Great ideas for new products and new applications often push companies into uncharted territory, where existing interface products fall short of their design requirements.



Our design team works closely with you each step of the way.



Our goal is to provide you with the most responsive service possible.

Weidmuller has an unparalleled record of innovation in interface products extending back over 50 years – and we're happy to make this expertise available to you through our custom engineering services, which include both the design and the manufacture of tailor-made interface products. Whether it's PCB terminal blocks and connectors, DIN-rail terminal blocks, controller front panel adapters or controller interface products, we will work with you to create a custom solution that meets your needs – exactly.

And because our success at Weidmuller rests on long-term relationships, we welcome opportunities to partner with you to create the products you need.



Weidmuller is your best source for PCB terminal blocks and connectors, DIN-rail terminal blocks, controller front panel adapters and interface products that meet your application needs precisely. We work with you to manage the process carefully to ensure timely delivery and complete satisfaction.

With Weidmuller's expertise in custom solutions, there is no need to compromise.

Final design drawings are developed for review and approval.

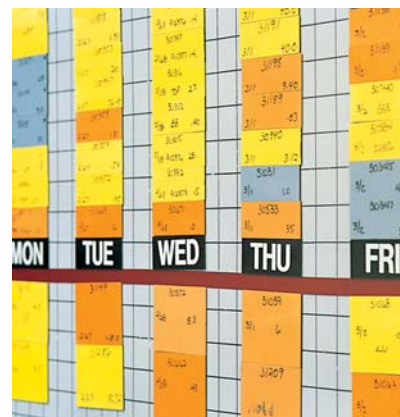
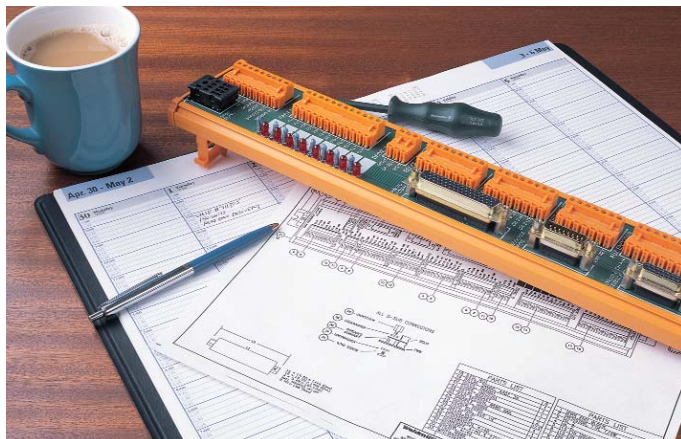

We work with you to pinpoint schedule and delivery requirements.

1) Getting it Right from the Start

Once an application is identified, we mobilize our design team immediately. We work with you to pinpoint your design specifications, delivery and scheduling requirements.

As part of this effort, we establish an open line of communication between you and a designated point person for your project. Expert technical support is also available all the way through the project to address issues that arise during the design and manufacturing process.

2) Building Relationships Before Building the Product

At Weidmüller, we place a premium on building long-term customer relationships. We will explain our custom design and engineering process in detail, and, as needed, partner with you to meet your needs for custom products.

3) Offering Alternatives

One of the advantages of working with Weidmüller is the depth of our product design and manufacturing experience. You can count on us to carefully review the special requirements for your application and, if necessary, present several approaches and to compare the advantages of each one.

4) Developing Final Drawings and Models

At Weidmüller, we want to make absolutely sure that a custom product design meets your requirements. Using the latest CAD technology, we create final design drawings and stereolithographic models, as appropriate.

5) Establishing Time Frames

Upon your approval, we begin the tooling process, schedule production, and set delivery dates based on the needs of your application. Our Fastrack Custom Solutions can accelerate the custom design and engineering process even further. In many cases, we will produce conceptual drawings for you within two days of project agreement.

OUR FASTRACK CUSTOM SOLUTIONS ARE THE RIGHT TRACK FOR YOUR PRODUCT DEVELOPMENT NEEDS WHEN:

- **Standard products won't meet your unique application need**
- **You need a design partner to offer innovative alternatives and solutions**
- **You need a truly innovative product to put you ahead of the competition**
- **Market pressures dictate a fast turnaround on a custom product design**



Interface Units IEC 603-1 - DIN 41651 (Ribbon Connector)

Interface units IEC 603-1
DIN 41651 (Ribbon connector)

- Pin connector with locking feature to IEC 603-1
- Tension clamp or screw connection system
- 45 or 87 mm wide
- For mounting on TS32, TS35 x 7.5 and TS35 x 15

RSF Z/ IEC 603-1



RSF S 45 mm/ IEC 603-1

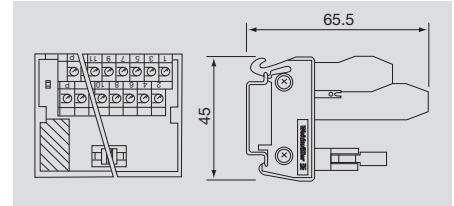
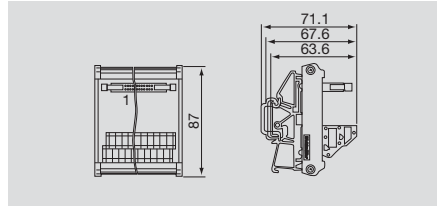
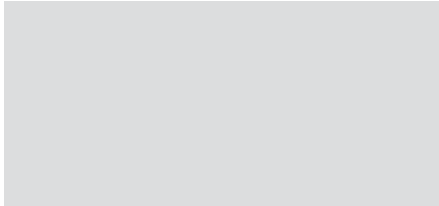
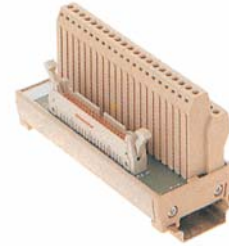

Technical data

Connection data

Connection on process side
Stripping length
Connection on control side

PCB terminal LM2NZF / Tension clamp
7.0 mm
Plug-in connector to IEC 603-1/ DIN 41651

PCB terminal LPK 2 H / Screw connection
7.0 mm
Plug-in connector to IEC 603-1/ DIN 41651

Rated data

Conversion PCB/plug connector
Rated voltage
Rated current per connection
Test voltage (~eff)
Test torque
Storage temperature
Ambient temperature (operational)
Terminal rail

1:1
60 V AC/ 75 V DC
1 A
1.0 kV
-40 °C...+70 °C
0 °C...+55 °C

1:1
60 V AC/ 75 V DC
1 A
1.0 kV
0.40 Nm
-40 °C...+70 °C
0 °C...+55 °C
TS 35

Insulation coordination (EN 50178)

Surge category
Pollution severity

III
2

III
2

Approvals

Standards

EN 50178

EN 50178

Clamping range (rating- / min. / max.)

mm²

1.5 / 0.5 / 2.5

Length x width x height

mm

87.0 x – x 64.0

1.5 / 0.5 / 2.5

45.0 x – x 65.5

Note

Ordering data

10-pole
14-pole
16-pole
20-pole
26-pole
34-pole
40-pole
50-pole
60-pole
64-pole

Type	Width	Order No.
RS F10 Z	50.0 mm	8537190000
RS F14 Z	50.0 mm	8537200000
RS F20 Z	65.0 mm	8537110000
RS F26 Z	80.0 mm	8537180000
RS F34 Z	110.0 mm	8537130000
RS F40 Z	115.0 mm	8537140000
RS F50 Z	145.0 mm	8537150000

Type	Width	Order No.
RS F10 LPK 2H/12	49.0 mm	8155610000
RS F14 LPK 2H/16	56.0 mm	8258980000
RS F16 LPK 2H/18	64.0 mm	8265540000
RS F20 LPK 2H/22	71.0 mm	8155600000
RS F26 LPK 2H/28	86.0 mm	8213470000
RS F34 LPK 2H/36	106.0 mm	8155590000
RS F40 LPK 2H/42	121.0 mm	8155580000
RS F50 LPK 2H/52	150.3 mm	8155570000
RS F60 LPK 2H/62	180.0 mm	8259000000
RS F64 LPK 2H/66	186.0 mm	8155550000

Note

Accessories

Note

For ribbon cable connections according to UL 508A recognition or with accessory holes

- With mounting foot for TS 32, TS 35 x 7.5 and TS 35 x 15 rails
- Male connector block with interlock for female connector block with strain relief according to DIN 41 651/Parts 1 and 2
- Available with screw connection

RI-IDC

Cable interface units for ribbon cables
Screw connection
Male Standard

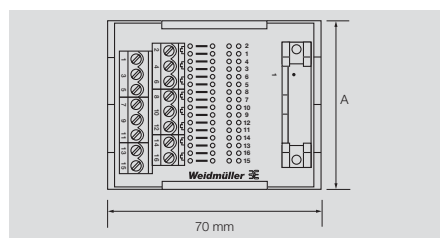

RI-IDC

Cable interface units for ribbon cables
Screw connection
Male with accessory holes

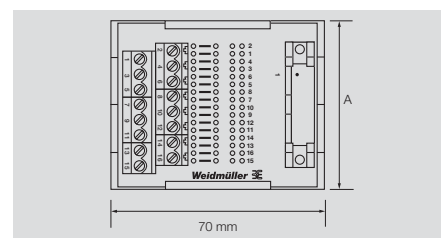

Technical data

Connection data

- Process side
- Type
- Control side
- Type

Rated data

Rated voltage
Rated current per contact
Operating temperature
Storage temperature

Terminal wire size

Insulation stripping length mm (in.)

Dimensions

Overall width mm (in.)

Screw connection
LP2N terminal
Plug connection
Ribbon connector

125 V
1 A
-25°C...+50°C
-40°C...+70°C

AWG 26...12
7 (.28)

See table, dim. A

Screw connection
LP2N terminal
Plug connection
Ribbon connector

125 V
1 A
-25°C...+50°C
-40°C...+70°C

AWG 26...12
7 (.28)

See table, dim. A

Ordering data

dimensions (mm/in.)

Poles	Dim. A	Dim. B	Dim. C	Dim. D
10	39.88 (1.57)	50 (1.97)	49 (1.93)	40 (1.57)
14	49.78 (1.96)	50 (1.97)	56 (2.20)	45 (1.77)
16	55.12 (2.17)	55 (2.17)	64 (2.52)	50 (1.97)
20	64.77 (2.55)	65 (2.56)	71 (2.80)	50 (1.97)
26	84.84 (3.34)	80 (3.15)	86 (3.39)	55 (2.17)
30	94.74 (3.73)			
34	104.65 (4.12)	110 (4.33)	106 (4.17)	70 (2.76)
40	120.14 (4.73)	115 (4.53)	121 (4.76)	80 (3.15)
50	142.49 (5.60)	145 (5.71)	151 (5.94)	95 (3.74)
60	175.01 (6.89)	180 (7.09)	180 (7.09)	115 (4.53)
64	181.61 (7.15)	180 (7.09)	186 (7.32)	120 (4.72)

On TS 35 x 7.5

Type	Order No.
UL 508A — Male standard	
RI-IDC 10	915911
RI-IDC 14	915912
RI-IDC 16	915913
RI-IDC 20	915914
RI-IDC 26	915915
RI-IDC 30	915916
RI-IDC 34	915917
RI-IDC 40	915918
RI-IDC 50	915919
RI-IDC 60	915920
RI-IDC 64	915921

Type	Order No.
Male w/ accessory holes	
RI-IDC 10	914890
RI-IDC 14	914891
RI-IDC 16	914892
RI-IDC 20	914893
RI-IDC 26	914894
RI-IDC 30	914895
RI-IDC 34	914896
RI-IDC 40	914897
RI-IDC 50	914898
RI-IDC 60	914899
RI-IDC 64	914900

Accessories

Mounting rail	
End bracket	for TS 32 for TS 35
Terminal wire marking	

Type	Order No.
TS 32	0122800000
TS 35 x 7.5	0383400000
TS 35 x 15	0498000000
EWK 2	0199360000
EW 35	0383560000
DEK 5	

Type	Order No.
TS 32	0122800000
TS 35 x 7.5	0383400000
TS 35 x 15	0498000000
EWK 2	0199360000
EW 35	0383560000
DEK 5	

Interface Units IEC 603-1 - DIN 41651 (Ribbon Connector)

Interface units IEC 603-1
DIN 41651 (Ribbon connector)

- Pin connector with locking feature to IEC 603-1
- Screw connection system
- 87 mm wide
- For mounting on TS32, TS35 x 7.5 and TS35 x 15

RSF S/ IEC 603 -1



RSF S/ IEC 603-1

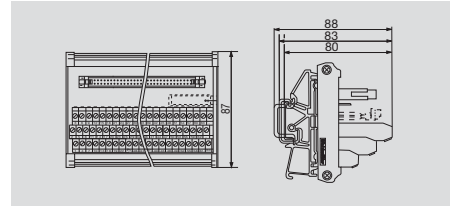
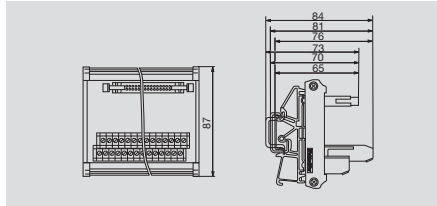
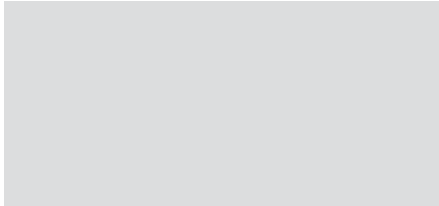
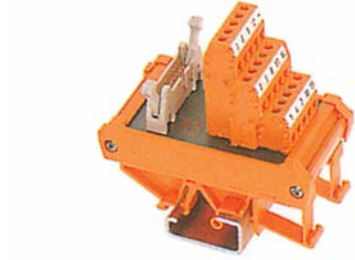

Technical data

Connection data

Connection on process side
Stripping length
Connection on control side

PCB terminal LP2N
7.0 mm
Plug-in connector to IEC 603-1/ DIN 41651

PCB terminal LP3R
7.0 mm
Plug-in connector to IEC 603-1/ DIN 41651

Rated data

Conversion PCB/plug connector
Rated voltage
Rated current per connection
Test voltage (~eff)
Test torque
Storage temperature
Ambient temperature (operational)
Terminal rail

1:1
60 V AC/ 75 V DC
1 A
1.0 kV
0.50 Nm
-40 °C...+60 °C
0 °C...+55 °C
TS 32, TS 35

1:1
60 V AC/ 75 V DC
1 A
1.0 kV
0.50 Nm
-40 °C...+70 °C
0 °C...+55 °C
TS 32, TS 35

Insulation coordination (EN 50178)

Surge category
Pollution severity

III
2

III
2

Approvals

Standards

EN 50178

EN 50178

Clamping range (rating- / min. / max.)

mm²

2.5 / 0.5 / 4

2.5 / 0.5 / 4

Length x width x height

mm

87.0 x – x 70.0

87.0 x – x 76.0

Note

Ordering data

10-pole
14-pole
16-pole
20-pole
26-pole
34-pole
40-pole
50-pole
60-pole
64-pole

Type	Width	Order No.
RS F10 LP2N 5/10	50.0 mm	0224961001
RS F14 LP2N 5/14	50.0 mm	0225061001
RS F16 LP2N 5/16	55.0 mm	0225161001
RS F20 LP2N 5/20	65.0 mm	0224261001
RS F26 LP2N 5/26	80.0 mm	0224861001
RS F34 LP2N 5/34	110.0 mm	0224361001
RS F40 LP2N 5/40	115.0 mm	0224461001
RS F50 LP2N 5/50	145.0 mm	0224561001
RS F60 LP2N 5/60	180.0 mm	0224661001
RS F64 LP2N 5/64	180.0 mm	0224761001

Type	Width	Order No.
RS F10 LP3R 3/12	40.0 mm	8012850000
RS F14 LP3R 3/14	45.0 mm	8012860000
RS F16 LP3R 3/18	50.0 mm	8012870000
RS F20 LP3R 3/21	50.0 mm	8012910000
RS F26 LP3R 3/27	55.0 mm	8012920000
RS F34 LP3R 3/36	70.0 mm	8012930000
RS F40 LP3R 3/42	80.0 mm	8012940000
RS F50 LP3R 3/51	95.0 mm	8012950000
RS F60 LP3R 3/63	115.0 mm	8012960000
RS F64 LP3R 3/66	120.0 mm	8012970000

Note

Accessories

Note

For D-subminiature plug-in connectors according to UL 508A recognition

- With mounting foot for TS 32, TS 35 x 7.5 and TS 35 x 15 rails
- Male and female connectors with screw/locking system UNC 4/40
- Available with screw connection

RD

Male connector
Standard

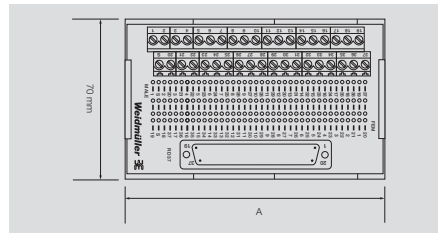

RD

Female connector
Standard

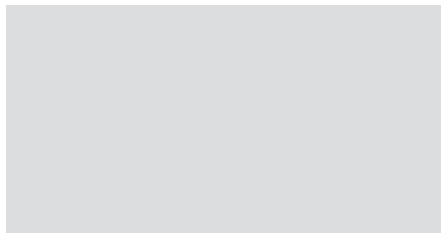
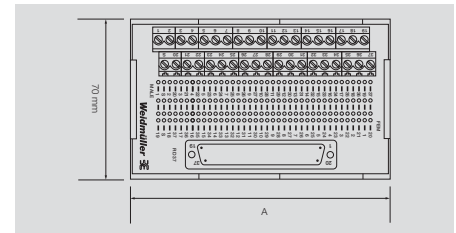

Technical data

Connection data

- Process side
- Type
- Control side
- Type

Rated data

- Rated voltage
- Rated current per contact
- Operating temperature
- Storage temperature

Terminal wire size

Insulation stripping length mm (in.)

Dimensions

Overall width mm (in.)

Screw connection
LP2N terminal
Plug connection
Sub-D

150 V
1.5 A
-25°C...+50°C
-40°C...+70°C

AWG 26...12
7 (.28)

See table, dim. A

Screw connection
LP2N terminal
Plug connection
Sub-D

150 V
1.5 A
-25°C...+50°C
-40°C...+70°C

AWG 26...12
7 (.28)

See table, dim. A

Ordering data

dimensions (mm/in.)

Poles	Cable Connector Retainer*	Dim. A
9	Screw	39.88 (1.57)
9	Jackscrew	39.88 (1.57)
15	Screw	55.12 (2.17)
15	Jackscrew	55.12 (2.17)
25	Screw	85.09 (3.35)
25	Jackscrew	85.09 (3.35)
37	Screw	116.84 (4.60)
37	Jackscrew	116.84 (4.60)
50	Screw	149.35 (5.88)
50	Jackscrew	149.35 (5.88)

On TS 35 x 7.5

Type

Type	Order No.
UL 508A – Male standard	
RD-9	915933
RD-9JS	915935
RD-15	915958
RD-15JS	915941
RD-25	915947
RD-25JS	915949
RD-37	915954
RD-37JS	915956
RD-50	919658
RD-50JS	919656

Type

Type	Order No.
UL 508A – Female standard	
RD-9	915934
RD-9JS	915936
RD-15	915940
RD-15JS	915942
RD-25	915948
RD-25JS	915953
RD-37	915955
RD-37JS	915957
RD-50	919657
RD-50JS	919655

Accessories

Mounting rail	
End bracket	for TS 32 for TS 35
Terminal wire marking	

Note :

* Cable connector retainer has either a jackscrew receptacle for a thumb screw or has a mounted screw in the module cable connector.

Type

Type	Order No.
TS 35 x 7.5	0383400000
TS 35 x 15	0498000000
EWK 2	0199360000
EW 35	0383560000
DEK 5	

Type

Type	Order No.
TS 35 x 7.5	0383400000
TS 35 x 15	0498000000
EWK 2	0199360000
EW 35	0383560000
DEK 5	

Interface Units IEC 807-2 - DIN 41652 (Sub-D Connector)

For D-subminiature plug-in connectors with accessory holes

- With mounting foot for TS 32, TS 35 x 7.5 and TS 35 x 15 rails
- Male and female connectors with screw/locking system UNC 4/40
- Available with screw connection

RD

Male connector with accessory holes†

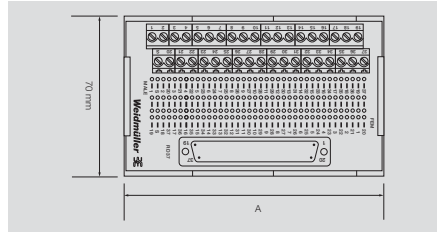
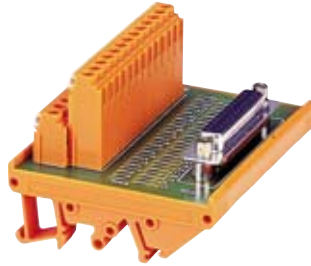

RD

Female connector with accessory holes†

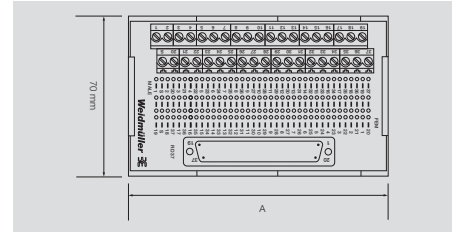

Technical data

Connection data

- Process side
- Type
- Control side
- Type

Rated data

Rated voltage
Rated current per contact
Operating temperature
Storage temperature

Terminal wire size

Insulation stripping length mm (in.)

Dimensions

Overall width mm (in.)

Screw connection
LP2N terminal
Plug connection
Sub-D

150 V
1.5 A
-25°C...+50°C
-40°C...+70°C

AWG 26...12

7 (.28)

See table, dim. A

Screw connection
LP2N terminal
Plug connection
Sub-D

150 V
1.5 A
-25°C...+50°C
-40°C...+70°C

AWG 26...12

7 (.28)

See table, dim. A

Ordering data

dimensions (mm/in.)

Poles	Cable Connector Retainer*	Dim. A
9	Screw	39.88 (1.57)
9	Jackscrew	39.88 (1.57)
15	Screw	55.12 (2.17)
15	Jackscrew	55.12 (2.17)
25	Screw	85.09 (3.35)
25	Jackscrew	85.09 (3.35)
37	Screw	116.84 (4.60)
37	Jackscrew	116.84 (4.60)
50	Screw	149.35 (5.88)
50	Jackscrew	149.35 (5.88)

On TS 35 x 7.5

Type	Order No.
Male w/ accessory holes	
RD-9	912385
RD-9JS	910638
RD-15	912395
RD-15JS	910644
RD-25	912405
RD-25JS	910648
RD-37	913155
RD-37JS	910642
RD-50	911883
RD-50JS	911884

Type	Order No.
Female w/ accessory holes	
RD-9	912380
RD-9JS	910641
RD-15	912390
RD-15JS	912393
RD-25	912400
RD-25JS	910645
RD-37	910075
RD-37JS	910640
RD-50	911885
RD-50JS	911886

Accessories

Mounting rail	
End bracket	for TS 32 for TS 35
Terminal wire marking	

Note :

* Cable connector retainer has either a jackscrew receptacle for a thumb screw or has a mounted screw in the module cable connector.

Type	Order No.
TS 35 x 7.5	0383400000
TS 35 x 15	0498000000
EWK 2	0199360000
EW 35	0383560000
DEK 5	

† Designates plug (S male) or socket (B female) connector on the interface module.

Type	Order No.
TS 35 x 7.5	0383400000
TS 35 x 15	0498000000
EWK 2	0199360000
EW 35	0383560000
DEK 5	

**Interface units IEC 807-2
DIN 41652 (Sub-D connector)**

- Pin and socket connector with screw locking system UNC 4/40
- Tension clamp or screw connection system
- 45 or 87 mm wide
- For mounting on TS32, TS35 x 7.5 and TS35 x 15

RSSD Z/ SUB-D

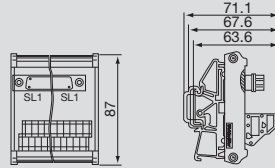

RSSD S/ SUB-D

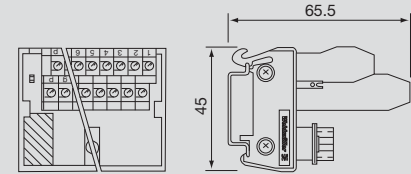

Technical data

Connection data

Connection on process side
Stripping length
Connection on control side

PCB terminal LM2NZF / Tension clamp
7.0 mm
D-SUB acc. IEC 807-2

PCB terminal LPK 2 H / Screw connection
7.0 mm
D-SUB acc. IEC 807-2

Rated data

Conversion PCB/plug connector
Rated voltage
Rated current per connection
Test voltage (~eff)
Test torque
Storage temperature
Ambient temperature (operational)
Terminal rail

1:1
125 V AC/ 150 V DC
1.5 A
0.6 kV
-40 °C...+70 °C
0 °C...+55 °C
TS 35 - TS 32

1:1
125 V AC/ 150 V DC
1.5 A
0.6 kV
0.40 Nm
-40 °C...+70 °C
0 °C...+55 °C
TS 35

Insulation coordination (EN 50178)

Surge category
Pollution severity

III
2

III
2

Approvals

Standards

EN 50178

EN 50178

Clamping range (rating- / min. / max.) mm²

1.5 / 0.5 / 2.5

1.5 / 0.5 / 2.5

Length x width x height mm

87.0 x – x 63.6

45.0 x – x 65.5

Note

Ordering data

Male connectors	9-pole	
Male connectors	15-pole	
Male connectors	25-pole	
Male connectors	37-pole	
Male connectors	50-pole	
Female connectors	9-pole	
Female connectors	15-pole	
Female connectors	25-pole	
Female connectors	37-pole	
Female connectors	50-pole	

Type	Width	Order No.
RS SD9 SZ	45.0 mm	8537260000
RS SD15 SZ	60.0 mm	8537390000
RS SD25 SZ	80.0 mm	8537370000
RS SD37 SZ	110.0 mm	8537240000
RS SD50 SZ	145.0 mm	8537350000
RS SD9 BZ	45.0 mm	8537320000
RS SD15 BZ	60.0 mm	8537400000
RS SD25 BZ	80.0 mm	8537380000
RS SD37 BZ	110.0 mm	8537250000

Type	Width	Order No.
RS SD9S UNC LPK2	50.0 mm	8259010000
RS SD15S UNC LPK2	61.0 mm	8233350000
RS SD25S UNC LPK2	86.0 mm	8155650000
RS SD37S UNC LPK2	116.0 mm	8155660000
RS SD50S UNC LPK2	154.0 mm	8155670000
RS SD9B UNC LPK2	50.0 mm	8216480000
RS SD15B UNC LPK2	61.0 mm	8209730000
RS SD25B UNC LPK2	86.0 mm	8155620000
RS SD37B UNC LPK2	116.0 mm	8155630000
RS SD50B UNC LPK2	154.0 mm	8155640000

Note

Accessories

Note

Interface Units IEC 807-2 - DIN 41652 (Sub-D Connector)

Interface units IEC 807-2
DIN 41652 (Sub-D connector)

- Pin and socket connector with screw locking system UNC 4/40
- PCB connection element with screw connection
- Clip-on foot for mounting on TS32, TS35 x 7.5 and TS35 x 15

RSSD S/ SUB-D

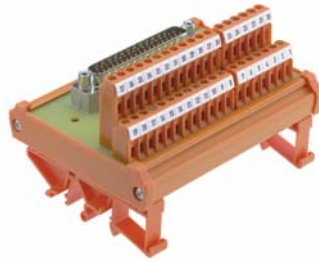

RSSD S/ SUB-D

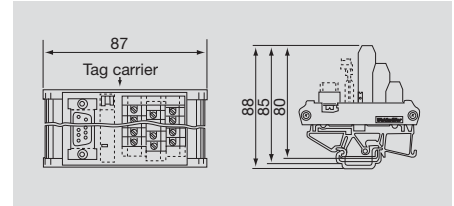
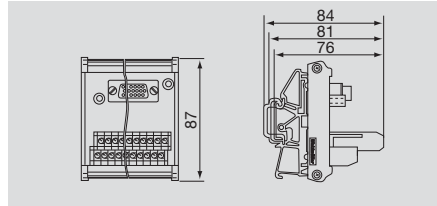
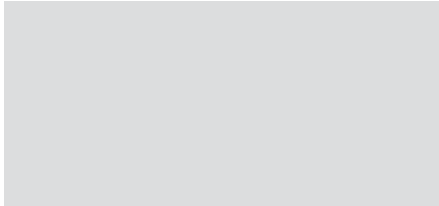

Technical data

Connection data

Connection on process side
Stripping length
Connection on control side

PCB terminal LP2N
7.0 mm
D-SUB acc. IEC 807-2

PCB terminal LP3R
7.0 mm
D-SUB acc. IEC 807-2

Rated data

Conversion PCB/plug connector
Rated voltage
Rated current per connection
Test voltage (~eff)
Test torque
Storage temperature
Ambient temperature (operational)
Terminal rail

1:1
125 V AC/ 150 V DC
1.5 A
0.6 kV
0.50 Nm
-40 °C...+70 °C
0 °C...+55 °C
TS 32, TS 35

1:1
125 V AC/ 150 V DC
1.5 A
0.6 kV
0.50 Nm
-40 °C...+70 °C
0 °C...+55 °C
TS 32, TS 35

Insulation coordination (EN 50178)

Surge category
Pollution severity

III
2

III
2

Approvals

Standards

EN 50178

EN 50178

Clamping range (rating- / min. / max.)

mm²

2.5 / 0.5 / 4

Length x width x height

mm

87.0 x – x 76.0

2.5 / 0.5 / 4

87.0 x – x 80.0

Note

Ordering data

	Type	Width	Order No.	Type	Width	Order No.	
Male connectors	9-pole	RS SD9S UNC 4.40 LP2N	45.0 mm	8003901001	RS SD9S LP3R	40.0 mm	8019930000
Male connectors	15-pole	RS SD15S UNC 4.40	60.0 mm	8005201001	RS SD15S LP3R	45.0 mm	8019940000
Male connectors	25-pole	RS SD25S UNC 4.40 LP2N	80.0 mm	8005181001	RS SD25S LP3R	60.0 mm	8019950000
Male connectors	37-pole	RS SD37S UNC 4.40 LP2N	110.0 mm	8003881001	RS SD37S LP3R	80.0 mm	8019960000
Male connectors	50-pole	RS SD50S UNC 4.40 LP2N	154.0 mm	8005161001	RS SD50S LP3R	100.0 mm	8019970000
Female connectors	9-pole	RS SD9B UNC 4.40 LP2N	45.0 mm	8003911001	RS SD9B LP3R	40.0 mm	8019880000
Female connectors	15-pole	RS SD15B UNC 4.40 LP2N	60.0 mm	8005211001	RS SD15B LP3R	45.0 mm	8019890000
Female connectors	25-pole	RS SD25B UNC 4.40 LP2N	80.0 mm	8005191001	RS SD25B LP3R	60.0 mm	8019900000
Female connectors	37-pole	RS SD37B UNC 4.40 LP2N	110.0 mm	8003891001	RS SD37B LP3R	80.0 mm	8019910000
Female connectors	50-pole	RS SD50B UNC 4.40 LP2N	154.0 mm	8005171001	RS SD50B LP3R	100.0 mm	8019920000

Note

Accessories

Note

Supply voltage distributor modules

- Distribution module for 2 supply connections to 8 or 16 potential distribution terminals
- 45 mm wide
- Potential distributor designed as two level connection element
- Total current max. 10 A
- For mounting on rail TS35 x 7.5 and TS35 x 15

RS VERT 8 LPK2

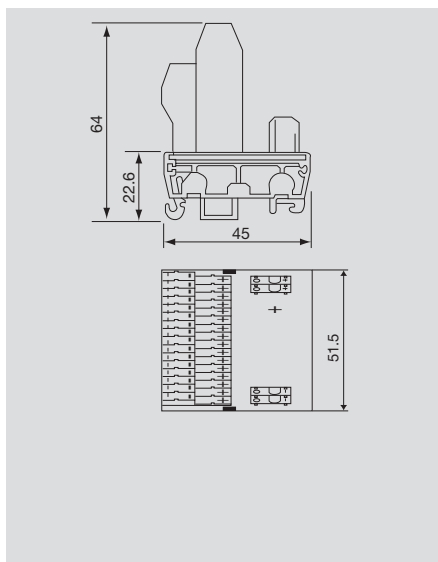
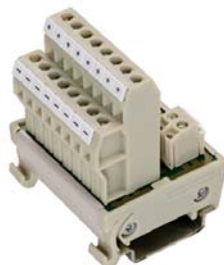

RS VERT 16 LPK2

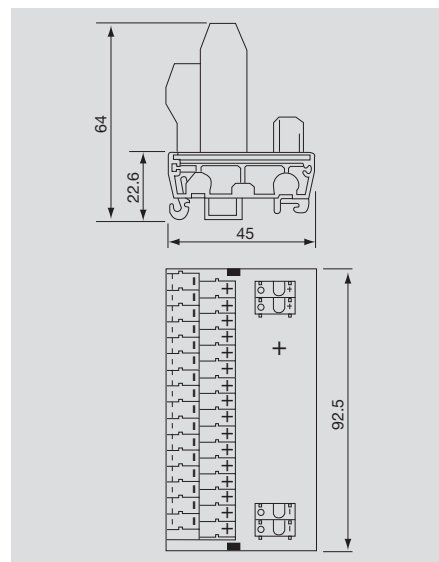
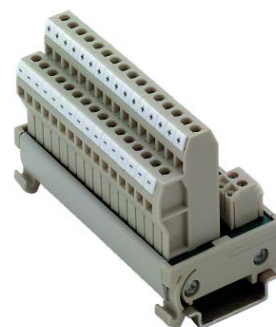

Technical data

Connection data	
Connection on process side	
Stripping length	
Conversion PCB/plug connector	
Rated data	
Rated voltage	
Total current feed, max.	
Electrical distribution, plus/minus	
Storage temperature	
Ambient temperature (operational)	
Housing/Terminal rail	
Insulation coordination (EN 50178)	
Surge category/Pollution severity	
Dimensions	
Clamping range (rating- / min. / max.)	mm ²
Length x width x height	mm
Note	

PCB terminal LPK 2/ Screw connection	
7.0 mm	
8-way supply voltage distributor +/- / 2-pole feed	
24 V AC/DC	
10 A	
+/- potential	
-40 °C...+60 °C	
0 °C...+55 °C	
RS 45 section /TS 35	
III /2	
1.5 / 0.5 / 2.5	
45 x 51.5 x 64	

PCB terminal LPK 2 / Screw connection	
7.0 mm	
16-way supply voltage distributor +/- / 2-pole feed	
24 V AC/DC	
10 A	
+/- potential	
-40 °C...+60 °C	
0 °C...+55 °C	
RS 45 section /TS 35	
III /2	
1.5 / 0.5 / 2.5	
45 x 92.5 x 64	

Ordering data

Note	
-------------	--

Type	Qty.	Order No.
RS VERT8 LPK2	1	8252010000

Type	Qty.	Order No.
RS VERT16 LPK2	1	8234620000

Supply Voltage Distributor Modules

Supply voltage distributor modules

- Distribution module for 2 supply connections to 72 potential distribution terminals
- Potential distributor designed as three level connection element
- Total current max. 20 A
- For mounting on rail TS 32/35

RS VERT 144 LPK3

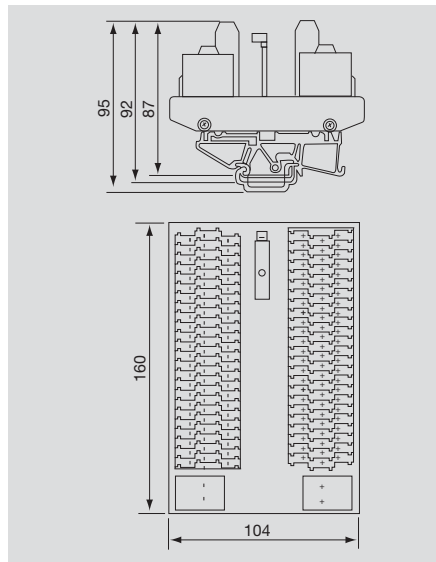
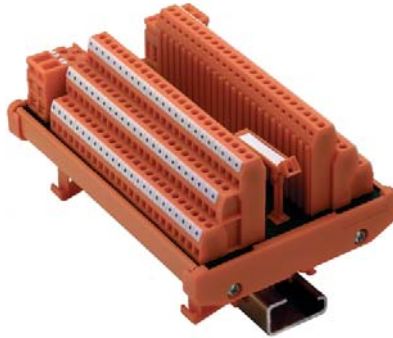

Technical data

Connection data

Connection on process side
Stripping length
Conversion PCB/plug connector

PCB terminal LPK 3 / Screw connection
7.0 mm
72-way supply voltage distributor +/- / 2-pole feed

Rated data

Rated voltage
Total current feed, max.
Electrical distribution, plus/minus
Storage temperature
Ambient temperature (operational)
Housing/Terminal rail

250 V AC/DC
20 A
+/- potential
-40 °C...+60 °C
0 °C...+55 °C
RS 100 section /TS 32, TS 35

Insulation coordination (EN 50178)

Surge category/Pollution severity

III / 2

Dimensions

Clamping range (rating- / min. / max.) mm²
Length x width x height mm

1.5 / 0.5 / 2.5
104 x 160 x 87

Note

Ordering data

Type	Qty.	Order No.
RS LPK3/144 VERT	1	8199510000

Note

Interface units with RJ45 plug connectors

- Direct coupling of PC and modem in control cabinet
- Connection of typical office equipment
- Data rate Cat5 100 Mbit
- Available as RJ 45/screw connection conversion or as RJ 45 coupling
- For mounting on rail TS 32/35

RS RJ45



RS RJ45 2WAY

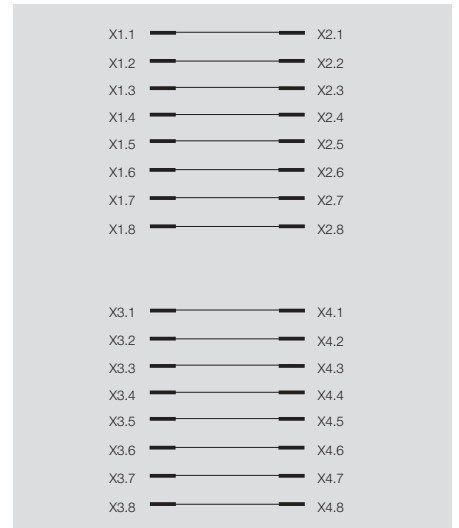
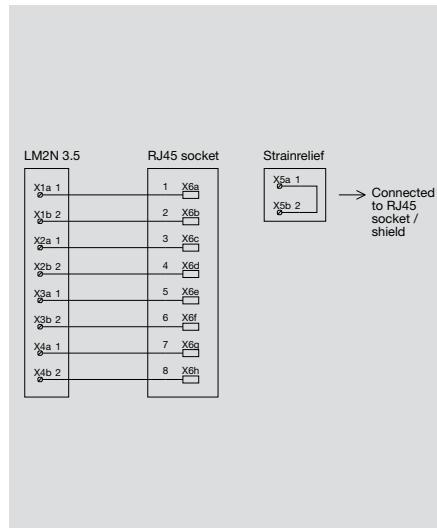

Technical data

Connection data	
Connection on process side	
Connection on control side	
Design	
Conversion PCB/plug connector	
Rated data	
Rated current per connection	
Number of signals	
Contact material	
Storage temperature	
Ambient temperature (operational)	
Housing	
Terminal rail	
Insulation coordination (EN 50178)	
Surge category/Pollution severity	
Dimensions	
Clamping range (rating- / min. / max.)	mm²
Length x width x height	mm
Note	

screw connection/ RJ45 plug-in connector	
screw connection/ RJ45 plug-in connector	
RJ45 female connector	
1:1	
1.5 A	
8 shielded	
phosphor- bronze 6µ AU	
-40 °C...+70 °C	
0 °C...+55 °C	
RS 70 section	
TS 32, TS 35	
II / 2	
1.5 / 0.5 / 1.5	
70 x 30 x 48	
Connect shielding of data line to protective ground at one end	

2 x RJ45 connector	
2 x RJ45 connector	
RJ45 female connector	
1:1, RJ45 coupling	
1.5 A	
8 shielded	
phosphor- bronze 6µ AU	
-40 °C...+70 °C	
0 °C...+55 °C	
RS 70 section	
TS 32, TS 35	
II / 2	
70 x 38 x 48	
Connect shielding of data line to protective ground at one end	

Ordering data

Type	Qty.	Order No.
RS RJ45	10	8611320000
RJ 4A		912171
RJ 6A		911915
RJ 8A		911916
Note		

Type	Qty.	Order No.
RS RJ45 2WAY	1	855440000
Note		

ELCO Interface Unit

Cable interface units designed according to UL 508A recognition

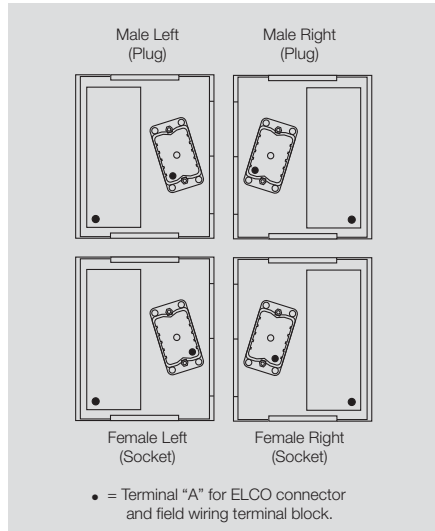

ELCO

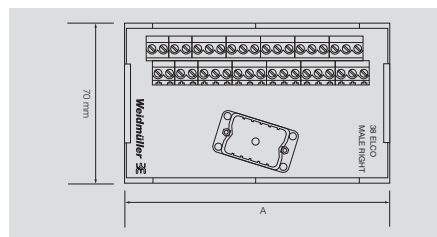
Male† connector
Standard

ELCO

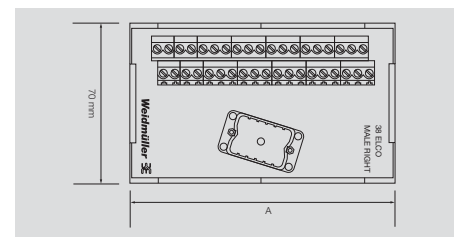
Female† connector
Standard

Technical data

Connection data

- Process side
- Type
- Control side
- Type

Rated data

- Rated voltage
- Rated current per contact
- Operating temperature
- Storage temperature

Terminal wire size

Insulation stripping length mm (in.)

Dimensions

Overall width mm (in.)

- Screw connection
- LP2N terminal
- Plug connection
- ELCO

- 125 V
- 3.5 A
- 25°C...+50°C
- 40°C...+70°C

AWG 26...12

7 (.28)

See table, dim. A

- Screw connection
- LP2N terminal
- Plug connection
- ELCO

- 125 V
- 3.5 A
- 25°C...+50°C
- 40°C...+70°C

AWG 26...12

7 (.28)

See table, dim. A

Ordering data

dimensions (mm/in.)

Poles	Cable			Dim. A
	Connector Orientation*	Connector Retainer	Connector	
38	Left	Center Screw		119.63 (4.71)
38	Right	Center Screw		119.63 (4.71)
56	Left	Center Screw		174.75 (6.88)
56	Right	Center Screw		174.75 (6.88)

Type	Order No.
Male	
RS-ELCO 38 M/L	912126
RS-ELCO 38 M/R	912127
RS-ELCO 56 M/L	912131
RS-ELCO 56 M/R	912132

Type	Order No.
Female	
RS-ELCO 38 F/L	912128
RS-ELCO 38 F/R	912129
RS-ELCO 56 F/L	912133
RS-ELCO 56 F/R	912134

Accessories

Mounting rail

End bracket for TS 32
for TS 35

Note :

*The purpose for the different designations, "left" and "right" are relative to the direction the interconnecting cable is plugged into the interface module. ELCO connector cables generally use #14 AWG wire which does not bend easily.

Type	Order No.
TS 32	0122800000
TS 35 x 7.5	0383400000
TS 35 x 15	0498000000
EWK 2	0199360000
EW 35	0383560000

The angled connector reduces the side load torque on the cable connector and printed circuit board by guiding the cable on an angle to the wire duct.

Type	Order No.
TS 32	0122800000
TS 35 x 7.5	0383400000
TS 35 x 15	0498000000
EWK 2	0199360000
EW 35	0383560000

†Designates plug (S – male) or socket (B – female) connector on the interface module.

Multi-pole cable connector for SCSII applications

T-CON

Female connector with accessory holes

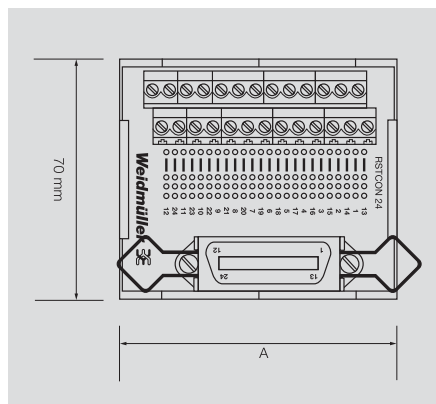

Technical data

Connection data

- Process side
- Type
- Control side
- Type

- Screw connection
- LP2N terminal
- Plug connection
- T-Con

Rated data

- Rated voltage
- Rated current per contact
- Operating temperature
- Storage temperature

- 60 V
- 100 mA
- 25°C...+50°C
- 40°C...+70°C

Terminal wire size

Insulation stripping length mm (in.)

AWG 26...12
7 (.28)

Dimensions

Overall width mm (in.)

See table, Dim. A

Ordering data

dimensions (mm/in.)

Poles	Connector Retainer	Dim. A
50	Bale Latch	149.35 (5.88)

Type **Order No.**

RS-TCON 50 AF	912201
---------------	--------

Accessories

Mounting rail	
End bracket	for TS 32 for TS 35

Type	Order No.
TS 32	0122800000
TS 35 x 7.5	0383400000
TS 35 x 15	0498000000
EWK 2	0199360000
EW 35	0383560000

Note :

X-ON Electronics

Largest Supplier of Electrical and Electronic Components

Click to view similar products for [Weidmuller manufacturer:](#)

Other Similar products are found below :

[8924550000](#) [56956](#) [0133660000](#) [6720000227](#) [6720005111](#) [68676](#) [69718](#) [EXO24CH](#) [7940000218](#) [8005181001](#) [8008180000](#) [8432240000](#)
[8463580000](#) [8545830000](#) [8689870000](#) [8705640000](#) [8869870000](#) [9001080000](#) [9003720000](#) [9004250000](#) [9004780000](#) [9008380000](#)
[9013260000](#) [9014100000](#) [9019040000](#) [9025430000](#) [9026010000](#) [9028630000](#) [9032010000](#) [903708](#) [9037350000](#) [9046290000](#) [9046380000](#)
[9129643500](#) [913155](#) [9159530000](#) [919656](#) [919764](#) [9202230000](#) [9202850000](#) [9203710000](#) [9204640000](#) [9456750000](#) [9457913000](#) [980811](#)
[980826](#) [9912800003](#) [9916280012](#) [9918380000](#) [9919371205](#)