

# Markers, printers, software

## Industrial marking system

Let's connect.

Version 2021



# Orange Selection

## Quick and easy planning

As a planning engineer, do you want to select products easily and receive them quickly? From a partner you can rely on? Then plan with the Orange Selection from Weidmüller in the future. The Orange Selection items are always available, carefully selected and the portfolio consists of more than 1,500 items to fully cover your standard needs.

If your order is placed before 3:00 pm, we guarantee that your order will be on its way the very next working day.

For even more efficient planning and production processes, we will of course provide all articles in digital form. CAD, ETIM and eClass data are available in our online product catalogue **[catalog.weidmueller.com](http://catalog.weidmueller.com)**

We have summarised all the advantages of the Orange Selection on our website.

Check it out: **[www.weidmueller.com/orange-selection](http://www.weidmueller.com/orange-selection)**



# Markers, printers, software

## Industrial marking system

### Catalogue 7

Markers, printers, software  
Industrial marking system

Introduction

Software

InkJet Printer & MultiCard, MetalliCard

Thermal transfer & MultiMark

Standard printed markers

Accessories

Cabinet Infrastructure

Appendix

Service and support

Index

Index Type / Index Order No.

Contents

A

B

C

D

E

F

G

V

X

# Software M-Print® PRO

## M-Print® PRO

Page B.2



## M-Print® PRO eCAD

Page B.6



# InkJet Printer & MultiCard, MetalliCard

**PrintJet CONNECT**  
Page C.6



**MCP Plus 2**  
Page C.12

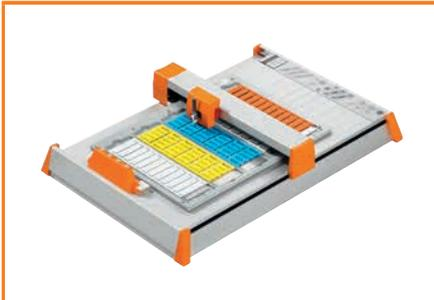

**MCP Basic 2**  
Page C.14

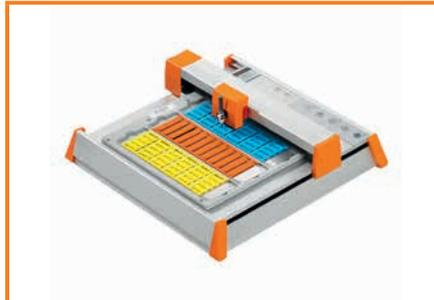

**DEK MultiCard Terminal markers**  
Page C.26



**WS MultiCard Terminal markers**  
Page C.34



**PM MultiCard Terminal markers**  
Page C.48



**ZS MultiCard Terminal markers**  
Page C.50



**MF MultiCard Terminal markers**  
Page C.54



**WAD MultiCard Terminal markers**  
Page C.94



**ELS MultiCard Terminal markers**  
Page C.98



**SF/SFR MultiCard wire and cable markers**  
Page C.106



**SFX MultiCard wire and cable markers**  
Page C.108



# InkJet Printer & MultiCard, MetalliCard

**SFC MultiCard wire and cable markers**  
Page C.110



**TM-I MultiCard wire and cable markers**  
Page C.112



**ELS MultiCard wire and cable markers**  
Page C.114



**MetalliCard wire and cable markers**  
Page C.116



**DMC MultiCard wire and cable markers**  
Page C.124



**ESG MultiCard device markers**  
Page C.126



**SM MultiCard device markers**  
Page C.148



**CC MultiCard device markers**  
Page C.158



**MetalliCard device markers**  
Page C.168



# Thermal transfer & MultiMark

## THM MultiMark

Page D.4



## THM MultiMark PLUS

Page D.6



## Dekafix, WS and MultiFit

### Terminal markers

Page D.10



## TM-I, WM, SFM, SFX, ELS and THM ET

### wire and cable markers

Page D.14

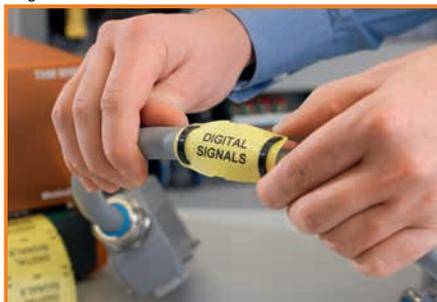

## THM WriteOn wire and cable markers

Page D.20



## shrink sleeves wire and cable markers

Page D.24

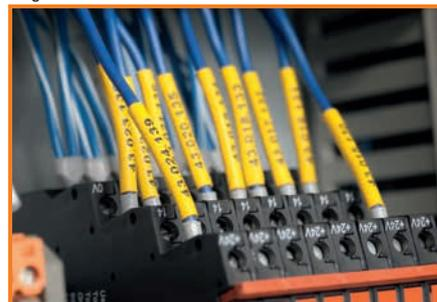

## ESG, SM, CC and EL device markers

Page D.34



## THM und LM device markers

Page D.40



# Standard printed markers

## DEK Karte Terminal markers

Page E.2



## CableLine - CLI C wire and cable markers

Page E.6



## CableLine - CLI O wire and cable markers

Page E.38



## CableLine - CLI M wire and cable markers

Page E.44



## CableLine accessories wire and cable markers

Page E.51



## WSM stainless steel markers

Page E.54



## Labels

Page E.58



## KSW PCB plug-in connector labels

Page E.60

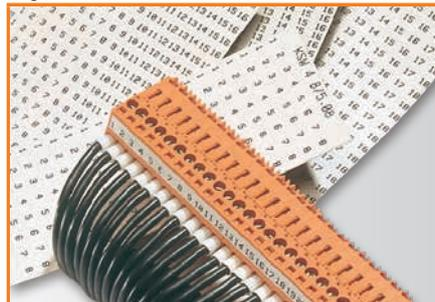



# Accessories

## Tag carriers

Page F.2

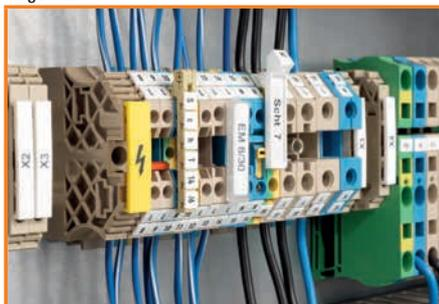

## Transparent sleeves

Page F.10



## WKM

### transparent sleeve for cable tie installation

Page F.16



## Tag rails

### identification for side-by-side devices

Page F.20



# Cabinet Infrastructure

## Filter fans

Page G.2



## Heating solutions

Page G.10



## Thermostats and humidistsats

Page G.14



## Cable ducts

Page G.17



## Accessories cable ducts

Page G.25

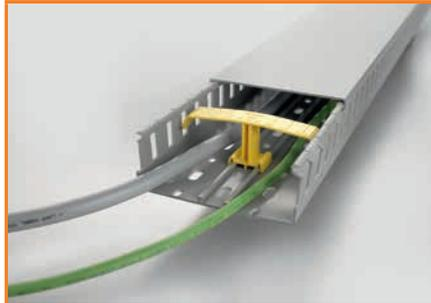

## Cable ties

Page G.30



# Introduction

---

<b>Introduction</b>	Workplace Solution	A.2
	Systemised marking	A.8
	Colour coding with PrintJet CONNECT	A.10
	Materials	A.12
	Weidmüller tests and test procedures	A.14

---

## Ideally equipped for every work phase

### Increase efficiency and save time

**A** The current boom in the sector is opening up new challenges for panel builders. On the one hand, the order books are full, but on the other hand, international competition is increasing, which in turn is leading to increased cost pressure. This dilemma will not be resolved by a single action alone, but rather by the consistent optimisation of the entire panel building process.

With Weidmüller, you have a strong partner by your side to support you in all work phases with perfectly coordinated solutions for your workshop. Based on many years of practical experience in panel building, we offer a comprehensive portfolio to effectively speed up your processes and increase your quality. Take a good look at our tools, markers, printers, software, automated systems and panel infrastructure for all work phases – from planning to installation and finally operation.

## Planning

With our software solutions for marking (M-Print® PRO), semi-automated cable assembly (WPC tool) and configuration (WMC), you are perfectly positioned in every project phase. Thanks to interfaces to your CAE system, you benefit from optimum data consistency from planning through to commissioning.

## Installation

Tools of certified premium quality, intuitive automatic stripping and crimping machines as a stand-alone or semi-automated solution, as well as a coordinated marking system enable you to save time and ensure safe assembly. At the same time, you minimise sources of error. Our end-to-end range is rounded off by versatile installation materials and infrastructure components for the panel. Besides our professional manual tools, we also offer you sets with an appropriate and efficient combination of tools and coordinating accessories, as well as a complete tool chest that has been developed in line with 5S and lean principles.

## Operation

Even after commissioning your panels, the perfect interaction of products and tools from a single source offers you sustainable efficiency gains. Our extensive range of measuring and testing tools provides you with reliable support for troubleshooting. Seamless marking of all panel components as well as digital data consistency simplify and speed up maintenance work. This helps you reduce downtimes and increase the efficiency of your process steps.



## Recognising and harnessing the potential of Industry 4.0

### Smart panel building increases efficiency

In traditional panel building, the product development process comprises numerous manual work steps. This means a high expenditure of resources and time as well as a natural source of error. A study by the University of Stuttgart on the subject of panel building 4.0\* shows that traditional panel builders spend the most time during the planning and installation phases. In other words: The project planning and circuit diagram design work steps tie up more than 50% of the working time during the planning stage. The reason for this is inconsistent engineering processes and increasingly complex requirements as a result of the growing project business. The many manual tasks in mechanical assembly and wiring during the installation stage account for more than 70% of the working time!

#### The biggest time sinks in traditional panel building

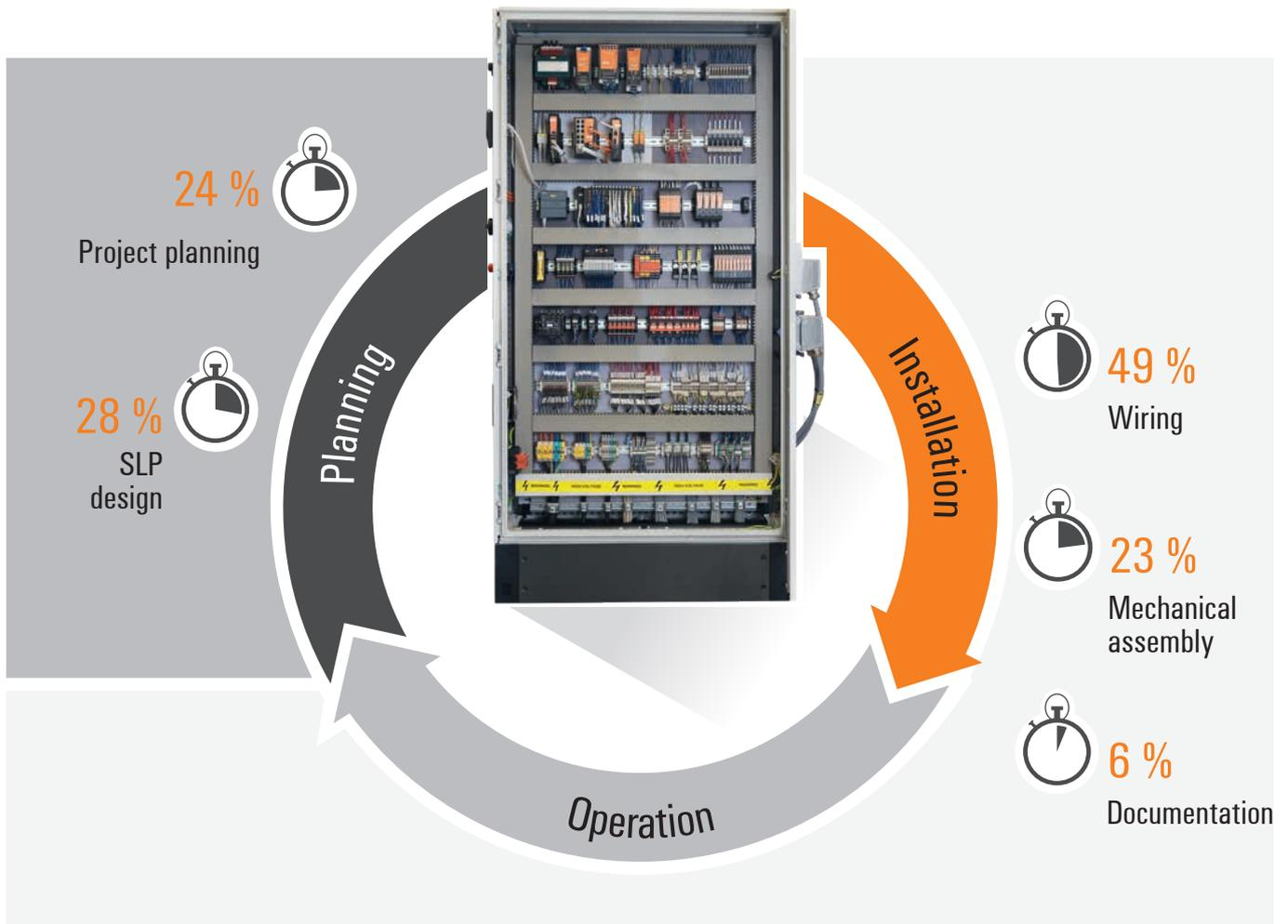

\*University of Stuttgart, Institute for Control Engineering of Machine Tools and Manufacturing Units, „Schaltschrankbau 4.0 – Eine Studie über die Automatisierungs- und Digitalisierungspotentiale in der Fertigung von Schaltschränken und Schaltanlagen im klassischen Maschinen- und Anlagenbau (Panel building 4.0 – A Study of the Potential of Automation and Digitalisation in the Production of Panels and Switching Systems in Traditional Mechanical and Plant Engineering)“.

# Greater productivity in the workshop

## Standardisation and automation

Above all, standardisation, automation and process-wide solutions offer considerable optimisation potential for inconsistent engineering processes and time-consuming, manual activities. At Weidmüller, we have focused very closely on these issues.

The result: A portfolio of complete solutions for the workshop where each work step perfectly flows into the next, and enabling processes to be 80% faster with 100% planning reliability.

### Optimisation potential from Weidmüller



## 80 %

#### Faster and safer processes

We are constantly developing innovations that streamline time-consuming work processes such as mechanical assembly and wiring and that increase your productivity, for example with tools, markers and printers optimally adapted to the application.



## 100 %

#### Premium quality

For over 40 years, Weidmüller has stood for automated systems, tools, markers and printers that meet the highest requirements. Our constantly updated certifications and approvals under all relevant standards speak for themselves – premium products made in Germany that you can rely on.



## 100 %

#### Planning safety

Maximum reliability for your projects. With Weidmüller you have a partner with many years of experience in cable processing and marking – and a partner that you can rely on. By reducing potential sources of error with continuous data consistency, we streamline time-consuming work processes and increase your productivity.



## One Stop Shop

#### Guaranteed availability

Our complete solutions for your workshop are available to you everywhere and at any time thanks to our worldwide network. You can rely on this and on our proven logistical processes. Regardless of the location.

# Cross-process solutions from Weidmüller

### Design

The Weidmüller Configurator (WMC) supports you in planning and configuring your panel, such as with assembled terminal strips. You import data sets from your eCAD system through an interface and simply transfer them back after they have been processed in the WMC.

### Purchasing

The consistent availability of all article and order numbers also applies to our E-shop and speeds up purchasing and reordering.

### Planning

The M-Print® PRO marking software makes it much easier to plan and label markers. With the M-Print® PRO eCAD add-on, you connect your eCAD system with the marking software and perform intelligent automated component marking.

### Service

You benefit from the perfect interaction of our integrated portfolio, even during and after the commissioning of your panels. Seamless marking of all panel components as well as digital data consistency simplify and speed up maintenance work. This helps you reduce downtimes and increases the efficiency of the entire application.

### Mechanics and electronics in partnership:

High-quality and certified measuring and testing tools facilitate the final testing of panels and always deliver reliable measured values.





### Warehousing

The markers of our MultiCard system are compatible with components such as terminal blocks, conductors, cables and devices from all manufacturers. Our MultiCard markers are available in almost 700 designs and can be individually printed. This reduces the number of marker variants that you always have to keep in stock.

### Mechanical work preparation

Our comprehensive range supports you in all phases of work preparation, such as with the required panel infrastructure as well as cutting and perforation tools for the mechanical preparation of your panel components.

### Electrical work preparation

Our automated systems carry out repetitive tasks for you, such as the cutting to length, stripping and crimping of cables. The marking software M-Print® PRO directly controls printers such as the PrintJet CONNECT or the THM MultiMark and ensures that the right marker is printed for every component and every cable.

As stand-alone solutions or as a semi-automated Wire Processing Center (WPC) with your own planning software – our systems offer you maximum application flexibility.

### Workshop/design

Error sources are reduced in installation and commissioning thanks to the clear and transparent marking of all cables and components. Weidmüller's manual tools for cutting, stripping, crimping, testing and screwing offer you a great deal of efficiency through precision, high quality and ergonomic design. The semi-automated Wire Processing Center (WPC) enables individual process optimisation with significantly increased efficiency.

### Commissioning/testing

Your safety is the top priority when it comes to commissioning electrical systems and devices. Weidmüller's voltage and continuity testers comply with all relevant standards and you have peace of mind that your tests are performed in accordance with the regulations.

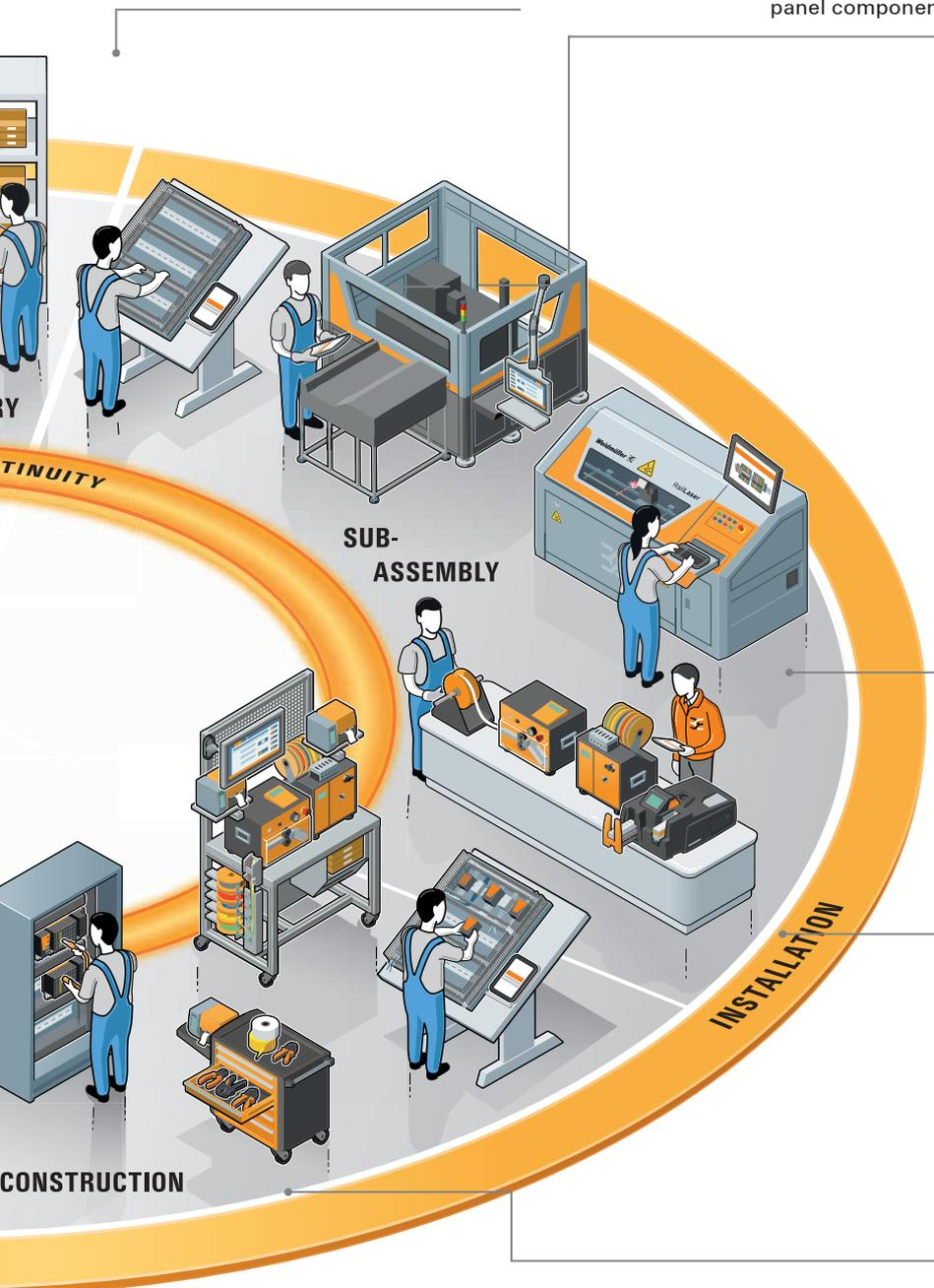

# Systemised marking for optimised processes

## Our co-ordinated complete system



Professional, industrial marking in line with the IEC 60204-1 standard is essential for faultless operation and reliable maintenance of industrial facilities. Weidmüller calls this “systemised marking” and offers more than the norm: a perfectly co-ordinated product range for optimised processes.



## Software



intuitive to use and tailored to your requirements. Import, edit and manage data with ease with the M-Print® PRO software.



Do you need marking systems for a whole range of different applications? Our all-in-one solutions are intelligent and display real future viability: convenient data organisation, intelligent functions and marking conforming to standards make our systems unique.



## Your marking needs

One of the main requirements of a marking system is that it clearly shows how your components are configured. This includes a precise print image, convenient handling and the guarantee of usability in an industrial environment. The software should provide optimum support during data entry and management. During marker output, the speed should be adapted to your needs.



## Markers

constructive solutions for all cabinet-related applications. From the shrink sleeve to the metal marker.



## Printers

laser, ink or thermal transfer. Industrial printing systems for every requirement. Designed with one eye on the future to suit your requirement profile



## The marking result

You will be won over by marking systems from Weidmüller. We don't just offer you a complete, convenient process chain from data entry to ready-for-use markers for your individual cabinet configuration. We offer you marking solutions that are already geared towards the future requirements of progressive automation. This means you are one step ahead of state-of-the-art!

## Colour coding, only with PrintJet CONNECT

**Relevant standards specify the need for colour coding in order to clearly identify different components, such as wires or push buttons. Coloured markings can be applied accurately and securely with the PrintJet inkjet printer from Weidmüller, which has a highly superior colour-printing capability.**

The marking of components, sub-assemblies, devices, wires and connectors within your electrical system means that you will have clear identification throughout its entire life cycle. As a result, service and maintenance work is made significantly easier and potential faults can be quickly located and immediately eliminated.

Clear identification of electrical equipment and systems is obligatory, as defined in relevant standards such as DIN EN 60204-1, entitled "Safety of machinery - Electrical equipment of machines - Part 1: General requirements". To ensure that the markings have the best visibility, these and other standards recommend colour coding, in most cases.

### Fast and accurate recognition of warning and hazard information through colour coding

In contrast to black and white printing, colour coding enables faster and more accurate recognition of the type of information that the marking is in place to convey. This is of particular significance when it applies to warning and hazard information. For example, due to its colour symbolism, the colour red indicates: "Warning – there is a possible hazard here". Accordingly, DIN EN 60204-1 states that "the colour RED [...] shall be used for EMERGENCY STOP and EMERGENCY OFF controls". Other colours, such as yellow, blue or green, are specified for various other

conditions. In addition to the compulsory colour coding, the standard recommends "identifying push buttons in the vicinity of the control panel, or preferably directly on the control panel, with [corresponding] symbols [...]" to prevent any confusion.

"Wherever colours are used to identify wires, use of the colour throughout the length of the wire is recommended, either through the colour of the insulation or through coloured markings at regular intervals, at the ends, or in accessible locations." (DIN EN 60204-1). Again, defined colours are specified for certain types of conductor in this case, e.g. green/yellow for PE wires or light blue for neutral wires.

### High definition and in colour

In these cases, where colour coding is required, you will benefit from the unique characteristics of our PrintJet CONNECT inkjet printer which delivers high-definition, colour printing of texts, frames, lines, graphics, barcodes, serial numbers and photos. The major advantage is that only white markers are needed and that they can be printed with a total of 256 different colours. A marker can be printed using any number of different inks, without having to use individual matte colours. M-Print® PRO, our software for printing and ordering labels and markers, can be used



to fully customise each marker before printing it with the PrintJet CONNECT printer.

This system requires significantly fewer article numbers than when using colour markers, which are often only available as special orders. The effort involved in ordering and stocking is therefore considerably reduced. This enables standard-compliant coding in a time-saving and cost-efficient manner - for fast and accurate identification.

#### Overview of particular standards which specify or recommend colour coding:

- **DIN EN 60204-1** (Safety of machinery - Electrical equipment of machines - Part 1: General requirements)
- **IEC 60445** (Identification of equipment terminals, conductor terminations and wires)
- **IEC 60446** (Basic and safety principles for man-machine interface - Identification of wires by colours or alphanumeric)
- **DIN EN 50174-2** (Information technology - Cabling installation - Part 2: Installation planning and practices inside buildings)



# Materials

Material	Thermal, mechanical characteristics	Chemical characteristics
<b>Polyamide 66 (PA), UL 94-V2</b>	Hard, rigid, abrasion-resistant halogen-free, -40 °C...+100 °C	<b>Resistant to:</b> oils, benzene, benzene, alkalis, solvents, chlorinated hydrocarbons, esters and ketones <b>Not resistant to:</b> ozone, hydrochloric acid, sulphuric acid, hydrogen peroxide
<b>Polyethylene LD (PE), UL 94-HB</b>	Soft, cold-resistant to -40 °C, impact-resistant, unbreakably rigid, transparent to opaque halogen-free, -40 °C...+80 °C	<b>Resistant to:</b> acid, alkalis, solvents, alcohol, benzene <b>Not resistant to:</b> aromatics, chlorinated hydrocarbons
<b>Polyvinyl chloride, hard (PVC), UL 94-V0</b>	Hard, rigid, transparent to opaque -50 °C...+80 °C	<b>Resistant to:</b> acid, alkalis, oils, greases, benzene <b>Not resistant to:</b> benzene, ketones, esters and stain removers
<b>Polyvinyl chloride, soft (PVC), UL 94-V0</b>	Hard, rigid, transparent to opaque -40 °C...+80 °C	<b>Resistant to:</b> acid, alkalis, oils, greases, detergents <b>Not resistant to:</b> benzene, esters and chlorinated hydrocarbons
<b>Polypropylene (PP)</b>	Hard, rigid, transparent to opaque -40 °C...+80 °C	<b>Resistant to:</b> acid, alkalis, saline solutions, alcohol, oil <b>Not resistant to:</b> chlorinated hydrocarbons
<b>Polyolefine</b>	Shrinkage rate 2:1 at 90 °C halogen-free, -55 °C...+105 °C	<b>Resistant to:</b> acid, alkalis, solvents, alcohol, benzene <b>Not resistant to:</b> aromatics, chlorinated hydrocarbons, diesel
	Fire-retardant Shrinkage rate 3:1 at 90 °C -55 °C...+135 °C	<b>Resistant to:</b> acid, alkalis, solvents, alcohol, benzene, saline solutions, alcohol, oil <b>Not resistant to:</b> aromatics, chlorinated hydrocarbons, diesel, chlorinated hydrocarbons
	halogen-free, Non-shrinking -55 °C...+105 °C	<b>Resistant to:</b> acid, alkalis, solvents, alcohol and petrol <b>Not resistant to:</b> aromatic compounds, chlorinated hydrocarbons and diesel
<b>Polyoxymethylene (POM)</b>	Hard, rigid, impact-resistant to -40 °C, unbreakable, high dimensional stability in heat, high abrasion resistance, low moisture absorption -40 °C...+80 °C	<b>Resistant to:</b> weak acids, weak alkalis, benzene, benzene, alcohols, oils <b>Not resistant to:</b> strong acids and strong alkalis
<b>Vinyl-coated cotton fabric</b>	Halogen-free -29 °C...+80 °C	<b>Resistant to:</b> good resilience to water, oils and various solvents as well as alcohols and benzene
<b>Polyester material</b>	Halogen-free -40 °C...+150 °C	<b>Resistant to:</b> very good resilience to water and weathering effects, good resistance to petroleum-based solvents, moderate resistance to esters and ketones, very good resistance to UV radiation
<b>Polyurethan</b>	Flexible -40 °C...+90 °C	<b>Resistant to:</b> alcohols, solutions of organic salts, aromatic hydrocarbons, mineral oil, greases <b>Not resistant to:</b> acid, alkalis and chlorinated hydrocarbons

Material	Thermal, mechanical characteristics	Chemical characteristics
<b>Polyvinyl fluoride</b>	Dimensionally stable, abrasion-resistant, thermally stable -40 °C...+140 °C	<b>Resistant to:</b> very good resilience to water and weathering effects, good resistance to petroleum-based solvents, moderate resistance to esters and ketones, very good resistance to UV radiation
<b>Thermoplastic polyurethane (TPU)</b>	Halogen-free, flexible -40°C...+90°C	<b>Resistant to:</b> alcohol, petrol, cleaning solutions, butanol, ethyl and butyl cellosolve solvents
<b>Stainless steel 1.4301</b>		The 1.4301 steel is resistant to water, water vapour, humidity, food acids, as well as weak organic and inorganic acids and offers a range of diverse applications, e.g. in the foodstuff industry, in beverage production, in the pharmaceutical and cosmetic industry or in chemical equipment engineering.
<b>Stainless steel 1.4404</b>		The 1.4301 steel is resistant to water, salt water, chlorine-containing media, water vapour, humidity, food acids, as well as weak organic and inorganic acids and offers a range of diverse applications, e.g. in the foodstuff industry, in beverage production, in the pharmaceutical and cosmetic industry or in chemical equipment engineering.
<b>Aluminium</b>		Protected through passivation to protect reactions with air or water at room temperature. Inexpensive and light alternative to stainless steel.

# Weidmüller tests and test procedures

Tests	Test conditions/requirements
<b>Materials test</b>	Flammability in accordance with UL 94 Shore A hardness test A - ISO 868 Surface resistance - DIN IEC 60093
<b>Ageing</b>	All marker materials are tested for their ageing resistance. Tested to Weidmüller test specifications.
<b>Function test of PTFE and PVC wire insulation</b>	Suitability of markers for installation at temperatures between -10 °C to +40 °C. Correct attachment test of the respective marker size for the smallest to the largest wire diameter.. Tested to Weidmüller test specifications.
<b>Vibration resistance on carrier</b>	Vibration test, industry, in accordance with: DIN EN 60068-2-6, sinusoidal (3 axes, 10 cycles per axis, acceleration 5g, frequency 10-500 Hz, sweep rate 1 octave/minute) Tested to Weidmüller test specifications.
<b>Wipe resistance</b>	Resistance of the print against the effects of hand perspiration, machine oil, water and ethanol. A slight alteration is permissible; however, clear identification (legibility) must be guaranteed. In the case of printing subject to VDE 0611 pt 4 (rating plate details), the wipe resistance against water and mineral spirits is to be tested for a period of 15 minutes.  Standards: DIN VDE 0611-4 / Pt. 3.1.3 DIN EN 60947-1/ Pt. 5.1 DIN EN 60742, CEI 16-7 Tested to Weidmüller test specifications.
<b>Scratch resistance</b>	No scratches may be visible on the base or the carrier following the fingernail test. A slight alteration is permissible; however, clear identification must be guaranteed. Tested to Weidmüller test specifications.
<b>UV light resistance</b>	The function must be guaranteed. The print or colour of the product must be clearly recognisable. Standard: DIN EN ISO 4892-2; Tested to Weidmüller test specifications.
<b>Chemical resistance of the print</b>	Tested to Weidmüller test specifications.

We would like to point out that the described test procedures are implemented depending on type and application. Owing to the sheer number of possible applications and environmental influences such as moisture, radiation, gases or heat/cold to which the products can be exposed, Weidmüller accepts no liability for the suitability of products in all customer applications. Suitability tests for specific applications must therefore be carried out by the customer. However, Weidmüller will be happy to provide help and advice upon request.

Due to the different identification system available on the market, we wish to point out that Weidmüller does not guarantee industrial identification products if the Weidmüller components (markers - transparent sleeves - ink/toner/colour ink ribbons - printing systems) are combined with third-party products, unless Weidmüller has explicitly agreed for the purpose of an individual application.







# Software

---

<b>Software</b>	M-Print® PRO	B.2
	M-Print® PRO eCAD	B.6

---

# M-Print® PRO

## Flexible, project-specific, and globally applicable

M-Print® PRO is available in 20 different languages. Thanks to the graphical user interface, the software is particularly easy to use. It is compatible with various data formats and interfaces of eCAD programs and has a practical import function. M-Print® PRO makes it possible to create printings for different markers, e.g. MultiCard, MultiMark, MetalliCard, Label Processing tags and Sheets in one project. Weidmüller printers are controlled via USB port or network connection. You can also order pre-printed markers with M-Print® PRO directly online from us.

## Benefits at a glance



### Efficient

The complete integration into your processes saves time and money



### Intuitive

Intuitive and easy to use thanks to graphical user interface (WYSIWYG)



### Multilingual

The software is available for Windows® in 20 languages

## All in one: the simplest marking system

Systemised marking is based upon the foundation of the intuitive software M-Print® PRO. With a single software package, it is possible to produce marking and signage for all applications conforming to the industry standards. Alongside the dependable data achieved by failure free data transfer, process optimisation is a key benefit. This optimisation is achieved via the conglomeration of marker, printer, and data transfer all with a single system. Then you will be prepared for all eventualities regarding the panel engineering process.



- Professional software package for marking electrical components
- Local and network installation
- Digital support of the entire marking process
- Optimal project creation. Complex project tasks in a single project file and templates for future projects
- Continuous and double-sided labelling (heat shrinks)
- Consecutive numbering function
- Data import of different file formats and eCAD interfaces
- Integrate graphics, barcodes, and symbols
- Integrated product catalogue containing the complete range of Weidmüller markers

**Data transfer for optimised processes**

Excel formats can be opened and imported. Defined import steps for routine operations. eCAD interface for a seamless digital process from beginning to end with M-Print® PRO eCAD.

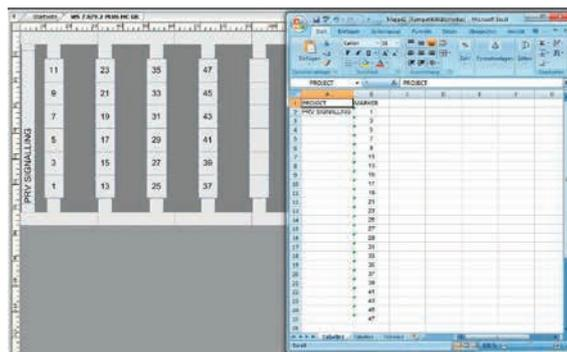

**Easy-to-use editing for rows and sequences**

Endless marking for cost efficient printing. Automatic text and number sequences for continuous marking. Generate consecutive numbering by functions.

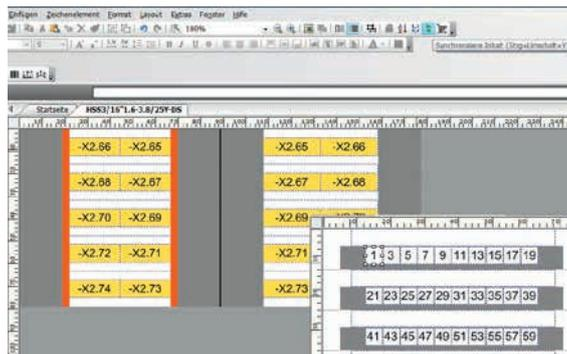

**Graphic functions for complex applications**

Large range of graphic tools and usable formats. Optimal formatting with automatic sizing option. Functions for colour codes and multi-level terminals. Template function for type labels.



**M-Print® PRO**

**Print and ordering software for markers and labels**

M-Print® PRO is a professional software tool for printing and ordering Weidmüller markers and labels under Windows®. This software helps you to optimise your processes for marking electrical equipment. You can design, print and order your marking materials effortlessly, professionally and quickly: texts, frames, lines, graphics, barcodes, serial numbers and photos.



**Technical data**

**Here is an overview of the main functions**

- Integrated product catalogue for all labels and markers, including images and links to the relevant web pages
- Custom formatting of individual text characters (RTF)
- Perform copy-and-paste functions with texts and their formats
- Supports UNICODE for foreign-language texts, such as Russian, Chinese, Polish, etc.
- Enter data on labels or worksheet
- Creation of scales; numeric and alphanumeric counts and sequences
- Extensive range of image formats (\*.bmp, \*.wmf, \*.png, \*.ico, \*.jpeg, \*.tif, \*.gif)
- Image library including all the important symbols used in electrical engineering
- Permanent print preview: see what the printout will look like even at the design phase, WYSIWYG editing
- Output devices supported: Weidmüller marking systems as well as standard printers with Windows® drivers
- Imports data from CAE systems
- Import wizard for a number of file formats (\*.txt, \*.csv, \*.xml, etc.) for creating your own import scripts
- Multi-level structuring of markers and labels
- Interface to Weidmüller configurator

**Hardware**

CPU	Intel CPU (32 or 64 bit)
Processor	min. 1.2 GHz processor clock
Printer communication	USB or IPV4 network (depending on the printing system used)
Working memory	1 GB (more memory is recommended depending on the size of the project files) Hard disk space (without user files): - approx. 300 MB (1 language installed) - for multilingual installation: hard disk space depends on the number of installed languages, max. 2 GB
Screen resolution	min. 1024x768 pixels
Operation	mouse, keyboard
Installation	DVD drive or installation via file storage (e.g. file server, USB stick)
Internet access	Optional, only if updates or access to the Weidmüller product catalogue are required. Not necessary for marking/printing.

**Interface to printer system**

USB, LAN

**Supported operating systems**

Windows® 7, Windows® 8, Windows® 8.1, Windows® 10 (incl. version 1809)

**Virtual environment or terminal server**

Are possible for the use of M-Print® PRO, as long as they meet the above-mentioned operating systems and hardware requirements in full. However, it is recommended to install a trial version (30 days) to verify this in individual cases.

**Ordering data**

<b>Type</b>		<b>M-Print® PRO</b>
M-Print® PRO		<b>Order No.</b> <b>1905490000</b>
M-Print® PRO Online	www.weidmueller.com/MPP-Online	



# M-Print® PRO eCAD

## The clever add-on for your electrical engineering software

In conjunction with the M-Print® PRO software and electrical engineering tools, the interface M-Print® PRO eCAD integrates reference labelling into the entire product development process. This means the interface makes a valuable contribution to increasing quality, accelerating market readiness, and ensuring more satisfied customers despite reduced development costs.

### Benefits at a glance



#### Quality and reliability

M-Print® PRO eCAD makes it possible to label all the parts within the panel. That guarantees a high quality documentation.



#### Efficient

Savings potential through data consistency in the marking process up to 60%.



#### Simple

Setup, installation and commissioning run smoothly as functional dependencies are clearly visible.

### The correct marker for every application

With M-Print® PRO eCAD, the appropriate markers are assigned to terminal blocks, devices, and cable types to ensure a standardised marking system. As a fixed element of the technical documentation, a complete print data is available for the workshop - manual data input is no longer necessary. Thanks to the routine checks of the CAE system, the data is complete and failure free.

- Print® PRO eCAD offers higher quality and reduces the „Time-to-Value“
- A continuous data flow improves the marker process
- Orientation in the cabinet made easy
- Procurement, installation, and commissioning with integrated marker data

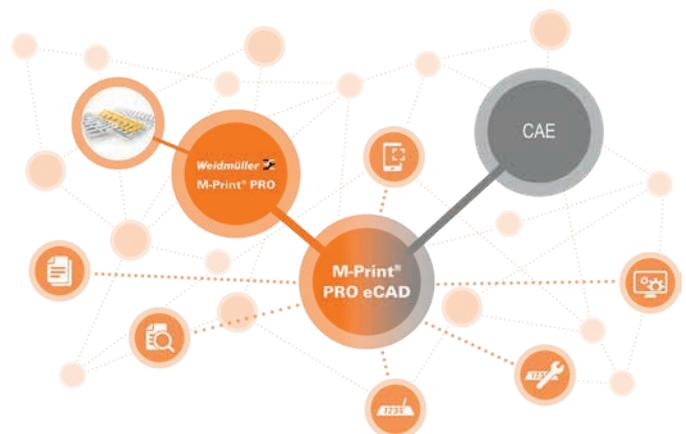



### Perfectly prepared for the follow-on processes

A well planned marking system helps service specialists to quickly identify the various components within the panel. M-Print® PRO eCAD allows technicians to work quicker and more efficiently to avoid failures. The Weidmüller interface connects your CAE software with our marking software M-Print® PRO and guarantees a continuous data flow. With all these benefits, you increase quality and project efficiency, achieve higher project throughput, and increase your margins.



### Download M-Print® PRO eCAD



You can find more information how to download M-Print® PRO eCAD for EPLAN Electric P8 and Zuken E3 und WSCAD on our homepage:

[www.weidmueller.com/mppecad](http://www.weidmueller.com/mppecad)





# InkJet Printer & MultiCard, MetalliCard

<b>InkJet Printer &amp; MultiCard, MetalliCard</b>	Introduction	C.2
	Klippon® Automated RailLaser – Fast and high-precision marking	C.4
	PrintJet CONNECT – the advanced inkjet printer for the highest standards	C.6
	MCP Plus 2 – plotter for low marking requirements	C.12
	MCP Basic 2 – mobile and light plotter	C.14
	Reasons to choose MultiCard	C.16
	Terminal markers	C.18
	DEK MultiCard – markers for terminals and connectors	C.26
	WS MultiCard – markers for the universal range for Klippon® Connect	C.34
	PM MultiCard – markers for compact plug-in connectors	C.48
	ZS MultiCard – markers for Z series modular terminals	C.50
	MF MultiCard – markers for use with other makes of terminals	C.54
	WAD MultiCard – connector markers for terminal and endbrackets	C.94
	ELS MultiCard – inlay tags	C.98
	Wire and cable markers	C.102
	SF/SFR MultiCard – open wire and cable markers	C.106
	SFX MultiCard – cable markers with cable tie feed-through	C.108
	SFC MultiCard – clip technology for wires and cables	C.110
	TM-I MultiCard – inlay tags	C.112
	ELS MultiCard – inlay tags	C.114
	MetalliCard – individual processing	C.116
	Markers for devices and installations	C.120
	DMC MultiCard – equipment identification via wire and cables	C.124
	ESG MultiCard – cross-manufacturer equipment identification	C.126
	SM MultiCard – marker system for control and signalling devices	C.148
	CC MultiCard – identification of electrical installations and switchgear	C.158
	MetalliCard – individual processing	C.168

# Marking systems

The Weidmüller marking systems can be used to quickly and reliably label terminal block markers, wire and cable markers, device markers and labels.

The M-Print® PRO software enables rapid and easy identification of your electrical equipment. The Weidmüller printers PrintJet CONNECT, MCP Plus 2 plotter, MCP Basic 2 plotter and the thermal transfer printers are available for printing.

## C



**PrintJet CONNECT**

The PrintJet CONNECT is part of the Weidmüller marking system consisting of software, markers and printers. It has an extremely durable industrial print head and has been specially optimised for fast working speed and high throughput.

**MCP Plus 2**

The MCP Plus 2 is suitable for lesser marking requirements, with frequent part-labelling and residual material processing. It enables processing to be increased by 20 % in comparison with similar systems.

**MCP Basic 2**

The portable MCP Basic 2 plotter is suitable for lesser marking requirements, part-labelling and processing residual quantities directly, on site.

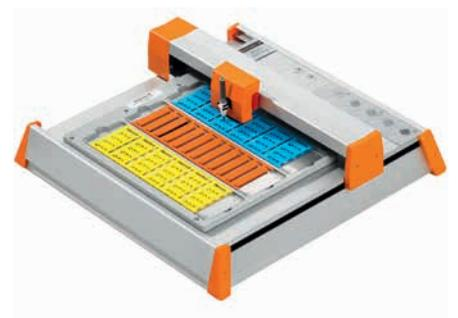
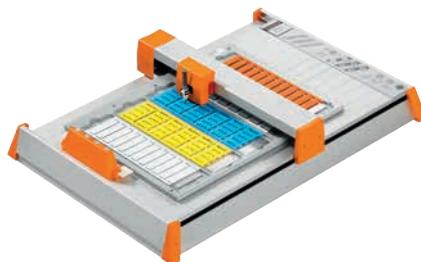

Weidmüller's inkjet printers can be used to quickly and reliably label terminal block markers, device markers, wire and cable markers. The **M-Print® PRO** software enables rapid and easy identification of your electrical equipment. You can design, print and order your marking materials professionally and quickly. Frames, barcodes, graphics and photos are easy to incorporate. The versatile data conversion routines enable quick and flexible data integration. The Weidmüller printers **PrintJet CONNECT**, **MCP Plus 2** and **MCP Basic 2** are available for printing.

The **PrintJet CONNECT** sets a benchmark for industrial identification thanks to its high-quality printing and excellent smudge and scratch resistance. The **MCP Plus 2** plotter offers a high level of flexibility; with just one mounting plate you can print more than 270 different marker types in MultiCard format.

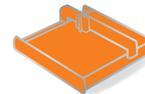
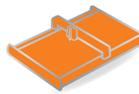

Type of marker	Printer		
	PrintJet CONNECT	MCP Plus 2	MCP Basic 2
<b>Technical data</b>			
Technology	Inkjet process	Plotting technique	Plotting technique
Voltage	AC 230 V / AC 115 V	AC 230 / AC 115 V	AC 230 / AC 115 V
Resolution	300 dpi, 600 dpi, 1200 dpi		
Interfaces	USB, LAN, WiFi	USB	USB
Network card	●		
Order No.	2715590000	2438510000	2438520000
<b>Terminal markers</b>			
DEK/WS/ZS/MF	●	●	●
ELS	●	●	●
WAD	●		
<b>Cable and wire markers</b>			
SF/SFR/SFX/SFC	●	●	●
TM-I	●	●	●
ELS	●	●	●
SFX-M	●		
<b>Device markers</b>			
DMC	●	●	●
ESG	●	●	●
SM/CC	●	●	●
CC-M	●		

# Gain a competitive edge with innovative technology

## Our leading system for fully automatic terminal strip marking



Perfect for  
**500,000**  
markers  
per Year



### Robust marking

The Klippon® Automated RailLaser labels the markers directly. In this way, even the highest requirements for wipe and scratch resistance are met. The high-resolution quality ensures sharp contours and good legibility – even with the smallest markings.



### Matching assortment

Based on Weidmüller's standard markers, the Klippon® Connect A-Series offers a suitably matched portfolio of pre-assembled markers. This enables the full saving potential of the Klippon® Automated RailLaser.

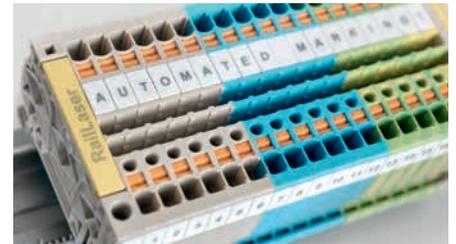

### Universal labelling options

Due to the innovative laser technology, no special markers are required for the Klippon® Automated RailLaser. In addition to the pre-loaded white markers, the markers from Weidmüller's standard portfolio with their wide range of colors and materials can also be used.



### Highest performance

The innovative interaction of software, sensor technology and laser system ensures fast, high-precision marking results. Time savings of up to 90 % will take you to the next level of efficient marking.



### Highest flexibility

Due to the universal mounting rail holder and the laser direct marking technology, it is possible to very precisely mark terminal blocks and other mounting rail components – even with complex geometries. TS35 mounting rails can be marked from 100 to 1,200 mm in length, from 7.5 to 15 mm in height, and with a total weight of up to 15 kilograms.

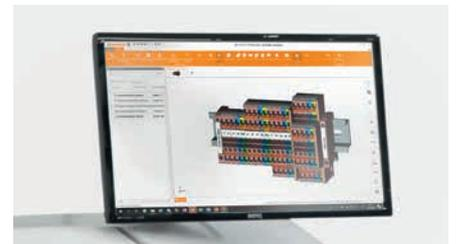

### Reliable quality

Due to the integration of the Weidmüller Configurator (WMC), planning data from eCAD programs can be used continuously. Error potentials are minimised because manual production steps and image processing in the machine are eliminated.

# Highest precision and quality

## Integrated image processing system for safe handling

The core of the Klippon® Automated RailLaser is an image processing system that is used to measure the terminal strips before the marking process. It determines the actual position of each marker, compares it with the theoretical position from the digital model and carries out the corresponding corrections fully automatically. This ensures a perfect marking result even in case of position deviations – e.g. because of thermal expansion of the components or inaccurate clamp position due to manual assembly.

The following illustrations show the advantage of labelling using the image processing system of the Klippon® Automated RailLaser: The system ensures first-class marking results in various applications and guarantees a high-quality appearance of the terminal strip in the finished control cabinet.

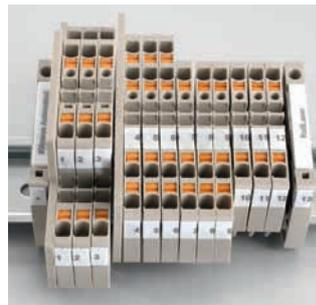
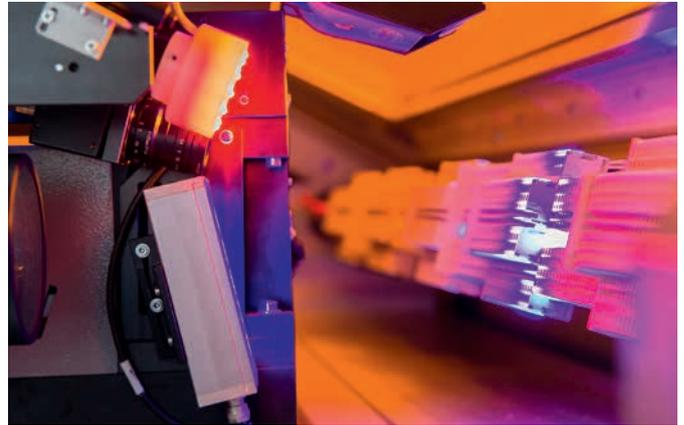

Marking result without image processing system



Marking result with image processing system

### Technical data

Supply voltage	400 V AC / 32 A
Dimensions (W × H × D)	2.260 x 1.350 x 1.200 mm
Installation area (W × D)	3.860 x 2.000 mm
Weight	1.200 kg
Interfaces	USB, Ethernet, Suction
Marker type	MultiCard on terminal block
Software	Weidmüller Configurator WMC
Laser wavelength	355 nm
Laser class according to EN60825-1	Class 1
Operation door	Opening/closing motorised
Mounting rail adapter	100 - 1.200 mm

### Ordering data

Type	Order No.
RAILLASER	2705010000

More technical details and further labelling systems can be found at [catalog.weidmueller.com](http://catalog.weidmueller.com)

# Discover the advantages of the PrintJet CONNECT

## Pioneering ideas and solutions for the optimal marking process



### Perfect printing results every time

The industrial print head of the PrintJet CONNECT is extremely robust and reliable. It delivers perfect printing results and is distinguished by its extremely long service life.

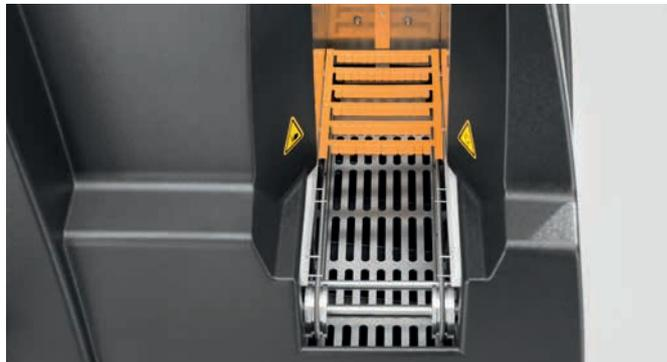

### Economical printing, even for small print runs

The PrintJet CONNECT is also capable of printing half MultiCards. In this way, even really small quantities or corrections can be produced economically and without unnecessary waste.



### Perfect print quality even on large markers

With the PrintJet CONNECT, graphics or full-surface printing can be produced in perfect print quality. The preheating of the print medium enables optimum ink flow control and therefore a uniform print result, even with large-area printing.



### Flexible printer positioning and easy access

The new design of the PrintJet CONNECT allows the printer to be flexibly positioned. With each possible layout, easy access for operation and maintenance is ensured thanks to the 7" display that can be rotated by 180°, the large magazines positioned at the front and the large service flap.





**Process different markers in one job**

The PrintJet CONNECT processes a wide variety of formats in one print job. This means that even with different markers there is no need to change the print media. The magazine and staker can hold up to 50 MultiCards for one job.

**Optimal support during operation**

The PrintJet CONNECT provides users with extensive, intuitively comprehensible support in the form of graphics, videos, web and QR codes, as well as links to information on the network. All the information can be easily selected and called up via the 7" touch display, which means that even employees who rarely use the printer can quickly learn how to operate it.



Low-maintenance design of the printer



Printing of more than 2 MultiCards per minute



Automatic calibration of the MultiCard



Dispenser magazine



# PrintJet CONNECT – the new state-of-the-art printer

## Technical details that will impress you

## C

### Perfectly centred prints without manual adjustment

The PrintJet CONNECT automatically adjusts itself to the size tolerances of the print media and therefore enables the print to be perfectly centred on each marker. Because MultiCard mats can minutely expand in case of highly fluctuating humidity, a sensor in the printer determines the exact size of the card and corrects the print values so that all the markers are printed evenly.

### Fast handling of large volumes

Printing of large volumes is made easier by the fast printing speed and the large dispenser magazine. The PrintJet CONNECT prints more than 2 MultiCards per minute and has a large dispenser magazine with automatic stacking function for up to 50 cards.

### Reliable even after extended storage

The print head of the PrintJet CONNECT can be quickly made ready for use again even after an extended storage period. Before placing it in storage, the ink cartridges are replaced with fluid cartridges that protect the print head from drying out.

### Standardise processes through high output

Thanks to its fast printing speed, the PrintJet CONNECT is also suitable for printing large quantities of markers. For example, up to 26,000 DEK 5/5 terminal markers, 10,000 TM-I wire markers or 5,000 ESG device markers can be printed per hour. The high throughput makes it possible to concentrate print jobs on one printer and therefore standardise processes.

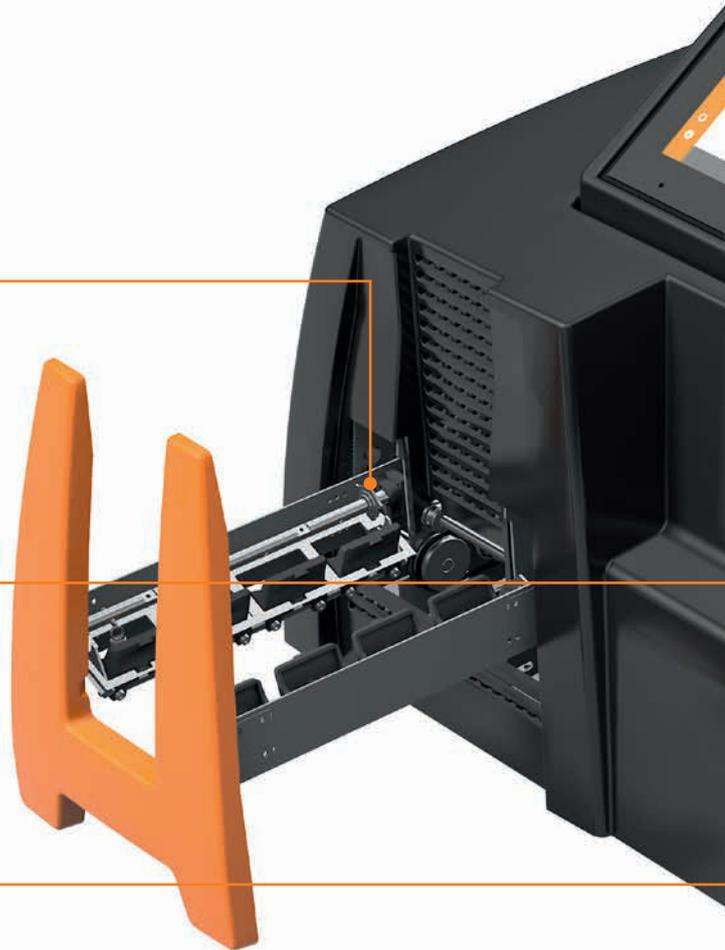

Up to  
**26,000**  
terminal markers  
per hour



C

**Benefit from optimal IT security**

The printer's integrated IPC works with the proven WIN 10 IoT operating system, which enables the installation of security updates that are provided by Weidmüller on a regular basis.

**Optimal service support**

The comprehensive documentation function of the PrintJet CONNECT creates informative log files, enabling service technicians to provide targeted support both on site and during remote maintenance. This way, your printer remains ready for use on site at any time, whenever it is needed.

**Optimal maintenance support**

The printer records and stores all operationally-relevant parameters such as power supply, ink consumption, service life, humidity and room temperature etc., and promptly warns users in the event of errors and abnormal deviations. Corresponding messages are shown on the display of the PrintJet CONNECT via the M-Print® PRO software or are sent by email.

# PrintJet CONNECT

## The networked high-performance printer for efficient and high-quality markings

### Your direct connection to the optimal marking process

The PrintJet CONNECT is the consistent further development of our tried-and-tested PrintJet series. Focusing on the modern needs of industry and panel building, it combines maximum process and cost efficiency with intelligent networking and complete data consistency. For example, you can use existing data directly in the marking process – for working more efficiently and with a minimal error rate. The PrintJet CONNECT is part of the Weidmüller marking system consisting of software, markers and printers. It has an extremely durable industrial print head and has been specially optimised for fast working speed and high throughput.

### Your advantages at a glance:

- Perfect printing results every time
- Fast handling of large volumes
- High level of automation thanks to magazine capacity of 50 MultiCards
- Durable and robust markers thanks to thermal fixing
- User-friendly operation thanks to intuitive touch display
- Flexible connection possibilities
- Simple function monitoring on the device



The new 7" touch colour display with a multitude of new functions ensures optimal operation.



Whether LAN, WLAN or USB: the PrintJet CONNECT offers a wide connectivity spectrum.

### Technical data

	Description
Intended use	Printing Weidmüller MultiCards and MetalliCards
Technology	Inkjet procedure with integrated thermal fixing unit
Feed	Automatic magazine for max. 30 MultiCards Individual feed for MetalliCards and MultiCards
Removal	Automatic dispenser magazine for up to 50 MultiCards
Fuses	10 ATH 240/120 V
Application site	Office conditions
Ambient temperature	10 °C – 35 °C 0 °F – 95 °F
Dimensions	Length including output rail: approx. 1.133 mm (44,60") Length not including output rail: approx. 930 mm (36,60") Width: 590 mm (23,20") Height: 454 mm (17,90")
Weight	63 kg with packaging 38 kg without packaging
Ink system	Colour system – black, cyan, magenta, yellow
Included in delivery	<ul style="list-style-type: none"> <li>• PrintJet CONNECT</li> <li>• Mains cable</li> <li>• LAN cable</li> <li>• USB cable</li> <li>• WIFI stick</li> <li>• one MultiCard DEK 5/5</li> <li>• DVD with M-Print® PRO software</li> <li>• Quick start guide</li> <li>• Operating manual</li> <li>• Ink set PJ CON INK SET</li> <li>• 2 PrintJet cleaner cloths</li> </ul>
The ink cartridges are not installed in the printer.	



High magazine capacity for loading and dispensing of up to 50 MultiCards.

**Ink-jet printer**

**PrintJet CONNECT**

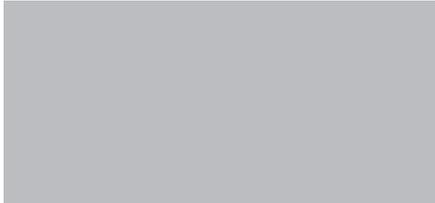
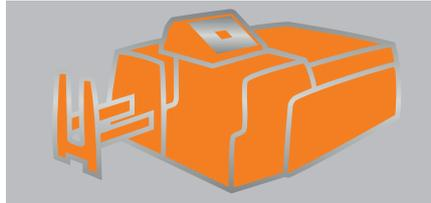

**Technical data**

EAN	4064675016922
Depth	930 mm
Width	590 mm
Height	454 mm
Net weight	38 kg
Printing method	Ink jet technology
Printer driver / Operating system	Windows 7, Windows 8, Windows 8.1, Windows 10
Printing speed	Depends on printing quality
Print quality	300 dpi, 600 dpi, 1200 dpi
Marker type	MultiCard, MetalliCard
Interface	USB, LAN, Wi-Fi
Fueling system	Ink cartridge, CMYK
Voltage supply	230 V AC / 16 A, 115 V AC / 20 A
Software	M-Print® PRO
<b>Note</b>	

**Ordering data**

Type	Qty.	Order No.
PRINTJET CONNECT	1	2715590000
<b>Note</b>		

**Accessories**

PrintJet CONNECT		Type	Qty.	Order No.
	Software	M-PRINT PRO	1	1905490000
	Ink set	PJ CON INK SET	1	2715600000
	Cyan ink	PJ CON INK C	1	2715610000
	Magenta ink	PJ CON INK M	1	2715620000
	Yellow ink	PJ CON INK Y	1	2715630000
	Black ink	PJ CON INK K	1	2715640000
	Fluid set	PJ CON FLUID SET	1	2715650000
	Ink collecting tray	PJ CON WASTE PAD	1	2715660000
	Textile cover	PJ CON TEXTILE COVER	1	2715670000
	WiFi Stick	PJ CON WIFI STICK	1	2715680000
PrintJet ADVANCED		Type	Qty.	Order No.
	Ink collecting tray	PJ ADV TNAW	1	1338710000
	Cyan ink	PJ ADV TNTK INK C	1	1338680000
	Magenta ink	PJ ADV TNTK INK M	1	1338670000
	Yellow ink	PJ ADV TNTK INK Y	1	1338650000
	Black ink	PJ ADV TNTK INK K	1	1338690000
	Ink set	PJ ADV TNTK INK SET	1	1338720000
<b>Note</b>				

# MCP Plus 2 Plotter

## Ideal for small quantities

### All-rounder with optimised use of space

The MCP Plus 2 is a flexible A3 plotter with labelling options for different applications. Three easily fitted receiver plates cover more than 250 types of MultiCards and label sheets. This means that you can simply and accurately print on remaining sheets, with simultaneous printing of up to 5 MultiCards. By using the appropriate mounting plate, you determine if you want to create small or large numbers of markers or if you wish to print labels. A pen repository takes the order and ensures that the plotter pens are always available.



### Your advantages from the MCP Plus 2 Plotter

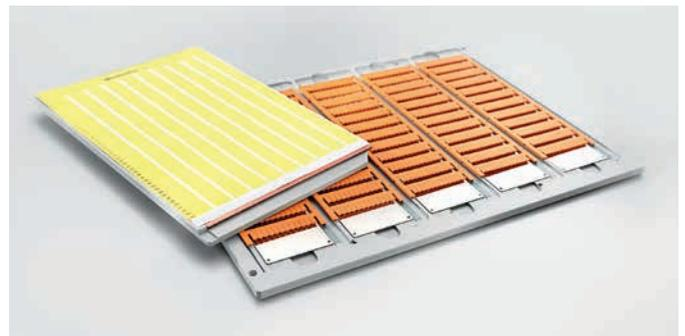

One printing system for various applications: the MCP Plus 2 prints over 250 types of MultiCards and labels.

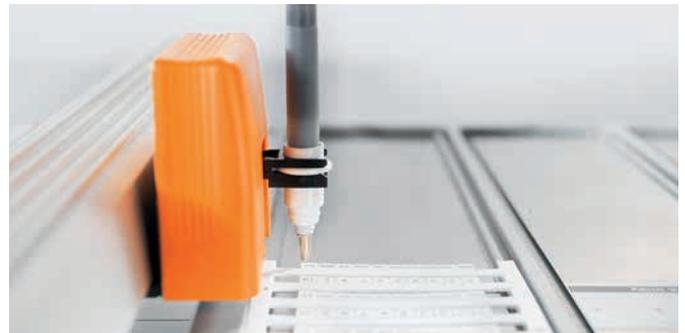

The mounting plate can be divided in an economical way: ideal for remaining stocks, part printing and low marking requirements.



If you use an MCP plotter, even small quantities can be printed.

### Technical data

	Description
Intended use	Printing Weidmüller MultiCards and DIN A4 labels
Technology	Flat bed plotter
Feed	Manuall mounting
Application site	Office conditions
Ambient temperature	10 °C to 35 °C
Included in delivery	<ul style="list-style-type: none"> <li>• Plotter MCP Plus 2</li> <li>• MultiCard mounting plate MCP AP PLUS</li> <li>• 5 Inlays MCP EP</li> <li>• Mains cable, Power supply (100-240 V AC / 5060 Hz), Euro plug</li> <li>• US plug and UK plug</li> <li>• Plotter pen 0.25 P-Ink</li> <li>• USB cable</li> <li>• Operating manual</li> <li>• DVD with M-Print® PRO software</li> </ul>

Plotter

MCP Plus 2

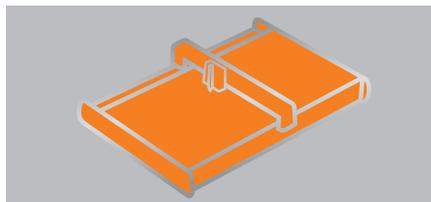
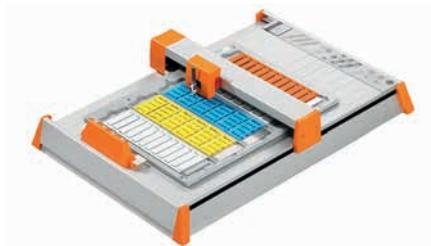

Technical data

EAN	4050118465389
Depth	155 mm
Width	480 mm
Height	690 mm
Net weight	14008 GRM
Printing method	Plotter printing with india ink
Printer driver / Operating system	Windows 7, Windows 8, Windows 8.1, Windows 10
Printing speed	max. 40 cm/s
Marker type	Multicard, Labels
Interface	USB
Voltage supply	100...240 V AC
Software	M-Print® PRO
Note	

EAN	4050118465389
Depth	155 mm
Width	480 mm
Height	690 mm
Net weight	14008 GRM
Printing method	Plotter printing with india ink
Printer driver / Operating system	Windows 7, Windows 8, Windows 8.1, Windows 10
Printing speed	max. 40 cm/s
Marker type	Multicard, Labels
Interface	USB
Voltage supply	100...240 V AC
Software	M-Print® PRO
Note	

Ordering data

Note	
------	--

Type	Qty.	Order No.
MCP PLUS 2	1	2438510000

Accessories

Mounting plates	
Plotter pen / adapter	
Reusable pens	
Disposable pens	
STI pen	
STI pen adapter	
Ink / cleaner	
INK 2000 ink	
P-Ink ink	
INK 2000 cleaner	
P-Ink cleaner	
Dust cover	
Note	

Type	Qty.	Order No.
MCP AP PLUS	1	1924360000
MCP AP SF4-6	1	1924310000
MCP AP LABELS	1	1924370000
MCP EP SFC 3	1	1058090000
PLOTTERPEN 0,18	1	1768570000
PLOTTERPEN 0,25	1	1768540000
PLOTTERPEN 0,35	1	1768550000
PLOTTERPEN 0,5	1	1768560000
PLOTTERPEN 0,7	1	1011440000
PLOTTER PEN 0.25 P-INK	1	1920640000
PLOTTER PEN 0.35 P-INK	1	1920650000
PLOTTER PEN 0.50 P-INK	1	1005710000
PLOTTER PEN 0.70 P-INK	1	1011450000
STI WATERPROOF SCHWARZ	10	0508401694
ADAPTER ALU STI-S	1	1762440000
TINTE 2000 25ML	1	1772120000
P-INK 2.0	1	1924340000
REINIGER 2000 25ML	1	1772130000
P-CLEANER	1	1924330000
MCP PLUS 2 COVER	1	2493070000

# MCP Basic 2 Plotter

## Flexible on-site marking

### Small size and readily on hand

The MCP Basic 2 is used when you need to print markers anywhere on-site in small quantities. The plotter is compact in size and can quickly be up and running wherever you are. Thanks to its low weight, it can be easily up and running everywhere quickly.

With three optionally usable mounting plates, the MCP Basic 2 covers over 250 types of MultiCards and labels. Particularly useful is the option to accept individual segments which makes it the perfect device for marking small quantities and reduces loss from unused signs.

### Your advantages from the MCP Basic 2 Plotter



Flexible for different applications: the MCP Basic 2 prints MultiCards and labels.



Single labels, sub-segments or remaining quantities: the MCP Basic 2 allows you to use the materials in an economical and targeted way.

### Technical data

	Description
Intended use	Printing Weidmüller MultiCards and DIN A4 labels
Technology	Flat bed plotter
Feed	Manuall mounting
Application site	Office conditions
Ambient temperature	10 °C to 35 °C
Included in delivery	<ul style="list-style-type: none"> <li>• Plotter MCP Basic 2</li> <li>• MultiCard mounting plate MCP AP BASIC</li> <li>• 3 Inlays MCP EP</li> <li>• Mains cable, Power supply (100-240 V AC / 5060 Hz), Euro plug</li> <li>• US plug and UK plug</li> <li>• Plotter pen 0.25 P-Ink</li> <li>• USB cable</li> <li>• Operating manual</li> <li>• DVD with M-Print® PRO software</li> </ul>



## Plotter

## MCP Basic 2

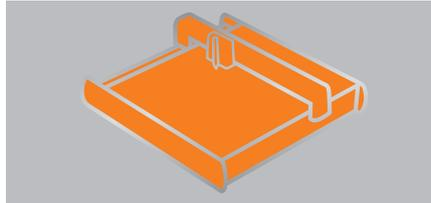
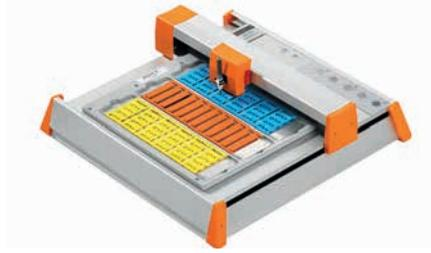

## Technical data

EAN	4050118465396
Depth	155 mm
Width	480 mm
Height	470 mm
Net weight	9620 GRM
Printing method	Plotter printing with india ink
Printer driver / Operating system	Windows 7, Windows 8, Windows 8.1, Windows 10
Printing speed	max. 40 cm/s
Marker type	Multicard, Labels
Interface	USB
Voltage supply	100...240 V AC
Software	M-Print® PRO
<b>Note</b>	

## Ordering data

Type	Qty.	Order No.
MCP BASIC 2	1	2438520000
<b>Note</b>		

## Accessories

Type	Qty.	Order No.
MCP AP BASIC	1	1139880000
MCP AP LABELS	1	1924370000
MCP AP SF4-6	1	1924310000
MCP EP SFC 3	1	1058090000
MCP EP	1	1935130000
<b>Mounting plates</b>		
<b>Plotter pen / adapter</b>		
P-Ink cleaner		
Reusable pens		
PLOTTERPEN 0,18	1	1768570000
PLOTTERPEN 0,25	1	1768540000
PLOTTERPEN 0,35	1	1768550000
PLOTTERPEN 0,5	1	1768560000
PLOTTERPEN 0,7	1	1011440000
Disposable pens		
PLOTTER PEN 0.25 P-INK	1	1920640000
PLOTTER PEN 0.35 P-INK	1	1920650000
PLOTTER PEN 0.50 P-INK	1	1005710000
PLOTTER PEN 0.70 P-INK	1	1011450000
STI pen adapter	1	1762440000
STI pen		
STI WATERPROOF SCHWARZ	10	0508401694
<b>Ink / cleaner</b>		
INK 2000 ink	1	1772120000
P-INK ink	1	1924340000
INK 2000 cleaner	1	1772130000
P-INK cleaner	1	1924330000
<b>Dust cover</b>		
MCP BASIC 2 COVER	1	2493080000
<b>Note</b>		

## Reasons to choose MultiCard

### The perfect marking solution for every application

**The complete, user-friendly marker range to meet all your needs.**

From the planning phase of a marking project to final assembly, the MultiCard range has over 270 markers to meet all application levels and identification processes. Thanks to the excellent compatibility of the system components, you can always find the right solution for your connector, conductor, cable or device markings, even when it comes to more complex electrical cabinet systems. When a MultiCard marker is designed, the user is the focal point. All the mounting options and processes are therefore included in the design of the system elements. You can also keep an overview and act in a timely fashion due to the information on the project description areas and using the storage option in the circuit diagram folder. The exceptionally smudge-resistant and intense colour printing means that you can achieve maximum efficiency in diverse areas of application.



Using PrintJet CONNECT, you can print your markers with non-fading four-colour print – customised with graphics, company logos, warning notices and much more.

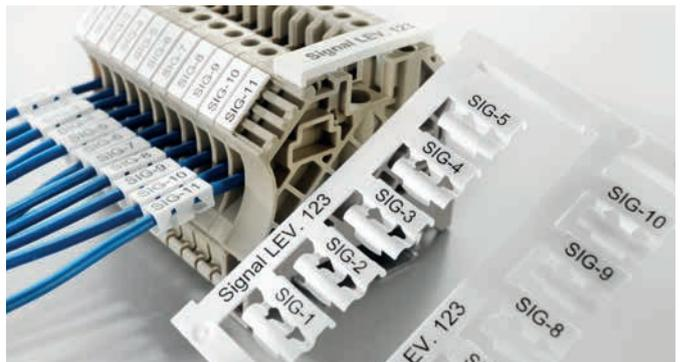

The project marker surface is the place for assembly relevant information, which enables you to quickly identify the correct installation location.



MultiCard markers are halogen-free and resistant to many chemicals. Their high-quality design means that they are suitable for the most demanding applications areas, such as transportation and building technology.



# Terminal markers

Our range of terminal markers enables you to accomplish virtually any labelling task, on any conductor connector. Whether this involves multi-digit labelling, ready-to-use markers with standard print or customised labelling, white or colour markers or group designations at the clamping points – our comprehensive product portfolio is the easy, quick and clear answer to every marking task.

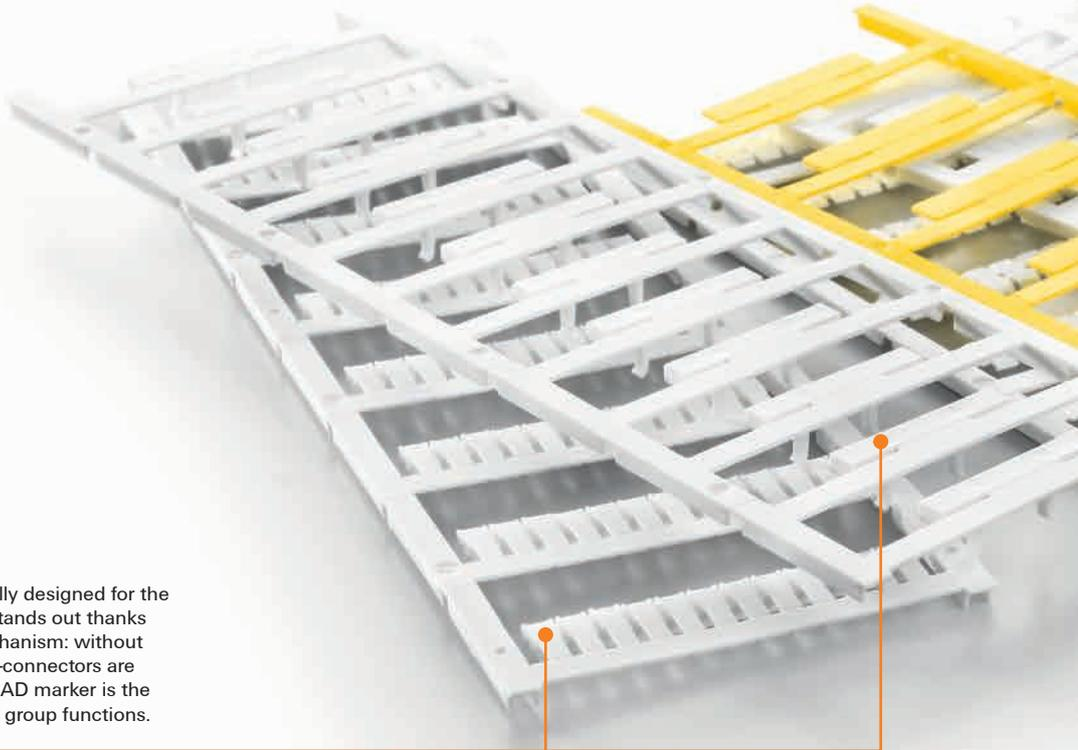

**ZS + WAD**

The ZS markers were specially designed for the Z-series, their functionality stands out thanks to a time-saving folding mechanism: without removing the markers, cross-connectors are still easily accessible. The WAD marker is the preferred choice for marking group functions.



**Tag carrier**

Available to you for every solution, is a suitable tag carrier that is tailored according to your needs and matched to the MultiCard product line.

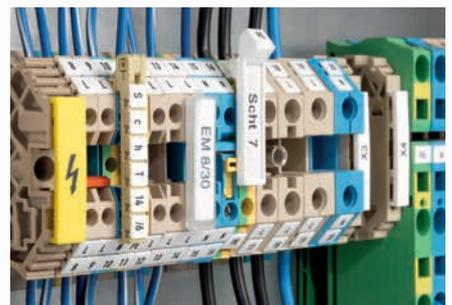

**ELS**

Optimally designed for use in WKM cable markers or SchT 5-type tag carriers, the ELS tags meet the highest requirements where prominent identification of cables and terminal strips is needed.

**Dekafix + WS**

Conductor and plug-in connectors, as well as electronic assemblies, can be identified quickly and easily with the Dekafix and WS markers.

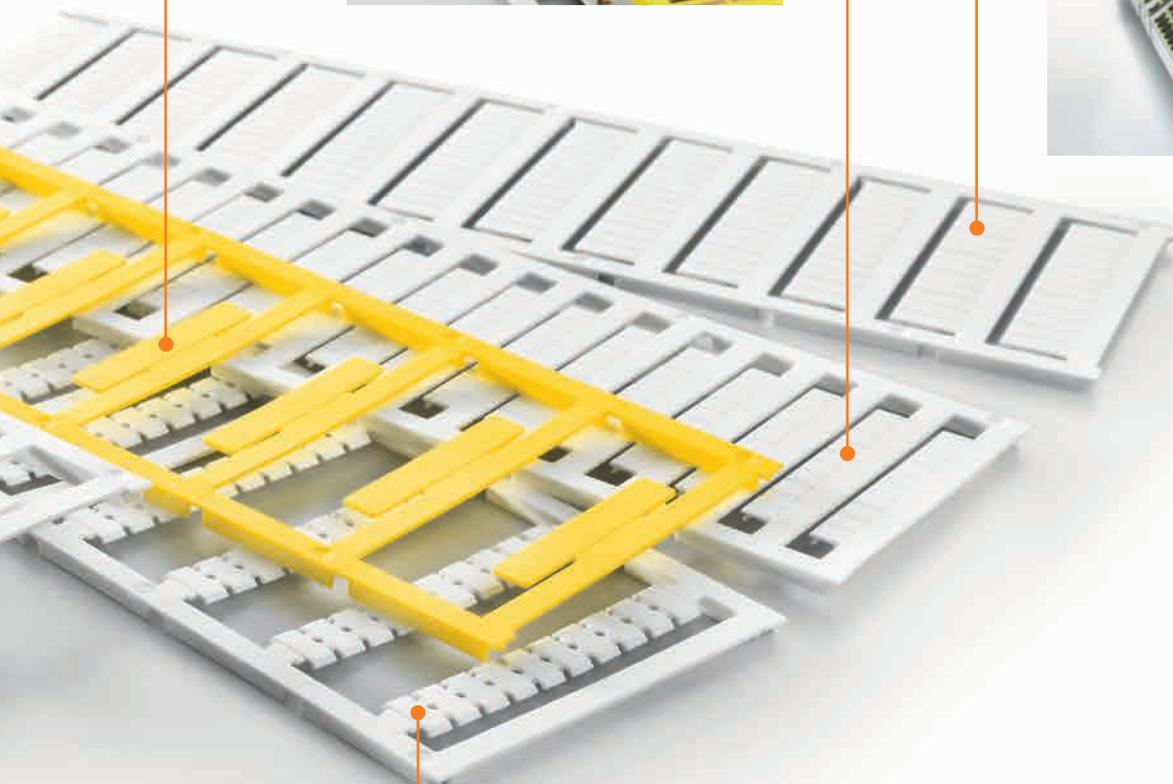
**MultiFit**

For manufacturer-independent marking of components, we have developed the adaptable MultiFit marker range. The MF 5/12 MC connector marker, for example, is suitable for identifying the flat channel of the 12 mm wide modular terminals from Phoenix Contact.

**PrintJet CONNECT**

The PrintJet CONNECT is suitable for all plastic and metal markers from the MultiCard and MetalliCard families and achieves extremely durable, excellent printing results on all media.



# Terminal markers for the universal range for Klippon® Connect

The tables on the following pages show which markers fit the various terminal series. The terminal pitch governs the selection of a marker. For example, a WDU 2.5 terminal has a pitch of 5 mm, the WS 12/5 marker is 12 mm long and suitable for a 5 mm pitch.

## C

Whole blocks of terminals can be marked as a strip. When a terminal with a larger pitch has to be marked (e.g. WDU 16), a smaller marker (e.g. WS 12/5) can be clipped onto it. Most of the markers are compatible with each other.

The two traditional marker series, DEK and WS, are available as ready-to-use markers. Users can print these for themselves using our Multicards.

MultiCards can be printed on, using the innovative PrintJet CONNECT, MCP Plus 2 or MCP Basic 2 printing systems in conjunction with our M-Print® PRO software.

To see a small selection of our markers, order a bag of samples, order No. **1646670000**.

Owing to the sheer number of possible applications and environmental influences such as moisture, radiation, gases or heat/cold to which the products can be exposed, Weidmüller accepts no liability for the suitability of products in all customer applications. Suitability tests for specific applications must therefore be carried out by the customer. However, Weidmüller will be happy to provide help and advice upon request. Due to the different identification system available on the market, we wish to point out that Weidmüller does not guarantee industrial identification products if the Weidmüller components (markers – transparent sleeves – ink/toner/colour ink ribbons – printing systems) are combined with third-party products, unless Weidmüller has explicitly agreed for the purpose of an individual application.

**A series**



**W series**

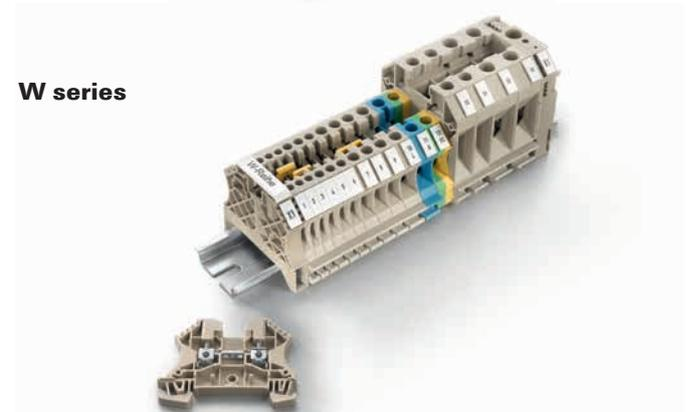

**Z series**



**P series**

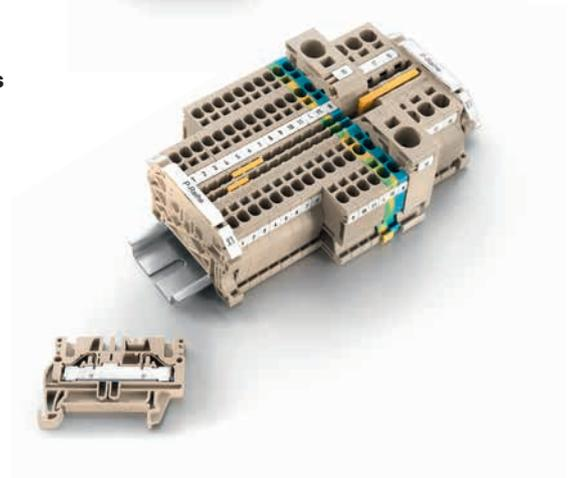

Designation	Terminal width	DEK	WS	ZS	DEK MM	WS MM	SchT 7	WAD 5	WAD 8	WAD 12	WAD 27	ZGB 15 / ZGB 30	BZT 1	BZT 2	EM 8/30	Other
A2C 1.5...(PE)	3.5	5/3.5	10/3.5		5/3.5	8/3.5	-	-	-	-	-	-	-	-	-	-
A3C 1.5...(PE)	3.5	5/3.5	10/3.5		5/3.5	8/3.5	-	-	-	-	-	-	-	-	-	-
A4C 1.5...(PE)	3.5	5/3.5	10/3.5		5/3.5	8/3.5	-	-	-	-	-	-	-	-	-	-
A2C 2.5...(PE)	5.1	5/5	10/5		5/5	8/5	x	-	-	-	-	x	x	x	-	-
A3C 2.5...(PE)	5.1	5/5	10/5		5/5	8/5	x	-	-	-	-	x	x	x	-	-
A4C 2.5...(PE)	5.1	5/5	10/5		5/5	8/5	x	-	-	-	-	x	x	x	-	-
A2C 4...(PE)	6.1	5/6	10/6		5/6	8/6	x	-	-	-	-	x	x	x	-	-
A3C 4...(PE)	6.1	5/6	10/6		5/6	8/6	x	-	-	-	-	x	x	x	-	-
A4C 4...(PE)	6.1	5/6	10/6		5/6	8/6	x	-	-	-	-	x	x	x	-	-
A2C 6...(PE)	8.1	5/8	10/8		-A 5/8	-A8/8	x	-	-	-	-	x	x	x	-	-
A3C 6...(PE)	8.1	5/8	10/8		-A 5/8	-A8/8	x	-	-	-	-	x	x	x	-	-
A2C 10...(PE)	10	5/8	10/8		-A 5/8	-A8/10	x	-	-	-	-	x	x	x	-	-
A3C 10...(PE)	10	5/8	10/8		-A 5/8	-A8/10	x	-	-	-	-	x	x	x	-	-
A2C 16...(PE)	12	5/8	10/8		-A 5/8	-A8/12	x	-	-	-	-	x	x	x	-	-
A3C 16...(PE)	12	5/8	10/8		-A 5/8	-A8/12	x	-	-	-	-	x	x	x	-	-
A2C 35...(PE)	16	5/8	10/8		-A 5/8	-A8/16	x	-	-	-	-	x	x	x	-	-
A2C 50/70...(PE)	20	5/8	10/8		-A 5/8	-A8/16	x	-	-	-	-	x	x	x	-	-
A2C 95/120...(PE)	25	5/8	10/8		-A 5/8	-A8/16	x	-	-	-	-	x	x	x	-	-
ALD 6	9	5/5	10/5		5/5	-A8/8	x	-	-	-	-	x	x	x	-	-
ALD 16	12	5/8	10/8		-A 5/8	-A8/12	x	-	-	-	-	x	x	x	-	-
A2T 1.5...(PE)	3.5	5/3.5	10/3.5		5/3.5	8/3.5	-	-	-	-	-	-	-	-	-	SNAPMARK 1.5
A2T 2.5...(PE)	5.1	5/5	10/5		5/5	8/5	x	-	-	-	-	x	x	x	-	SNAPMARK I
A3T 2.5...(PE)	5.1	5/5	10/5		5/5	8/5	x	-	-	-	-	x	x	x	-	SNAPMARK I
A2T 4...(PE)	6.1	5/6	10/6		5/6	8/6	x	-	-	-	-	x	x	x	-	-
AFS 2.5...	5.1	5/5	10/5		5/5	8/5	x	-	-	-	-	x	x	x	-	-
AFS 4...	6.1	5/6	10/6		5/6	8/6	x	-	-	-	-	x	x	x	-	-
ADT 2.5 2C...(PE)	5.1	5/5	10/5		5/5	8/5	x	-	-	-	-	x	x	x	-	-
ADT 2.5 3C...	5.1	5/5	10/5		5/5	8/5	x	-	-	-	-	x	x	x	-	-
ADT 2.5 4C...	5.1	5/5	10/5		5/5	8/5	x	-	-	-	-	x	x	x	-	-
AAP11 6...	8.1	5/8	-		-A 5/8	-A8/8	x	-	-	-	-	x	x	x	-	-
AAP11 1.5...	3.5	5/3.5	10/3.5		5/3.5	8/3.5	-	-	-	-	-	-	-	-	-	-
AAP12 10...	10		7.8/9.2		-A 5/8	-A8/10	x	-	-	-	-	x	x	x	-	-
AAP12 2.5...	5.1	5/5	-		5/5	8/5	x	-	-	-	-	x	x	x	-	-
AAP13 6...	8.1	5/8	-		-A 5/8	-A8/8	x	-	-	-	-	x	x	x	-	-
AAP13 1.5...	3.5	5/3.5	10/3.5		5/3.5	8/3.5	x	-	-	-	-	x	x	x	-	-
AAP14 10...	10		7.8/9.2		-A 5/8	-A8/10	x	-	-	-	-	x	x	x	-	-
AAP14 2.5...	5.1	5/5	-		5/5	8/5	x	-	-	-	-	x	x	x	-	-
AID21 1.5 SI...(PE)	3.5	5/3.5	10/3.5		5/3.5	8/3.5	-	-	-	-	-	-	-	-	-	-
AID22 1.5 SI-PE	3.5	5/3.5	10/3.5		5/3.5	8/3.5	-	-	-	-	-	-	-	-	-	-
AID23 1.5 SI	3.5	5/3.5	10/3.5		5/3.5	8/3.5	-	-	-	-	-	-	-	-	-	-
APGTB 1.5 FT 2C/1	3.5	5/3.5	10/3.5		5/3.5	8/3.5	-	-	-	-	-	-	-	-	-	-
APGTB 1.5 PE 2C/1	3.5	5/3.5	10/3.5		5/3.5	8/3.5	-	-	-	-	-	-	-	-	-	-
APGTB 1.5 2T 4C/2	3.5	5/3.5	10/3.5		5/3.5	8/3.5	-	-	-	-	-	-	-	-	-	SNAPMARK 1.5
APGTB 1.5 2T FT-PE 4C/2	3.5	5/3.5	10/3.5		5/3.5	8/3.5	-	-	-	-	-	-	-	-	-	SNAPMARK 1.5
APGTB 1.5 2T PE 4C/2	3.5	5/3.5	10/3.5		5/3.5	8/3.5	-	-	-	-	-	-	-	-	-	SNAPMARK 1.5
APGTB 1.5 2T VL 4C/2	3.5	5/3.5	10/3.5		5/3.5	8/3.5	-	-	-	-	-	-	-	-	-	SNAPMARK 1.5
APGTB 2.5 FT 2C/1	5.1	5/5	10/5		5/5	8/5	x	-	-	-	-	x	x	x	-	-
APGTB 2.5 PE 2C/1	5.1	5/5	10/5		5/5	8/5	x	-	-	-	-	x	x	x	-	-
APGTB 2.5 2T 4C/2	5.1	5/5	10/5		5/5	8/5	x	-	-	-	-	x	x	x	-	SNAPMARK I
APGTB 2.5 2T FT-PE 4C/2	5.1	5/5	10/5		5/5	8/5	x	-	-	-	-	x	x	x	-	SNAPMARK I
APGTB 2.5 2T PE 4C/2	5.1	5/5	10/5		5/5	8/5	x	-	-	-	-	x	x	x	-	SNAPMARK I
APGTB 2.5 2T VL 4C/2	5.1	5/5	10/5		5/5	8/5	x	-	-	-	-	x	x	x	-	SNAPMARK I
APGTB 4 FT 2C/1	6.1	5/6	10/6		5/6	8/6	x	-	-	-	-	x	x	x	-	-
APGTB 4 PE 2C/1	6.1	5/6	10/6		5/6	8/6	x	-	-	-	-	x	x	x	-	-
APGTB 4 2T 4C/2	6.1	5/6	10/6		5/6	8/6	x	-	-	-	-	x	x	x	-	-
APGTB 4 2T FT-PE 4C/2	6.1	5/6	10/6		5/6	8/6	x	-	-	-	-	x	x	x	-	-
APGTB 4 2T PE 4C/2	6.1	5/6	10/6		5/6	8/6	x	-	-	-	-	x	x	x	-	-
APGTB 4 2T VL 4C/2	6.1	5/6	10/6		5/6	8/6	x	-	-	-	-	x	x	x	-	-
ADK 1	6	6	-		-	-	-	-	-	-	-	-	-	-	-	-
AKE 2.5/AKZ 2.5...	5	5/5	-		5/5	-	-	-	-	-	-	-	-	-	-	-
AKE 2.5	5.1	5/5	-		5/5	-	-	-	-	-	-	-	-	-	-	-
AKE 4	7	5/6.5	-		5/6.5	-	-	-	-	-	-	-	-	-	-	-
AKZ 1.5...	5	5/5	-		5/5	-	-	-	-	-	-	-	-	-	-	-
AKZ 1.5-2.5	5.1	5/5	-		5/5	-	-	-	-	-	-	-	-	-	-	-
AKZ 4	6.1	5/6	-		5/6	-	-	-	-	-	-	-	-	-	-	-
AKZ 4.../AKB 4...	6	5/6	8/5		5/6	8/5	-	-	-	-	-	-	-	-	-	-
AL 1	6.5	6.5	-		-	-	-	-	-	-	-	-	-	-	-	-
ASK 1	8	5/8	-		5/8	-	x	-	-	-	-	-	-	-	-	-
AST 1-4/35	6.2	5/6	-		5/6	-	-	-	-	-	-	-	-	-	-	-
AST 5/35	6.5	5/6	-		5/6	-	-	-	-	-	-	-	-	-	-	-

1) = WS 10/6 Middle; 2) = WS 10/5 Middle; 3) = SnapMark

**Selection table Terminal markers**

Designation	Terminal width	DEK	WS	ZS	DEK MM	WS MM	SchT 7	WAD 5	WAD 8	WAD 12	WAD 27	ZGB 15 / ZGB 30	BZT 1	BZT 2	EM 8/30	Other
BZT ZVL 1.5	5.08	5/5	12/5	-	5/5	12/5	-	-	-	-	-	-	-	-	-	-
DK 4...	6	5/6	-	-	5/6	-	-	-	-	-	-	-	-	-	-	-
DKT 4...	6	5/6	-	-	5/6	-	-	-	-	-	-	-	-	-	-	-
DLA 2.5...	6	5/6	8/5	-	5/6	8/5	x	-	-	-	-	-	-	-	-	-
DLD 2.5...	6	5/6	8/6	-	5/6	8/6	x	-	-	-	-	-	-	-	-	-
DLI 2.5	6	5/6	8/5	-	5/6	8/5	x	-	-	-	-	-	-	-	-	-
EK 10	10	5/5	-	-	5/5	-	-	-	-	-	-	-	-	-	-	-
EK 16	12	5/5	-	-	5/5	-	-	-	-	-	-	-	-	-	-	-
EK 2.5...	6	5/6	-	-	5/6	-	-	-	-	-	-	-	-	-	-	-
EK 35...	16	5/5	-	-	5/5	-	-	-	-	-	-	-	-	-	-	-
EK 4...	6.5	5/6.5	-	-	5/6.5	-	-	-	-	-	-	-	-	-	-	-
EK 6/35	8	5/8	-	-	5/8	-	-	-	-	-	-	-	-	-	-	-
EW 15	9.5	5/5	12/5	-	5/5	12/5	x	-	-	-	-	-	-	-	-	-
EW 15/2	8	5/5	-	-	5/5	-	-	-	-	-	-	-	-	-	-	-
EW 35	8.5	5/5	8/5	-	5/5	8/5	-	-	-	-	-	-	-	-	-	-
EWK	8.5	5/5	8/5	-	5/5	8/5	-	-	-	-	-	-	-	-	-	-
EWK 1	8.5	5/5	8/5	-	5/5	8/5	-	-	-	-	-	-	-	-	-	-
EWK 2	8.5	5/5	8/5	-	5/5	8/5	-	-	-	-	-	-	-	-	-	-
KDKS 1...	8	5/8	-	-	5/8	-	-	-	-	-	-	-	-	-	-	-
KMVF...	6	5/5	-	-	5/5	-	-	-	-	-	-	-	-	-	-	-
KSKM...	13	5/5	-	-	5/5	-	-	-	-	-	-	-	-	-	-	-
KST...	24-34	5	-	-	-	-	-	-	-	-	-	-	-	-	-	-
MAK 2.5/VLI 1.5...	6	5/6	8/5	-	5/6	8/5	x	-	-	-	-	x	-	-	-	-
NT...	12	5/6	-	-	5/6	-	-	-	-	-	-	-	-	-	-	-
PDK 2.5/4	5	5/5	12/5	-	5/5	12/5	-	-	-	-	-	-	-	-	-	-
PDL 4...	5	5/5	12/5	-	5/5	12/5	-	-	-	-	-	-	-	-	-	-
PDL 6...	8.1	5/8	10/8	-	5/8	8/8	-	-	-	-	-	-	-	-	-	-
PDU 16	12	-	10/12	-	-	-	-	-	-	-	-	-	-	-	-	-
PDU 2.5/4...	5	5/5	12/5	-	5/5	12/5	-	-	-	-	-	-	-	-	-	-
PDU 6/10...	8	5/8	10/8	-	5/8	8/8	-	-	-	-	-	-	-	-	-	-
PEI 16	12	-	10/12	-	-	-	-	-	-	-	-	-	-	-	-	-
PMAK 4...	5.1	5/5	-	-	5/5	8/5	-	-	-	-	-	-	-	-	-	-
PNT 16	12	-	10/12	-	-	-	-	-	-	-	-	-	-	-	-	-
PNT 2.5/4	5	5/5	12/5	-	5/5	12/5	-	-	-	-	-	-	-	-	-	-
PNT 6/10	8	5/8	10/8	-	5/8	8/8	-	-	-	-	-	-	-	-	-	-
PPE 16	12	-	10/12	-	-	-	-	-	-	-	-	-	-	-	-	-
PPE 2.5/4	5	5/5	12/5	-	5/5	12/5	-	-	-	-	-	-	-	-	-	-
PPE 6/10	8	5/8	10/8	-	5/8	8/8	-	-	-	-	-	-	-	-	-	-
PSI 6/10	12.2	-	10/8	-	-	-	-	-	-	-	-	-	-	-	-	-
PTR 2.5/4...	5.1	5/5	10/5	-	5/5	8/8	-	-	-	-	-	-	-	-	-	-
PPV 4...	9.2	-	7.8/9.2	-	-	-	-	-	-	-	-	-	-	-	-	-
PPV 8...	9.2	-	7.8/9.2	-	-	-	-	-	-	-	-	-	-	-	-	-
PRV 4...	9.2	-	7.8/9.2	-	-	-	-	-	-	-	-	-	-	-	-	-
PRV 8...	9.2	-	7.8/9.2	-	-	-	-	-	-	-	-	-	-	-	-	-
PRV 16...	9.2	-	7.8/9.2	-	-	-	-	-	-	-	-	-	-	-	-	-
RSF 1-3...	8	5/5	-	-	5/5	-	-	-	-	-	-	-	-	-	-	-
SAK 10...	10	5/5	-	-	5/5	-	-	-	-	-	-	-	-	-	-	-
SAK 16...	12	5/5	-	-	5/5	-	-	-	-	-	-	-	-	-	-	-
SAK 2.5	6.1	5/6	-	-	5/6	-	x	-	-	-	-	-	-	-	-	-
SAK 2.5/35	5	5/5	-	-	5/5	-	x	-	-	-	-	-	-	-	-	-
SAK 35...	18	5/5	-	-	5/5	-	x	-	-	-	-	-	-	-	-	-
SAK 4...	6.5	5/6.5	-	-	5/6.5	-	x	-	-	-	-	-	-	-	-	-
SAK 6...	8	5/8	-	-	5/8	-	x	-	-	-	-	-	-	-	-	-
SAK 95/35	28	5/5	-	-	5/5	-	x	-	-	-	-	-	-	-	-	-
SAKA 10	12	5/5	-	-	5/5	-	x	-	-	-	-	-	-	-	-	-
SAKB 10	10	5/5	-	-	5/5	-	x	-	-	-	-	-	-	-	-	-
SAKC 10/35	12	5/6.5	-	-	5/6.5	-	x	-	-	-	-	-	-	-	-	-
SAKC 4/35	6.5	5/6.5	-	-	5/6.5	-	x	-	-	-	-	-	-	-	-	-
SAKD 2.5N	5	5/5	-	-	5/5	-	x	-	-	-	-	-	-	-	-	-
SAKG...	32-54	5/5	-	-	5/5	-	x	-	-	-	-	-	-	-	-	-
SAKH 35	18	5/6.5	-	-	5/6.5	-	-	-	-	-	-	-	-	-	-	-
SAKH 4-10	6.5-14	5/5	-	-	5/5	-	x	-	-	-	-	-	-	-	-	-
SAKK 10...	11.5	5/5	-	-	5/5	-	x	-	-	-	-	-	-	-	-	-
SAKK 4...	8	5/6.5	-	-	5/6.5	-	x	-	-	-	-	-	-	-	-	-
SAKR...	6.5	5/6.5	-	-	5/6.5	-	x	-	-	-	-	-	-	-	-	-
SAKS...	13-28	5/5	-	-	5/5	-	x	-	-	-	-	-	-	-	-	-
SAKT...	8	5/6.5	-	-	5/6.5	-	x	-	-	-	-	-	-	-	-	-
VWVGK 4...	10	5/5	12/6.5	-	5/5	-	-	-	-	-	-	-	-	-	-	-
VWVGK 6...	10	5/5	12/6.5	-	5/5	-	-	-	-	-	-	-	-	-	-	-
WDK 1.5/R 3.5...	3.5	5/3.5	-	-	5/3.5	-	-	-	-	-	-	-	-	-	-	-



Designation	Terminal width	DEK	WS	ZS	DEK MM	WS MM	SchT 7	WAD 5	WAD 8	WAD 12	WAD 27	ZGB 15/ ZGB 30	BZT 1	BZT 2	EM 8/30	Other
WDK 2.5 ...	5	5/5	8/5	-	5/5	8/5	-	-	-	-	-	x	-	-	-	-
WDK 2.5 800V	6	5/6	8/5	-	5/6	8/5	-	-	-	-	-	x	-	-	-	-
WDK 2.5/BLA R5.08	5.08	5/5	8/5	-	5/5	8/5	-	-	-	-	-	-	-	-	-	-
WDK 2.5/BLZ R5.08	5.08	5/5	8/5	-	5/5	8/5	-	-	-	-	-	-	-	-	-	-
WDK 2.5N...	5	5/5	8/5	-	5/5	8/5	-	-	-	-	-	-	-	-	-	-
WDK 4N...	5	5/5	8/5	-	5/5	8/5	-	-	-	-	-	-	-	-	-	-
WDL 2.5/...	6	5/6	8/5	-	5/6	8/5	-	-	-	-	-	x	-	-	-	-
WDT 1.5	6.5	5/6.5	8/5	-	5/6.5	8/5	-	-	-	-	-	-	-	-	-	-
WDTR 2.5...	6.2	5/6	8/5	-	5/6	8/5	-	-	-	-	-	-	-	-	-	-
WDU (WPE) 120/150	32	5/5	10/5	-	5/5	8/5	-	-	-	-	x	-	-	-	-	-
WDU (WPE) 35 N	16	5/5	12/5	-	5/5	12/5	x	-	-	-	-	x	-	-	-	-
WDU (WPE) 70/95	27	5/5	12/5	-	5/5	12/5	-	-	-	-	x	-	-	-	-	-
WDU (WPE) 70N	20.5	5/5	12/5	-	5/5	12/5	x	-	-	-	-	x	-	-	-	-
WDU 1.5 LD/BLA	5.08	5/5	12/5	-	5/5	12/5	x	-	-	-	-	x	-	-	-	-
WDU 1.5/BLA	5.08	5/5	12/5	-	5/5	12/5	x	-	-	-	-	x	-	-	-	-
WDU 1.5/BLZ R7.62	7.62	5/5	-	-	5/5	-	-	-	-	-	-	x	-	-	-	-
WDU 1.5/BLZ/5.08	5.08	5/5	12/5	-	5/5	12/5	x	-	-	-	-	x	-	-	-	-
WDU 1.5/BLZ/LD/5.08	5.08	5/5	12/5	-	5/5	12/5	x	-	-	-	-	x	-	-	-	-
WDU 1.5/R 3.5...	3.5	5/3.5	-	-	5/3.5	-	-	-	-	-	-	-	-	-	-	-
WDU 1.5/R/BLA	5.08	5/5	12/5	-	5/5	12/5	x	-	-	-	-	x	-	-	-	-
WDU 1.5/ZZ	5	5/5	12/5	-	5/5	12/5	x	-	-	-	-	x	-	-	-	-
WDU 10 SL	10	5/5	12/5	-	5/5	12/5	x	x	x	-	-	x	-	-	-	-
WDU 10...	10	5/5	12/5	-	5/5	12/5	x	x	x	-	-	x	-	-	-	-
WDU 16 (ZA)	12	5/5	12/5	-	5/5	12/5	x	-	-	x	-	x	-	-	-	-
WDU 16 N	12	5/5	12/5	-	5/5	12/5	x	-	-	-	-	x	-	-	-	-
WDU 2.5 F	5	5/5	12/5	-	5/5	12/5	-	-	-	-	-	-	-	-	-	-
WDU 2.5 FF	5	5/5	12/5	-	5/5	12/5	x	-	-	-	-	-	-	-	-	-
WDU 2.5 N (WDU 1.5)	5	5/5	12/5	-	5/5	12/5	x	-	-	-	-	x	-	-	-	-
WDU 2.5 TC...	5	5/5	12/5	-	5/5	12/5	x	-	-	-	-	x	-	-	-	-
WDU 2.5...	5	5/5	12/5	-	5/5	12/5	x	x	-	-	-	x	-	-	-	-
WDU 2.5/1.5/ZZ	5	5/5	12/5	-	5/5	12/5	x	-	-	-	-	x	-	-	-	-
WDU 2.5/BLZ R7.62	7.62	5/5	-	-	5/5	-	-	-	-	-	-	x	-	-	-	-
WDU 240...	36	5/5	12/5	-	5/5	12/5	-	-	-	-	-	-	-	-	-	-
WDU 35	16	5/5	12/5	-	5/5	12/5	x	-	-	x	-	x	-	-	-	-
WDU 4 ...	6	5/6	12/6	-	5/6	12/6	x	x	-	-	-	x	-	-	-	-
WDU 4N ...	6	5/6	12/6	-	5/6	12/6	x	-	-	-	-	x	-	-	-	-
WDU 50N	18.5	5/5	12/5	-	5/5	12/5	-	-	-	-	-	-	-	-	-	-
WDU 6 ...	8	5/8	12/8	-	5/8	12/8	x	x	x	-	-	x	-	-	-	-
WDU 95N	27	5/8	15/5	-	5/8	12/5	-	-	-	-	-	-	-	-	-	-
WDUL 4	6	5/6	12/6	-	5/6	12/6	x	x	-	-	-	x	-	-	-	-
WEW 32/1	12.2	5/5	12/5	-	5/5	12/5	x	-	-	-	x	x	-	-	-	-
WEW 35/1	12.2	5/5	12/5	-	5/5	12/5	x	-	-	-	-	-	-	-	-	-
WEW 35/2	8	5/8	12/5	-	5/8	12/5	x	x	x	-	-	-	-	-	x	-
WF 10...	35.6	5/6	15/5	-	5/6	12/5	-	-	-	-	-	-	-	-	-	-
WF 12...	35.6	5/6	15/5	-	5/6	12/5	-	-	-	-	-	-	-	-	-	-
WF 5...	13	5/6	15/5	-	5/6	12/5	-	-	-	-	-	-	-	-	-	-
WF 6...	19.6	5/6	15/5	-	5/6	12/5	-	-	-	-	-	-	-	-	-	-
WF 8...	24.6	5/6	15/5	-	5/6	12/5	-	-	-	-	-	-	-	-	-	-
WFF 120...	42	5/5	12/6.5	-	5/5	-	-	-	-	-	-	-	-	-	-	-
WFF 185...	55	5/5	12/6.5	-	5/5	-	-	-	-	-	-	-	-	-	-	-
WFF 300...	55	5/5	12/6.5	-	5/5	-	-	-	-	-	-	-	-	-	-	-
WFF 35...	27	5/5	12/5	-	5/5	12/5	-	-	-	-	-	-	-	-	-	-
WFF 70...	32	5/5	12/6.5	-	5/5	-	-	-	-	-	-	-	-	-	-	-
WGK 10.../WGKV 10...	10.1	5/5	12/6.5	-	5/5	-	-	-	-	-	-	-	-	-	-	-
WGK 16...	12.1	5/5	12/6.5	-	5/5	-	-	-	-	-	-	-	-	-	-	-
WGK 25.../WGKV 25...	15.1	5/5	10/15	-	5/5	-	-	-	-	-	-	-	-	-	-	-
WGK 4.../WGKV 4...	8.1	5/8	10/8	-	5/8	8/8	-	-	-	-	-	-	-	-	-	-
WGK 50...	18.8	5/5	-	-	5/5	-	-	-	-	-	-	-	-	-	-	-
WGK 95...	25	5/8	-	-	5/8	-	-	-	-	-	-	-	-	-	-	-
WMA 4...	6	5/6	12/6	-	5/6	12/6	x	x	-	-	-	x	-	-	-	-
WMF 2.5...(BLZ)	5.08	5/5	10/5	-	5/5	8/5	-	-	-	-	-	-	-	-	-	-
WMF 2.5 DI...(PE)/(BLZ)	5.08	5/5	10/5	-	5/5	8/5	-	-	-	-	-	-	-	-	-	-
WMF 2.5 PE...	5.08	5/5	10/5	-	5/5	8/5	-	-	-	-	-	-	-	-	-	-
WMF 2.5 FU...(PE)/(BLZ)	5.08	5/5	10/5	-	5/5	8/5	-	-	-	-	-	-	-	-	-	-
WNT 10	10	5/5	12/5	-	5/5	12/5	x	-	-	-	-	x	-	-	-	-
WNT 16 N	12	5/5	12/5	-	5/5	12/5	x	-	-	-	-	x	-	-	-	-
WNT 2.5	5	5/5	12/5	-	5/5	12/5	x	-	-	-	-	x	-	-	-	-
WNT 35 N	16	5/5	12/5	-	5/5	12/5	x	-	-	-	-	x	-	-	-	-
WNT 4	6	5/6	12/6	-	5/6	12/6	x	-	-	-	-	x	-	-	-	-
WNT 6	8	5/8	12/5	-	5/8	12/5	x	-	-	-	-	x	-	-	-	-

**Selection table Terminal markers**

Designation	Terminal width	DEK	WS	ZS	DEK MM	WS MM	SchT 7	WAD 5	WAD 8	WAD 12	WAD 27	ZGB 15 / ZGB 30	BZT 1	BZT 2	EM 8/30	Other
WNT 70 N	20.5	5/5	12/5	-	5/5	12/5	x	-	-	-	-	x	-	-	-	-
WPDB...		-	-	-	-	-	-	-	-	-	-	-	-	-	-	LM MT3000 15x9 GE
WPD 100...	30.2	-	-	-	-	-	-	-	-	-	-	-	-	-	-	ESG 9/17 K MC SDR
WPD 101...	17.8	-	-	-	-	-	-	-	-	-	-	-	-	-	-	SFX 10/23 MC NE WS V2
WPD 301...	53.4	-	-	-	-	-	-	-	-	-	-	-	-	-	-	SFX 10/23 MC NE WS V2
WPD 401...	81.5	-	-	-	-	-	-	-	-	-	-	-	-	-	-	SFX 10/23 MC NE WS V2
WPD 501...	88.8	-	-	-	-	-	-	-	-	-	-	-	-	-	-	SFX 10/23 MC NE WS V2
WPD 102...	22.2	-	-	-	-	-	-	-	-	-	-	-	-	-	-	HSS 1/2 4.8-11.4/50Y
WPD 202...	44.4	-	-	-	-	-	-	-	-	-	-	-	-	-	-	HSS 1/2 4.8-11.4/50Y
WPD 302...	66.6	-	-	-	-	-	-	-	-	-	-	-	-	-	-	HSS 1/2 4.8-11.4/50Y
WPD 103...	32.9	-	-	-	-	-	-	-	-	-	-	-	-	-	-	SFX 30/60 MC NE WS
WPD 104...	33.3	-	-	-	-	-	-	-	-	-	-	-	-	-	-	ESG 9/17 K MC SDR
WPD 204...	64.5	-	-	-	-	-	-	-	-	-	-	-	-	-	-	ESG 9/17 K MC SDR
WPD 304...	96	-	-	-	-	-	-	-	-	-	-	-	-	-	-	ESG 9/17 K MC SDR
WPD 105...	37.1	-	-	-	-	-	-	-	-	-	-	-	-	-	-	ESG 9/17 K MC SDR
WPD 205...	72.7	-	-	-	-	-	-	-	-	-	-	-	-	-	-	ESG 9/17 K MC SDR
WPD 305...	108.3	-	-	-	-	-	-	-	-	-	-	-	-	-	-	ESG 9/17 K MC SDR
WPD 106...	41	-	-	-	-	-	-	-	-	-	-	-	-	-	-	ESG 9/17 K MC SDR
WPD 107...	52.2	-	-	-	-	-	-	-	-	-	-	-	-	-	-	ESG 9/17 K MC SDR
WPD 108...	52.2	-	-	-	-	-	-	-	-	-	-	-	-	-	-	ESG 9/17 K MC SDR
WPD 109...	52.6	-	-	-	-	-	-	-	-	-	-	-	-	-	-	ESG 9/17 K MC SDR
WPE 1.5/R3.5	3.5	5/3.5	12/3.5	-	5/3.5	12/3.5	-	-	-	-	-	-	-	-	-	-
WPE 1.5/ZZ	5	5/5	12/5	-	5/5	12/5	x	-	-	-	-	x	-	-	-	-
WPE 10...	10	5/5	12/5	-	5/5	12/5	x	-	-	-	-	x	-	-	-	-
WPE 120	32	5/8	12/6.5	-	5/8	-	-	-	-	-	-	-	-	-	-	-
WPE 16	12	5/5	12/5	-	5/5	12/5	x	-	-	-	-	x	-	-	-	-
WPE 16 N	12	5/5	12/5	-	5/5	12/5	x	-	-	-	-	x	-	-	-	-
WPE 2.5 N (WPE 1.5)	5	5/5	12/5	-	5/5	12/5	x	-	-	-	-	x	-	-	-	-
WPE 2.5...	5	5/5	12/5	-	5/5	12/5	x	-	-	-	-	x	-	-	-	-
WPE 2.5/1.5/ZR	5	5/5	12/5	-	5/5	12/5	-	-	-	-	-	-	-	-	-	-
WPE 35...	16	5/5	12/5	-	5/5	12/5	x	-	-	-	-	x	-	-	-	-
WPE 4	6	5/6	12/6	-	5/6	12/6	x	-	-	-	-	x	-	-	-	-
WPE 4N	6	5/6	12/6	-	5/6	12/6	-	-	-	-	-	-	-	-	-	-
WPE 50N	18.5	5/8	12/6.5	-	5/8	-	-	-	-	-	-	-	-	-	-	-
WPE 6	7.9	5/6	12/5	-	5/6	12/5	x	-	-	-	-	x	-	-	-	-
WPE 95N/120N	27	5/8	15/5	-	5/8	12/5	-	-	-	-	-	-	-	-	-	-
WPO 4	6	5/6	10/6	-	5/6	8/6	-	-	-	-	-	x	-	-	-	-
WSI 25...	18	-	-	-	-	-	-	-	-	-	-	-	-	-	-	ESG 6/15
WFS 4...	6	5/6	12/6	-	5/6	12/6	-	-	-	-	-	-	-	-	-	-
WSI 6...	8	5/8	12/5	-	5/8	12/5	-	-	-	-	-	x	-	-	-	-
WSI 6/2...	12	5/8	12/6.5	-	5/8	-	-	-	-	-	-	-	-	-	-	-
WTD 6/1	8	5/8	12/5	-	5/8	12/5	-	-	-	-	-	x	-	-	-	-
WTL 35	16	-	12/6	-	-	12/6	-	-	-	-	-	-	-	-	-	-
WTL 4 ...	6	5/6	12/6	-	5/6	12/6	-	-	-	-	-	-	-	-	-	-
WTL 6/1...	8	5/8	12/8	-	5/8	12/8	-	-	-	-	-	x	-	-	-	-
WTL 6/2	8	5/8	12/8	-	5/8	12/8	-	-	-	-	-	x	-	-	-	-
WTL 6/3...	8	5/8	12/8	-	5/8	12/8	-	-	-	-	-	x	-	-	-	-
WTO 6/1	8	5/8	12/8	-	5/8	12/8	-	-	-	-	-	x	-	-	-	-
WTR 2.5 ...	5	5/5	12/5	-	5/5	12/5	-	-	-	-	-	x	-	-	-	-
WTR 35 E	32	-	12/6	-	-	12/6	-	-	-	-	-	-	-	-	-	-
WTR 4...	6	5/6	12/6	-	5/6	12/6	-	-	-	-	-	-	-	-	-	-
ZAP/TW ZIA 1.5/...	3.8	5/3.5	-	-	5/3.5	-	-	-	-	-	-	-	-	-	-	-
ZDK 1.5...	3.5	5/3.5	12/3.5	-	5/3.5	12/3.5	-	-	-	-	-	-	-	-	-	-
ZDK 2.5...	5	5/5	12/5	5/5	5/5	12/5	-	-	-	-	-	x	-	-	-	-
ZDK 2.5-2...	5	5/5	10/5	10/5	5/5	8/5	-	-	-	-	-	-	-	-	-	-
ZDK 2.5N...	5.1	5/5	10/5	-	5/5	8/5	-	-	-	-	-	-	-	-	-	ZAD 9/4
ZDK 4/S/...	6	5/6	-	12/6	5/6	-	-	-	-	-	-	x	-	-	-	-
ZDK 6/S/...	8	5/8	-	-	5/8	-	-	-	-	-	-	x	-	-	-	-
ZDKPE 2.5	5	5/5	10/5	10/5	5/5	8/5	-	-	-	-	-	-	-	-	-	-
ZDL 2.5/...	5	5/5	-	10/5	5/5	-	-	-	-	-	-	x	-	-	-	-
ZDL 2.5-2...	5	5/5	-	10/5	5/5	-	-	-	-	-	-	x	-	-	-	-
ZDT 2.5 ...	5	5/5	10/5	10/5	5/5	8/5	-	-	-	-	-	-	-	-	-	-
ZDTPE 2.5...	5	5/5	10/5	10/5	5/5	8/5	-	-	-	-	-	-	-	-	-	-
ZDTR 2.5	5	5/5	12/5	15/5	5/5	12/5	-	-	-	-	-	x	-	-	-	-
ZDU (ZPE) 10	10	5/5	12/5	15/5	5/5	12/5	-	-	-	-	-	x	x	x	-	-
ZDU (ZPE) 10/S...	10	5/5	10/5	15/5	5/5	8/5	-	-	-	-	-	x	x	x	-	-
ZDU (ZPE) 16...	12	5/5	12/5	15/5	5/5	12/5	-	-	-	-	-	x	x	x	-	-
ZDU (ZPE) 16/S...	12	5/5	10/5	15/5	5/5	8/5	-	-	-	-	-	x	x	x	-	-
ZDU (ZPE) 2.5 ...	5	5/5	12/5	15/5	5/5	12/5	-	-	-	-	-	x	x	x	-	-

Designation	Terminal width	DEK	WS	ZS	DEK MM	WS MM	SchT 7	WAD 5	WAD 8	WAD 12	WAD 27	ZGB 15 / ZGB 30	BZT 1	BZT 2	EM 8/30	Other
ZDU (ZPE) 2.5-2/...	5	5/5	12/5	15/5	5/5	12/5	-	-	-	-	-	x	-	-	-	-
ZDU (ZPE) 2.5N...	5.1	5/5	10/5	-	5/5	8/5	-	-	-	-	-	-	-	-	-	ZAD 9/4
ZDU (ZPE) 35...	16	5/5	12/5	15/5	5/5	12/5	-	-	-	-	-	x	x	x	-	-
ZDU (ZPE) 4...	6	5/6	12/6	12/6	5/6	12/6	-	-	-	-	-	x	x	x	-	-
ZDU (ZPE) 4-2...	6	5/6	12/6	12/6	5/6	12/6	-	-	-	-	-	-	-	-	-	-
ZDU (ZPE) 6...	8	5/8	12/8	15/5	5/8	12/8	-	-	-	-	-	x	x	x	-	-
ZDU (ZPE) 6-2...	8	5/8	12/8	12/6	5/8	12/8	-	-	-	-	-	-	-	-	-	-
ZDU 1.5...	3.5	5/3.5	12/3.5	-	5/3.5	12/3.5	-	-	-	-	-	-	x	x	-	-
ZDUA (ZPEA) 2.5-2	5	5/5	8/5	15/5	5/5	8/5	-	-	-	-	-	x	-	-	-	-
ZDUA 2.5-2N	5	5/5	10/5	10/5	5/5	8/5	-	-	-	-	-	-	-	-	-	-
ZDUB (ZPEB) 2.5-2/...	5	5/5	8/5	15/5	5/5	8/5	-	-	-	-	-	x	-	-	-	-
ZEI 16	16	5/5	12/5	15/5	5/5	12/5	-	-	-	-	-	x	-	-	-	-
ZEI 6	10	5/8	12/6	12/6	5/8	12/6	-	-	-	-	-	x	x	x	-	-
ZEW 35/2	8	5/8	-	-	5/8	-	-	-	-	-	-	-	-	-	x	-
ZIA 1.5 ...	5.08	5/5	8/5	15/5	5/5	8/5	-	-	-	-	-	x	-	-	-	-
ZMAK 2.5...	5	5/5	10/5	15/5	5/5	8/5	-	-	-	-	-	x	-	-	-	-
ZNT 10/S	10	5/5	-	-	5/5	-	-	-	-	-	-	-	-	-	-	-
ZNT 16/S	12	5/5	-	-	5/5	-	-	-	-	-	-	-	-	-	-	-
ZNT 2.5/S	5	5/5	10/5	10/5	5/5	8/5	-	-	-	-	-	-	-	-	-	-
ZNT 4/S	6	5/6	10/6	12/6	5/6	8/6	-	-	-	-	-	-	-	-	-	-
ZNT 6/S	8	5/8	10/8	12/6	5/8	8/8	-	-	-	-	-	-	-	-	-	-
ZP 2.5...	5.1	5/5	10/5	10/5	5/5	8/5	-	-	-	-	-	-	-	-	-	-
ZPE 16-2/1 AN	12	5/8	12/6	12/6	5/8	12/6	-	-	-	-	-	-	-	-	-	-
ZPV 1.5	5.08	5/5	12/5	15/5	5/5	12/5	-	-	-	-	-	x	-	-	-	-
ZRV 1.5...	5	5/5	8/5	10/5	5/5	8/5	-	-	-	-	-	x	-	-	-	-
ZSI 2.5...	8	5/8	12/5	15/5	5/8	12/5	-	-	-	-	-	x	-	-	-	-
ZSI 2.5/2...	12	5/5	12/5	15/5	5/5	12/5	-	-	-	-	-	x	-	-	-	-
ZSI 6-2/FC	8	5/6	12/6	12/6	5/6	12/6	-	-	-	-	-	-	-	-	-	-
ZT 2.5 ...	5	5/5	10/5	10/5	5/5	8/5	-	-	-	-	-	-	-	-	-	-
ZTD 6	8	5/8	12/6.5	-	5/8	-	-	-	-	-	-	-	-	-	-	-
ZTL 6	8	5/8	12/6.5	-	5/8	-	-	-	-	-	-	-	-	-	-	-
ZTPE 2.5 ...	5	5/5	10/5	10/5	5/5	8/5	-	-	-	-	-	-	-	-	-	-
ZTR 2.5...	5	5/5	12/5	15/5	5/5	12/5	-	-	-	-	-	x	-	-	-	-
ZTR 2.5-2...	5	5/5	14/5	10/5	5/5	12/5	-	-	-	-	-	-	-	-	-	-

# DEK – Dekafix MultiCard

## Universal basics for marking connectors

### Fast installation, individually or combined

Cable and plug-in connectors as well as electronics modules can be quickly and easily marked using Dekafix markers. Intended for short number strings, strip installation is completed in a single step.



PrintJet CONNECT

Plotter MCP Plus 2

Plotter MCP Basic 2

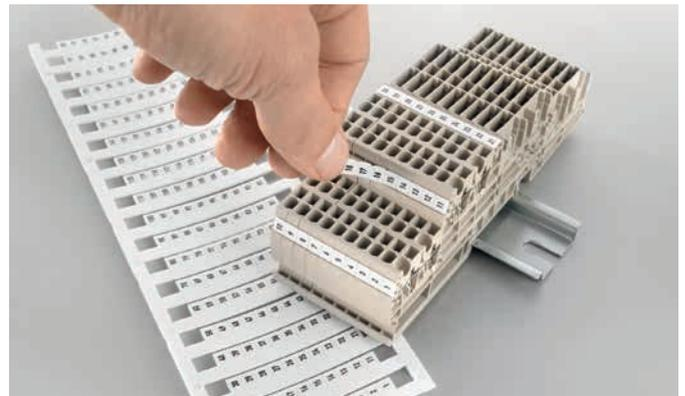

### Dekafix - the benefits to you

- Universal: can be used for sequences of numbers of different lengths and multi-line labelling
- The best orientation: simple assignment thanks to additional information on the project marking surface
- Easy to install: simple snap-on feature for individual or multiple signs
- High contrast: the best printed image and easy to read

You have a project marking surface on the MultiCard format for additional information which makes assignment during assembly much simpler.



As an option it is also available without the project marking surface: the plus-series versions come in whole strips for particularly fast assembly.



### Technical data

Material	Polyamide 66, halogen-free
UL 94 flammability rating	V2
Temperature range	-40 °C to 100 °C

### Ordering data

Colour	International colour code colours, not contained in the range, are available on request.
Special printing	Specify special printing and colours per using the M-Print® PRO software.
Printing	Black or colour
Possible printing systems	PrintJet CONNECT, PrintJet ADVANCED, MCP Plus 2, MCP Basic 2
Notes on mounting	Mount in strips when the marker pitch (width) corresponds to the pitch of the terminals. For example, DEK 5 mm pitch for terminals with 5 mm pitch such as the WDU 2.5. Mount individual markers when the terminal pitch is larger than the marker pitch (width). For example, DEK 6.5 mount individually on WDU 6 terminals.
Minimum order quantity	1 pack = 5 cards



**DEK MultiCard – markers for terminals and connectors**

**Dekafix MultiCard**

**DEK 5/5**

**5 mm**

**DEK 5/5 PLUS**

**5 mm**

Terminal marker



Terminal marker



**Technical data**

Material
Fire class acc. to UL 94
Ambient temperature (operational)
Width
Height
<b>Note</b>

Polyamide 66
V-2
-40 °C...100 °C
5 mm
5 mm

Polyamide 66
V-2
-40 °C...100 °C
5 mm
5 mm

**Ordering data**

MultiCard Blank	
white	○
blue	●
grey	●
green	●
yellow	●
red	●
orange	●
MultiCard custom printing	
To customer specification	
<b>Note</b>	

Type	Qty.	Order No.
DEK 5/5 MC NE WS	1000	1609801044
DEK 5/5 MC NE BL	1000	1609801693
DEK 5/5 MC NE GR	1000	1609801691
DEK 5/5 MC NE GN	1000	1609801688
DEK 5/5 MC NE GE	1000	1609801687
DEK 5/5 MC NE RT	1000	1609801686
DEK 5/5 MC NE OR	1000	1238340000
DEK 5/5 MC SDR	200	1609810000
Please send M-Print PRO file		

Type	Qty.	Order No.
DEK 5/5 PLUS MC NE WS	1000	1854490000
DEK 5/5 PLUS MC NE GE	1000	1907520000
DEK 5/5 PLUS MC SDR	200	1854500000
Please send M-Print PRO file		

**Technical drawing / application**









**Dekafix MultiCard**

**DEK 5/6.5 PLUS**

**6.5 mm**

**DEK 5/7.5**

**7.5 mm**

Terminal marker

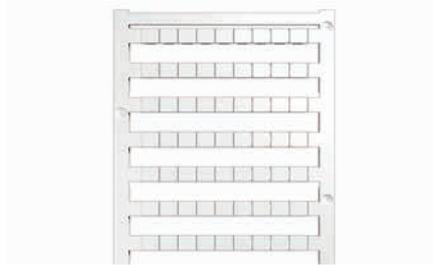

Terminal marker



**Technical data**

Material	Polyamide 66
Fire class acc. to UL 94	V-2
Ambient temperature (operational)	-40 °C...100 °C
Width	6.5 mm
Height	5 mm
<b>Note</b>	

Material	Polyamide 66
Fire class acc. to UL 94	V-2
Ambient temperature (operational)	-40 °C...100 °C
Width	7.5 mm
Height	5 mm
<b>Note</b>	

Material	Polyamide 66
Fire class acc. to UL 94	V-2
Ambient temperature (operational)	-40 °C...100 °C
Width	7.5 mm
Height	5 mm
<b>Note</b>	

**Ordering data**

MultiCard Blank	
white	○
blue	●
grey	●
green	●
yellow	●
red	●
orange	●
MultiCard custom printing	
To customer specification	
<b>Note</b>	

Type	Qty.	Order No.
DEK 5/6.5 PLUS MC NE WS	900	<b>1046340000</b>
DEK 5/6.5 PLUS MC NE GE	900	<b>1364020000</b>
DEK 5/6.5 PLUS MC SDR	180	<b>1046360000</b>
Please send M-Print PRO file		

Type	Qty.	Order No.
DEK 5/7.5 MC NE WS	320	<b>1720620000</b>
DEK 5/7.5 MC SDR	64	<b>1770490000</b>
Please send M-Print PRO file		

**Technical drawing / application**





**Dekafix MultiCard**

**DEK 5/8-11.5**

**8 mm**

**DEK 5/30**

**30 mm**

Terminal marker



Terminal marker



**Technical data**

Material
Fire class acc. to UL 94
Ambient temperature (operational)
Width
Height
<b>Note</b>

Polyamide 66
V-2
-40 °C...100 °C
8 mm
5 mm

Polyamide 66
V-2
-40 °C...100 °C
30 mm
5 mm

**Ordering data**

Width	Colour
<b>MultiCard Blank</b>	
8 mm	○ white
<b>MultiCard custom printing</b>	
<b>Note</b>	

Type	Qty.	Order No.
DEK 5/8-11.5 MC NE WS	500	<b>1341630000</b>

Type	Qty.	Order No.
DEK 5/30 MC NE WS	100	<b>1951920000</b>
DEK 5/30 MC SDR	40	<b>1025680000</b>

**Technical drawing / application**



# WS MultiCard

## Custom design for long character strings

### Fast installation, individually or combined

Specifically for the W-series cable connectors, the WS markers were developed. There is enough space on the printing area for long and individual character strings, even for multi-line layouts. The fact that the WS signs are system compatible means that you can use them also for the complete universal range Klippon® Connect. The MultiCard format means that the WS marker can be labelled with both the PrintJet CONNECT inkjet printer and with plotters.

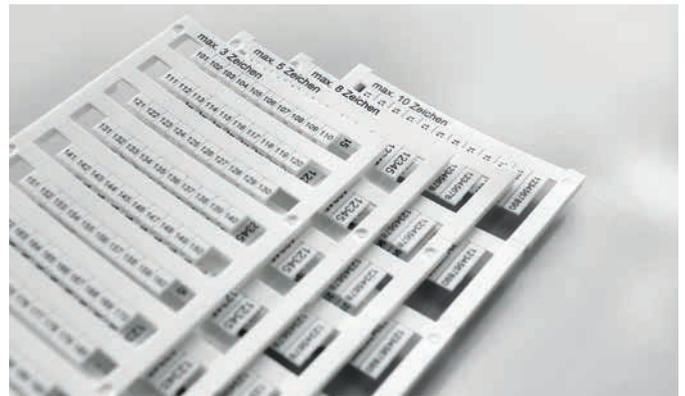
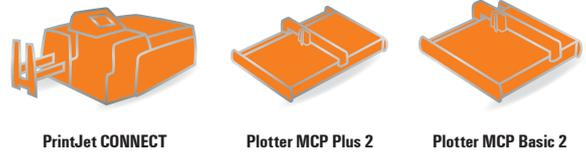

Between 3 to 10 characters which are easy to read fit on the WS markers (marker length: 5 to 15 mm).

### WS markers - the benefits to you

- Universal: can be used for sequences of numbers of different lengths and multi-line labelling
- The best orientation: simple assignment thanks to additional information on the project marking surface
- Easy to install: simple snap-on feature for individual or multiple signs
- High contrast: the best printed image and easy to read

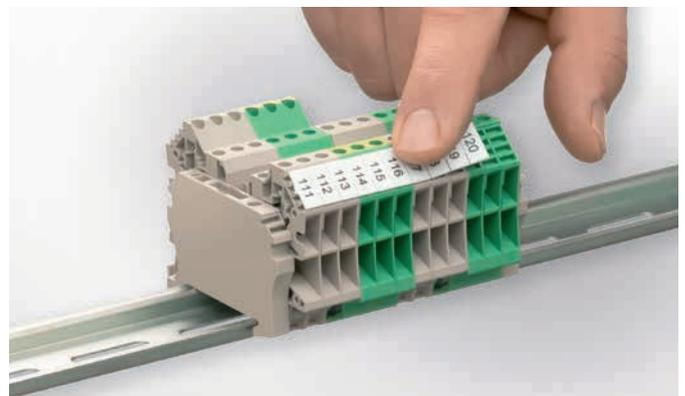

As an option it is also available without the project marking surface: the plus series versions come in whole strips for particularly fast assembly.



### Technical data

Material	Polyamide 66, halogen-free
UL 94 flammability rating	V2
Temperature range	-40 °C to 100 °C

### Ordering data

Colour	International colour code colours, not contained in the range, are available on request.
Special printing	Specify special printing and colours per using the M-Print® PRO software.
Printing	Black or colour
Possible printing systems	PrintJet CONNECT, PrintJet ADVANCED, MCP Plus 2, MCP Basic 2
Minimum order quantity	1 pack = 5 cards

**WS MultiCard**

**WS 10/3.5 PLUS**

**3.5 mm**

**WS 12/3.5**

**3.5 mm**

Terminal marker

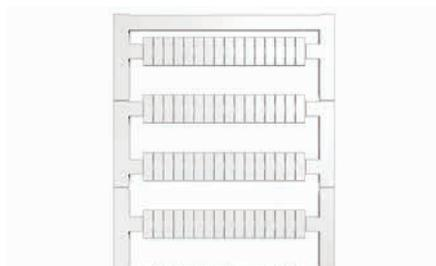

Terminal marker



**Technical data**

Material
Fire class acc. to UL 94
Ambient temperature (operational)
Width
Height
<b>Note</b>

Polyamide 66
V-2
-40 °C...100 °C
3.5 mm
10 mm

Polyamide 66
V-2
-40 °C...100 °C
3.5 mm
12 mm

**Ordering data**

MultiCard Blank	
white	○
blue	●
yellow	●
orange	●
red	●
green	●
violet	●
brown	●
grey	●
MultiCard custom printing	
To customer specification	
<b>Note</b>	

Type	Qty.	Order No.
WS 10/3.5 PLUS MC NE WS	960	<b>2003760000</b>
MultiCard custom printing		
WS 10/3.5 PLUS MC SDR	192	<b>2007760000</b>
Please send M-Print PRO file		

Type	Qty.	Order No.
WS 12/3.5 MC NE WS	600	<b>1778270000</b>
MultiCard custom printing		
WS 12/3.5 MC SDR	120	<b>1778280000</b>
Please send M-Print PRO file		

**Technical drawing / application**





**WS MultiCard**

**WS 10/5**

**5 mm**

**WS 10/5 PLUS**

**5 mm**

Terminal marker



Terminal marker

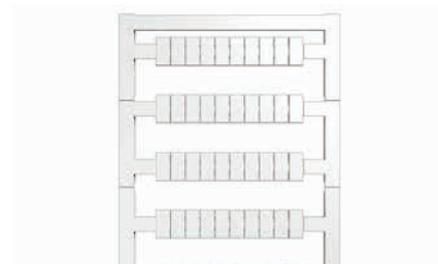

**Technical data**

Material
Fire class acc. to UL 94
Ambient temperature (operational)
Width
Height
<b>Note</b>

Polyamide 66
V-2
-40 °C...100 °C
5 mm
10 mm

Polyamide 66
V-2
-40 °C...100 °C
5 mm
10 mm

**Ordering data**

<b>MultiCard Blank</b>	
white	○
blue	●
yellow	●
orange	●
red	●
green	●
violet	●
brown	●
grey	●
<b>MultiCard custom printing</b>	
To customer specification	
<b>Note</b>	

Type	Qty.	Order No.
WS 10/5 MC NE WS	720	1635000000
WS 10/5 MC NE BL	720	1773531693
WS 10/5 MC NE GE	720	1773531687
WS 10/5 MC NE RT	720	1773531686
WS 10/5 MC SDR	144	1635010000

Please send M-Print PRO file

Type	Qty.	Order No.
WS 10/5 PLUS MC NE WS	600	1046380000
WS 10/5 PLUS MC SDR	120	1046320000

Please send M-Print PRO file

**Technical drawing / application**



**WS MultiCard – markers for the universal range for Klippon® Connect**

**WS MultiCard**

**WS 10/5 M**

**5 mm**

**WS 10/5 M PLUS**

**5 mm**

Terminal marker



Terminal marker

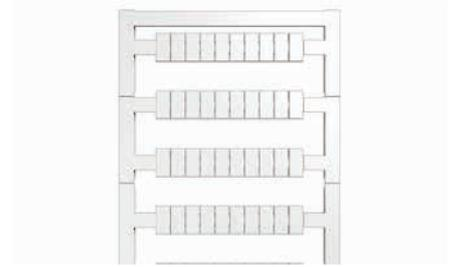

**Technical data**

Material
Fire class acc. to UL 94
Ambient temperature (operational)
Width
Height
<b>Note</b>

Polyamide 66
V-2
-40 °C...100 °C
5 mm
10 mm

Polyamide 66
V-2
-40 °C...100 °C
5 mm
10 mm

**Ordering data**

MultiCard Blank	
white	○
blue	●
yellow	●
orange	●
red	●
green	●
violet	●
brown	●
grey	●
MultiCard custom printing	
To customer specification	
<b>Note</b>	

Type	Qty.	Order No.
WS 10/5 M MC NE WS	720	1792000000
MultiCard custom printing		
WS 10/5 MC M SDR	144	1792010000
Please send M-Print PRO file		

Type	Qty.	Order No.
WS 10/5 M PLUS MC NE WS	600	2003770000
MultiCard custom printing		
WS 10/5 M PLUS MC SDR	120	2007770000
Please send M-Print PRO file		

**Technical drawing / application**



















**WS MultiCard – markers for the universal range for Klippon® Connect**

**WS MultiCard**

**WS 7.8/9.2 PLUS**

**9.2 mm**

**WS 10/12**

**12 mm**

Terminal marker



Terminal marker



**Technical data**

Material
Fire class acc. to UL 94
Ambient temperature (operational)
Width
Height
<b>Note</b>

Polyamide 66
V-2
-40 °C...100 °C
9.2 mm
7.8 mm

Polyamide 66
V-2
-40 °C...100 °C
12 mm
10 mm

**Ordering data**

<b>MultiCard Blank</b>
white ○
blue ●
yellow ●
orange ●
red ●
green ●
violet ●
brown ●
grey ●
<b>MultiCard custom printing</b>
To customer specification
<b>Note</b>

Type	Qty.	Order No.
WS 7.8/9.2 PLUS MC NE GR	360	1208970000
WS 7.8/9.2 PLUS MC SDR	72	1270640000
For Weidmüller PRV. Please send M-Print PRO file		

Type	Qty.	Order No.
WS 10/12 MC NE WS	300	1905970000
WS 10/12 MC SDR	60	1906060000
Please send M-Print PRO file		

**Technical drawing / application**







**PM MultiCard – markers for compact plug-in connectors**

**PM MultiCard**

**PM 2.7/2.6**

**2.6 mm**

Terminal marker

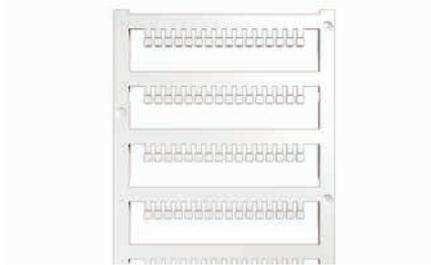

**Technical data**

Material
Fire class acc. to UL 94
Ambient temperature (operational)
Width
Height
<b>Note</b>

Polyamide 66
V-2
-40 °C...100 °C
2.6 mm
2.7 mm

**Ordering data**

<b>MultiCard Blank</b>
white <input type="radio"/>
<b>MultiCard custom printing</b>
To customer specification
<b>Note</b>

Type	Qty.	Order No.
PM 2.7/2.6 MC NE WS	960	<b>1323710000</b>
PM 2.7/2.6 MC SDR	192	<b>1323700000</b>

**Technical drawing / application**



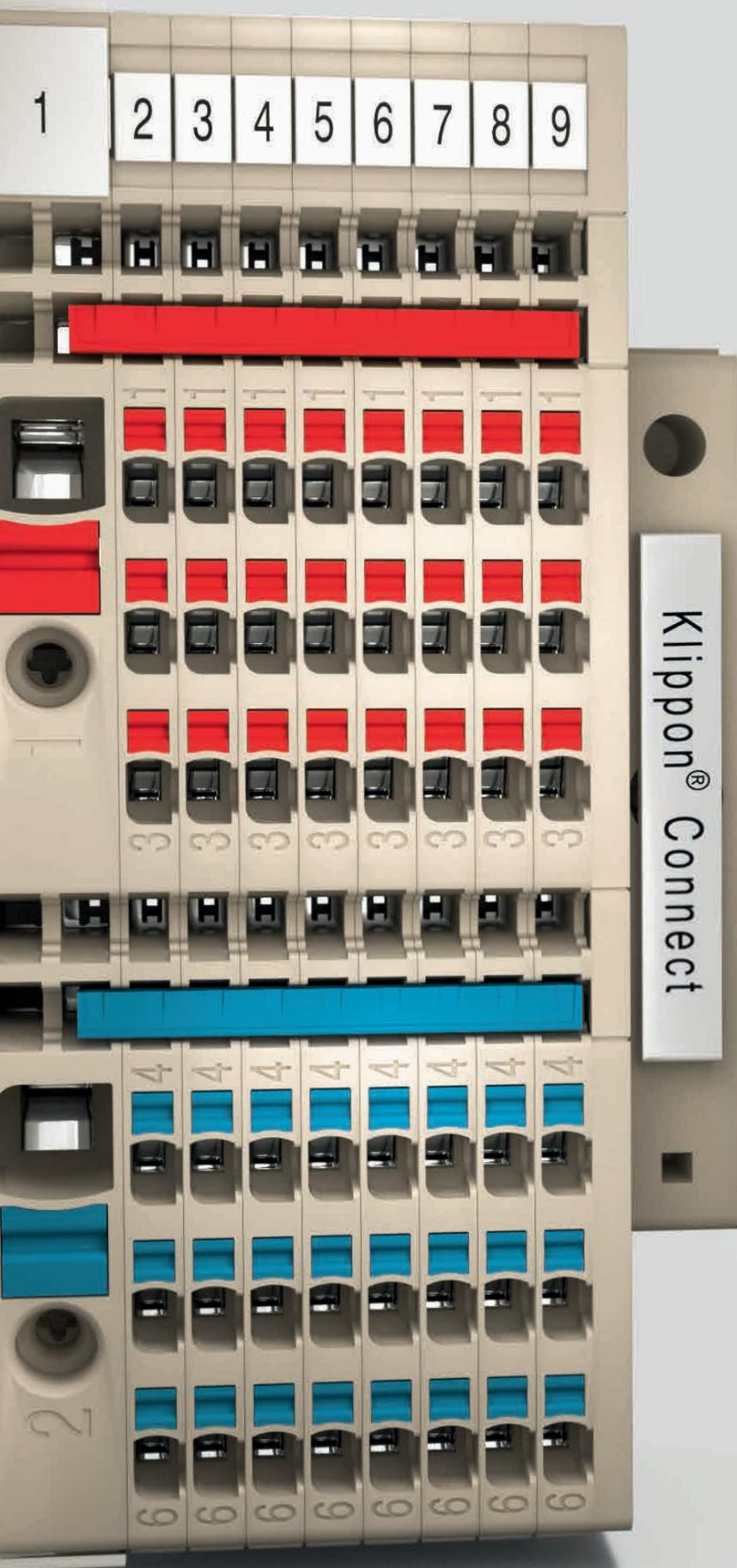

# ZS MultiCard

## Amazing functionality thanks to time-saving folding mechanism

### An extensive marking area and distinct handling advantages

The ZS markers were specially designed for the Z-series, their functionality stands out thanks to a time-saving folding mechanism: without removing the markers, cross-connectors are still easily accessible. This is an advantage in terms of handling when it comes to quick exchanges or fast assembly. Fitted with the proven snap-on system, individual signs or whole strips can be fitted in the fastest possible time; their large marking surface means that they provide absolutely legible labelling.

### ZS – the benefits to you

- Intelligent: foldable hinges for the best possible assembly process with cross-connectors
- Optimised: large labelling surfaces give you the best overview
- Application-specific: tried-and-tested MultiCard format markers

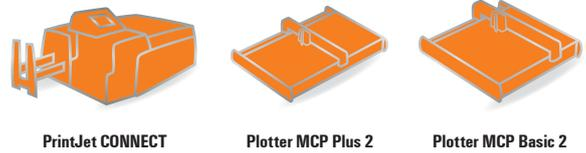

Foldable hinges for easy assembly of cross-connectors; shield lengths of up to 15 mm for long series of characters.

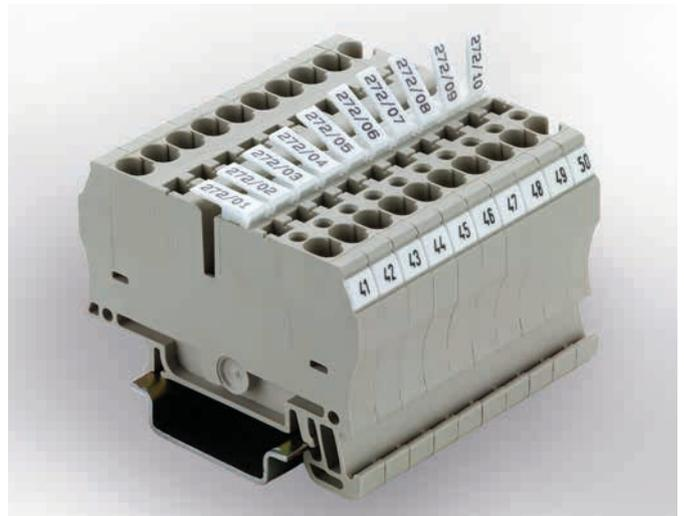

### Technical data

Material	Polyamide 66, halogen-free
UL 94 flammability rating	V2
Temperature range	-40 °C to 100 °C

### Ordering data

Colour	International colour code colours, not contained in the range, are available on request.
Special printing	Specify special printing and colours per using the M-Print® PRO software.
Printing	Black or colour
Possible printing systems	PrintJet CONNECT, PrintJet ADVANCED, MCP Plus 2, MCP Basic 2
Minimum order quantity	1 pack = 5 cards

C

ZS MultiCard

ZS 10/5

5 mm

ZS 15/5

5 mm

Terminal marker

Terminal marker



Technical data

Material
Fire class acc. to UL 94
Ambient temperature (operational)
Width
Height
<b>Note</b>

Polyamide 66
V-2
-40 °C...100 °C
5 mm
10 mm

Polyamide 66
V-2
-40 °C...100 °C
5 mm
15 mm

Ordering data

<b>MultiCard Blank</b>
white ○
<b>MultiCard custom printing</b>
To customer specification
<b>Note</b>

Type	Qty.	Order No.
ZS 10/5 MC NE WS	480	1610000000
ZS 10/5 MC SDR	96	1610010000

Please send M-Print PRO file

Type	Qty.	Order No.
ZS 15/5 MC NE WS	480	1646630000
ZS 15/5 MC SDR	480	1646640000

Please send M-Print PRO file

Technical drawing / application



**ZS MultiCard – markers for Z series modular terminals**

**ZS MultiCard**

**ZS 12/6**

**6 mm**

**ZS 30/5**

**5 mm**

Terminal marker

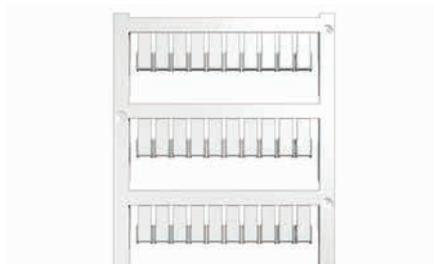

Terminal marker



**Technical data**

Material
Fire class acc. to UL 94
Ambient temperature (operational)
Width
Height
<b>Note</b>

Polyamide 66
V-2
-40 °C...100 °C
6 mm
12 mm

PA 66
V-2
-40 °C...100 °C
5 mm
30 mm

**Ordering data**

<b>MultiCard Blank</b>
white <input type="radio"/>
<b>MultiCard custom printing</b>
To customer specification
<b>Note</b>

Type	Qty.	Order No.
ZS 12/6 MC NE WS	400	<b>1610020000</b>
ZS 12/6 MC SDR	80	<b>1610030000</b>
Please send M-Print PRO file		

Type	Qty.	Order No.
ZS 30/5 MC NE WS	200	<b>2681880000</b>
ZS 30/5 MC SDR	40	<b>2682070000</b>
Please send M-Print PRO file		

**Technical drawing / application**





# MF – MultiFit MultiCard

## For manufacturer-independent marking

### The adaptable range of markers

For manufacturer-independent marking of components, we have developed the adaptable MultiFit marker range. Without having to give up the highly professional printing you get with Weidmüller's marking system, you can use the other manufacturer's components that you are used to, if you wish, and combine them with Weidmüller's MultiFit markers. Designed for the clamping devices of different vendors, these markers fit seamlessly into your marking tasks and solve your desired labelling jobs admirably. MultiFit markers are suitable for components made by the following manufacturers: Allen-Bradley, Beckhoff, Cabur, Entelec, Festo, Legrand, Murrelektronik, Phoenix Contact, Siemens, Telemecanique, Wago, Wieland and Woertz.

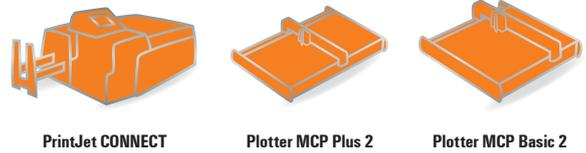

Manufacturer-independent marking: almost complete coverage of all major components on the market.

### MultiFit – the benefits to you

- In line with market requirements: for components from 14 of the best-known manufacturers.
- Can be integrated: suitable for a variety of terminals
- High-quality printing using Weidmüller's marking system



A MultiFit sample box contains all the variants of the markers and helps you when planning the application by giving you the option of checking MultiFit markers to be used against your chosen components. Order No. 1166330000



### Technical data

Material	Polyamide 66, halogen-free
UL 94 flammability rating	V2
Temperature range	-40 °C to 100 °C

### Ordering data

Colour	International colour code colours, not contained in the range, are available on request.
Special printing	Specify special printing and colours per using the M-Print® PRO software.
Printing	Black or colour
Possible printing systems	PrintJet CONNECT, PrintJet ADVANCED, MCP Plus 2, MCP Basic 2
Minimum order quantity	1 pack = 5 cards



Application options

					
	MF 5/3.5 MF 5/4 MF 5/5 MF 5/6 MF 5/7.5 MF 5/10 MF 5/12	MF-W 5/5 Mini	MF-W 9/4 MF-W 9/5 MF-W 9/6	MF-W 9/5 F MF-W 9/4.2 F MF-W 9/5.2 F MF-W 9/6.2 F	
Wago		● Similar to the WagoMini WSB Type 248...264...	● Similar to the Wago WSB Type 209...249...	● Similar to the Wago WMB Type 793...794... For Wago Tob Job S	
Phoenix	●				
Wieland					
Legrand		●	●	●	
Entrelec		●			
Télemecanique					
					
	MF 8/5 MF 10/5 MF 12/5 MF 10/6	MF 10/8 MF 10/10	MF 4/5.2	MF 5/7.5	
Wago	●				
Phoenix	●	● ZB 8 ZB 10	● BN-ZB 5.2	● BN-ZB 7.5	
Wieland	●				
Legrand	●				
Entrelec	●				
Télemecanique	●	●			
Adels RKW				● BZ 14	
					
	MF 10/5 CABUR MF 12/5 CABUR	MF-SI	MF-WO	MFF	MF-ABB 12/5 MF-ABB 12/6 MF-ABB 12/8
Siemens		●			
Woertz			●		
Festo				●	
Cabur	● Cabur				
ABB					● ZS4... ZS6... ZS8... SNK Series

● = OK  
(Please select the marker according to the width of the terminal)

**Please note:**  
The recommended applications given above do not release the user from his obligation to check the applicability in each individual application. The marker/terminal combination should, in each case, be chosen in such a way, that either the marker pitch matches the terminal pitch, or the marker pitch is smaller than the terminal pitch.

**MF MultiCard – markers for use with other makes of terminals**

**MF MultiCard**

**MF 5/3.5**

**3.5 mm**

**MF 5/4**

**4 mm**

Terminal marker



Terminal marker



**Technical data**

Material
Fire class acc. to UL 94
Ambient temperature (operational)
Application/manufacturer
Width
Height
<b>Note</b>

Polyamide 66
V-2
-40 °C...100 °C
Phoenix
3.5 mm
5 mm

Polyamide 66
V-2
-40 °C...100 °C
Phoenix
4 mm
5 mm

**Ordering data**

<b>MultiCard Blank</b>
white ○
<b>MultiCard custom printing</b>
To customer specification
<b>Note</b>

Type	Qty.	Order No.
MF 5/3.5 MC NE WS	800	<b>1521010000</b>
MF 5/3.5 MC SDR	800	<b>1525840000</b>
Please send M-Print PRO file		

Type	Qty.	Order No.
MF 5/4 MC NE WS	500	<b>1877690000</b>
MF 5/4 MC SDR	100	<b>1877670000</b>
Please send M-Print PRO file		

**Technical drawing / application**



**MF MultiCard**

**MF 5/5**

**5 mm**

Terminal marker



**Technical data**

Material	
Fire class acc. to UL 94	
Ambient temperature (operational)	
Application/manufacturer	
Width	
Height	
<b>Note</b>	

Polyamide 66
V-2
-40 °C...100 °C
Phoenix
5 mm
5 mm

**Ordering data**

<b>MultiCard Blank</b>	
white	○
<b>MultiCard custom printing</b>	
To customer specification	
<b>Note</b>	

Type	Qty.	Order No.
MF 5/5 MC NE WS	500	<b>1816250000</b>
MF 5/5 MC SDR	100	<b>1816320000</b>
Please send M-Print PRO file		

**Technical drawing / application**



**MF MultiCard – markers for use with other makes of terminals**

**MF MultiCard**

**MF 8/5**

**5 mm**

**MF 10/5**

**5 mm**

Terminal marker

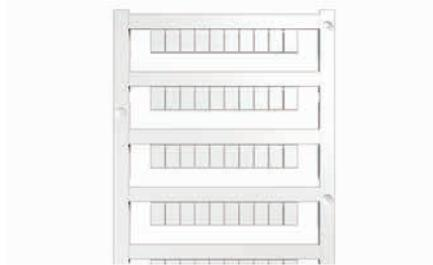

Terminal marker



**Technical data**

Material
Fire class acc. to UL 94
Ambient temperature (operational)
Application/manufacturer
Width
Height
<b>Note</b>

Polyamide 66
V-2
-40 °C...100 °C
Phoenix, Wieland, Legrand, Telemecanique, Entelec, WAGO
5 mm
8 mm

Polyamide 66
V-2
-40 °C...100 °C
Phoenix, Wieland, Legrand, Telemecanique, Entelec
5 mm
10 mm

**Ordering data**

<b>MultiCard Blank</b>
white ○
<b>MultiCard custom printing</b>
To customer specification
<b>Note</b>

Type	Qty.	Order No.
MF 8/5 MC NE WS	600	<b>1677140000</b>
MF 8/5 MC SDR	120	<b>1677150000</b>
Please send M-Print PRO file		

Type	Qty.	Order No.
MF 10/5 MC NE WS	600	<b>1677160000</b>
MF 10/5 MC SDR	120	<b>1677170000</b>
Please send M-Print PRO file		

**Technical drawing / application**



**MF MultiCard**

**MF 10/5 CABUR**

**5 mm**

**MF 12/5**

**5 mm**

Terminal marker



Terminal marker



**Technical data**

Material
Fire class acc. to UL 94
Ambient temperature (operational)
Application/manufacturer
Width
Height
<b>Note</b>

Polyamide 66
V-2
-40 °C...100 °C
Cabur
5 mm
10 mm

Polyamide 66
V-2
-40 °C...100 °C
Phoenix, Wieland, Legrand, Telemecanique, Entrelec, WAGO
5 mm
12 mm

**Ordering data**

<b>MultiCard Blank</b>
white <input type="radio"/>
<b>MultiCard custom printing</b>
To customer specification
<b>Note</b>

Type	Qty.	Order No.
MF 10/5 CABUR MC NE WS	600	<b>1854510000</b>
Please send M-Print PRO file		

Type	Qty.	Order No.
MF 12/5 MC NE WS	600	<b>1677180000</b>
MF 12/5 MC SDR	120	<b>1677190000</b>
Please send M-Print PRO file		

**Technical drawing / application**



**MF MultiCard – markers for use with other makes of terminals**

**MF MultiCard**

**MF 12/5 CABUR**

**5 mm**

**MF 4/5.2**

**5.2 mm**

Terminal marker



Terminal marker



**Technical data**

Material
Fire class acc. to UL 94
Ambient temperature (operational)
Application/manufacturer
Width
Height
<b>Note</b>

Polyamide 66
V-2
-40 °C...100 °C
Cabur
5 mm
12 mm

Polyamide 66
V-2
-40 °C...100 °C
Phoenix
5.2 mm
4 mm

**Ordering data**

<b>MultiCard Blank</b>
white ○
<b>MultiCard custom printing</b>
To customer specification
<b>Note</b>

Type	Qty.	Order No.
MF 12/5 CABUR MC NE WS	600	<b>1854520000</b>
MF 12/5 MC CABUR SDR	120	<b>1038670000</b>
Please send M-Print PRO file		

Type	Qty.	Order No.
MF 4/5.2 MC NE WS	500	<b>1907530000</b>
MF 4/5.2 MC SDR	100	<b>1038690000</b>
Please send M-Print PRO file		

**Technical drawing / application**



**MF MultiCard**

**MF 5/6**

**6 mm**

**MF 10/6**

**6 mm**

Terminal marker



Terminal marker



**Technical data**

Material
Fire class acc. to UL 94
Ambient temperature (operational)
Application/manufacturer
Width
Height
<b>Note</b>

Polyamide 66
V-2
-40 °C...100 °C
Phoenix
6 mm
5 mm

Polyamide 66
V-2
-40 °C...100 °C
Phoenix, Wieland, Legrand, Telemecanique, Entrelec
6 mm
10 mm

**Ordering data**

<b>MultiCard Blank</b>
white ○
<b>MultiCard custom printing</b>
To customer specification
<b>Note</b>

Type	Qty.	Order No.
MF 5/6 MC NE WS	500	<b>1816260000</b>
MF 5/6 MC SDR	100	<b>1816330000</b>
Please send M-Print PRO file		

Type	Qty.	Order No.
MF 10/6 MC NE WS	600	<b>1677220000</b>
MF 10/6 MC SDR	120	<b>1677230000</b>
Please send M-Print PRO file		

**Technical drawing / application**



**MF MultiCard – markers for use with other makes of terminals**

**MF MultiCard**

**MF 5/7.5**

**7.5 mm**

**MF 10/8**

**8 mm**

Terminal marker



Terminal marker

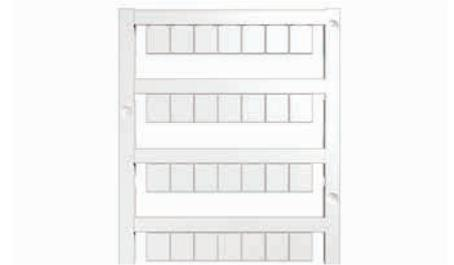

**Technical data**

Material
Fire class acc. to UL 94
Ambient temperature (operational)
Application/manufacturer
Width
Height
<b>Note</b>

Polyamide 66
V-2
-40 °C...100 °C
Adels RKW, Phoenix
7.5 mm
5 mm

Polyamide 66
V-2
-40 °C...100 °C
Phoenix, Entrelec
8 mm
10 mm

**Ordering data**

<b>MultiCard Blank</b>
white ○
<b>MultiCard custom printing</b>
To customer specification
<b>Note</b>

Type	Qty.	Order No.
MF 5/7.5 MC NE WS	320	<b>1877680000</b>
MF 5/7.5 MC SDR	64	<b>1877660000</b>
Please send M-Print PRO file		

Type	Qty.	Order No.
MF 10/8 MC NE WS	350	<b>1868440000</b>
MF 10/8 MC SDR	70	<b>1868430000</b>
Please send M-Print PRO file		

**Technical drawing / application**





MF MultiCard

MF 5/10

10 mm

MF 10/10

10 mm

Terminal marker



Terminal marker



Technical data

Material
Fire class acc. to UL 94
Ambient temperature (operational)
Application/manufacturer
Width
Height
Note

Polyamide 66
V-2
-40 °C...100 °C
Phoenix
10 mm
5 mm

Polyamide 66
V-2
-40 °C...100 °C
Phoenix, Entelec
10 mm
10 mm

Ordering data

<b>MultiCard Blank</b>
white ○
<b>MultiCard custom printing</b>
To customer specification
Note

Type	Qty.	Order No.
MF 5/10 MC NE WS	250	1954050000
MF 5/10 MC SDR	1	1038730000
Please send M-Print PRO file		

Type	Qty.	Order No.
MF 10/10 MC NE WS	200	1856760000
MF 10/10 MC SDR	40	1856770000
Please send M-Print PRO file		

Technical drawing / application



**MF MultiCard – markers for use with other makes of terminals**

**MF MultiCard**

**MF 5/12**

**12 mm**

Terminal marker



**Technical data**

Material
Fire class acc. to UL 94
Ambient temperature (operational)
Application/manufacturer
Width
Height
<b>Note</b>

Polyamide 66
V-2
-40 °C...100 °C
Phoenix
12 mm
5 mm

**Ordering data**

<b>MultiCard Blank</b>
white ○
<b>MultiCard custom printing</b>
To customer specification
<b>Note</b>

Type	Qty.	Order No.
MF 5/12 MC NE WS	250	<b>1250090000</b>
MF 5/12 MC SDR	50	<b>1250080000</b>
Please send M-Print PRO file		

**Technical drawing / application**



**MF MultiCard**

**MFF 9/4**

**4 mm**

**MFF 10/6**

**6 mm**

Terminal marker

Terminal marker

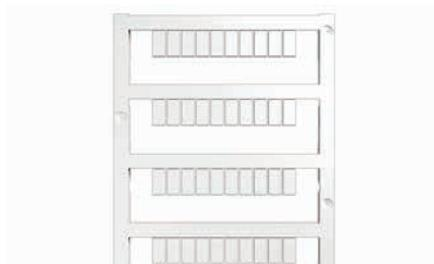

**Technical data**

Material
Fire class acc. to UL 94
Ambient temperature (operational)
Application/manufacturer
Width
Height
<b>Note</b>

Polyamide 66
V-2
-40 °C...100 °C
Festo
4 mm
9 mm

Polyamide 66
V-2
-40 °C...100 °C
Festo
6 mm
10 mm

**Ordering data**

<b>MultiCard Blank</b>
white <span style="float: right;">○</span>
yellow <span style="float: right;">●</span>
<b>MultiCard custom printing</b>
To customer specification
<b>Note</b>

Type	Qty.	Order No.
MFF 9/4 MC NE WS	500	<b>1877720000</b>
MFF 9/4 MC SDR	100	<b>1877700000</b>
Please send M-Print PRO file		

Type	Qty.	Order No.
MFF 10/6 MC NE WS	600	<b>1856780000</b>
MFF 10/6 MC NE GE	600	<b>1957340000</b>
MFF 10/6 MC SDR	120	<b>1856790000</b>
Please send M-Print PRO file		

**Technical drawing / application**



**MF MultiCard – markers for use with other makes of terminals**

**MF MultiCard**

**MF-W 9/3.5**

**3.5 mm**

**MF-W 9/4**

**4 mm**

Terminal marker

Terminal marker



**Technical data**

Material
Fire class acc. to UL 94
Ambient temperature (operational)
Application/manufacturer
Width
Height
<b>Note</b>

Polyamide 66
V-2
-40 °C...100 °C
WAGO
3.5 mm
9 mm

Polyamide 66
V-2
-40 °C...100 °C
WAGO, Legrand
4 mm
9 mm

**Ordering data**

<b>MultiCard Blank</b>
white ○
<b>MultiCard custom printing</b>
To customer specification
<b>Note</b>

Type	Qty.	Order No.
MF-W 9/3.5F MC NE WS	800	<b>1521040000</b>
MF-W 9/3.5F MC SDR	800	<b>1525830000</b>
Please send M-Print PRO file		

Type	Qty.	Order No.
MF-W 9/4 MC NE WS	500	<b>1877730000</b>
MF-W 9/4 MC SDR	100	<b>1877710000</b>
Please send M-Print PRO file		

**Technical drawing / application**



**MF MultiCard**

**MF-W 9/4.2F**

**4.2 mm**

Terminal marker



**Technical data**

Material	Polyamide 66
Fire class acc. to UL 94	V-2
Ambient temperature (operational)	-40 °C...100 °C
Application/manufacturer	WAGO, Legrand
Width	4.2 mm
Height	9 mm
<b>Note</b>	

Material	Polyamide 66
Fire class acc. to UL 94	V-2
Ambient temperature (operational)	-40 °C...100 °C
Application/manufacturer	WAGO, Legrand
Width	4.2 mm
Height	9 mm
<b>Note</b>	

**Ordering data**

<b>MultiCard Blank</b>	
white	○
<b>MultiCard custom printing</b>	
To customer specification	
<b>Note</b>	

Type	Qty.	Order No.
MF-W 9/4.2F MC NE WS	500	<b>1011430000</b>
MF-W 9/4.2F MC SDR	100	<b>1038750000</b>
Please send M-Print PRO file		

**Technical drawing / application**



**MF MultiCard – markers for use with other makes of terminals**

**MF MultiCard**

**MF-W 9/5**

**5 mm**

**MF-W 9/5F**

**5 mm**

Terminal marker



Terminal marker



**Technical data**

Material
Fire class acc. to UL 94
Ambient temperature (operational)
Application/manufacturer
Width
Height
<b>Note</b>

Polyamide 66
V-2
-40 °C...100 °C
WAGO, Legrand
5 mm
9 mm

Polyamide 66
V-2
-40 °C...100 °C
WAGO, Legrand
5 mm
9 mm

**Ordering data**

<b>MultiCard Blank</b>
yellow ●
white ○
grey ●
<b>MultiCard custom printing</b>
To customer specification
<b>Note</b>

Type	Qty.	Order No.
MF-W 9/5 MC NE GE	500	<b>1027310000</b>
MF-W 9/5 MC NE WS	500	<b>1816270000</b>
MF-W 9/5 MC SDR	100	<b>1816340000</b>
Please send M-Print PRO file		

Type	Qty.	Order No.
MF-W 9/5F MC NE WS	500	<b>1816280000</b>
MF-W 9/5F MC NE GR	500	<b>1045980000</b>
MF-W 9/5F MC SDR	100	<b>1816350000</b>
Please send M-Print PRO file		

**Technical drawing / application**



**MF MultiCard**

**MF-W 9/5.2F**

**5.2 mm**

Terminal marker

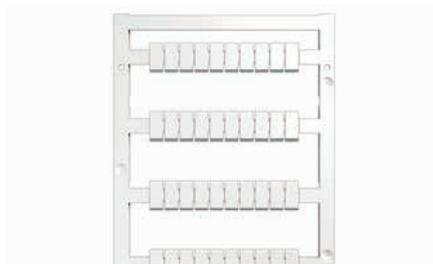

**Technical data**

Material	Polyamide 66
Fire class acc. to UL 94	V-2
Ambient temperature (operational)	-40 °C...100 °C
Application/manufacturer	WAGO, Legrand
Width	5.2 mm
Height	9 mm
<b>Note</b>	

Material	Polyamide 66
Fire class acc. to UL 94	V-2
Ambient temperature (operational)	-40 °C...100 °C
Application/manufacturer	WAGO, Legrand
Width	5.2 mm
Height	9 mm
<b>Note</b>	

**Ordering data**

<b>MultiCard Blank</b>	
white	○
<b>MultiCard custom printing</b>	
To customer specification	
<b>Note</b>	

Type	Qty.	Order No.
MF-W 9/5.2F MC NE WS	500	<b>1011410000</b>
MF-W 9/5.2F MC SDR	100	<b>1038760000</b>
Please send M-Print PRO file		

**Technical drawing / application**



**MF MultiCard – markers for use with other makes of terminals**

**MF MultiCard**

**MF-W 9/6**

**6 mm**

**MF-W 9/6.2F**

**6.2 mm**

Terminal marker



Terminal marker



**Technical data**

Material
Fire class acc. to UL 94
Ambient temperature (operational)
Application/manufacturer
Width
Height
<b>Note</b>

Polyamide 66
V-2
-40 °C...100 °C
WAGO, Legrand
6 mm
9 mm

Polyamide 66
V-2
-40 °C...100 °C
WAGO, Legrand
6.2 mm
9 mm

**Ordering data**

<b>MultiCard Blank</b>
white ○
<b>MultiCard custom printing</b>
To customer specification
<b>Note</b>

Type	Qty.	Order No.
MF-W 9/6 MC NE WS	500	<b>1816290000</b>
MF-W 9/6 MC SDR	100	<b>1816360000</b>
Please send M-Print PRO file		

Type	Qty.	Order No.
MF-W 9/6.2F MC NE WS	500	<b>1011420000</b>
MF-W 9/6.2F MC SDR	100	<b>1038770000</b>
Please send M-Print PRO file		

**Technical drawing / application**





**MF MultiCard**

**MF-W 5/5 Mini**

**5 mm**

Terminal marker



**Technical data**

Material	Polyamide 66
Fire class acc. to UL 94	V-2
Ambient temperature (operational)	-40 °C...100 °C
Application/manufacturer	WAGO, Legrand, Entelec
Width	5 mm
Height	5 mm
<b>Note</b>	

Material	Polyamide 66
Fire class acc. to UL 94	V-2
Ambient temperature (operational)	-40 °C...100 °C
Application/manufacturer	WAGO, Legrand, Entelec
Width	5 mm
Height	5 mm
<b>Note</b>	

**Ordering data**

<b>MultiCard Blank</b>	
blue	●
yellow	●
green	●
red	●
white	○
<b>MultiCard custom printing</b>	
To customer specification	
<b>Note</b>	

Type	Qty.	Order No.
MF-W 5/5 MINI MC NE BL	500	1924270000
MF-W 5/5 MINI MC NE GE	500	1924280000
MF-W 5/5 MINI MC NE GN	500	1924290000
MF-W 5/5 MINI MC NE RT	500	1924260000
MF-W 5/5 MINI MC NE WS	500	1816240000
MF-W 5/5 MINI MC SDR	100	1816310000
Please send M-Print PRO file		

**Technical drawing / application**



**MF MultiCard – markers for use with other makes of terminals**

**MF MultiCard**

**MF-WO 5/5**

**5 mm**

**MF-WO 9/5**

**5 mm**

Terminal marker



Terminal marker



**Technical data**

Material
Fire class acc. to UL 94
Ambient temperature (operational)
Application/manufacturer
Width
Height
<b>Note</b>

Polyamide 66
V-2
-40 °C...100 °C
Woertz
5 mm
5 mm

Polyamide 66
V-2
-40 °C...100 °C
Woertz
5 mm
9 mm

**Ordering data**

<b>MultiCard Blank</b>
white ○
<b>MultiCard custom printing</b>
To customer specification
<b>Note</b>

Type	Qty.	Order No.
MF-WO 5/5 MC NE WS	400	<b>1716800000</b>
MF-WO 5/5 MC SDR	80	<b>1716810000</b>
Please send M-Print PRO file		

Type	Qty.	Order No.
MF-WO 9/5 MC NE WS	400	<b>1716840000</b>
MF-WO 9/5 MC SDR	80	<b>1716850000</b>
Please send M-Print PRO file		

**Technical drawing / application**



**MF MultiCard**

**MF-WO 12/5**

**5 mm**

**MF-WO 9/6**

**6 mm**

Terminal marker



Terminal marker



**Technical data**

Material
Fire class acc. to UL 94
Ambient temperature (operational)
Application/manufacturer
Width
Height
<b>Note</b>

Polyamide 66
V-2
-40 °C...100 °C
Woertz
5 mm
12 mm

Polyamide 66
V-2
-40 °C...100 °C
Woertz
6 mm
9 mm

**Ordering data**

<b>MultiCard Blank</b>
white ○
<b>MultiCard custom printing</b>
To customer specification
<b>Note</b>

Type	Qty.	Order No.
MF-WO 12/5 MC NE WS	400	<b>1692270000</b>
MF-WO 12/5 MC SDR	80	<b>1692280000</b>
Please send M-Print PRO file		

Type	Qty.	Order No.
MF-WO 9/6 MC NE WS	400	<b>1716820000</b>
MF-WO 9/6 MC SDR	80	<b>1716830000</b>
Please send M-Print PRO file		

**Technical drawing / application**



**MF MultiCard – markers for use with other makes of terminals**

**MF MultiCard**

**MF-WO 12/6**

**6 mm**

Terminal marker



**Technical data**

Material
Fire class acc. to UL 94
Ambient temperature (operational)
Application/manufacturer
Width
Height
<b>Note</b>

Polyamide 66
V-2
-40 °C...100 °C
Woertz
6 mm
12 mm

**Ordering data**

<b>MultiCard Blank</b>
white <input type="radio"/>
<b>MultiCard custom printing</b>
To customer specification
<b>Note</b>

Type	Qty.	Order No.
MF-WO 12/6 MC NE WS	400	<b>1692290000</b>
MF-WO 12/6 MC SDR	80	<b>1692300000</b>
Please send M-Print PRO file		

**Technical drawing / application**



**MF MultiCard**

**MF-SI 8/5**

**5 mm**

**MF-SI 10/5**

**5 mm**

Terminal marker

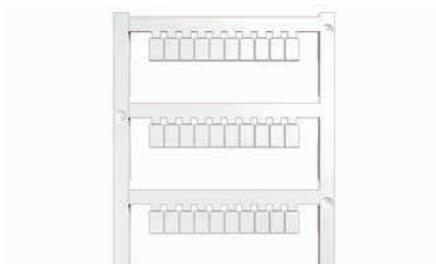

Terminal marker



**Technical data**

Material
Fire class acc. to UL 94
Ambient temperature (operational)
Application/manufacturer
Width
Height
<b>Note</b>

Polyamide 66
V-2
-40 °C...100 °C
Siemens
5 mm
8 mm

Polyamide 66
V-2
-40 °C...100 °C
Siemens
5 mm
10 mm

**Ordering data**

<b>MultiCard Blank</b>
white <span style="float: right;">○</span>
<b>MultiCard custom printing</b>
To customer specification
<b>Note</b>

Type	Qty.	Order No.
MF-SI 8/5 MC NE WS	400	<b>1889180000</b>
MF-SI 8/5 MC SDR	80	<b>1886270000</b>
Please send M-Print PRO file		

Type	Qty.	Order No.
MF-SI 10/5 MC NE WS	400	<b>1889190000</b>
MF-SI 10/5 MC SDR	80	<b>1889170000</b>
Please send M-Print PRO file		

**Technical drawing / application**



**MF MultiCard – markers for use with other makes of terminals**

**MF MultiCard**

**MF-SI 8/6**

**6 mm**

**MF-SI 10/6**

**6 mm**

Terminal marker



Terminal marker



**Technical data**

Material
Fire class acc. to UL 94
Ambient temperature (operational)
Application/manufacturer
Width
Height
<b>Note</b>

Polyamide 66
V-2
-40 °C...100 °C
Siemens
6 mm
8 mm

Polyamide 66
V-2
-40 °C...100 °C
Siemens
6 mm
10 mm

**Ordering data**

<b>MultiCard Blank</b>
white ○
<b>MultiCard custom printing</b>
To customer specification
<b>Note</b>

Type	Qty.	Order No.
MF-SI 8/6 MC NE WS	320	<b>1889240000</b>
MF-SI 8/6 MC SDR	64	<b>1889230000</b>
Please send M-Print PRO file		

Type	Qty.	Order No.
MF-SI 10/6 MC NE WS	320	<b>1889260000</b>
MF-SI 10/6 MC SDR	64	<b>1889250000</b>
Please send M-Print PRO file		

**Technical drawing / application**



**MF MultiCard**

**MF-SI 10/5-6.5** **5 mm**

**MF-SI 7/5-6.5** **5 mm**

Terminal marker

Terminal marker

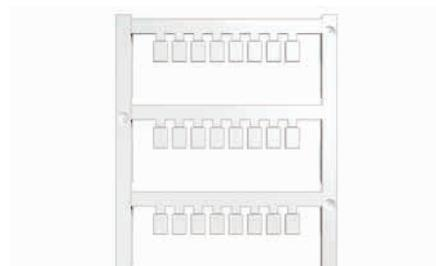

**Technical data**

Material
Fire class acc. to UL 94
Ambient temperature (operational)
Application/manufacturer
Width
Height
<b>Note</b>

Polyamide 66
V-2
-40 °C...100 °C
Siemens
5 mm
10 mm

Polyamide 66
V-2
-40 °C...100 °C
Siemens
5 mm
7 mm

**Ordering data**

<b>MultiCard Blank</b>
white <span style="float: right;">○</span>
<b>MultiCard custom printing</b>
To customer specification
<b>Note</b>

Type	Qty.	Order No.
MF-SI 10/5-6.5 MC NE WS	320	<b>1889800000</b>
MF-SI 10/5-6.5 MC SDR	64	<b>1889790000</b>
Please send M-Print PRO file		

Type	Qty.	Order No.
MF-SI 7/5-6.5 MC NE WS	320	<b>1889780000</b>
MF-SI 7/5-6.5 MC SDR	64	<b>1889770000</b>
Please send M-Print PRO file		

**Technical drawing / application**



**MF MultiCard – markers for use with other makes of terminals**

**MF MultiCard**

**MF-ABB 12/5**

**5 mm**

**MF-ABB 12/6**

**6 mm**

Terminal marker



Terminal marker



**Technical data**

Material
Fire class acc. to UL 94
Ambient temperature (operational)
Application/manufacturer
Width
Height
<b>Note</b>

Polyamide 66
V-2
-40 °C...100 °C
ABB SNK series
5 mm
12 mm

Polyamide 66
V-2
-40 °C...100 °C
ABB SNK series
6 mm
12 mm

**Ordering data**

<b>MultiCard Blank</b>
white ○
<b>MultiCard custom printing</b>
To customer specification
<b>Note</b>

Type	Qty.	Order No.
MF-ABB 12/5 MC NE WS	400	<b>2047320000</b>
MF-ABB 12/5 MC SDR	80	<b>2047460000</b>
Please send M-Print PRO file		

Type	Qty.	Order No.
MF-ABB 12/6 MC NE WS	400	<b>2047340000</b>
MF-ABB 12/6 MC SDR	80	<b>2047510000</b>
Please send M-Print PRO file		

**Technical drawing / application**





**MF MultiCard**

**MF-ABB 12/8**

**8 mm**

Terminal marker



**Technical data**

Material	Polyamide 66
Fire class acc. to UL 94	V-2
Ambient temperature (operational)	-40 °C...100 °C
Application/manufacturer	ABB SNK series
Width	8 mm
Height	12 mm
<b>Note</b>	

Material	Polyamide 66
Fire class acc. to UL 94	V-2
Ambient temperature (operational)	-40 °C...100 °C
Application/manufacturer	ABB SNK series
Width	8 mm
Height	12 mm
<b>Note</b>	

**Ordering data**

<b>MultiCard Blank</b>	
white	○
<b>MultiCard custom printing</b>	
To customer specification	
<b>Note</b>	

Type	Qty.	Order No.
MF-ABB 12/8 MC NE WS	280	<b>2047350000</b>
MF-ABB 12/8 MC SDR	56	<b>2047520000</b>
Please send M-Print PRO file		

**Technical drawing / application**



**Cross-reference table**

**Phoenix**

	MF 5/3.5	MF 5/4	MF 5/5	MF 8/5	MF 10/5	MF 12/5	MF 5/6	MF 10/6	MF 10/8	MF 5/10	MF 10/10	MF 5/7.5	MF 4/5.2	MF 5/12
AKG 16...								X						
AKG 35...								X						
AKG 4				X	X	X								
DFK 4...								X						
DFK 5...								X						
DIK 1.5...							X	X						
DIKD 1.5...							X	X						
DLK 2.5...							X	X						
DOK 1.5...							X	X						
DT 6/2.5-DREH...											X			
DTI 2.5 ...			X	X	X									
DTI 4 ...							X	X						
DTI 6 ...									X					
DTME 6 ...									X					
DTN 2.5 ...			X	X	X									
DTN 4 ...							X	X						
DTN 6 ...									X					
ECE...			X											
GE 10...											X			
GE 35...											X			
GTF 76/...											X			
HDFK 10									X					
HDFK 16											X			
HDFK 25											X			
HDFK 4								X						
HDFK 50/...														X
HDFK 95														X
HV M5/...											X			
HV M6/...											X			
HV M8/...											X			
HV M10/...											X			
HV M12/...											X			
IL...							X							
IB...							X							
MKB ...													X	
MBK 2.5/E...													X	
MBK 3...													X	
MBK 3/E-Z...			X	X	X	X								
MBK 5...													X	
MBK 5/E...													X	
MBK 5/E-Z...							X	X						
MBK 6/E...									X					
MBKKB 2.5...			X	X	X	X								
MPT 1.5/S	x													
MPT 2.5			X											
MSB 2.5 ...			X											
MSDB 2.5 ...			X											
MSBV 2.5 ...			X											
MSDBV 2.5 ...			X											
MSLKG 2.5												X		
MSLKG 5												X		
MSLKG 6									X					
MT 1.5...		X												
MTK ...			X	X	X	X								
MTKD...											X			
MTTB 1.5...		X												
MZB 1.5...			X											
MZDB 1.5...			X											
MZFK 1.5...			X											
MZFKK 1.5 ...			X											
MZFKKB 1.5			X											
OTTA 2.5									X					
OTTA 25										X	X			
OTTA 6...									X					
PCVK 4-7.62 ...							X	X						
PP-H 1.5/S...	X													
PP-H 2.5/...			X											
PP-H 4/...							X							
PPC 1.5/S...	X													
PT 1.5/S...	X													
PT 2.5			X		X									

Individual mounting is required if the terminal pitch is larger than the marker.

	MF 5/3.5	MF 5/4	MF 5/5	MF 8/5	MF 10/5	MF 12/5	MF 5/6	MF 10/6	MF 10/8	MF 5/10	MF 10/10	MF 5/7.5	MF 4/5.2	MF 5/12
PT 4...							X	X						
PT 10...											X			
PTI 2.5			X		X									
PTI 4...							X	X						
PTIO...	X													
PTS 1.5/S...	X													
PTTB 1.5/S...	X													
PTTB 2.5			X		X									
PTTB 4...							X	X						
PTTBS 1.5/S	X													
PTTBS 2.5			X		X									
PTN 2.5			X		X									
PTN 4...							X	X						
PTS 2.5			X		X									
PTU 2.5			X		X									
PTU 4...							X	X						
MPT 2.5			X											
PTME(D) 4...							X	X						
PVB...								X						
QP 1.5...			X											
QTC 1.5 ...			X	X	X									
QTC 2.5 ...							X	X						
QTC 2.5-HE..I ...							X							
QTCS 1.5 ...			X	X	X									
QTCS 2.5 ...							X	X						
QTCU 1.5 ...			X	X	X									
QTCU 2.5 ...							X	X						
QTTCB 1.5 ...			X											
QTTCBS 1.5 ...			X											
RT 3...													X	
RT 5...													X	
RT 8...													X	
RTO 3...													X	
RTO 5...													X	
RTO 8...													X	
RV 8-TP ...								X						
RVS 10-TP...								X						
SC 2.5...			X											
SC 4...							X							
SGSK 6									X					
SP 2.5/...			X											
SP 2.5/...			X											
SP 4/...							X							
SLKK 5...							X	X						
SRDK 6									X					
SRTK 6									X					
SSL 2.5			X											
ST 1.5/S-QUATTRO	x													
ST 1.5...		X												
ST 2.5...			X	X										
ST 2.5-3...			X											
ST 2.5-PCB...			X											
ST 2.5-PE/./...			X											
ST 2.5-4...			X											
ST 4...							X							
ST 4-PE/...							X							
ST 4-HE..I...							X							
ST 4-FSI/C ...									X					
ST 4-PCB...							X							
ST 6 ...									X					
ST 10 ...											X			
ST 16 ...														X
ST 35 ...							X							
STI 10...										X				
STI 16...														X
STI 2.5...			X	X	X									
STI 2.5-PE/./...			X	X	X	X								
STI 2.5-L ...			X	X	X	X								
STI 4...							X	X						
STIO 2.5/3...			X											
STIO-IN 2.5/3...			X											

Phoenix

	MF 5/3.5	MF 5/4	MF 5/5	MF 8/5	MF 10/5	MF 12/5	MF 5/6	MF 10/6	MF 10/8	MF 5/10	MF 10/10	MF 5/7.5	MF 4/5.2	MF 5/12
STIO 2.5/4...							X							
STIO-IN 2.5/4...							X							
STME .. 6 ...								X						
STN 10											X			
STN 16							X							
STN 2.5			X											
STN 35											X			
STN 4							X							
STS 2.5...			X	X	X	X								
STS 4...							X	X						
STS 6...									X					
STTB 1.5...		X												
STTB 2.5...			X											
STTB 4...							X							
STTBS 2.5 ...			X	X	X									
STTBS 4...							X	X						
STU 2.5-TWIN ...			X	X										
STU 4-TWIN ...							X							
STU 10/ ...							X							
STU 35/ ...							X							
STTBU 4 ...							X							
TCP...			X											
TMC...								X						
TMCP-CONNECT-LR								X						
TMCP-SOCKET-M								X						
TRK 4 (Raster 7.5)											X			
TT-STTB...								X						
UDK 3...			X	X	X	X								
UDK 4...							X	X						
UDK 4-MTK							X	X						
UDK 5-MTK							X	X						
UDMTK 5...							X	X						
UGSK 6									X					
UGSK/S									X					
UHK 4-FS...							X	X						
UHV 25 - UHV 240										X	X			
UIK 16...											X			X
UIK 35...											X			X
UISLKG 16...										X	X			
UISLKG 35...										X	X			
UK 10 N											X			
UK 10.3... HESI...											X			
UK 10-DRHESI...								X						
UK 16 N											X			
UK 2.5 N			X	X	X	X								
UK 3 N			X	X	X	X								
UK 35											X			
UK 35 N...											X			
UK 4...							X	X						
UK 5 N							X	X						
UK 5-HESI									X					
UK 5-MTK...							X	X						
UK 6 N									X					
UK 6.3-HESI											X			
UK 6-FSI/C...									X					
UKB 4 ...								X						
UKH 150 ...											X			
UKH 240 ...											X			
UKH 50 ...											X			
UKH 95 ...											X			
UKK 3...			X	X	X	X								
UKK 4-FS...							X	X						
UKK 5...							X	X						
UKKB 3...			X	X	X	X								
UKKB 5...							X	X						
UKKB 10											X			
UKKB 10/2.5			X	X	X	X					X			
UKN 10 N...											X			
UKN 16 N...											X			
UKN 2.5...							X	X						
UKN 35...											X			

Individual mounting is required if the terminal pitch is larger than the marker.

	MF 5/3.5	MF 5/4	MF 5/5	MF 8/5	MF 10/5	MF 12/5	MF 5/6	MF 10/6	MF 10/8	MF 5/10	MF 10/10	MF 5/7.5	MF 4/5.2	MF 5/12
UKN 5...							X	X						
UKN 6 N...									X					
UK-SI									X					
URDK 6									X					
URKN											X			
URKN/S									X					
URTK 6									X					
URTK/S									X					
URTK/S-BEN ...									X					
URTK/SP									X					
URTK/SS							X	X						
URTKD/SP									X					
UP 4/...							X							
UPBV 2.5/...				X										
UPBV 4/...							X							
UPCV3K ...							X	X						
USED 16											X			
USED 27											X			
USEN 14											X			
USEN 18											X			
USIG...											X			
USK 4-FS...							X	X						
USKLG 1.5 N		X												
USKLG 10 N...											X			
USKLG 16 N...											X			
USKLG 2.5 N...			X	X	X	X								
USKLG 3...			X	X	X	X								
USKLG 35											X			
USLKG 35 N											X			
USKLG 5...							X	X						
USKLG 50											X			
USKLG 6 N...									X					
USKLG 95											X			
UT 10 ...											X			
UT 16 ...											X			
UT 35 ...											X			
UT 2.5 ...				X	X	X								
UT 4 ...								X						
UT 4-HEDI ...							X	X						
UT 4-HESI ...							X	X						
UT 4-PE/...							X	X						
UTME .. 6 ...									X					
UTTB 2.5...			X	X	X	X								
UTTB 4...							X	X						
UT 6 ...									X					
UT 6-TMC M...											X			
UTI 16 ...											X			
UTI 35 ...											X			
UTN 2.5			X	X	X	X								
UTN 4							X	X						
UTN 6									X					
UTN 10											X			
UTN 16											X			
UTN 35											X			
UVKB 4-FS...							X	X						
VBSN 4								X						
VBST 4-FS...							X	X						
VKK 4-FS							X	X						
VIOK 1.5...							X	X						
W 80/...								X						
ZDIK 1.5...			X											
ZDMTK 2.5...							X							
ZFK 6-DREHSL...							X							
ZFKK 2.5-MT...			X											
ZGSK 4									X					
ZPV 1.5/2.5			X	X	X	X					X			
ZRTK 4											X			
ZRV 8							X	X						
ZVIOK 1.5...			X											

**Cross-reference table**

**WAGO**

	MF-W 9/4	MF-W 5/5 mini	MF-W 9/5	MF-W 9/5 F	MF-W 9/6
<b>Feed-through terminals</b>					
264-701/704/706		X			
264-711/714/716		X			
264-721/724/726		X			
264-731/734/736		X			
264-120/125/220/225		X			
279-101/104	X				
279-604/621	X				
279-626/826	X				
279-681...686	X				
279-831...836	X				
279-901...906	X				
279-989...995	X				
280-101/104	X				
280-601/602		X	X	X	
280-603/633/634		X	X	X	
280-604/621/826/626		X	X	X	
280-641/651/654		X	X	X	
280-646/656/946		X	X	X	
280-653/671/672		X	X	X	
280-681/684/650		X	X	X	
280-830...835		X	X	X	
280-901...906		X	X	X	
280-989...995		X	X	X	
280-996...999		X	X	X	
280-691		X	X	X	
281-101/104					X
281-601/604					X
281-631/651					X
281-652...654					X
281-663/664/668					X
281-678/681/684					X
281-901/902/904					X
281-992...994/998/691					X
282-101/104					X
282-601/604					X
282-681/682/684					X
282-901/902/904					X
282-992/993/691					X
283-101/104					X
283-601/604					X
283-671/672/674					X
283-901/902/904					X
283-992/998/691					X
284-101/104					X
284-601/604					X
284-621/624					X
284-681/682/684					X
284-691/992/993					X
284-901/902/904					X
285-194/195					X
285-601/604/607					X
285-634/635		X			X
285-691					X
285-992/995					X
290-861/864/867		X	X	X	
780-601/602/604			X	X	
780-631/651/654			X	X	
780-992/993			X	X	
781-601/604					X
781-631/651					X
781-992/993					X
782-601/604					X
782-992					X
783-601/604					X
783-992					X
784-601/604					X
784-992					X
785-601/604/613					X
792... all		X			
812-140			X	X	X
<b>Protective earth terminals</b>					
264-727		X			
264-737		X			
279-687	X				
279-837	X				
279-907	X				
280-107		X	X	X	
280-607		X	X	X	
280-637		X	X	X	
280-677		X	X	X	
280-687		X	X	X	
280-837		X	X	X	
280-907		X	X	X	
281-107					X
281-607					X
281-637					X
281-657					X
281-687					X
281-907					X
282-107					X
282-607					X
282-687					X
282-907					X
283-607					X
283-609					X
283-677					X
283-907					X
284-107					X
284-607					X
284-687					X
284-907					X
285-197					X
285-607		X			X
285-637		X			X
780-607			X	X	
780-637			X	X	
780-637					X
781-607					X
782-607					X
783-607					X
784-607					X
785-607					X
870-687		X		X	
870-837		X		X	
870-907		X		X	
870-917		X		X	
880-687		X	X	X	
880-837		X	X	X	
880-907		X	X	X	
<b>Fuse terminals</b>					
282-698					X
282-696					X
281-611/612/616/622					X
281-624/672					X
281-613/623					X
282-122					X
282-120					X
282-126					X
282-124					X
282-128					X
<b>Two-tier terminals</b>					
279-501/512/513	X				
279-504	X				
279-507	X				
279-508	X				
279-509	X				
279-517/527	X				
280-513		X	X	X	
280-517		X	X	X	
280-519/529		X	X	X	
280-520/530		X	X	X	
280-521/525		X	X	X	
280-522/526		X	X	X	
280-523/533		X	X	X	
280-524/534		X	X	X	
280-527/537		X	X	X	
280-531		X	X	X	
280-532		X	X	X	
280-543		X	X	X	
281-619/629					X
281-620/630					X
870-101...104		X	X	X	
870-107		X	X	X	
870-108		X	X	X	
870-117/127		X	X	X	
870-501...504		X	X	X	
870-507		X	X	X	
870-508/509		X	X	X	
870-517/527		X	X	X	
870-531...534		X	X	X	
870-535/536		X	X	X	
870-537		X	X	X	
870-538/538		X	X	X	
870-826		X	X	X	
<b>Three- and four-tier terminals</b>					
280-549/551		X	X	X	
280-550		X	X	X	
280-552		X	X	X	
280-547/557/597		X	X	X	
280-548/558		X	X	X	
281-531/532					X
870-551/553		X		X	
870-556		X		X	
870-558/559/567/577		X		X	
870-557		X		X	
281-530					X
<b>Routing and potential terminals</b>					
727... all					X
280-675			X		
<b>Honeycomb elements</b>					
726... all			X		
<b>Single terminals</b>					
264-130/131		X			
264-230/231		X			
264-180/280		X			
<b>Pluggable relays and bases</b>					
286... all	X				
786... all	X				
788... all			X		X
789... all		X			
<b>Multi-tier terminals</b>					
775-641			X	X	
775-642/649			X	X	
775-646			X	X	
775-645			X	X	

The markers must be mounted individually when the terminal pitch is larger than 6.2 mm.



Cross-reference table

ABB-Stotz/Entelec

	MF-W 9/4	MF-W 9/5	MF-W 9/5 F	MF-W 9/6	MF-W 9/6.2 F	MF-W 5/5 mini	MF 10/5	MF 10/6	MF 10/8	MF 10/10	MF-ABB 12/5	MF-ABB 12/6	MF-ABB 12/8
131 ET TM4...						X							
165 LT TM5...						X							
41 H LT...						X							
62 H...				X									
BADH				X									
BADL				X	X			X					
BADRL				X	X	X		X					
BAEH				X									
BAM...				X	X			X					
BAMH				X	X			X					
D 1.5/4...	X												
D 1.5/6...				X									
D 1.5/6...ADO...				X									
D 1.5/8...ADO				X									
D 1/5...ADO		X											
D 10/10...						X							
D 150/31...				X	X								
D 16/12...						X							
D 2.5/5 P...		X	X										
D 2.5/5...						X							
D 2.5/5...ADO		X											
D 2.5/6...						X							
D 2.5/8...						X							
D 2.5/8...ADO...				X									
D 240/36...				X	X								
D 35/16...						X							
D 4/6 P...				X	X			X					
D 4/6...						X							
D 4/6...ADO		X											
D 4/6...ADO				X									
D 4/8...				X									
D 4/8...ADO...				X									
D 6/10...				X	X			X	X	X			
D 6/8 P...				X	X				X				
D 6/8 ST...				X	X				X				
D 6/8...						X							
D 6/8...ADO...				X									
D 70/22...				X	X								
DB 1.5/6...						X							
DB 1/5...						X							
DB 2.5/5...						X							
DB 2.5/8...						X							
DB 4/6...						X							
DB 4/8...						X							
DF 6				X				X					
DH 1.5/6...						X							
DH 1/5...						X							
DH 2.5/5...						X							
DH 2.5/8...						X							
DH 4/6...						X							
DH 4/8...						X							
DL 10/17.5...						X							
DR 1.5/4...	X												
DR 1.5/5...						X							
DR 1.5/6...						X							
DR 1/5...						X							
DR 2.5/10...						X							
DR 2.5/5...						X							
DR 2.5/8...						X							
DR 4/6...						X							

Individual mounting is required if the terminal pitch is larger than the marker.

	MF-W 9/4	MF-W 9/5	MF-W 9/5 F	MF-W 9/6	MF-W 9/6.2 F	MF-W 5/5 mini	MF 10/5	MF 10/6	MF 10/8	MF 10/10	MF-ABB 12/5	MF-ABB 12/6	MF-ABB 12/8
DR 4/8...				X	X				X				
DR 4/8...ADO...						X							
DS 1.5/6...						X							
DS 1/5...						X							
DS 2.5/5...						X							
DS 2.5/8...						X							
DS 4/6...						X							
DS 4/8...						X							
HD 10/12...		X											
HD 120/30...		X											
HD 16/14...		X											
HD 185/36...		X											
HD 2.5/6...				X									
HD 35/16...		X											
HD 4/9...		X											
HD 6/14...				X									
HD 6/8...				X									
HD 6/9...				X									
HD 70/22...		X											
M 1.5/6...				X				X					
M 10/10...			X	X						X			
M 10/16...			X	X				X	X	X			
M 16/12.PEN				X									
M 16/12...				X	X			X	X	X			
M 2.5/6.5...						X							
M 2.5/6...						X							
M 35/16...				X	X			X	X	X			
M 4/6...				X				X					
M 4/6...AP...				X									
M 4/7...				X	X			X					
M 4/8...				X	X				X				
M 6/12...				X									
M 6/13...				X									
M 6/8...				X	X				X				
M 70/22...				X	X			X	X	X			
M 95/26...				X	X			X	X	X			
MA 2.5/5...		X	X			X							
MB 10/10...				X	X					X			
MB 10/12 SF...				X									
MB 10/22...		X											
MB 10/24...		X						X	X	X			
MB 25/30...				X	X			X	X	X			
MB 4/6...				X				X					
MB 6/8...				X	X				X				
MB 70/10...				X	X					X			
ML 10/13...				X	X					X			
MS 4/6...				X	X			X					
MS 6/8...				X	X				X				
MTC 6				X				X					
MU 10/13...				X	X					X			
MU 10/14.5...				X	X					X			
T 1.5/6...				X		X							
T 2.5/5...		X											
T 2.5/6...				X									
T 4/6...				X									
SNK Series											X	X	X
ZK											X	X	X
ZS4...											X		
ZS6...												X	
ZS8...													X

## Wieland

	MF 8/5	MF 10/5	MF 12/5	MF 10/6
9700 A/5...	X	X	X	
9700 A/6...				X
9700 A/8...				X
9700 A/10...				X
9700 A/12...			X	
9700 A/16...				X
9700 B...				X
9701 A/6...A/16				X
9708/2 ...			X	
9760 U...				X
9785 U...				X
9786 U...				X
AKB...	X	X	X	
AKT...	X	X	X	
flare Move ... (6.2 mm)				X
Terminal adapter revos Basic	X	X	X	
Terminal adapter revos HD	X	X	X	
Terminal adapter revos Power	X	X	X	
RV2../...	X	X	X	
UET...	X	X	X	
WEB...	X	X	X	
WEF 1...				X
WEG...	X	X	X	
WK 2.5...	X	X	X	
WK 2.5-4 KI...	X	X	X	
WK 2.5-4 KOI...	X	X	X	
WK 2.5-3 D...	X	X	X	
WK 2.5 U/D...	X	X	X	
WK 4...				X
WK 4 D...				X
WK 4 E...				X
WK 4/SH-D...				X
WK 4 TK...				X
WK 4 THSI ...				X
WK 6...				X
WK 10/SI...				X
WKC 1 ...	X	X		
WKC 2.5 ...				X
WKC 1 TKG...	X	X		
WKC 2.5 TKG...				X
WKN 10...				X
WKN 16...				X
WKN 2.5 E...	X	X	X	
WKN 35...				X
WKN 4 ...				X
WKN 70...				X
WK/3-6...				X
WK/4-8...				X
WKB 2.5...	X	X	X	
WKF 1.5 E...	X	X	X	
WKF 1.5 KOI...	X	X	X	
WKF 10...				X
WKF 16...				X
WKF 35...				X
WKF 2.5...	X	X	X	
WKF 2.5 D...	X	X	X	
WKF 2.5/M...	X	X	X	
WKF 4...				X
WKF 4 TK...				X
WKF 6...				X
WKFN 2.5...	X	X	X	
WKFN 2.5 E...	X	X	X	
WKFN 4...				X
WKFN 4 E...				X
WKI 10...				X
WKI 16...				X
WKI 35...				X
WKI 4...				X
WKIF 2.5 ...	X	X	X	
WKM 2.5...	X	X	X	
WKMF 2.5../1.5	X	X	X	
WKM 4...				X

Individual mounting is required if the terminal pitch is larger than the marker.

## Cabur

	MF 10/5 Cabur	MF 12/5 Cabur
AFO.2...	X	X
CAM...	X	X
CBC.2... - CBC.35...	X	X
CBD.2... - CBD.70...	X	X
CBE.2...	X	
CBR.2...	X	X
CNT.16...	X	X
CNT.35...	X	X
CNT.6...	X	X
CVF.4...	X	X
DAS.4...	X	X
DBC.2...	X	
DSFA.4	X	
DSS.4...	X	
FDP.2...	X	X
FFS.4...	X	X
FPC.10...	X	X
FPL.10...	X	X
FVS.4...	X	X
MAC.6...	X	X
MPFA.4...	X	
MPS.2...	X	X
MPS.4...	X	X
NCS...	X	X
NCV...	X	X
PDF.2...	X	X
RFI.2...	X	
RN.2...	X	
RP.4...	X	
SCB.4...	X	X
SCB.6...	X	X
SFO.4...	X	X
SFR.4...	X	X
SFR.6...	X	X
TC/PO...	X	X
TDE.2...	X	X
TE.10...	X	X
TE.16...	X	X
TE.50...	X	X
TE.6...	X	X
TEC.10...	X	X
TEC.16...	X	X
TEC.35...	X	X
TEC.6...	X	X
TEC.70...	X	X
TEO.4...	X	X
TEO.2...	X	X
TEO.4...	X	X
TLD.2...	X	X
TLE.2	X	X
TLS.2...	X	X
TR.2...	X	
TR.4...	X	X
VPC.2...	X	X

**Cross-reference table**

**Siemens**

	MF-SI 8/5	MF-SI 10/5	MF-SI 8/6	MF-SI 10/6	MF-SI 7/5-6.5	MF-SI 10/5-6.5	MF 5/4	MF 5/5	MF 8/5	MF 10/5	MF 12/5	MF 5/6	MF 10/6	MF 10/8	MF 10/10
8WA1 011-0DG...			X	X											
8WA1 011-1BF...	X	X													
8WA1 011-1BG...			X	X											
8WA1 011-1BH...			X	X											
8WA1 011-1BK...			X	X											
8WA1 011-1BM...			X	X											
8WA1 011-1BP...			X	X											
8WA1 011-1DF...	X	X													
8WA1 011-1DG...			X	X											
8WA1 011-1DH...			X	X											
8WA1 011-1EE...			X	X											
8WA1 011-1EF...	X	X													
8WA1 011-1MH...			X	X											
8WA1 011-1NF...	X	X													
8WA1 011-1NG...			X	X											
8WA1 011-1NH...			X	X											
8WA1 011-1PF...	X	X													
8WA1 011-1PG...			X	X											
8WA1 011-1PH...			X	X											
8WA1 011-1PK...			X	X											
8WA1 011-1PM...			X	X											
8WA1 011-1SF...			X	X											
8WA1 011-2BG11					X	X									
8WA1 011-2DG11					X	X									
8WA1 011-3DF...	X	X													
8WA1 011-3DG...			X	X											
8WA1 011-3DH...			X	X											
8WA1 011-3JF...	X	X													
8WA1 011-6BG11					X	X									
8WA1 011-6DG11					X	X									
8WA1 011-6EG...					X	X									
8WA1 204			X	X											
8WA1 205			X	X											
8WA1 206			X	X											
8WA1 221	X	X													
8WA1 232			X	X											
8WA1 304			X	X											
8WA1 305			X	X											
8WA1 501	X	X													
8WA1 604			X	X											
8WA2 011...NK23			X	X											
8WA2 011-1BF...	X	X													
8WA2 011-1BG...			X	X											
8WA2 011-1BH...			X	X											
8WA2 011-1BJ...			X	X											
8WA2 011-1BK...			X	X											
8WA2 011-1DF...	X	X													
8WA2 011-1DG...			X	X											
8WA2 011-1DH...			X	X											
8WA2 011-1DJ...			X	X											
8WA2 011-1DK...			X	X											
8WA2 011-1EF20	X	X													
8WA2 011-1LF20	X	X													
8WA2 011-1NG23			X	X											
8WA2 011-1NH23			X	X											
8WA2 011-1PF...	X	X													
8WA2 011-1PG...			X	X											
8WA2 011-1PH...			X	X											
8WA2 011-1PJ...			X	X											
8WA2 011-1PK...			X	X											
8WA2 011-1SG...			X	X											
8WA2 011-2BG...			X	X											
8WA2 011-2DG...			X	X											
8WA2 011-3JG...			X	X											
8WA2 011-3JH23			X	X											
8WA2 011-3KE	X	X													
8WA2 011-6EG...			X	X											
8WA9 200			X	X											
8WH1 000-0AN...					X	X									
8WH1 000-0AQ...					X	X									
8WH1 000-0AS...					X	X									
8WH1 000-0AU...					X	X									
8WH1 000-0CN...					X	X									
8WH1 000-0CC...					X	X									
8WH1 001-0...K...															X
8WH1 001-0...M...															X
8WH1 001-0BJ...															X
8WH1 001-0BJ...															X

Individual mounting is required if the terminal pitch is larger than the marker.



Siemens

	MF-SI 8/5	MF-SI 10/5	MF-SI 8/6	MF-SI 10/6	MF-SI 7/5-6.5	MF-SI 10/5-6.5	MF 5/4	MF 5/5	MF 8/5	MF 10/5	MF 12/5	MF 5/6	MF 10/6	MF 10/8	MF 10/10
8WH1 001-0BJ...															X
8WH1 060-0A...00					X	X									
8WH1 070-0A...					X	X									
8WH2 ...6AF...								X	X	X					
8WH2 ...6AG...												X	X		
8WH2 ...6CF...								X	X	X					
8WH2 ...6CG...												X	X		
8WH2 00...0AE...							X								
8WH2 00...0AF...								X	X	X					
8WH2 00...0AG...												X	X		
8WH2 00...0CE...							X								
8WH2 00...0CF...								X	X	X					
8WH2 00...0CG...												X	X		
8WH2 00...0AH...															X
8WH2 00...0AJ...															X
8WH2 00...0AK...															X
8WH2 00...0AM...															X
8WH2 00...0CH...															X
8WH2 000-1AG...															X
8WH2 000-1BG...															X
8WH2 000-1GG...												X	X		
8WH2 000-1HG...															X
8WH2 000-1JG...												X	X		
8WH2 000-1MG...												X	X		
8WH2 000-1NG...															X
8WH2 000-1RG...															X
8WH2 003-5...F...								X	X						
8WH2 02...0AE...							X								
8WH2 02...0AF...								X	X						
8WH2 02...0AG...												X	X		
8WH2 02...0CE...							X								
8WH2 02...0CF...								X	X						
8WH2 02...0CG...												X	X		
8WH2 02...4...F...								X	X						
8WH2 020-5...F...								X	X						
8WH2 03...0...F...								X	X						
8WH2 04...0...F...								X	X						
8WH2 040-4L...								X	X						
8WH2 103...BF...								X	X	X					
8WH2 103...BG...												X	X		
8WH2 50...0...F...								X	X						
8WH2 50...0...G...												X	X		
8WH2 50...0...H...															X
8WH2 50...6...F...								X	X						
8WH2 520-0...F...								X	X						
8WH2 520-0...G...												X	X		
8WH3 00...0...E...								X	X	X					
8WH3 00...0...F...												X	X		
8WH3 000-6AE...								X	X	X					
8WH3 000-6AF...												X	X		
8WH3 000-6CF...												X	X		
8WH3 020...E...								X							
8WH3 1...2...E...								X	X	X					
8WH3 1...2...F...												X	X		
8WH3 1...3...E...								X	X	X					
8WH3 1...3...F...												X	X		
8WH4 00...0...F...								X	X	X					
8WH4 00...0...G...												X	X		
8WH4 00...0...H...															X
8WH4 001...F...									X	X					
8WH5 00...0...F...								X	X	X					
8WH5 10...F...								X	X	X					
8WH5 100...KG...												X	X		
8WH5 103-6...F...								X	X	X					
8WH5 12...MF...								X							
8WH9 040-1AB...								X							
8WH9 040-1BB...								X							
8WH9 040-1CB...								X							
8WH9 040-1DB...								X							
8WH9 040-1EB...								X							
8WH9 040-1FB...								X							
8WH9 050-0AB...															
8WH9 050-0LB...								X							
8WH9 050-1KB...												X			
8WH9 050-1LB...												X			
8WH9 050-1MB...												X			
8WH9 150-0CA00					X	X									

Individual mounting is required if the terminal pitch is larger than the marker.

Beckhoff

	MF-W 5/5 mini	ESG 8/11	MF 5/10
I/O modules	X	X	X

Adels

	MF 5/7.5
RKV Transformer terminal	X

**Cross-reference table**

**Allen-Bradley**

	MF-WO 5/5	MF-WO 9/5	MF-WO 12/5	MF-WO 9/6	MF-WO 12/6	DEK 5/3.5	DEK 5/5	DEK 5/6	DEK 5/8	WS 12/3.5	WS 8/5	WS 10/5	WS 10/5 m.	WS 12/5	WS 15/5	WS 10/6	WS 10/6 m.	WS 12/6	WS 12/6.5	WS 12/6.5	ZS 10/5	ZS 12/6	ZS 15/5	
1492-J10...							X																	
1492-J16...							X																	
1492-J20...							X							X										
1492-J3...							X							X										
1492-J35...							X							X										
1492-J3F...							X							X										
1492-J3P...							X							X										
1492-J3PTP...							X							X										
1492-J3TW...							X							X										
1492-J4...								X										X						
1492-J4M...								X										X						
1492-J50...							X																	
1492-J6...									X															
1492-J70...							X																	
1492-JC3...							X							X										
1492-JD3...							X				X													
1492-JD3C...							X				X													
1492-JD3DF...							X				X													
1492-JD3DR...							X				X													
1492-JD3F...							X				X													
1492-JD3P...							X						X											
1492-JD3PSS...							X						X											
1492-JD3PSSTP							X						X											
1492-JD3PTP...							X						X											
1492-JD3RB...							X				X													
1492-JD3RC001							X				X													
1492-JD3SS...							X				X													
1492-JDC3...							X							X										
1492-JDG3...							X				X													
1492-JDG3C...							X				X													
1492-JDG3P...							X						X											
1492-JDG3PSS...							X						X											
1492-JDG3PSSTP							X						X											
1492-JDG3PTP...							X						X											
1492-JG10...									X															
1492-JG16...									X															
1492-JG20...							X							X										
1492-JG3...							X							X										
1492-JG35...									X															
1492-JG3TW...							X							X										
1492-JG4...								X																
1492-JG50...									X															
1492-JG6...									X															
1492-JG70...									X															
1492-JKD3...							X							X										
1492-JKD3TP...							X							X										
1492-JPO...								X																
1492-JTC3...							X							X										
1492-K2...													X											
1492-K3...																								
1492-KG2...													X											
1492-KG3...																								
1492-KW2...													X											
1492-KW3...																								
1492-L10...									X															X
1492-L16...									X															X
1492-L16D...									X															X
1492-L2...							X			X														
1492-L20...							X			X														
1492-L2T...							X			X														
1492-L3...								X				X												
1492-L35...									X															
1492-L3P...								X				X												X
1492-L3Q...								X				X												
1492-L3QS...								X				X												
1492-L3T...								X				X												
1492-L4...									X															X
1492-L40...									X															X
1492-L4T...									X															X
1492-L6...									X															X
1492-L6T...									X															X
1492-LC3...								X				X												
1492-LD2...							X																	
1492-LD2C...							X																	
1492-LD3...								X				X												
1492-LD3C...								X				X												
1492-LD4...									X															
1492-LD4C...									X															

Individual mounting is required if the terminal pitch is larger than the marker.

Allen-Bradley

	MF-WO 5/5	MF-WO 9/5	MF-WO 12/5	MF-WO 9/6	MF-WO 12/6	DEK 5/3.5	DEK 5/5	DEK 5/6	DEK 5/8	WS 12/3.5	WS 8/5	WS 10/5	WS 10/5 m.	WS 12/5	WS 15/5	WS 10/6	WS 10/6 m.	WS 12/6	WS 12/6.5	WS 12/6.5	ZS 10/5	ZS 12/6	ZS 15/5
1492-LD4DF...								X								X							
1492-LD4DR...								X								X							
1492-LD4RB...								X								X							
1492-LD4SS...								X								X							
1492-LDAG3...							X				X												
1492-LDC3...							X				X												
1492-LDG2...						X				X													
1492-LDG3...							X				X												
1492-LDG3P...							X				X												
1492-LDG4...								X								X							
1492-LG10...									X									X					X
1492-LG16...									X										X				X
1492-LG2...					X					X													
1492-LG3...							X					X										X	X
1492-LG35...								X												X			X
1492-LG4...								X								X						X	X
1492-LG6...									X									X				X	X
1492-LKD3...							X				X												
1492-LM3...							X				X										X		
1492-LM3Q...							X				X										X		
1492-LMG3...							X				X										X		
1492-LMJ3...							X						X								X		
1492-LMJG3...							X						X								X		
1492-LMP3...							X				X										X		
1492-LMP3Q...							X				X										X		
1492-LS...							X					X									X		
1492-LTF3...							X						X										
1492-W16S...					X																		
1492-W3...		X																					
1492-W4...					X																		
1492-W4TW...				X																			
1492-W6...					X																		
1492-WFB4		X		X	X																		
1492-WG10S...					X																		
1492-WG16S...					X																		
1492-WG4...					X																		
1492-WG6...					X																		
1492-WM3...	X																						
1492-WM4...				X																			
1492-WMD...	X																						
1492-WMG...				X																			
1492-WR3...		X																					
1492-WTF3...		X																					
1492-WTS3...		X																					

Telemecanique

	MF 8/5	MF 10/5	MF 12/5	MF 10/6		MF 8/5	MF 10/5	MF 12/5	MF 10/6	
AB1 AA135U...	X	X	X							
AB1 AA235U...				X						
AB1 AATP135U...	X	X	X							
AB1 AATP235U...				X						
AB1 AASC...				X						
AB1 AASF...				X						
AB1 AAET135UGR	X	X	X							
AB1 AAET235...				X						
AB1 RR235U...	X	X	X							
AB1 RR435U...				X						
AB1 RR635U2				X						
AB1 RR1035U2				X						
AB1 RR1635U2				X						
AB1 R RTP235U...	X	X	X							
AB1 R RTP435U...				X						
AB1 R RTP635U2				X						
AB1 R RTP1035U2				X						
AB1 R RTP1635U2				X						
AB1 RRSC435UGR				X						
AB1 RRSF435U				X						
AB1 RRET...	X	X	X							
AB1 VV235U	X	X	X							
AB1 VV435U										
AB1 VV635U										
AB1 VVN...										
AB1 TP...										
AB1 SC435U										
AB1 FUSE435U										
AB1 SF435U										
AB1 D11435U										
AB1 F...										
AB1 E...										
AB1 D...										
AB1 TR...										
AB1 NEN...										
AB1 BB...										
AB1 BC...										
AB1 VV215	X	X	X							
AB1 VV415										
AB1 TP215										
AB1 BV10235U										
AB1 DV10235U										
AB1 BCP20235U										

The markers must be mounted individually when the terminal pitch is larger than 6 mm.

**Cross-reference table**

**Woertz**

	MF-WO 5/5	MF-WO 9/5	MF-WO 12/5	MF-WO 9/6	MF-WO 12/6
2711...	X				
2759...	X				
2760...	X				
3410...					X
3424...					X
3426...					X
3427...					X
3428...					X
3429...					X
3430...				X	
3436/4...					X
3436...					X
3436/10...					X
3437...					X
3438...					X
3440...					X
3450...					X
3452...					X
3452/10...					X
3452/16...					X
3472...					X
3473...					X
3477...					X
30003...					X
30005...					X
30008...					X
30009...					X
30041...					X
30123...					X
30124...					X
30125...					X
30127...					X
30128...					X
30130...					X
30137...					X
30138...					X
30143...					X
30146...					X
30150...		X			
30168...					X
30172...					X
30176...					X
30191...					X
30195...					X
30197...					X
30200...					X
30228...					X
30290...					X
30291...					X
30400...	X				
30403...	X				
30430...				X	
30431...				X	
30432...				X	
30544/4...					X
30544/6...					X
30544/10...					X
30544/16...					X
30550...					X
30800...					X
30810...		X			
30840...					X
30841...					X
30842...					X
30843...					X
30844...					X
30860...		X			
30870...		X			
30880...		X			
30890...					X

**Legrand**

	MF 8/5	MF 10/5	MF 10/6
390 60	X	X	
390 61			X
390 62			X
390 64			X
390 66			X
390 68			X
390 70			X
390 77	X	X	
390 78			X
390 76			X
390 80			X
390 81			X
390 84			X
390 85			X
390 86			X
393 00	X	X	
393 01			X
393 02			X
393 03			X
393 04			X
393 05			X
393 07			X
393 60	X	X	
393 61			X
393 62			X
393 64			X
393 66			X
393 68			X
393 70			X
393 71	X	X	
393 72			X
393 73			X
393 74			X
393 76			X
393 78			X
393 81			X
393 82			X
394 00			X
394 02			X
396 01	X	X	
396 02	X	X	
396 03	X	X	
396 04			X
396 11	X	X	
396 12	X	X	
396 13	X	X	
396 14			X
396 21	X	X	
396 24			X
396 23	X	X	

**Festo**

	MFF 10/6	MFF 9/4	ESG 10/17	ESG 9/20	ESG-M 8/20	ESG-M 9/17
CPE	X					
MZBH	X					
MOZBH	X					
MEBH	X					
MOEBH	X					
JMN2H, MN2H						X
JMN2H, MN1H				X		
JMT2H/MT2H...4.0				X		
JMT2H, MT2H...7.0			X			
MVH, MOVH, MDH, MODH				X		
MHA1, MHP1		X				
CPV10/14	X					
CPV18				X		
CP-E16	X					
CP-A08	X					
MV-BZ Typ 02				X		
KMYZ	X					
Pneumatic elements and valve clusters					X	

**Murr**

	ESG-M 9/17	ESG-M 8/20	ESG 9/20	MF 10/5	MF 12/5
MASI	X				
MVP	X				
Cube67		X			
M8 distributor				X	
MVK		X			
Optocoupler					X
Miro-Series					X





# WAD MultiCard

## Intelligent solutions for expansive designations

### The large surface areas which come with a time-saving folding mechanism

The WAD marker is the preferred choice for marking group functions. Locket to individual terminals, or the end brackets, this marker gives you the largest possible surface for your labelling.



PrintJet CONNECT

C

### WAD – the benefits to you

- WAD marker and cover for the terminals of the W-series and end brackets WEW 35/2 and ZEW 35/2
- Optimised: large labelling surfaces give you the best overview
- Top-quality and resistant printing with PrintJet CONNECT printer



Signalling effect: WAD markers designed with PrintJet CONNECT are ideally suited for eye catching colour coding of terminal strips.



For warning notices: WAD markers are available with lightning bolt symbols in special or standard print.



### Technical data

Material	Polyamide 66, halogen-free
UL 94 flammability rating	V2
Temperature range	-40 °C to 100 °C

### Ordering data

Colour	International colour code colours, not contained in the range, are available on request.
Special printing	Specify special printing and colours per using the M-Print® PRO software.
Printing	Black or colour
Possible printing systems	PrintJet CONNECT, PrintJet ADVANCED
Minimum order quantity	1 pack = 5 cards



WAD MultiCard

WAD 5

5 mm

WAD 5 MC B

5 mm

Terminal marker



Terminal marker



Technical data

Material
Fire class acc. to UL 94
Ambient temperature (operational)
Width
Height
Note

Polyamide 66
V-2
-40 °C...100 °C
5 mm
33.3 mm

Polyamide 66
V-2
-40 °C...100 °C
5 mm
33.3 mm

Ordering data

<b>MultiCard Blank</b>	
yellow	●
white	○
<b>MultiCard custom printing</b>	
To customer specification	
Note	

Type	Qty.	Order No.
WAD 5 MC NE GE	48	1112920000
WAD 5 MC NE WS	48	1112910000
WAD 5 MC SDR	12	1112930000
Please send M-Print PRO file		

Type	Qty.	Order No.
WAD 5 MC B GE/SW	48	1120450000
Please send M-Print PRO file		

Technical drawing / application



**WAD MultiCard – connector markers for terminals and endbrackets**

**WAD MultiCard**

**WAD 8**

**8 mm**

Terminal marker



**WAD 8 MC B**

**8 mm**

Terminal marker

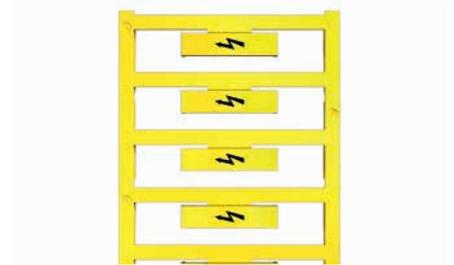

**Technical data**

Material
Fire class acc. to UL 94
Ambient temperature (operational)
Width
Height
<b>Note</b>

Polyamide 66
V-2
-40 °C...100 °C
8 mm
33.3 mm

Polyamide 66
V-2
-40 °C...100 °C
8 mm
33.3 mm

**Ordering data**

<b>MultiCard Blank</b>
yellow ●
white ○
<b>MultiCard custom printing</b>
To customer specification
<b>Note</b>

Type	Qty.	Order No.
WAD 8 MC NE GE	48	1112950000
WAD 8 MC NE WS	48	1112940000
WAD 8 MC SDR	12	1112970000
Please send M-Print PRO file		

Type	Qty.	Order No.
WAD 8 MC B GE/SW	48	1120470000
WAD 8 MC SDR	12	1112970000
Please send M-Print PRO file		

**Technical drawing / application**



WAD MultiCard

WAD 12

11.9 mm

WAD 12 MC B

11.9 mm



Technical data

Material
Fire class acc. to UL 94
Ambient temperature (operational)
Width
Height
Note

Polyamide 66
V-2
-40 °C...100 °C
11.9 mm
36.2 mm

Polyamide 66
V-2
-40 °C...100 °C
11.9 mm
36.2 mm

Ordering data

<b>MultiCard Blank</b>	
yellow	●
white	○
<b>MultiCard custom printing</b>	
To customer specification	
Note	

Type	Qty.	Order No.
WAD 12 MC NE GE	32	2445080000
WAD 12 MC NE WS	32	2445070000
<hr/>		
WAD 12 MC SDR	8	2445100000
Please send M-Print PRO file		

Type	Qty.	Order No.
WAD 12 MC B GE/SW	32	2445090000
<hr/>		
Please send M-Print PRO file		

Technical drawing / application



# ELS MultiCard

## Resilient, inlay tags

### A resilient interior for cable markers or tag carriers

Optimally designed for use in WKM cable markers or SchT 5-type tag carriers, the ELS tags meet the highest requirements where prominent identification of cables and terminal strips is needed. The high-quality markers are made of polyamide 66. This guarantees a constant, high-quality appearance and clear and simple presentation of information even in extreme conditions where oil, water or other fluids are present.

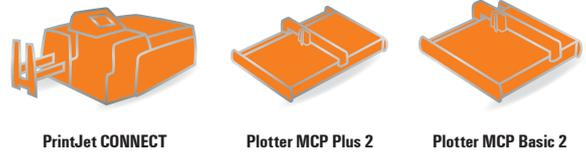

### ELS inlay tags – the benefits to you

- Perfectly fitting: in flat form they are the perfect inserts for WKM or SchT 5-type
- Resistant: indestructible material characteristics ensure consistent marking quality

The ELS 16/40 or ELS 6/30-type labels give maximum marking quality when they are inserted into WKM cable markers and fastened with cable ties.

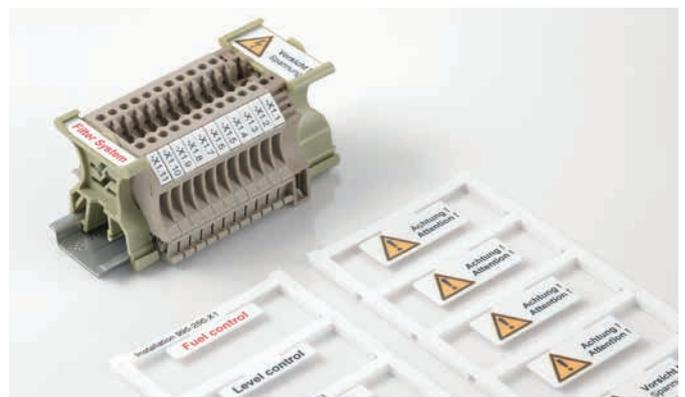

The ELS 16/40 and ELS 7/40 can be used for group identification by being positioned at the top of the carrier.



### Technical data

Material	Polyamide 66, halogen-free
UL 94 flammability rating	V2
Temperature range	-40 °C to 100 °C

### Ordering data

Colour	International colour code colours, not contained in the range, are available on request.
Special printing	Specify special printing and colours per using the M-Print® PRO software.
Printing	Black or colour
Possible printing systems	PrintJet CONNECT, PrintJet ADVANCED, MCP Plus 2, MCP Basic 2
Notes on mounting	ELS 6/30: EM 8/30 (1806120000) ELS 7/40: SCHAT 5 S (1631930000) ELS 16/40: SCHAT 5 (0292460000)
Minimum order quantity	1 pack = 5 cards

ELS MultiCard

ELS 6/30

6 mm

ELS 7/40

7 mm



Technical data

Material	Polyamide 66
Fire class acc. to UL 94	V-2
Ambient temperature (operational)	-40 °C...100 °C
Application/manufacturer	
Width	6 mm
Height	30 mm
Note	

Material	Polyamide 66
Fire class acc. to UL 94	V-2
Ambient temperature (operational)	-40 °C...100 °C
Application/manufacturer	
Width	7 mm
Height	40 mm
Note	

Material	Polyamide 66
Fire class acc. to UL 94	V-2
Ambient temperature (operational)	-40 °C...100 °C
Application/manufacturer	
Width	7 mm
Height	40 mm
Note	

Ordering data

<b>MultiCard Blank</b>	
yellow	●
white	○
<b>MultiCard Blank, self adhesive</b>	
white	○
<b>MultiCard custom printing</b>	
To customer specification	
Note	

Type	Qty.	Order No.
ELS 6/30 MC NE GE	80	1045580000
ELS 6/30 MC NE WS	80	1045570000
<b>MultiCard custom printing</b>		
ELS 6/30 K MC NE WS	80	1191390000
ELS 6/30 MC SDR	16	1045660000
Please send M-Print PRO file		

Type	Qty.	Order No.
ELS 7/40 MC NE GE	40	1045650000
ELS 7/40 MC NE WS	40	1045640000
<b>MultiCard custom printing</b>		
ELS 7/40 MC SDR	8	1045700000
Please send M-Print PRO file		

Accessories

<b>Connector markers</b>
<b>Cable markers</b>
Note

Type	Qty.	Order No.
EM 8/30	50	1806120000
WKM 8/30	50	1631910000

Type	Qty.	Order No.
SCHT 5 S	20	1631930000

Technical drawing / application



**ELS MultiCard - inlay tags**

**ELS MultiCard**

**ELS 16/40**

**16 mm**



**Technical data**

Material
Fire class acc. to UL 94
Ambient temperature (operational)
Application/manufacturer
Width
Height
<b>Note</b>

Polyamide 66
V-2
-40 °C...100 °C
16 mm
40 mm

**Ordering data**

<b>MultiCard Blank</b>
yellow <input checked="" type="radio"/>
white <input type="radio"/>
<b>MultiCard Blank, self adhesive</b>
white <input type="radio"/>
<b>MultiCard custom printing</b>
To customer specification
<b>Note</b>

Type	Qty.	Order No.
ELS 16/40 MC NE GE	40	1045630000
ELS 16/40 MC NE WS	40	1045620000
ELS 16/40 K MC NE WS	40	1411800000
ELS 16/40 MC SDR	8	1045690000
Please send M-Print PRO file		

**Accessories**

<b>Connector markers</b>
<b>Cable markers</b>
<b>Note</b>

Type	Qty.	Order No.
SCHT 5	20	0292460000
WKM 18/43	50	1610700000

**Technical drawing / application**

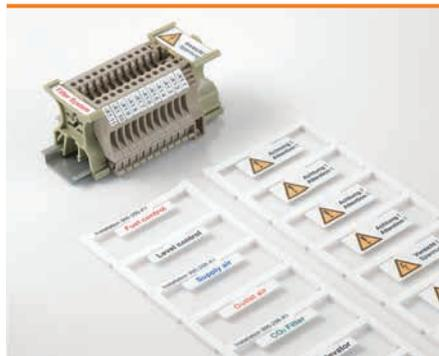



# Wire and cable markers

**Weidmüller's range of wire and cable markers provide you with solutions for a huge variety of applications.**

The applications range from thin wires through to cables with large external diameters. Amongst others, the assortment includes combination systems with individual markers, transparent sleeves and markers that are fastened using cable ties.

C

Open and closed, printed or blank markers for individual printing are available.

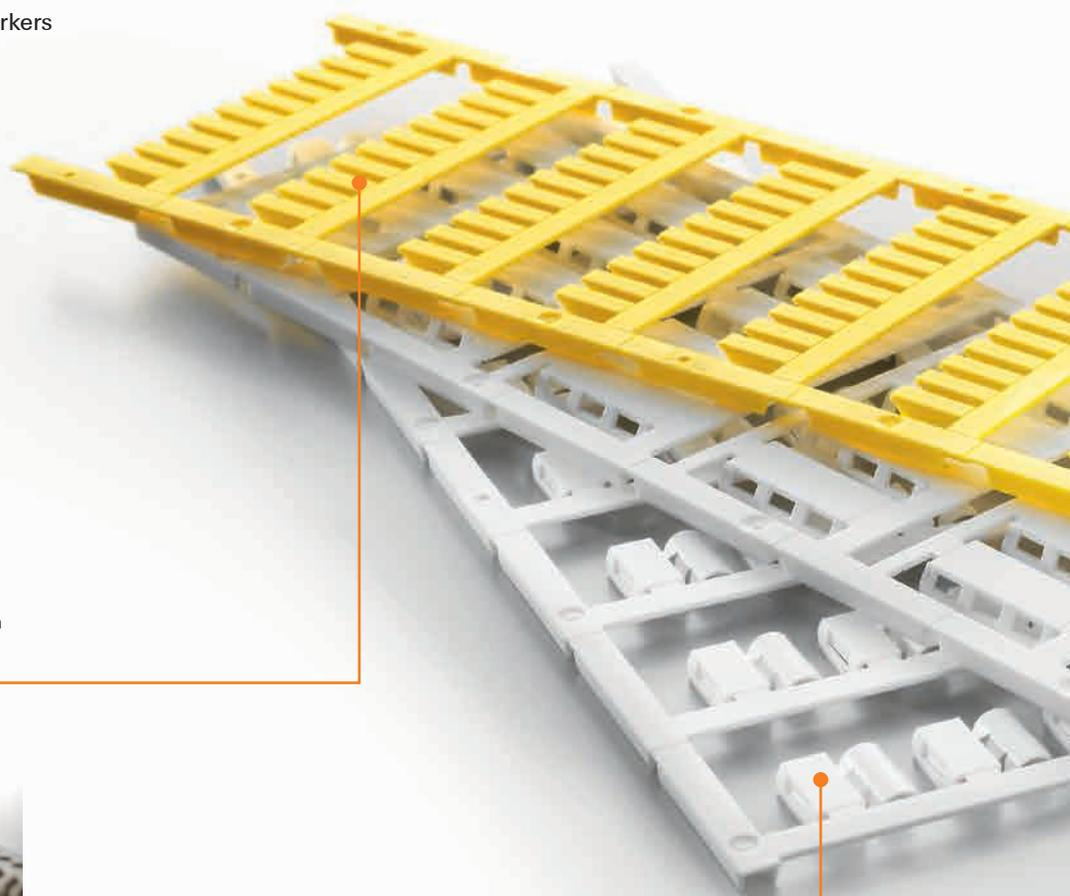

**SlimFix SF/SFR**

SlimFix are wire and cable markers featuring a space-saving design. The markers can also be attached to the wires after these have been installed.



**SlimFix Clip SFC**

With its exclusive locking mechanism, the SFC marker offers the security of a closed marker with the ease of installation of an open marker.





**TM-I with TM sleeves**

The special contour of the TM-I inlay tags in MultiCard format means easy assembly and firm seating in the appropriate TM sleeves.

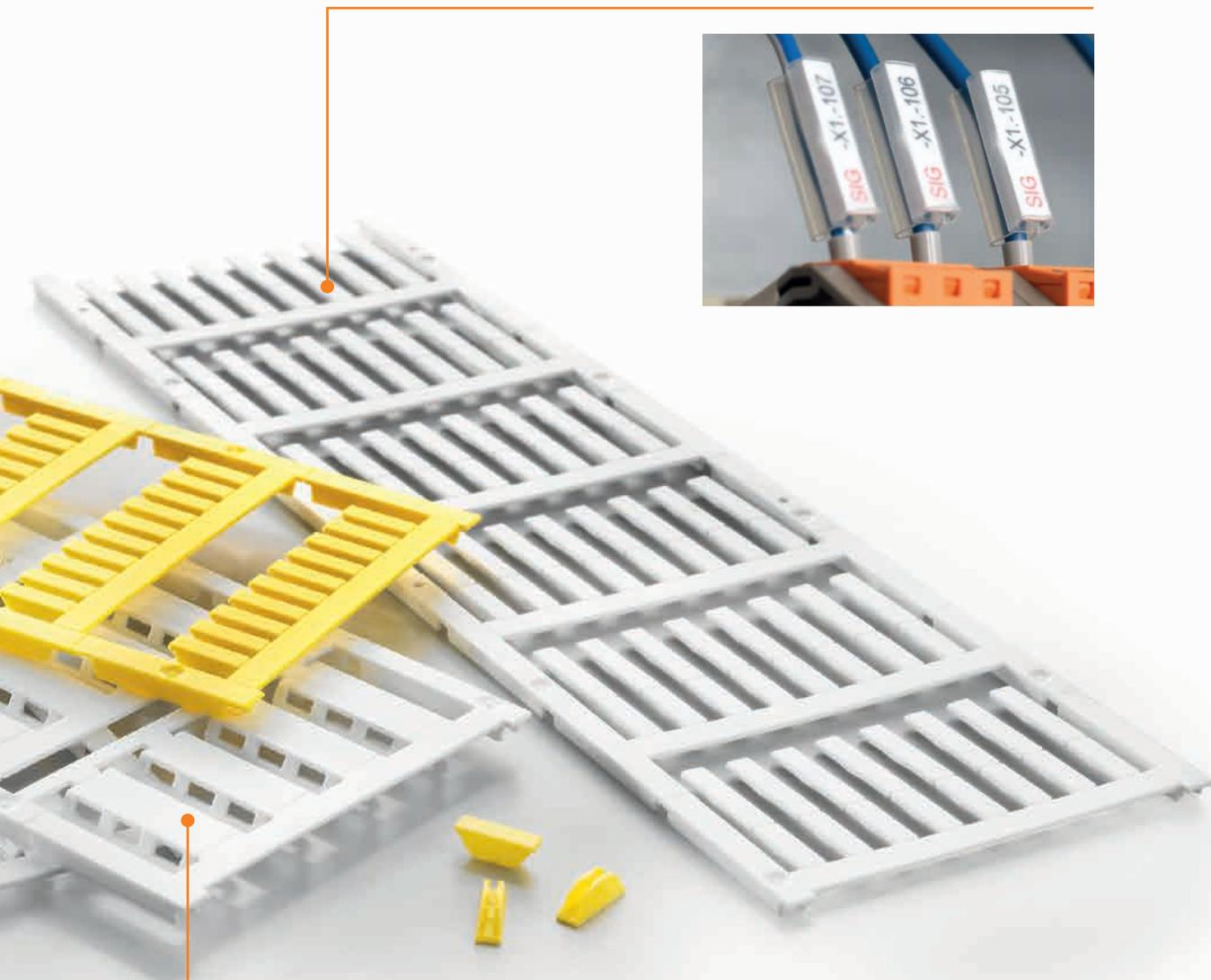

**SFX cable markers**

The SFX markers are suitable for identifying cables that are 7 mm in diameter and are distinguishable by their large marking surface.



**PrintJet CONNECT**

The PrintJet CONNECT is suitable for all plastic and metal markers from the MultiCard and MetalliCard families and achieves extremely durable, excellent printing results on all media.



## Wire and cable markers



Halogen-free and practically free of pollutants, Weidmüller's wire and cable markers comply with both European and in-house standards of well-known system manufacturers.

Systems are available for

- Clip-on, ready-to-use printed markers according to individual marking requirements.
- Marking by digits from a standard set of characters.
- Combination of individual pre-printed digits to form a character code.
- Customer labelling with PrintJet CONNECT, MCP plotters, THM printers, laser printers (DIN A4 format) or STI pens.

A sample selection is available in Weidmüller's sample boxes wire and cable markers: order no. **1640420000**.

Owing to the sheer number of possible applications and environmental influences such as moisture, radiation, gases or heat/cold to which the products can be exposed, Weidmüller accepts no liability for the suitability of products in all customer applications. Suitability tests for specific applications must therefore be carried out by the customer. However, Weidmüller will be happy to provide help and advice upon request.

Due to the different identification system available on the market, we wish to point out that Weidmüller does not guarantee industrial identification products if the Weidmüller components (markers – transparent sleeves – ink/toner/colour ink ribbons – printing systems) are combined with third-party products, unless Weidmüller has explicitly agreed for the purpose of an individual application.

# Applications chart

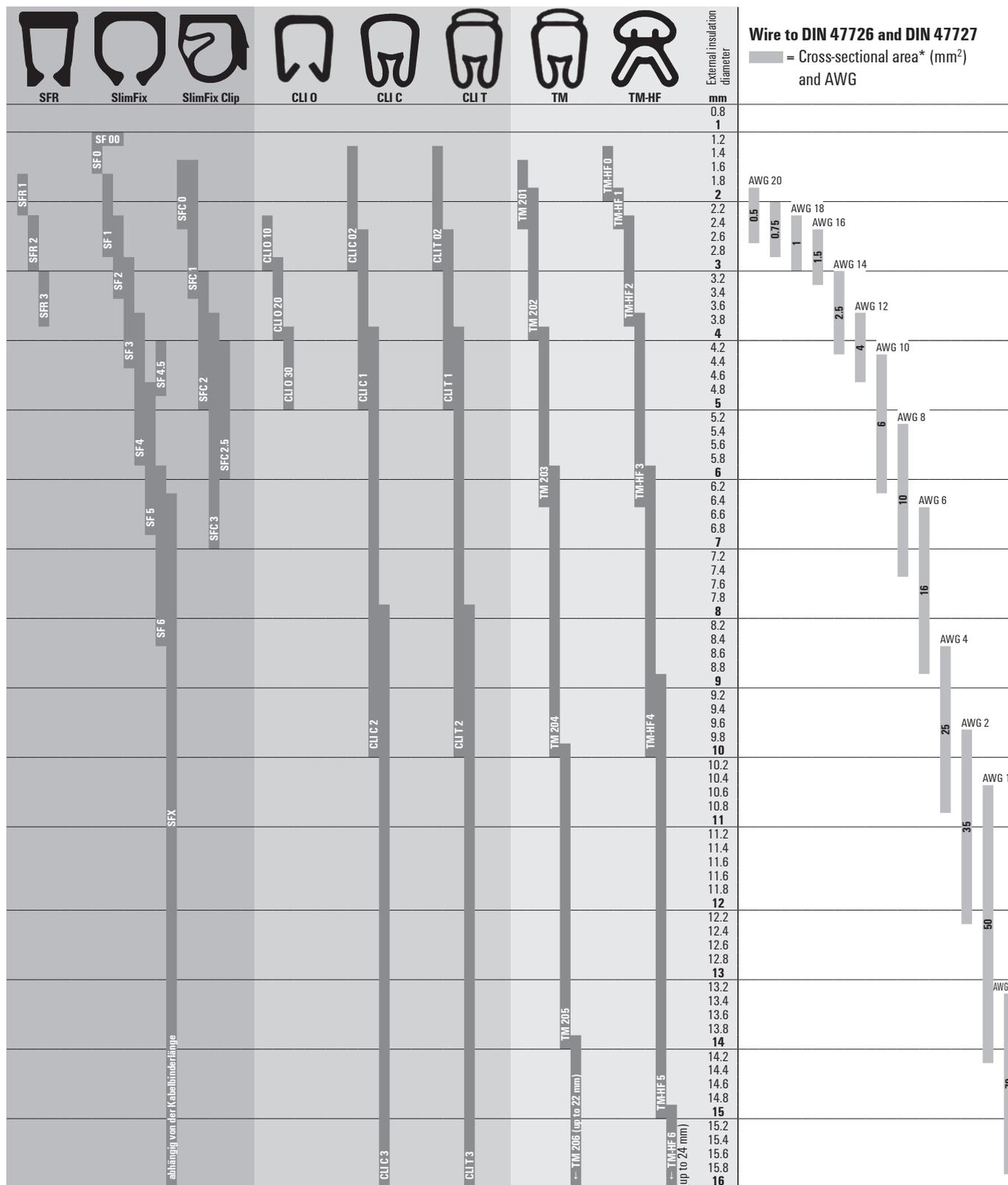

█ Chapter E Standard printed markers  
 █ Chapter F Accessories

\* Non-binding reference values. Please take into consideration the external diameter of the insulation.

# SF/SFR – SlimFix MultiCard

## Open cable markers for tough requirements

### The compact class tailored to lie close to the cable

SlimFix cable markers from the SF/SFR range are true all-rounders when it comes to meeting tough requirements. The markers are approved and listed for rail transportation systems and available in 12 mm or 21 mm long sleeves. They are suitable for use in areas with exposure to vibrations. Thanks to their close cut and compact shape, the sleeves attach tightly to the cables and give you an optimal cross-section range and secure marking when installing as a result. The SF range covers diameters from 1.0 to 7.8 mm and is fixed in position using the specialised SF tool. The SFR range covers cable diameters from 1.7 to 3.7 mm. The range is manually attached without the use of tools and does not influence adhesion of the markers in any way.

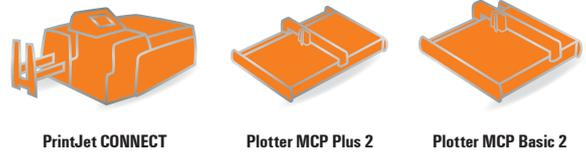

### SlimFix SF/SFR – the benefits to you

- Secure: firmly fixed, halogen-free and vibration-resistant sleeves
- Tested: recognised and listed for rail transportation systems
- User-friendly: the best material and assembly characteristics
- Also available in fire class V0. Please contact Weidmüller for details.

The fixed, SF-type SlimFix markers are fitted using the SF-tool in a matter of seconds and guarantee you a secure fit.

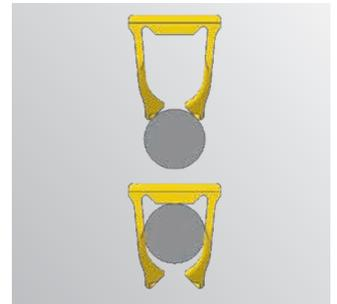

User-friendly, without any impairment to the excellent adhesive properties: tool-free assembly of SFR-type SlimFix markers.



### Technical data

Material	Polyamide 66, halogen-free
UL 94 flammability rating	V2
Temperature range	-40 °C to 100 °C

### Ordering data

Colour	International colour code colours, not contained in the range, are available on request.
Special printing	Specify special printing and colours per using the M-Print® PRO software.
Printing	Black or colour
Possible printing systems	PrintJet CONNECT, PrintJet ADVANCED, MCP Plus 2, MCP Basic
Notes on mounting	SF: Slide onto unconnected wires; attach to connected wires using SlimFix tool SFR: by pressing onto the wire
Minimum order quantity	1 pack = 5 cards

### Selection table

Type	Cond. ext. Ø. (max.) mm	Cond. cross-section mm <sup>2</sup>
SF 00	0.9 / 1.00 - 1.30	< 0.25
SF 0	1.20 - 1.60	0.25 - 0.50
SF 1	1.70 - 2.10	0.50 - 0.75
SF 2	2.20 - 2.90	0.75 - 1.50
SF 3	3.00 - 3.70	1.50 - 2.50
SF 4	3.60 - 6.00	2.50 - 4.00
SF 4.5	4.10 - 4.90	4.00 - 6.00
SF 5	4.80 - 7.40	6.00 - 10.00
SF 6	5.80 - 7.80	10.00 - 16.00
SFR 1	1.70 - 2.10	0.50 - 0.75
SFR 2	2.20 - 2.90	0.75 - 1.50
SFR 3	3.00 - 3.70	1.50 - 2.50

## SlimFix SF

## Technical data

Material	Temperature range	Fire class acc. to UL 94	Halogen
Polyamide 66	-40 °C...100 °C	V-2	No

## Ordering data

Type	Labelling field	Height	Qty.	white Order No.	yellow Order No.	blue Order No.	red Order No.	CSP Order No.
SF 00/12	12 x 3.2 mm	12 mm	400	1919290000	1919260000	1919270000	1919280000	1919300000
SF 00/21	21 x 3.2 mm	21 mm	400	1918580000	1918560000	1918590000	1918570000	1918530000
SF 0/12	12 x 3.2 mm	12 mm	400	1919240000	1919210000	1919220000	1919230000	1919250000
SF 0/21	21 x 3.2 mm	21 mm	400	1918500000	1918480000	1918510000	1918490000	1918470000
SF 1/12	12 x 3.2 mm	12 mm	400	1919390000	1919340000	1919360000	1919320000	1919420000
SF 1/21	21 x 3.2 mm	21 mm	400	1918630000	1918610000	1918620000	1918600000	1918640000
SF 2/12	12 x 3.6 mm	12 mm	400	1919490000	1919470000	1919480000	1919460000	1919500000
SF 2/21	21 x 3.6 mm	21 mm	400	1918690000	1918660000	1918700000	1918670000	1918650000
SF 3/12	12 x 4.6 mm	12 mm	320	1919540000	1919520000	1919550000	1919530000	1919510000
SF 3/21	21 x 4.6 mm	21 mm	320	1918910000	1918890000	1918920000	1918900000	1918880000
SF 4.5/21	21 x 7.4 mm	21 mm	96	1919020000	1919000000	1919030000	1919010000	1918990000
SF 4/12	12 x 5.7 mm	12 mm	128	1919600000	1919580000	1919590000	1919570000	1919610000
SF 4/21	21 x 5.7 mm	21 mm	192	1919080000	1919060000	1919090000	1919070000	1919050000
SF 5/12	12 x 7.4 mm	12 mm	160	1919650000	1919620000	1919630000	1919640000	1919660000
SF 5/21	21 x 7.4 mm	21 mm	160	1919140000	1919120000	1919150000	1919130000	1919110000
SF 6/21	21 x 8.4 mm	21 mm	160	1919190000	1919170000	1919200000	1919180000	1919160000
<b>Note</b>	CSP: Please send M-Print PRO file							

## Accessories

Type	Additional text	Qty.	Order No.
SF-TOOL 00-6	SLIMFIXTOOL FOR SF 00 BIS 6	10	1950820000
SF-TOOL 1	SLIM-FIX T FOR SF 1	10	1782970000
SF-TOOL 2-3	SLIM-FIX T FOR SF 2-3	10	1782960000
SF-TOOL 4-5	SLIM-FIX T FOR SF 4-5	10	1782980000
SF-TOOL-SORTIMENT	3 PIECES OF TOOL 1, TOOL 2-3, TOOL 4-5	1	1770080000

## SlimFix SFR

## Technical data

Material	Temperature range	Fire class acc. to UL 94	Halogen
Polyamide 66	-40 °C...100 °C	V-2	No

## Ordering data

Type	Labelling field	Height	Qty.	white Order No.	yellow Order No.	CSP Order No.
SFR 1/12	12 x 3.2 mm	12 mm	400	1318640000	1318650000	1318770000
SFR 1/21	21 x 3.2 mm	21 mm	400	1318710000	1318720000	1318810000
SFR 2/12	12 x 3.2 mm	12 mm	400	1318660000	1318670000	1318780000
SFR 2/21	21 x 3.2 mm	21 mm	400	1318730000	1318740000	1318820000
SFR 3/12	12 x 4.6 mm	12 mm	256	1318680000	1318690000	1318790000
SFR 3/21	21 x 4.6 mm	21 mm	256	1318750000	1318760000	1318830000
<b>Note</b>	CSP: Please send M-Print PRO file					

# SFX – SlimFix MultiCard

## Intelligent cable marking with cable tie feed-through

### Wide range of options and handling advantages

The SFX-range of SlimFix markers can be used for cable diameters from 7.0 mm. The maximum diameter is only limited by the length of the cable tie that is used. The versions with ergonomically designed cable tie feedthrough are particularly easy to handle. A bevel makes feeding the cable tie-in simple.

In factory halls that appear to be clean, temperature, UV light – such as that produced by simple fluorescent tubes – and small amounts of chemical compounds affect the service life of all plastic products. Weidmüller has therefore extended its successful family of SFX cable markers from the MultiCard series to include variants that offer improved durability. Furthermore, the fire classification according to UL 94 has been increased to V0.

### SlimFix SFX – the benefits to you

- Large variety: the right size for every label
- Time optimised: simple assembly thanks to the ergonomically designed cable tie feed-through
- Sturdy: resistant even with high mechanical demands



#### Technical data SFX V2

Material	Polyamide 66, halogen-free
UL 94 flammability rating	V2
Temperature range	-40 °C to 100 °C

#### Technical data SFX V0

Material	Polyamide 66, halogen-free
UL 94 flammability rating	V0
Temperature range	-50 °C to 120 °C

#### Technical data SFX Detectable

Material	Polyamide 66, halogen-free
UL 94 flammability rating	HB
Temperature range	-40 °C to 100 °C

#### Ordering data

Colour	International colour code colours, not contained in the range, are available on request.
Special printing	Specify special printing and colours per using the M-Print® PRO software.
Printing	Black or colour
Possible printing systems	PrintJet CONNECT, PrintJet ADVANCED, MCP Plus 2, MCP Basic 2
Notes on mounting	Attach using cable ties
Minimum order quantity	1 pack = 5 cards

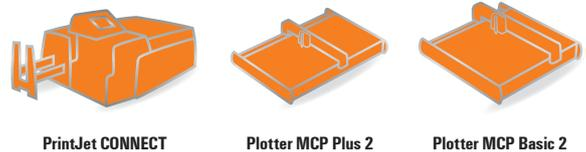

The maximum diameter of the marker is determined by the length of the cable tie; it can be secured by the use of one or two cable ties.

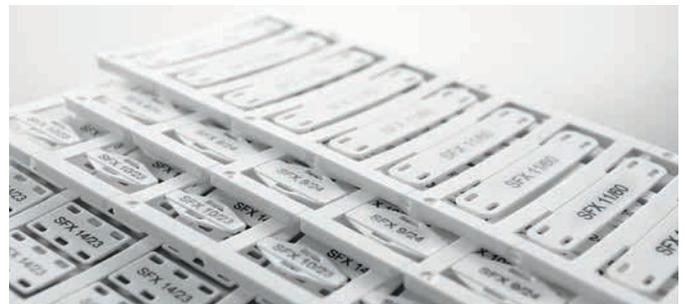

Optimum space usage in the application area and needs-based labelling surfaces of various sizes.



Optimised assembly properties thanks to the bevelled cable tie feed-through which is found in the SFX 9/24 S, SFX 9/40 S and SFX 10/60 S-type markers.

## SlimFix SFX V2

## Technical data

Material	Temperature range	Fire class acc. to UL 94	Halogen	Wire O.D.	Connection cross-section
Polyamide 66	-40 °C...100 °C	V-2	No	7 - 40 mm	16 - 500 mm <sup>2</sup>

## Ordering data

Type	Labelling field	Height	Qty.	white Order No.	yellow Order No.	blue Order No.	red Order No.	CSP Order No.	
SFX 9/24	23.9 x 9 mm	24 mm	160	1852490000	1852460000	1852500000	1852470000	1852480000	
SFX 10/23	23 x 5 mm	23 mm	160	1852390000	1852360000	1852400000	1852370000	1852380000	
SFX 11/60	44 x 11 mm	60 mm	60	1860120000	1860150000	1051870000	1963650000	1860140000	
SFX 14/23	23 x 8 mm	23 mm	160	1852440000	1852410000	1852450000	1852420000	1852430000	
SFX 30/60	45 x 30 mm	60 mm	30	1083230000	1083240000	1369540000	1369550000	1083260000	
SFX 9/24 S	23.9 x 9 mm	24 mm	120	1323440000	1323450000	1323480000	1323470000	1323490000	
SFX 9/40 S	40 x 8.5 mm	40 mm	80	1248760000	1248770000	1248790000	1248780000	1248740000	
SFX 10/60 S	60 x 9.5 mm	60 mm	50	1248810000	1248820000	1248840000	1248830000	1248750000	
<b>Note</b>	CSP: Please send M-Print PRO file								

## SlimFix SFX V0

## Technical data

Material	Temperature range	Fire class acc. to UL 94	Halogen	Wire O.D.	Connection cross-section
Polyamide 66	-50 °C...120 °C	V-0	No	7 - 40 mm	16 - 500 mm <sup>2</sup>

## Ordering data

Type	Labelling field	Height	Qty.	white Order No.	yellow Order No.
VT SFX 9/24 V0	23.9 x 9 mm	24 mm	320	1727740001	1727740004
VT SFX 10/23 V0	23 x 5 mm	23 mm	320	1727770001	1727770004
VT SFX 14/23 V0	23 x 8 mm	23 mm	320	1689490001	1689490004
SFX 9/24 S V0	23.9 x 9 mm	24 mm	120	2009930000	2009940000
SFX 9/40 S V0	40 x 8.5 mm	40 mm	80	2009910000	2009920000
SFX 10/60 S V0	60 x 9.5 mm	60 mm	50	2009890000	2009900000
SFX 11/60 V0	44 x 11 mm	60 mm	60	1432750000	1076890000
<b>Note</b>	CSP: Please send M-Print PRO file				

## SlimFix SFX Detectable

## Technical data

Material	Temperature range	Fire class acc. to UL 94	Halogen	Wire O.D.	Connection cross-section
Polyamide 66	-40 °C...100 °C	HB	No	7 - 40 mm	16 - 500 mm <sup>2</sup>

## Ordering data

Type	Labelling field	Height	Qty.	blue Order No.
SFX-DT 10/60 S	60 x 9.5 mm	60 mm	50	2602740000
SFX-DT 11/60	44 x 11 mm	60 mm	60	2602730000
SFX-DT 9/24	23.9 x 9 mm	24 mm	160	2602720000
<b>Note</b>	CSP: Please send M-Print PRO file			

# SFC – SlimFix Clip MultiCard

## A convenient clip system for wires and cables

### Highly durable markers with extra security

The halogen-free SlimFix Clips are made from sturdy polyamide 66 and combine two advantages in one product. Their unique clip closure means they can be fitted at every stage in the installation as easily as an open marker while still offering you the application-based security of a closed marker.

The markers are designed for wire and cable diameters from 1.5 to 7.0 mm, have labelling surfaces up to 30 mm long to give you enough space for extensive character strings which are easily legible and can be printed onto the differently coloured markers using the PrintJet CONNECT printer.

### SlimFix Clip SFC – the benefits to you

- Compact: secure and quick fitting without additional tools
- Informative: large labelling surface for long character strings
- Strong combinations: different colours and sizes
- Individual: can be printed using PrintJet CONNECT

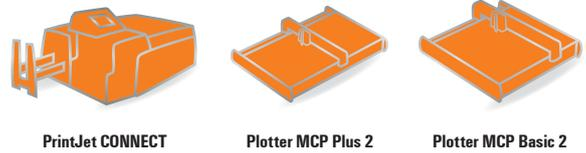

PrintJet CONNECT

Plotter MCP Plus 2

Plotter MCP Basic 2



The SFC is fitted quickly and simply using its clip closure system – no need for additional tools.



Optimal cross-sectional range in all sizes: SFC-type markers in 5 sizes for wire diameters from 1.5 to 7.0 mm.



### Technical data

Material	Polyamide 66, halogen-free
UL 94 flammability rating	V2
Temperature range	-40 °C to 100 °C

### Ordering data

Colour	International colour code colours, not contained in the range, are available on request.
Special printing	Specify special printing and colours per using the M-Print® PRO software.
Printing	Black or colour
Possible printing systems	PrintJet CONNECT, PrintJet ADVANCED, MCP Plus 2, MCP Basic 2
Minimum order quantity	1 pack = 5 cards

### Selection table

Type	Wire, ext. ø	Wire cross-section
SFC 0	1.5 - 2.5 mm	0.5 - 1.0 mm <sup>2</sup>
SFC 1	2.0 - 3.5 mm	0.75 - 2.5 mm <sup>2</sup>
SFC 2	3.0 - 5.0 mm	2.5 - 4.0 mm <sup>2</sup>
SFC 2.5	4.0 - 6.0 mm	4.0 - 10 mm <sup>2</sup>
SFC 3	3.5 - 7.0 mm	4.0 - 10 mm <sup>2</sup>



## SlimFix SFC

## Technical data

Material	Temperature range	Fire class acc. to UL 94	Halogen
Polyamide 66	-40 °C...100 °C	V-2	No

## Ordering data

Type	Labelling field	Height	Qty.	white Order No.	yellow Order No.	blue Order No.	red Order No.	CSP Order No.
SFC 0/12	12 x 4.1 mm	12 mm	200	1813130000	1813160000	1813170000	1813150000	1813180000
SFC 0/21	21 x 4.1 mm	21 mm	200	1813190000	1813210000	1813220000	1813200000	1813230000
SFC 0/30	30 x 4.1 mm	30 mm	150	1813240000	1813260000	1813270000	1813250000	1813280000
SFC 1/12	12 x 4.1 mm	12 mm	200	1747320001	1747320004	1747320002	1747320003	1752720000
SFC 1/21	21 x 4.1 mm	21 mm	200	1779080001	1779080004	1779080002	1779080003	1779090000
SFC 1/30	30 x 4.1 mm	30 mm	150	1805760000	1805730000	1805720000	1805740000	1805750000
SFC 2/12	12 x 5.8 mm	12 mm	120	1758320001	1758320004	1758320002	1758320003	1763480000
SFC 2/21	21 x 5.8 mm	21 mm	120	1805810000	1805780000	1805770000	1805790000	1805800000
SFC 2/30	30 x 5.8 mm	30 mm	90	1805870000	1805830000	1805820000	1805850000	1805860000
SFC 2.5/12	12 x 5.8 mm	12 mm	120	1062000000	1062010000	1062030000	1062020000	1062040000
SFC 2.5/21	21 x 5.8 mm	21 mm	120	1062050000	1062070000	1062090000	1062080000	1062110000
SFC 3/12	12 x 5 mm	12 mm	80	1025220000	1025230000	1025250000	1025240000	1025550000
SFC 3/21	21 x 5 mm	21 mm	80	1025260000	1025270000	1025300000	1025290000	1025560000
SFC 3/30	30 x 5 mm	30 mm	60	1025310000	1025320000	1025340000	1025330000	1025570000

Note CSP: Please send M-Print PRO file



# TM-I MultiCard - inlay tags

## Contour-hugging signs for all sleeves

### The compatible markers with the bonus of being exchangeable

The 12 to 30 mm long TM-I signs stand out on all levels due to their maximum flexibility when assembling sleeves. The sophisticated contouring of the signs ensures that they fit securely and also allow for easy assembly and exchange. The project marking surface is typical for MultiCard markers and gives maximum clarity during isolation and assembly. For this, fitting or exchanging the signs can be done easily before or after the sleeves have been attached. The markers are recognised and listed for transportation engineering. The markers in the range come in five, partly combinable, lengths and are compatible with many commonly available sleeves. The right sign for every sleeve!

### TM-I - the benefits to you

- Strong detail: ideal assembly characteristics thanks to the special sign contour
- Clear: project marker surfaces for better orientation and easy isolation
- Optional: can be used with many commonly available sleeves
- Not suited for labelling with P-Ink or STI pen in combination with CLI T sleeves

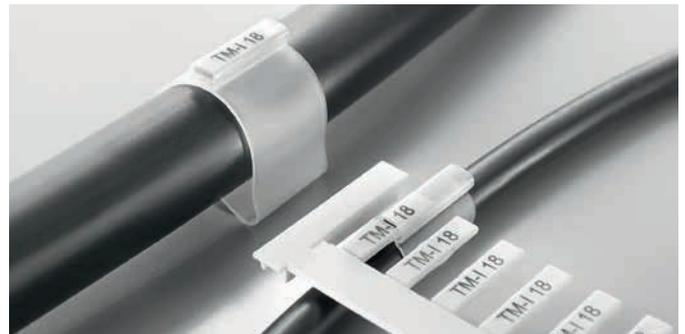
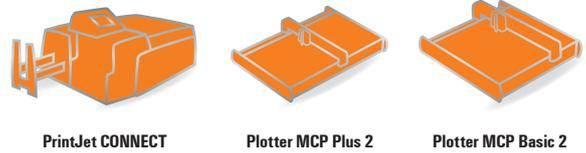

Trouble-free assembly before or after the sleeve is fitted as well as easy replacement of the signs.



Always the right sign length, for character sequences of up to 21 characters.



For differentiated marking of different information in one place, the TM-I 12/18 has two combinable sign lengths.



### Technical data

Material	Polyamide 66, halogen-free
UL 94 flammability rating	V2
Temperature range	-40 °C to 100 °C

### Ordering data

Colour	International colour code colours, not contained in the range, are available on request.
Special printing	Specify special printing and colours per using the M-Print® PRO software.
Printing	Black or colour
Possible printing systems	PrintJet CONNECT, PrintJet ADVANCED, MCP Plus 2, MCP Basic 2
Minimum order quantity	1 pack = 5 cards

TM-I

Technical data

Material	Temperature range	Fire class acc. to UL 94	Adhesive	Halogen
Polyamide 66	-40...100 °C	V-2		No

Ordering data

Order No.	Type	Colour	Height	Width	Qty.
1718411044	TM-I 12 MC NE WS	○	12 mm	4 mm	320
1718411686	TM-I 12 MC NE RT	●	12 mm	4 mm	320
1718411687	TM-I 12 MC NE GE	●	12 mm	4 mm	320
1718411693	TM-I 12 MC NE BL	●	12 mm	4 mm	320
1323730000	TM-I 12/18 MC NE WS	○	30 mm	4 mm	240
1421170000	TM-I 12/18 MC NE RT	●	30 mm	4 mm	240
1409630000	TM-I 12/18 MC NE GE	●	30 mm	4 mm	240
1421160000	TM-I 12/18 MC NE BL	●	30 mm	4 mm	240
1609981044	TM-I 15 MC NE WS	○	15 mm	4 mm	400
1609981686	TM-I 15 MC NE RT	●	15 mm	4 mm	400
1609981687	TM-I 15 MC NE GE	●	15 mm	4 mm	400
1609981693	TM-I 15 MC NE BL	●	15 mm	4 mm	400
1718431044	TM-I 18 MC NE WS	○	18 mm	4 mm	320
1718431686	TM-I 18 MC NE RT	●	18 mm	4 mm	320
1718431687	TM-I 18 MC NE GE	●	18 mm	4 mm	320
1718431693	TM-I 18 MC NE BL	●	18 mm	4 mm	320
1680411044	TM-I 20 MC NE WS	○	20 mm	4 mm	400
1680411686	TM-I 20 MC NE RT	●	20 mm	4 mm	400
1680411687	TM-I 20 MC NE GE	●	20 mm	4 mm	400
1680411693	TM-I 20 MC NE BL	●	20 mm	4 mm	400
1428480000	TM-I 23 MC NE WS	○	23 mm	4 mm	400
1428510000	TM-I 23 MC NE RT	●	23 mm	4 mm	400
1428490000	TM-I 23 MC NE GE	●	23 mm	4 mm	400
1428520000	TM-I 23 MC NE BL	●	23 mm	4 mm	400
1876390000	TM-I 30 MC NE WS	○	30 mm	4 mm	300
1876380000	TM-I 30 MC NE RT	●	30 mm	4 mm	300
1876370000	TM-I 30 MC NE GE	●	30 mm	4 mm	300
1876400000	TM-I 30 MC NE BL	●	30 mm	4 mm	300

TM-I custom printing

Technical data

Material	Temperature range	Fire class acc. to UL 94	Adhesive	Halogen
Polyamide 66	-40...100 °C	V-2		No

Ordering data

Order No.	Type	Colour	Height	Width	Qty.
1718420000	TM-I 12 MC SDR	CSP	12 mm	4 mm	64
1323720000	TM-I 12/18 MC SDR	CSP	30 mm	4 mm	48
1609990000	TM-I 15 MC SDR	CSP	15 mm	4 mm	80
1718440000	TM-I 18 MC SDR	CSP	18 mm	4 mm	64
1680420000	TM-I 20 MC SDR	CSP	20 mm	4 mm	80
1433880000	TM-I 23 MC SDR	CSP	23 mm	4 mm	80
1876320000	TM-I 30 MC SDR	CSP	30 mm	4 mm	60

Please send M-Print PRO file

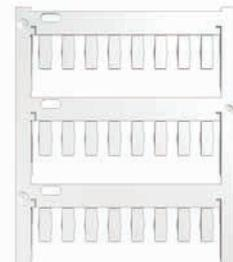

# ELS MultiCard

## Resilient, inlay tags

### A resilient interior for cable markers or tag carriers

Optimally designed for use in WKM cable markers or SchT 5-type tag carriers, the ELS tags meet the highest requirements where prominent identification of cables and terminal strips is needed. The high-quality markers are made of polyamide 66. This guarantees a constant, high-quality appearance and clear and simple presentation of information even under the extremely demanding conditions where oil, water or other fluids are present.

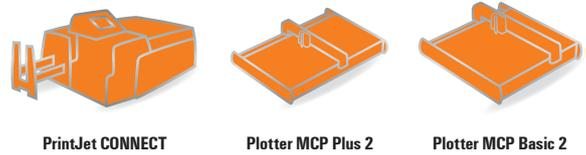

The ELS 16/40 or ELS 6/30-type labels give maximum marking quality when they are inserted into WKM cable markers and fastened with cable ties.

### ELS inlay tags – the benefits to you

- Perfectly fitting: in flat form they are the perfect inserts for WKM or SchT 5-type
- Resistant: indestructible material characteristics ensure consistent marking quality

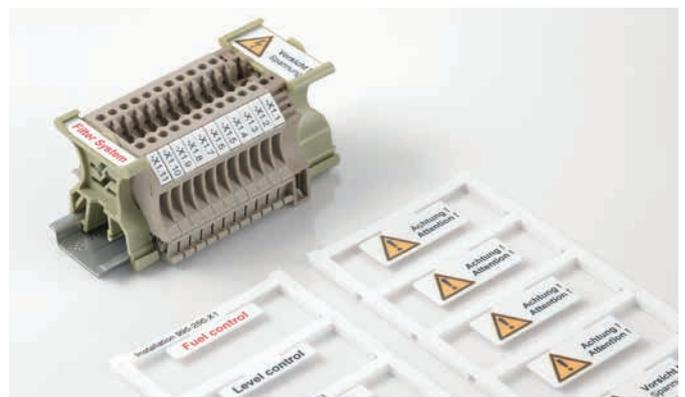

The ELS 16/40 and ELS 7/40 can be used for group identification by being positioned at the top of the carrier.



### Technical data

Material	Polyamide 66, halogen-free
UL 94 flammability rating	V2
Temperature range	-40 °C to 100 °C

### Ordering data

Colour	International colour code colours, not contained in the range, are available on request.
Special printing	Specify special printing and colours per using the M-Print® PRO software.
Printing	Black or colour
Possible printing systems	PrintJet CONNECT, PrintJet ADVANCED, MCP Plus 2, MCP Basic 2
Notes on mounting	ELS 6/30: WKM 8/30 (1631910000) ELS 16/40: WKM 18/43 (1610700000)
Minimum order quantity	1 pack = 5 cards

ELS MultiCard

ELS 6/30

6 mm

ELS 16/40

16 mm



Technical data

Material	Polyamide 66
Fire class acc. to UL 94	V-2
Ambient temperature (operational)	-40 °C...100 °C
Application/manufacturer	
Width	6 mm
Height	30 mm
Note	

Material	Polyamide 66
Fire class acc. to UL 94	V-2
Ambient temperature (operational)	-40 °C...100 °C
Application/manufacturer	
Width	16 mm
Height	40 mm
Note	

Material	Polyamide 66
Fire class acc. to UL 94	V-2
Ambient temperature (operational)	-40 °C...100 °C
Application/manufacturer	
Width	16 mm
Height	40 mm
Note	

Ordering data

<b>MultiCard Blank</b>	
yellow	●
white	○
<b>MultiCard Blank, self adhesive</b>	
white	○
<b>MultiCard custom printing</b>	
To customer specification	
Note	

Type	Qty.	Order No.
ELS 6/30 MC NE GE	80	1045580000
ELS 6/30 MC NE WS	80	1045570000
<b>MultiCard custom printing</b>		
ELS 6/30 K MC NE WS	80	1191390000
ELS 6/30 MC SDR	16	1045660000
Please send M-Print PRO file		

Type	Qty.	Order No.
ELS 16/40 MC NE GE	40	1045630000
ELS 16/40 MC NE WS	40	1045620000
<b>MultiCard custom printing</b>		
ELS 16/40 K MC NE WS	40	1411800000
ELS 16/40 MC SDR	8	1045690000
Please send M-Print PRO file		

Accessories

<b>Connector markers</b>
<b>Cable markers</b>
Note

Type	Qty.	Order No.
EM 8/30	50	1806120000
WKM 8/30	50	1631910000

Type	Qty.	Order No.
SCHT 5	20	0292460000
WKM 18/43	50	1610700000

Technical drawing / application



# Individual processing

## The professional system for every standard



PrintJet CONNECT

### Superior components in a comprehensive product line

Our labelling system allows you to label with precision and speed – without losing track.

Our completely matched line of materials, sizes and mounting options cover solutions for all of your particular operational needs.

The systematic use of PrintJet CONNECT and the M-Print®-PRO-software enables you to custom design and process facility labelling for all of your system components. The result is a consistently outstanding marking system.



A special punched-out hole in the SFX-M 11/60 enables use with steel cable ties, and with plastic cable ties with the SFX-M 11/60-5.

### The benefits for you

- Quality: durable materials for extreme conditions
- Customised: perfectly matched system components provide the best variety
- Efficient: tailor-made solutions from a single source
- Professional: in-house control of all marking processes
- Flexible: Excellent assembly characteristics



The universal inlay is designed to accept eight different tag types and is particularly suitable for printing small batch jobs.

### Technical data

Tag material	Micro etching steel 1.4301 (ST) or chromal coated aluminium (AL)
Temperature range	-55 °C to +130 °C
Thickness	0.5 mm
Primer	100 impregnated cloths and hermetically sealed
Possible printing systems	PrintJet CONNECT, PrintJet ADVANCED

MetalliCard

SFX-M 11/60-5

11 mm

SFX-M 11/60

11 mm



Technical data

Ambient temperature (operational)
Width
Height
Cable tie passage
Diameter
Labelling field
<b>Note</b>

Ambient temperature (operational)	-55 °C...130 °C
Width	11 mm
Height	60 mm
Cable tie passage	Flat
Diameter	
Labelling field	11.2 x 45 mm
<b>Note</b>	

Ambient temperature (operational)	-55 °C...130 °C
Width	11 mm
Height	60 mm
Cable tie passage	Raised
Diameter	
Labelling field	11.2 x 45 mm
<b>Note</b>	

Ordering data

<b>MetalliCard Blank</b>	
	Micro-etched stainless steel 1.4301 (ST)
	Chrome coated aluminium (AL)
<b>MetalliCard custom printing</b>	
	Micro-etched stainless steel 1.4301 (ST)
	Chrome coated aluminium (AL)
<b>Note</b>	

Type	Qty.	Order No.
SFX-M 11/60-5 ST	50	1422570000
SFX-M 11/60-5 AL	50	1422560000
<b>SFX-M 11/60-5 AL SDR</b>		
SFX-M 11/60-5 AL SDR	1	1474440000
Please send M-Print PRO file		

Type	Qty.	Order No.
SFX-M 11/60 ST	50	1327790000
SFX-M 11/60 AL	50	1327780000
<b>SFX-M 11/60 ST SDR</b>		
SFX-M 11/60 ST SDR	1	1474430000
Please send M-Print PRO file		

Accessories

Primer for pretreatment
Inlay
Inlay
<b>Note</b>

Type	Qty.	Order No.
PRIMER CC-M	100	2068020000
INLAY SFX-M 11/60	1	1341110000
INLAY CC-M UNIVERSAL	1	1341120000

Type	Qty.	Order No.
PRIMER CC-M	100	2068020000
INLAY SFX-M 11/60	1	1341110000
INLAY CC-M UNIVERSAL	1	1341120000

Technical drawing / application

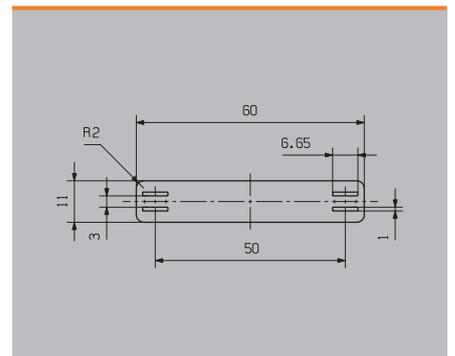
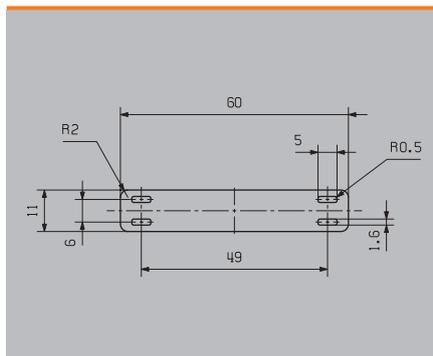

**MetalliCard - individual processing**

**MetalliCard**

**SFX-M 17/60-5**

**17 mm**

**SFX-M 12/40-5**

**12 mm**



**Technical data**

Ambient temperature (operational)
Width
Height
Cable tie passage
Diameter
Labelling field
<b>Note</b>

-55 °C...130 °C
17 mm
60 mm
Flat
17.2 x 40 mm

-55 °C...130 °C
12 mm
40 mm
Flat
12.2 x 25 mm

**Ordering data**

<b>MetalliCard Blank</b>
Micro-etched stainless steel 1.4301 (ST)
Chrome coated aluminium (AL)
<b>MetalliCard custom printing</b>
Micro-etched stainless steel 1.4301 (ST)
Chrome coated aluminium (AL)
<b>Note</b>

Type	Qty.	Order No.
SFX-M 17/60-5 ST	50	1500270000
SFX-M 17/60-5 AL	50	1500250000
SFX-M 17/60-5 ST SDR	1	1505240000
SFX-M 17/60-5 AL SDR	1	1505230000

Please send M-Print PRO file

Type	Qty.	Order No.
SFX-M 12/40-5 ST	50	1500240000
SFX-M 12/40-5 AL	50	1500230000
SFX-M 12/40-5 ST SDR	1	1505220000
SFX-M 12/40-5 AL SDR	1	1505210000

Please send M-Print PRO file

**Accessories**

Primer for pretreatment
Inlay
Inlay
<b>Note</b>

Type	Qty.	Order No.
PRIMER CC-M	100	2068020000
INLAY SFX-M 17/60	1	1500330000

Type	Qty.	Order No.
PRIMER CC-M	100	2068020000
INLAY SFX-M 11/60	1	1341110000
INLAY CC-M UNIVERSAL	1	1341120000

**Technical drawing / application**

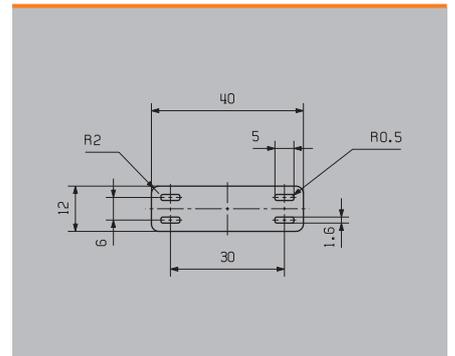
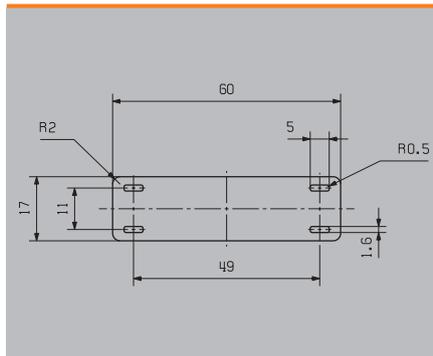





## Markers for devices and installations

Device and installation markers round off our range of switchgear markers. Employing our device markers means you will be in compliance with official regulations on the marking of electrical equipment. Weidmüller offers corresponding markers for devices made by well-known manufactures. Mirroring their original counterparts, these markers are attached with the traditional adhesive or rapid clip-on techniques. By using the corresponding software and system-compatible printer or plotter system, you can print your own markings on these markers.

### ESG

The ESG MultiCard markers are for all well-known device manufacturers; with all-purpose usage thanks to self-adhesive or snap-on markers.

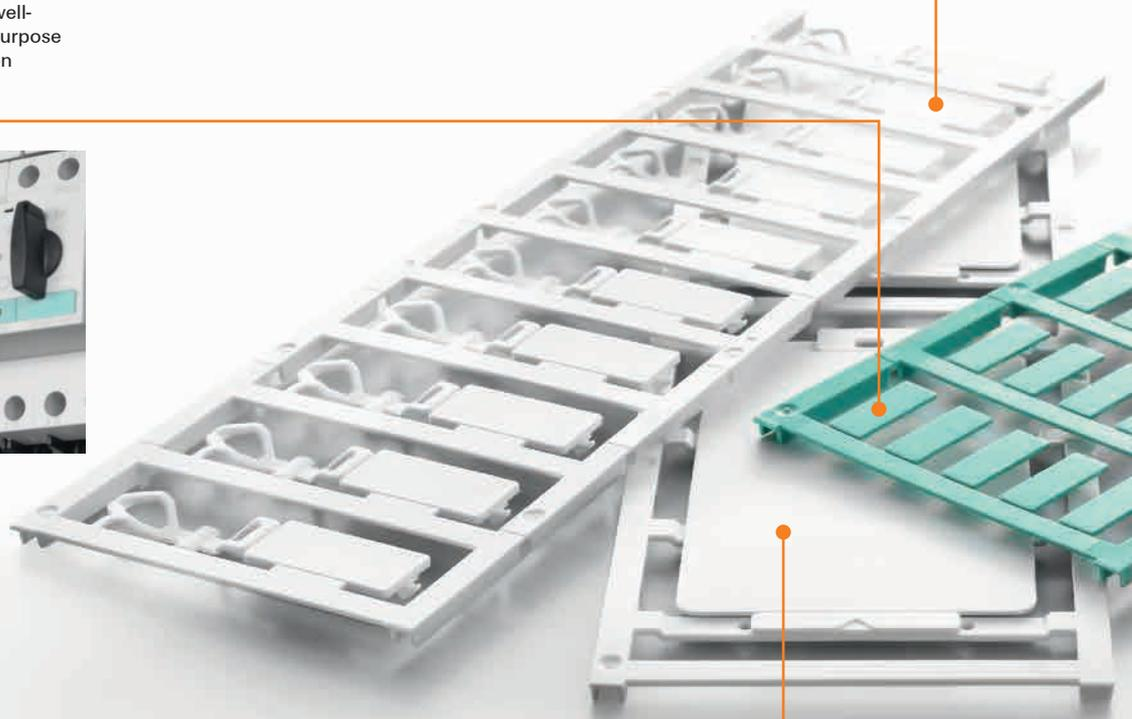

### ClipCard

ClipCard MultiCard markers are a genuine alternative to engraving. Flexible fastening options using holders, tag rails, self-adhesive, screws or rivets.



**DMC**

The marking surface (12 x 27 mm) is large enough to hold information about the device and its function. The markers are fastened to a wire or cable by means of a simple clip-on mechanism.



**SwitchMark**

SwitchMark MultiCard markers are ideal for identifying control and signalling equipment.

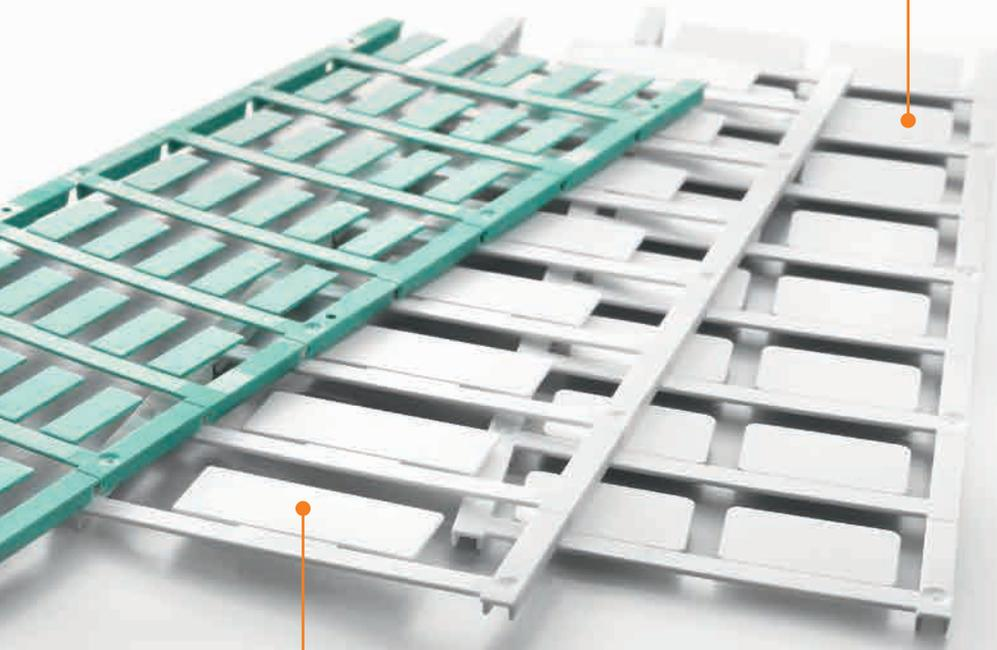

**ELS**

Optimally designed for use in WKM cable markers or SchT 5-type tag carriers, the ELS tags meet the highest requirements where prominent identification of cables and terminal strips is needed.



**PrintJet CONNECT**

The PrintJet CONNECT is suitable for all plastic and metal markers from the MultiCard and MetalliCard families and achieves extremely durable, excellent printing results on all media.



# Markers for devices and installations

Device and installation markers round off our range of switchgear markers. Employing our device markers means you will be in compliance with official regulations on the marking of electrical equipment. Weidmüller offers corresponding markers for devices made by well-known manufacturers. Mirroring their original counterparts, these markers are attached with the traditional adhesive or rapid clip-on techniques. By using the corresponding software and system-compatible printer or plotter system, you can print your own markings on these markers.

A samples box containing a selection of device and installation markers is available under the order no. **1646370000**.

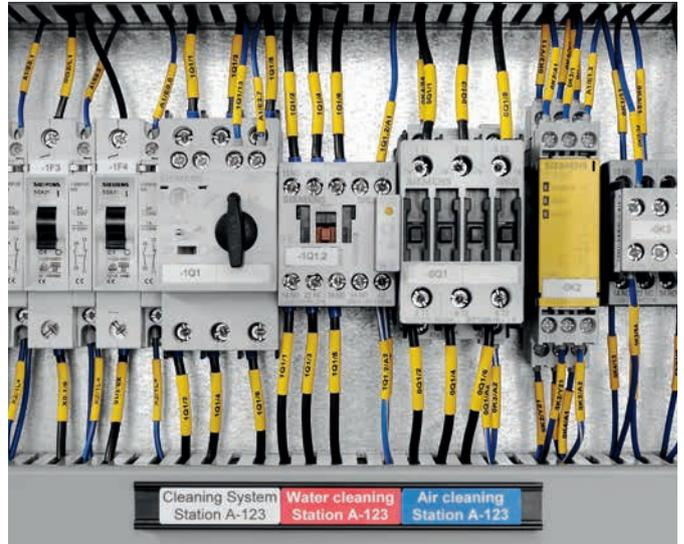

	DMC	ESG	SwitchMark	ClipCard	MetalliCard
--	-----	-----	------------	----------	-------------



Cable ducts				●	●
Automatic switchgear	●	●	●	●	●
Contactors	●	●	●		
Electrical connections	●			●	●
Electrical devices	●			●	●
Machines					●
LED displays			●		●
Keyboards			●	●	●
Lamps					●
Murr valve plug		●			
Tubes				●	●
Circuit-breakers	●	●			●
Relays	●	●			
Shelves					●
Switches		●	●	●	
Control desk		●	●	●	●
Transformers	●	●			●
Valves				●	●



Water cleaning Station A-124   Air cleaning Station A-124   Cleaning System Station A-125   Water clean Station A-

# DMC MultiCard

## Reliable equipment identification on wires and cables

### Snap-fit mechanism for absolutely secure attachment

Maximum visibility when labelling switching devices or components can be achieved using the single-piece DMC markers. The sophisticated snap-fit mechanism gives a reliable hold on multi-core control cables, as well as on individual wires. This is a valuable advantage when critical equipment informations needs to be well positioned in order to be visible, even with extremely tight space constraints. It should be firmly fixed to wire and cable diameters from 1.5 to 7.5 mm.

### DMC – the benefits to you

- Clever: snap-fit mechanism for quick and secure application
- Versatile: can be attached to one or more connection wires
- Distinctive: a large labelling area gives you all the information at a glance



PrintJet CONNECT



Plotter MCP Plus 2

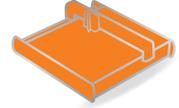

Plotter MCP Basic 2

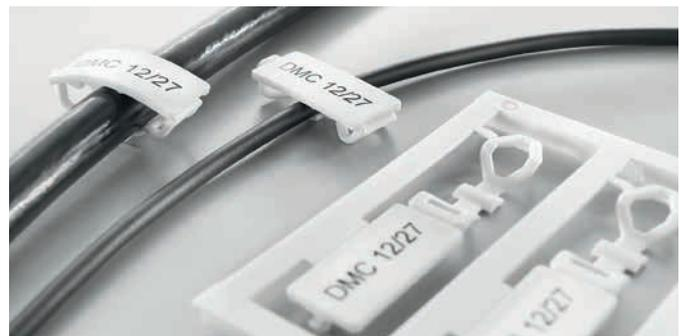

Simply and securely: the clip assembly onto wires with cross-sections from 0.5 to 10 mm<sup>2</sup>.

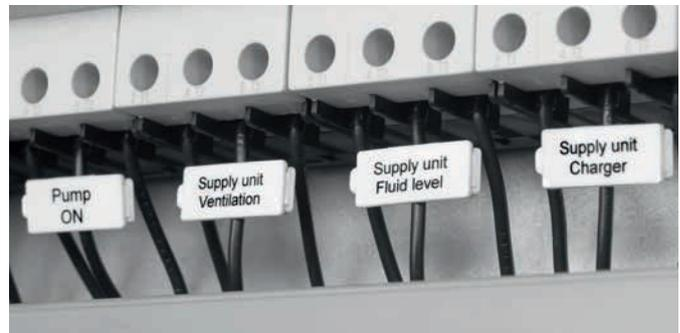

Creates space: equipment identification for clear additional information can be simply attached to wires or cables.



### Technical data

Material	Polyamide 66, halogen-free
UL 94 flammability rating	V2
Temperature range	-40 °C to 100 °C

### Ordering data

Colour	International colour code colours, not contained in the range, are available on request.
Special printing	Specify special printing and colours per using the M-Print® PRO software.
Printing	Black or colour
Possible printing systems	PrintJet CONNECT, PrintJet ADVANCED, MCP Plus 2, MCP Basic 2
Marking surface	12 x 27 mm
Suitable for cable diameters	1.5 - 7.5 mm
And wire cross-sections	0.5 - 10 mm <sup>2</sup>
Minimum order quantity	1 pack = 5 cards



Absolutely secure grip thanks to the snap-fitting and the flexible hinge assembly on the rear.

**DMC MultiCard**

**DMC 12/27**

**27 mm**



**Technical data**

Material	Polyamide 66
Fire class acc. to UL 94	V-2
Ambient temperature (operational)	-40 °C...100 °C
Outer diameter of the wire, min. / max.	1.5...7.5 mm
Wire cross-section, min. / max.	0.5...10 mm <sup>2</sup>
Width	27 mm
Height	12 mm
<b>Note</b>	

Material	Polyamide 66
Fire class acc. to UL 94	V-2
Ambient temperature (operational)	-40 °C...100 °C
Outer diameter of the wire, min. / max.	1.5...7.5 mm
Wire cross-section, min. / max.	0.5...10 mm <sup>2</sup>
Width	27 mm
Height	12 mm
<b>Note</b>	

**Ordering data**

<b>MultiCard Blank</b>	
yellow	●
white	○
<b>MultiCard custom printing</b>	
To customer specification	
<b>Note</b>	

Type	Qty.	Order No.
DMC 12/27 MC NE GE	50	1018190000
DMC 12/27 MC NE WS	50	1016030000
DMC 12/27 MC SDR	10	1038830000
Please send M-Print PRO file		

**Technical drawing / application**



# ESG MultiCard

## For independent manufacturer equipment identification

### More clarity thanks to the uniform marking matrix

You can solve the identification of independent manufacturer equipment with the uniform and systematically constructed ESG-type MultiCard range. The carefully matched components bring together equipment from different manufacturers strictly and systematically, in a uniform marking matrix, which is reinforced by the high-quality and brilliance of the PrintJet CONNECT printing. In this way you can create perfect clarity in the electrical cabinet at the highest level of professionalism. ESG-markers are available for equipment from the following manufacturers, including: ABB-Stotz, AEG, Beckhoff, Berneker & Rainer, Eaton-Moeller, Festo, Lumberg, Siemens and Telemecanique (Schneider Electric).

### ESG – the benefits to you

- **Manufacturer-independent:** for equipment from the best-known providers
- **Systematic:** perfectly matching marking components in one range
- **Compatible:** a suitable marker for every device
- **Time saving:** no pre-selection needed – fast installation procedures

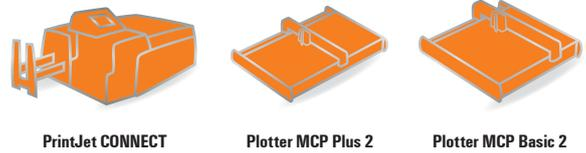

Individual signs of the ESG-range are compatible with our universal-use sign rails which are particularly suitable for rows of equipment and switches.



As well as snapping on, you can also fasten in place using the adhesive which provides an alternative method of securing and gives a secure attachment for every application.



#### Technical data

Material	Polyamide 66, halogen-free
UL 94 flammability rating	V2
Temperature range	-40 °C to 100 °C

#### Ordering data

Colour	International colour code colours, not contained in the range, are available on request.
Special printing	Specify special printing and colours per using the M-Print® PRO software.
Printing	Black or colour
Possible printing systems	PrintJet CONNECT, PrintJet ADVANCED, MCP Plus 2, MCP Basic 2
Not printable with	SMark Laser with self-adhesive markers
Minimum order quantity	1 pack = 5 cards



**ESG MultiCard**

**ESG 5/10**

**10 mm**

**ESG 6/15 K**

**15 mm**

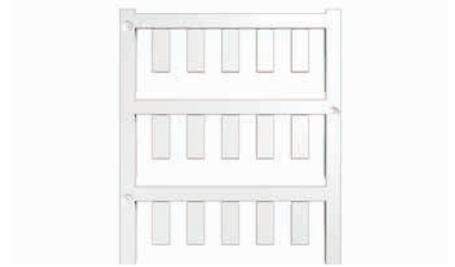

**Technical data**

Material
Fire class acc. to UL 94
Ambient temperature (operational)
Application/manufacturer
Width
Height
<b>Note</b>

PA 66
V-2
-40 °C...100 °C
Beckhoff, Turck, SAI distributor
10 mm
5 mm

PA 66
V-2
-40 °C...100 °C
Self-adhesive
15 mm
6 mm

**Ordering data**

<b>MultiCard Blank</b>
white <input type="radio"/>
yellow <input checked="" type="radio"/>
<b>MultiCard custom printing</b>
To customer specification
<b>Note</b>

Type	Qty.	Order No.
ESG 5/10 MC NE WS	400	<b>1919940000</b>
ESG 5/10 MC SDR	80	<b>1038840000</b>

Please send M-Print PRO file

Type	Qty.	Order No.
ESG 6/15 K MC NE WS	200	<b>1880100000</b>
ESG 6/15 K MC NE GE	200	<b>1880130000</b>
ESG 6/15 K MC SDR	40	<b>1880090000</b>

Please send M-Print PRO file

**Technical drawing / application**



ESG MultiCard – cross-manufacturer equipment identification

ESG MultiCard

ESG 6/15 F

15 mm

ESG 6/15 RIDERSERIES

15 mm



Technical data

Material
Fire class acc. to UL 94
Ambient temperature (operational)
Application/manufacturer
Width
Height
Note

PA 66
V-2
-40 °C...100 °C
Festo
15 mm
6 mm

PA 66
V-2
-40 °C...100 °C
Riderseries SCM/SRC
15 mm
6 mm

Ordering data

<b>MultiCard Blank</b>
white <input type="radio"/>
yellow <input checked="" type="radio"/>
<b>MultiCard custom printing</b>
To customer specification
Note

Type	Qty.	Order No.
ESG 6/15 F MC NE WS	200	1136810000
Please send M-Print PRO file		

Type	Qty.	Order No.
ESG 6/15 RIDER MC NE WS	200	1881280000
ESG 6/15 RIDER MC NE GE	200	1378710000
ESG 6/15 RIDER MC SDR	40	1881290000
Please send M-Print PRO file		

Technical drawing / application



**ESG MultiCard**

**ESG 6/17 K**

**17 mm**

**ESG 6.6/11**

**11 mm**



**Technical data**

Material
Fire class acc. to UL 94
Ambient temperature (operational)
Application/manufacturer
Width
Height
<b>Note</b>

PA 66
V-2
-40 °C...100 °C
Self-adhesive
17 mm
6 mm

PA 66
V-2
-40 °C...100 °C
BHZ, ACT 20
11 mm
6.6 mm

**Ordering data**

<b>MultiCard Blank</b>
white ○
yellow ●
<b>MultiCard custom printing</b>
To customer specification
<b>Note</b>

Type	Qty.	Order No.
ESG 6/17 K MC NE WS	200	<b>1880120000</b>
ESG 6/17 K MC NE GE	200	<b>1880110000</b>
ESG 6/17 K MC SDR	40	<b>1880080000</b>
Please send M-Print PRO file		

Type	Qty.	Order No.
ESG 6.6/11 BHZ 5.00/02	200	<b>1082490000</b>
ESG 6.6/11 BHZ 5.00 SDR	200	<b>1346330000</b>
Please send M-Print PRO file		

**Technical drawing / application**



ESG MultiCard – cross-manufacturer equipment identification

ESG MultiCard

ESG 6.6/15

15 mm

ESG 6.6/20

20 mm



Technical data

Material
Fire class acc. to UL 94
Ambient temperature (operational)
Application/manufacturer
Width
Height
<b>Note</b>

PA 66
V-2
-40 °C...100 °C
BHZ, ACT 20
15 mm
6.6 mm

PA 66
V-2
-40 °C...100 °C
BHZ, ACT 20
20 mm
6.6 mm

Ordering data

<b>MultiCard Blank</b>
white <input type="radio"/>
yellow <input type="radio"/>
<b>MultiCard custom printing</b>
To customer specification
<b>Note</b>

Type	Qty.	Order No.
ESG 6.6/15 BHZ 5.00/03	200	<b>1082520000</b>
ESG 6.6/15 BHZ 5.00 SDR	200	<b>1346320000</b>

Please send M-Print PRO file

Type	Qty.	Order No.
ESG 6.6/20 BHZ 5.00/04	200	<b>1082540000</b>
ESG 6.6/20 BHZ 5.00 SDR	40	<b>1221520000</b>

Please send M-Print PRO file

Technical drawing / application



**ESG MultiCard**

**ESG 7/20 Sirius**

**20 mm**

**ESG 8/10**

**10 mm**



**Technical data**

Material
Fire class acc. to UL 94
Ambient temperature (operational)
Application/manufacturer
Width
Height
<b>Note</b>

PA 66
V-2
-40 °C...100 °C
Siemens Sirius 3R
20 mm
7 mm

PA 66
V-2
-40 °C...100 °C
Siemens AS-Interface, ifm-electronics
10 mm
8 mm

**Ordering data**

<b>MultiCard Blank</b>
yellow ●
Turquoise ●
white ○
<b>MultiCard custom printing</b>
To customer specification
<b>Note</b>

Type	Qty.	Order No.
ESG 7/20 SIRIUS MC NE GE	200	1736181687
ESG 7/20 SIRIUS MC NE TU	200	1736181696
ESG 7/20 SIRIUS MC NE WS	200	1736181044
ESG 7/20 SIRIUS MC SDR	40	1766650000

Please send M-Print PRO file

Type	Qty.	Order No.
ESG 8/10 ASI MC NE WS	200	1736190000
ESG 8/10 ASI MC SDR	40	1770470000

Please send M-Print PRO file

**Accessories**

<b>Tag rail</b>
<b>Note</b>

Type	Qty.	Order No.
SCHS3 K	1	1753480000
SCHS4 K	1	1753460000

Type	Qty.	Order No.
------	------	-----------

**Technical drawing / application**



ESG MultiCard – cross-manufacturer equipment identification

ESG MultiCard

ESG 8/11

11 mm

ESG 8/13.5/43.3

13.5 mm



Technical data

Material
Fire class acc. to UL 94
Ambient temperature (operational)
Application/manufacturer
Width
Height
<b>Note</b>

PA 66
V-2
-40 °C...100 °C
Beckhoff, WAGO I/O Module
11 mm
8 mm

PA 66
V-2
-40 °C...100 °C
WI SAI ACTIVE
13.5 mm
8 mm

Ordering data

<b>MultiCard Blank</b>
white <input type="radio"/>
Transparent <input type="radio"/>
<b>MultiCard custom printing</b>
To customer specification
<b>Note</b>

Type	Qty.	Order No.
ESG 8/11 MC NE WS	200	<b>1897570000</b>
ESG 8/11 MC SDR	40	<b>1038850000</b>

Please send M-Print PRO file

Type	Qty.	Order No.
ESG 8/13.5/43.3 SAI AU	5	<b>1912130000</b>
ESG 8/13.5/43.3 SAI SDR	1	<b>1038860000</b>

Please send M-Print PRO file

Technical drawing / application



**ESG MultiCard**

**ESG 8/17**

**17 mm**

**ESG 8/17 L**

**17 mm**



**Technical data**

Material
Fire class acc. to UL 94
Ambient temperature (operational)
Application/manufacturer
Width
Height
<b>Note</b>

PA 66
V-2
-40 °C...100 °C
Telemecanique, ifm-electronics
17 mm
8 mm

PA 66
V-2
-40 °C...100 °C
Lumberg
17 mm
8 mm

**Ordering data**

<b>MultiCard Blank</b>
white <input type="radio"/>
Transparent <input type="radio"/>
<b>MultiCard custom printing</b>
To customer specification
<b>Note</b>

Type	Qty.	Order No.
ESG 8/17 MC NE WS	200	<b>1674740000</b>
ESG 8/17 MC SDR	40	<b>1674750000</b>

Please send M-Print PRO file

Type	Qty.	Order No.
ESG 8/17 L MC NE WS	200	<b>1890470000</b>
ESG 8/17 L MC SDR	40	<b>1038870000</b>

Please send M-Print PRO file

**Technical drawing / application**



ESG MultiCard – cross-manufacturer equipment identification

ESG MultiCard

ESG 8/17 SCHS

17 mm

ESG 8/17 SYS PRO

17 mm



Technical data

Material
Fire class acc. to UL 94
Ambient temperature (operational)
Application/manufacturer
Width
Height
Note

PA 66
V-2
-40 °C...100 °C
Tag rail SchS2
17 mm
8 mm

PA 66
V-2
-40 °C...100 °C
AEG, ABB-Stotz
17 mm
8 mm

Ordering data

<b>MultiCard Blank</b>
white ○
<b>MultiCard custom printing</b>
To customer specification
Note

Type	Qty.	Order No.
ESG 8/17 SCHS MC NE WS	200	1720610000
ESG 8/17 SCHS MC SDR	40	1766640000
Please send M-Print PRO file		

Type	Qty.	Order No.
ESG 8/17 SYS PRO M WS	200	1755340000
ESG 8/17 SYS PRO M SDR	40	1755350000
Please send M-Print PRO file		

Accessories

Note
------

Type	Qty.	Order No.
SCHS2 K	1	1720600000
SCHS2	1	0337400000

Type	Qty.	Order No.

Technical drawing / application





ESG 8/17 OF

17 mm



PA 66

V-2

-40 °C...100 °C

lfm-electronic AC5200

17 mm

8 mm

Type	Qty.	Order No.
ESG 8/17 OF MC NE WS	200	<b>2681860000</b>
ESG 8/17 OF MC SDR	40	<b>2682060000</b>
Please send M-Print PRO file		

C



ESG MultiCard – cross-manufacturer equipment identification

ESG MultiCard

ESG 8/19

19 mm

ESG 9/10

10 mm



Technical data

Material
Fire class acc. to UL 94
Ambient temperature (operational)
Application/manufacturer
Width
Height
Note

PA 66
V-2
-40 °C...100 °C
AEG
19 mm
8 mm

PA 66
V-2
-40 °C...100 °C
10 mm
9 mm

Ordering data

<b>MultiCard Blank</b>
white <input type="radio"/>
yellow <input type="radio"/>
<b>MultiCard custom printing</b>
To customer specification
Note

Type	Qty.	Order No.
ESG 8/19 MC NE WS	200	1652220000
ESG 8/19 MC SDR	40	1652230000

Please send M-Print PRO file

Type	Qty.	Order No.
ESG 9/10 MC NE WS	200	1775910000
ESG 9/10 MC SDR	40	1038880000

Please send M-Print PRO file

Technical drawing / application



**ESG MultiCard**

**ESG 9/11 K**

**11 mm**

**ESG 9/17.7 K**

**17.7 mm**



**Technical data**

Material
Fire class acc. to UL 94
Ambient temperature (operational)
Application/manufacturer
Width
Height
<b>Note</b>

PA 66
V-2
-40 °C...100 °C
Self-adhesive
11 mm
9 mm

PA 66
V-2
-40 °C...100 °C
LS switch, Self-adhesive
17.7 mm
9 mm

**Ordering data**

<b>MultiCard Blank</b>
white <input type="radio"/>
yellow <input type="radio"/>
<b>MultiCard custom printing</b>
To customer specification
<b>Note</b>

Type	Qty.	Order No.
ESG 9/11 K MC NE WS	200	<b>1857440000</b>
ESG 9/11 K MC SDR	40	<b>1857450000</b>
Please send M-Print PRO file		

Type	Qty.	Order No.
ESG 9/17.7 K MC NE WS	180	<b>2047430000</b>
ESG 9/17.7 K MC SDR	36	<b>2047550000</b>
Please send M-Print PRO file		

**Technical drawing / application**



ESG MultiCard – cross-manufacturer equipment identification

ESG MultiCard

ESG 9/17

17 mm

ESG 9/17 K

17 mm



Technical data

Material
Fire class acc. to UL 94
Ambient temperature (operational)
Application/manufacturer
Width
Height
Note

PA 66
V-2
-40 °C...100 °C
CLI TM sleeve
17 mm
9 mm

PA 66
V-2
-40 °C...100 °C
Self-adhesive
17 mm
9 mm

Ordering data

<b>MultiCard Blank</b>
white <input type="radio"/>
yellow <input checked="" type="radio"/>
<b>MultiCard custom printing</b>
To customer specification
Note

Type	Qty.	Order No.
ESG 9/17 MC NE WS	200	1724760000
ESG 9/17 MC SDR	40	1770480000

Please send M-Print PRO file

Type	Qty.	Order No.
ESG 9/17 K MC NE WS	200	1674760000
ESG 9/17 K MC NE GE	200	1753500000
ESG 9/17 K MC SDR	40	1674770000

Please send M-Print PRO file

Technical drawing / application



**ESG MultiCard**

**ESG 9/20**

20 mm

**ESG 9/20 L**

20 mm



**Technical data**

Material
Fire class acc. to UL 94
Ambient temperature (operational)
Application/manufacturer
Width
Height
<b>Note</b>

PA 66
V-2
-40 °C...100 °C
Siemens, Moeller, WI SAI distributor, ifm-electronics
20 mm
9 mm

PA 66
V-2
-40 °C...100 °C
Lumberg
20 mm
9 mm

**Ordering data**

<b>MultiCard Blank</b>
yellow ●
Turquoise ●
white ○
<b>MultiCard custom printing</b>
To customer specification
<b>Note</b>

Type	Qty.	Order No.
ESG 9/20 MC NE GE	200	<b>1766160000</b>
ESG 9/20 MC NE TK	200	<b>1866690000</b>
ESG 9/20 MC NE WS	200	<b>1609940000</b>
ESG 9/20 MC SDR	40	<b>1609950000</b>

Please send M-Print PRO file

Type	Qty.	Order No.
ESG 9/20 L MC NE GE	200	<b>1010860000</b>
ESG 9/20 L MC NE WS	200	<b>1890460000</b>
ESG 9/20 L MC SDR	40	<b>1968140000</b>

Please send M-Print PRO file

**Technical drawing / application**







ESG MultiCard – cross-manufacturer equipment identification

ESG MultiCard

ESG X20 10/7

7 mm

ESG B&R X20

10 mm



Technical data

Material
Fire class acc. to UL 94
Ambient temperature (operational)
Application/manufacturer
Width
Height
Note

PA 66
V-2
-40 °C...100 °C
B&R X20 System
7 mm
10 mm

PA 66
V-2
-40 °C...100 °C
B&R X20 System
10 mm
2.5 mm

Ordering data

<b>MultiCard Blank</b>
white <input type="radio"/>
blue <input type="radio"/>
orange <input type="radio"/>
red <input type="radio"/>
yellow <input type="radio"/>
grey <input type="radio"/>
<b>MultiCard custom printing</b>
To customer specification
Note

Type	Qty.	Order No.
ESG X20 10/7 MC NE WS	240	1026550000
ESG X20 10/7 MC NE BL	240	1026560000
ESG X20 10/7 MC NE OR	240	1026580000
ESG X20 10/7 MC NE RT	240	1026570000
ESG X20 10/7 MC SDR	48	1038930000

Please send M-Print PRO file

Type	Qty.	Order No.
ESG X20 MC NE WS	1120	1001140001
ESG X20 MC NE BL	1120	1001150001
ESG X20 MC NE OR	1120	1001160001
ESG X20 MC NE RT	1120	1001170001
ESG X20 MC SDR	1120	1038890000

Please send M-Print PRO file

Technical drawing / application





**ESG MultiCard**

**ESG 15/10**

**15 mm**

**ESG 9/26 SCM ECO**

**26 mm**



**Technical data**

Material
Fire class acc. to UL 94
Ambient temperature (operational)
Application/manufacturer
Width
Height
<b>Note</b>

PA 66
V-2
-40 °C...100 °C
Siemens ET 200SP
15 mm
10 mm

PA 66
V-2
-40 °C...100 °C
Weidmüller, D-Series 27 mm
26 mm
9 mm

**Ordering data**

<b>MultiCard Blank</b>
white <input type="radio"/>
blue <input type="radio"/>
orange <input type="radio"/>
red <input type="radio"/>
yellow <input type="radio"/>
grey <input type="radio"/>
<b>MultiCard custom printing</b>
To customer specification
<b>Note</b>

Type	Qty.	Order No.
ESG 15/10 MC NE WS	160	<b>2047360000</b>
ESG 15/10 MC SDR	32	<b>2047540000</b>
Please send M-Print PRO file		

Type	Qty.	Order No.
ESG 9/26 SCM ECO MC NE WS	80	<b>1520980000</b>
ESG 9/26 SCM ECO MC NE GE	80	<b>1520990000</b>
ESG 9/26 SCM ECO MC NE GR	80	<b>1521000000</b>
ESG 9/26 SCM ECO MC SDR	80	<b>1525800000</b>
Please send M-Print PRO file		

**Technical drawing / application**





**ESG MultiCard**

**ESG-FI 12/6**

**6 mm**

**ESG-FI 9/15**

**15 mm**



**Technical data**

Material
Fire class acc. to UL 94
Ambient temperature (operational)
Application/manufacturer
Width
Height
<b>Note</b>

PA 66
V-2
-40 °C...100 °C
Finder
6 mm
12 mm

PA 66
V-2
-40 °C...100 °C
Finder
15 mm
9 mm

**Ordering data**

<b>MultiCard Blank</b>
white <input type="radio"/>
<b>MultiCard custom printing</b>
To customer specification
<b>Note</b>

Type	Qty.	Order No.
ESG-FI 12/6 MC NE WS	400	<b>2681820000</b>
ESG-FI 12/6 MC SDR	80	<b>2681910000</b>
Please send M-Print PRO file		

Type	Qty.	Order No.
ESG-FI 9/15 MC NE WS	200	<b>2681830000</b>
ESG-FI 9/15 MC SDR	40	<b>2681960000</b>
Please send M-Print PRO file		

**Technical drawing / application**



**ESG MultiCard – cross-manufacturer equipment identification**

**ESG MultiCard**

**ESG-FI 9/25**

**25 mm**



**Technical data**

Material
Fire class acc. to UL 94
Ambient temperature (operational)
Application/manufacturer
Width
Height
<b>Note</b>

PA 66
V-2
-40 °C...100 °C
Finder
25 mm
9 mm

**Ordering data**

<b>MultiCard Blank</b>
white <span style="float: right;">○</span>
<b>MultiCard custom printing</b>
To customer specification
<b>Note</b>

Type	Qty.	Order No.
ESG-FI 9/25 MC NE WS	64	<b>2681850000</b>
ESG-FI 9/25 MC SDR	16	<b>2682010000</b>
Please send M-Print PRO file		

**Technical drawing / application**





# SM – SwitchMark MultiCard

## Exemplary functional marking for control and signalling devices

### Equipment-specific labelling for safe control

To avoid incorrect operation, clear identification is essential when controlling the functions of control and signalling devices. Designed specifically to meet this need, the SwitchMark system covers the entire range of requirements of the respective application areas. The signs are snapped into the holders designed for the different manufacturers' control and signalling devices or fastened in place using the adhesive tape that has been applied previously. Alternatively, choose a set containing both holders and signs. Even for the many variations in cam-switch positions, the SwitchMark range contains the appropriately shaped signs for accurate labelling. Combined with Weidmüller's marking systems, you can print the signs independently and as required for the application in an individual layout – including all the relevant additional information.



### SwitchMark – the benefits to you

- Practical: signs for various device manufacturers or holders with shields from Weidmüller in a set
- Easy to install: glue or snap in place
- Individual: application-precise in terms of number and labelling
- Cost efficient: no need to store standard signs

Holders and signs are available in sets in the most common sizes and versions for control and signalling devices from Siemens (type 35B) or ABB (type ONFB72).



You can use the SwitchMark system-solution to cover a variety of cam controllers from various manufacturers.



#### Technical data

Material	Polyamide 66, halogen-free
UL 94 flammability rating	V2
Temperature range	-40 °C to 100 °C

#### Technical data detectable markers

Material	Polyamide 66, halogen-free
UL 94 flammability rating	HB
Temperature range	-40 °C to 100 °C

#### Ordering data

Colour	International colour code colours, not contained in the range, are available on request.
Special printing	Specify special printing and colours per using the M-Print® PRO software.
Printing	Black or colour
Possible printing systems	PrintJet CONNECT, PrintJet ADVANCED, MCP Plus 2, MCP Basic 2
Not printable with	SMark Laser with self-adhesive markers
Minimum order quantity	1 pack = 5 cards







SwitchMark MultiCard

SM 27/12.5

27 mm

SM 27/18

27 mm



Technical data

Material
Fire class acc. to UL 94
Ambient temperature (operational)
Application/manufacturer
Width
Height
Note

Polyamide 66
V-2
-40 °C...100 °C
27 mm
12.5 mm

Polyamide 66
V-2
-40 °C...100 °C
27 mm
18 mm

Ordering data

<b>MultiCard Blank</b>	
yellow	●
grey	●
silver	●
white	○
green	●
red	●
blue	●
<b>MultiCard custom printing</b>	
To customer specification	
blue	●
<b>MultiCard Blank, self adhesive</b>	
yellow	●
grey	●
white	○
silver	●
red	●
blue	●
<b>MultiCard Blank, self adhesive, custom printing</b>	
To customer specification	
Note	

Type	Qty.	Order No.
SM 27/12.5 MC NE GE	80	1131860000
SM 27/12.5 MC NE GR	80	1079490000
SM 27/12.5 MC NE SI	80	1713700000
SM 27/12.5 MC NE WS	80	1699840000
SM 27/12.5 SDR	16	1699850000
SM 27/12.5 K MC NE GE	80	1131810000
SM 27/12.5 K MC NE GR	80	1027830000
SM 27/12.5 K MC NE WS	80	1699880000
SM 27/12.5 K MC NE SI	80	1713720000
SM 27/12.5 K MC SDR	16	1699890000
Please send M-Print PRO file		

Type	Qty.	Order No.
SM 27/18 MC NE GE	80	1131850000
SM 27/18 MC NE GR	80	1014640000
SM 27/18 MC NE SI	80	1713740000
SM 27/18 MC NE WS	80	1699860000
SM 27/18 MC NE GN	80	1346130000
SM 27/18 MC NE RT	80	1906110000
SM 27/18 MC SDR	16	1699870000
SM 27/18 K MC NE GE	80	1915340000
SM 27/18 K MC NE GR	80	1073340000
SM 27/18 K MC NE WS	80	1707270000
SM 27/18 K MC NE SI	80	1713760000
SM 27/18 K MC NE RT	80	1906120000
SM 27/18 K MC SDR	16	1707280000
Please send M-Print PRO file		

Accessories

<b>Protective film</b>
<b>Holder</b>
<b>Note</b>

Type	Qty.	Order No.
ETO SM 27/12,5	10	1720580000
SM-H 27/12.5 SW	25	1716640000

Type	Qty.	Order No.
ETO SM 27/18 TRANSPAR.	10	1720590002
SM-H 27/18 SW	25	1716630000

Technical drawing / application



**SM MultiCard – marker system for control and signalling devices**

**SwitchMark MultiCard**

**SM 27/27**

**27 mm**



**SM-DT 27/27**

**27 mm**

**Detectable marker**

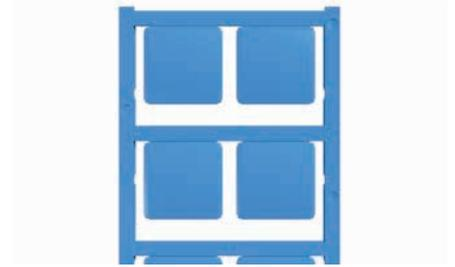

**Technical data**

Material
Fire class acc. to UL 94
Ambient temperature (operational)
Application/manufacturer
Width
Height
<b>Note</b>

Polyamide 66
V-2
-40 °C...100 °C
Application/manufacturer
Width
Height
<b>Note</b>

Polyamide 66
HB
-40 °C...100 °C
Application/manufacturer
Width
Height
<b>Note</b>

**Ordering data**

<b>MultiCard Blank</b>	
yellow	●
grey	●
silver	●
white	○
green	●
red	●
blue	●
<b>MultiCard custom printing</b>	
To customer specification	
blue	●
<b>MultiCard Blank, self adhesive</b>	
yellow	●
grey	●
white	○
silver	●
red	●
blue	●
<b>MultiCard Blank, self adhesive, custom printing</b>	
To customer specification	
<b>Note</b>	

Type	Qty.	Order No.
SM 27/27 MC NE GE	60	1131840000
SM 27/27 MC NE GR	60	1079510000
SM 27/27 MC NE SI	60	1773230000
SM 27/27 MC NE WS	60	1773220000
<b>MultiCard custom printing</b>		
To customer specification		
SM 27/27 MC SDR	12	1773240000
<b>MultiCard Blank, self adhesive</b>		
SM 27/27 K MC NE GE	60	1131800000
SM 27/27 K MC NE GR	60	1079520000
SM 27/27 K MC NE WS	60	1783000000
SM 27/27 K MC NE SI	60	1782990000
<b>MultiCard Blank, self adhesive, custom printing</b>		
To customer specification		
SM 27/27 K MC SDR	12	1783010000
<b>Note</b>		
Please send M-Print PRO file		

Type	Qty.	Order No.
SM-DT 27/27 MC NE BL	60	2737780000
SM-DT-H 27/27 BL	10	2737800000
SM-DT 27/27 K MC NE BL	60	2737790000
<b>Note</b>		
Please send M-Print PRO file		

**Accessories**

<b>Protective film</b>
<b>Holder</b>
<b>Note</b>

Type	Qty.	Order No.
ETO SM 27/27	10	1805840000
SM-H 27/27 SW	10	1782710000
<b>Note</b>		

**Technical drawing / application**



SwitchMark MultiCard

SM 37.5/17

37.5 mm

SM 27/18-22

27 mm



Technical data

Material
Fire class acc. to UL 94
Ambient temperature (operational)
Application/manufacturer
Width
Height
Note

Polyamide 66
V-2
-40 °C...100 °C
37.5 mm
17 mm

Polyamide 66
V-2
-40 °C...100 °C
27 mm
53.75 mm

Ordering data

MultiCard Blank	
yellow	●
grey	●
silver	●
white	○
green	●
red	●
blue	●
MultiCard custom printing	
To customer specification	
blue	●
MultiCard Blank, self adhesive	
yellow	●
grey	●
white	○
silver	●
red	●
blue	●
MultiCard Blank, self adhesive, custom printing	
To customer specification	
Note	

Type	Qty.	Order No.
SM 37.5/17 MC NE GR	40	1336720000
SM 37.5/17 MC NE WS	40	1336710000
SM 37.5/17 MC SDR	8	1336680000
Please send M-Print PRO file		

Type	Qty.	Order No.
SM 27/18-22 K MC NE GR	40	1428180000
SM 27/18-22 K MC NE WS	40	1428170000
SM 27/18-22 K MC SDR	8	1433870000
Please send M-Print PRO file		

Technical drawing / application





SwitchMark MultiCard

SM 44/44-21

44 mm

SM 45/45-24

45 mm

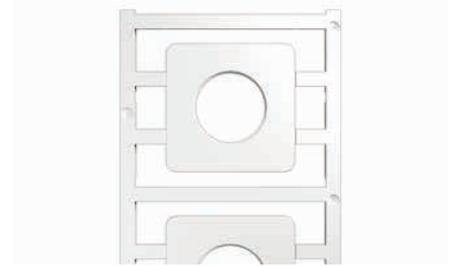
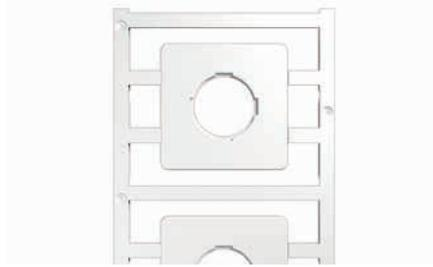

Technical data

Material
Fire class acc. to UL 94
Ambient temperature (operational)
Application/manufacturer
Width
Height
Note

Polyamide 66
V-2
-40 °C...100 °C
for cam switches, ABB, Type ON and OL40
44 mm
44 mm

Polyamide 66
V-2
-40 °C...100 °C
for cam switches, Eaton Moeller
45 mm
45 mm

Ordering data

<b>MultiCard Blank</b>	
yellow	●
grey	●
silver	●
white	○
green	●
red	●
blue	●
<b>MultiCard custom printing</b>	
To customer specification	
blue	●
<b>MultiCard Blank, self adhesive</b>	
yellow	●
grey	●
white	○
silver	●
red	●
blue	●
<b>MultiCard Blank, self adhesive, custom printing</b>	
To customer specification	
Note	

Type	Qty.	Order No.
SM 44/44-21 MC NE GE	20	1323580000
SM 44/44-21 MC NE GR	20	1323600000
SM 44/44-21 MC NE WS	20	1323570000
SM 44/44-21 MC SDR	4	1323640000

Please send M-Print PRO file

Type	Qty.	Order No.
SM 45/45-24 MC NE GE	20	1248660000
SM 45/45-24 MC NE GR	20	1248670000
SM 45/45-24 MC NE WS	20	1248650000
SM 45/45-24 MC SDR	4	1248570000

Please send M-Print PRO file

Technical drawing / application



**SM MultiCard – marker system for control and signalling devices**

**SwitchMark MultiCard**

**SM 46/46-30**

**46 mm**

**SM DIA 60-22**

**60 mm**

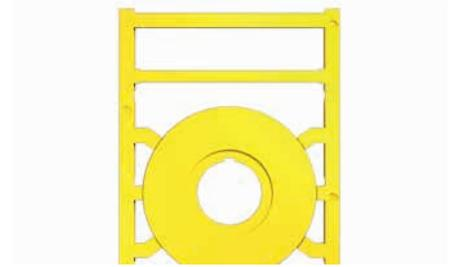
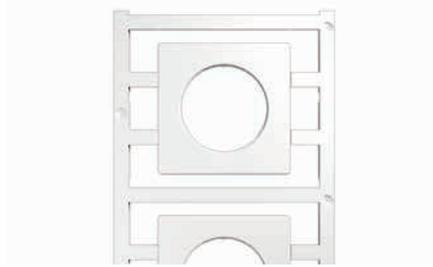

**Technical data**

Material
Fire class acc. to UL 94
Ambient temperature (operational)
Application/manufacturer
Width
Height
Note

Polyamide 66
V-2
-40 °C...100 °C
for cam switches, Type S0, Kraus & Naimer
46 mm
46 mm

Polyamide 66
V-2
-40 °C...100 °C
ø 60 - 22 mm, Siemens 3 SB, Eaton Moeller M22-PV
60 mm
60 mm

**Ordering data**

<b>MultiCard Blank</b>	
yellow	●
grey	●
silver	●
white	○
green	●
red	●
blue	●
<b>MultiCard custom printing</b>	
To customer specification	
blue	●
<b>MultiCard Blank, self adhesive</b>	
yellow	●
grey	●
white	○
silver	●
red	●
blue	●
<b>MultiCard Blank, self adhesive, custom printing</b>	
To customer specification	
Note	

Type	Qty.	Order No.
SM 46/46-30 MC NE GE	20	1323510000
SM 46/46-30 MC NE GR	20	1323520000
SM 46/46-30 MC NE WS	20	1323500000
SM 46/46-30 MC SDR	4	1323610000
Please send M-Print PRO file		

Type	Qty.	Order No.
SM DIA 60-22 K MC NE GE	10	1323750000
SM DIA 60-22 MC SDR	2	1323740000
Please send M-Print PRO file		

**Technical drawing / application**

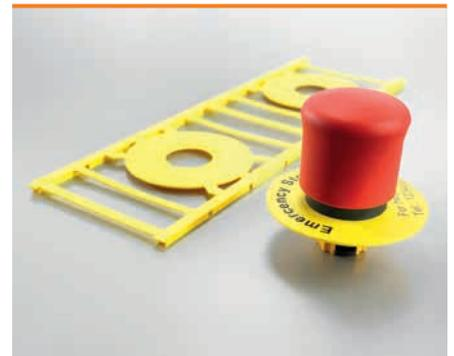



# CC – ClipCard MultiCard

## The alternative to engraved device markers

### Brilliant printing results without of high costs

With its crisply printed labelling area in various sizes, the multi-functional ClipCard is on an equal footing with engraved device markers. Mounted at eye-level, it is the ideal alternative for marking electrical installations and switching facilities, and uses the full range of attachment types.

From simple device identification through to the labelling of pipework, valves, motors or lamps in accordance with DIN V VDE V 0108 (part 100), or creating nameplates with a colour firm logo, you cover the entire marking requirements reliably and cost-efficiently with the ClipCard range.

### ClipCard – the benefits to you

- Economic: highly resistant labelling in engraved quality
- Easy to install: all types of attachment in one format
- Comprehensive: a wide range of applications thanks to the variety of sizes and design options

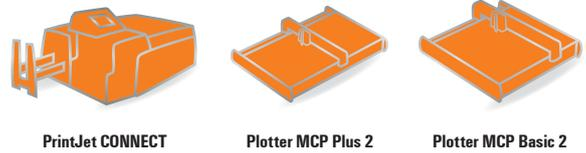

The signs are pre-drilled or have double-sided adhesive tape attached giving you tremendous time savings during installation.



There are matching holders for additional mounting possibilities: snap-locking or using cable ties.



### Technical data

Material	Polyamide 66, halogen-free
UL 94 flammability rating	V2
Temperature range	-40 °C to 100 °C
Temperature range	-40 °C to 60 °C (self-adhesive)
Approved air humidity	Max. 60 %, only for screwable markers

### Technical data detectable markers

Material	Polyamide 66, halogen-free
UL 94 flammability rating	HB
Temperature range	-40 °C to 100 °C

### Ordering data

Colour	International colour code colours, not contained in the range, are available on request.
Special printing	Specify special printing and colours per using the M-Print® PRO software.
Printing	Black or colour
Possible printing systems	PrintJet CONNECT, PrintJet ADVANCED, MCP Plus 2, MCP Basic 2
Not printable with	SMark Laser with self-adhesive markers
Minimum order quantity	1 pack = 5 cards

C



ClipCard MultiCard

CC 15/17

17 mm

CC 15/27

27 mm



Technical data

Material	Polyamide 66
Fire class acc. to UL 94	V-2
Ambient temperature (operational)	Standard: -40...100 °C; Self adhesive: -40...60 °C
Application/manufacturer	Holder CC-H 15/17
Width	17 mm
Height	15 mm
<b>Note</b>	

Material	Polyamide 66
Fire class acc. to UL 94	V-2
Ambient temperature (operational)	Standard: -40...100 °C; Self adhesive: -40...60 °C
Application/manufacturer	Holder CC-H 15/27
Width	27 mm
Height	15 mm
<b>Note</b>	

Material	Polyamide 66
Fire class acc. to UL 94	V-2
Ambient temperature (operational)	Standard: -40...100 °C; Self adhesive: -40...60 °C
Application/manufacturer	Holder CC-H 15/27
Width	27 mm
Height	15 mm
<b>Note</b>	

Ordering data

<b>MultiCard Blank</b>	
white	○
yellow	●
grey	●
silver	●
blue	●
green	●
red	●
<b>MultiCard custom printing</b>	
To customer specification	
<b>MultiCard Blank, self adhesive</b>	
yellow	●
grey	●
red	●
silver	●
white	○
blue	●
<b>MultiCard Blank, self adhesive, custom printing</b>	
To customer specification	
<b>Note</b>	

Type	Qty.	Order No.
CC 15/17 MC NE WS	80	1876570000
CC 15/17 MC NE GE	80	1131930000
CC 15/17 MC NE GR	80	1079530000
CC 15/17 MC NE SI	80	1876610000
CC 15/17 MC SDR	16	1876620000
CC 15/17 K MC NE GE	80	1131920000
CC 15/17 K MC NE GR	80	1079540000
CC 15/17 K MC NE RT	80	1288320000
CC 15/17 K MC NE SI	80	1876580000
CC 15/17 K MC NE WS	80	1876590000
CC 15/17 K MC SDR	16	1876600000
1876770000 - CC 15/27 MC NE WS: Suitable for CD-LBH		

Type	Qty.	Order No.
CC 15/27 MC NE WS	80	1876770000
CC 15/27 MC NE GE	80	1131940000
CC 15/27 MC NE GR	80	1079550000
CC 15/27 MC NE SI	80	1876760000
CC 15/27 MC SDR	16	1876630000
CC 15/27 K MC NE GE	80	1131910000
CC 15/27 K MC NE GR	80	1079560000
CC 15/27 K MC NE RT	80	1288330000
CC 15/27 K MC NE SI	80	1876780000
CC 15/27 K MC NE WS	80	1876640000
CC 15/27 K MC SDR	16	1876750000
1876770000 - CC 15/27 MC NE WS: Suitable for CD-LBH		

Accessories

<b>Note</b>
-------------

Type	Qty.	Order No.
ETO CC 15/17 TRANSPAR.	10	1880850000
STR CC 15/17 TRANSPARENT	80	1888310000
CC-H 15/17	75	1790430000

Type	Qty.	Order No.
ETO CC 15/27 TRANSPAR.	10	1880810000
STR CC 15/27 TRANSPARENT	80	1888290000
CC-H 15/27	45	1790410000

Technical drawing / application





ClipCard MultiCard

CC 15/60

60 mm

CC 15/60 04MM

60 mm



Technical data

Material	Polyamide 66
Fire class acc. to UL 94	V-2
Ambient temperature (operational)	Standard: -40...100 °C; Self adhesive: -40...60 °C
Application/manufacturer	Holder CC-H 15/60
Width	60 mm
Height	15 mm
<b>Note</b>	

Material	Polyamide 66
Fire class acc. to UL 94	V-2
Ambient temperature (operational)	Standard: -40...100 °C
Application/manufacturer	Holder CC-H 15/60
Width	60 mm
Height	15 mm
<b>Note</b>	

Material	Polyamide 66
Fire class acc. to UL 94	V-2
Ambient temperature (operational)	Standard: -40...100 °C
Application/manufacturer	Holder CC-H 15/60
Width	60 mm
Height	15 mm
<b>Note</b>	

Ordering data

<b>MultiCard Blank</b>	
white	○
yellow	●
grey	●
silver	●
blue	●
green	●
red	●
<b>MultiCard custom printing</b>	
To customer specification	
<b>MultiCard Blank, self adhesive</b>	
yellow	●
grey	●
red	●
silver	●
white	○
blue	●
<b>MultiCard Blank, self adhesive, custom printing</b>	
To customer specification	
<b>Note</b>	

Type	Qty.	Order No.
CC 15/60 MC NE WS	40	1877350000
CC 15/60 MC NE GE	40	1131960000
CC 15/60 MC NE GR	40	1072640000
CC 15/60 MC NE SI	40	1877340000
CC 15/60 MC SDR	8	1877300000
CC 15/60 K MC NE GE	40	1131890000
CC 15/60 K MC NE GR	40	1072650000
CC 15/60 K MC NE RT	40	1288340000
CC 15/60 K MC NE SI	40	1877360000
CC 15/60 K MC NE WS	40	1877310000
CC 15/60 K MC SDR	8	1877320000
1876770000 - CC 15/27 MC NE WS: Suitable for CD-LBH		

Type	Qty.	Order No.
CC 15/60 04MM MC NE WS	40	1057580000
CC 15/60 04MM MC NE GE	40	1131880000
CC 15/60 04MM MC NE GR	40	1304060000
CC 15/60 04MM MC NE SI	40	1059990000
CC 15/60 04MM MC SDR	8	1060010000
Please send M-Print PRO file		

Accessories

<b>Type</b>	<b>Qty.</b>	<b>Order No.</b>
ETO CC 15/60 TRANSPAR.	10	1880840000
STR CC 15/60 TRANSPARENT	40	1888280000
CC-H 15/60	25	1878910000
<b>Note</b>		

<b>Type</b>	<b>Qty.</b>	<b>Order No.</b>
ETO CC 15/60 TRANSPAR.	10	1880840000
STR CC 15/60 TRANSPARENT	40	1888280000
CC-H 15/60	25	1878910000
<b>Note</b>		

<b>Type</b>	<b>Qty.</b>	<b>Order No.</b>
STR CC 15/60 TRANSPARENT	40	1888280000
<b>Note</b>		

Technical drawing / application



CC MultiCard – identification of electrical installations and switchgear

ClipCard MultiCard

CC 30/60

60 mm



CC-DT 30/60

60 mm

Detectable marker



Technical data

Material
Fire class acc. to UL 94
Ambient temperature (operational)
Application/manufacturer
Width
Height
Note

Polyamide 66
V-2
Standard: -40...100 °C; Self adhesive: -40...60 °C
Holder CC-H 30/60
60 mm
30 mm

Polyamide 66
HB
Standard: -40...100 °C; Self adhesive: -40...60 °C
60 mm
30 mm

Ordering data

<b>MultiCard Blank</b>	
white	○
yellow	●
grey	●
silver	●
blue	●
green	●
red	●
<b>MultiCard custom printing</b>	
To customer specification	
<b>MultiCard Blank, self adhesive</b>	
yellow	●
grey	●
red	●
silver	●
white	○
blue	●
<b>MultiCard Blank, self adhesive, custom printing</b>	
To customer specification	
Note	

Type	Qty.	Order No.
CC 30/60 MC NE WS	30	1934420000
CC 30/60 MC NE GE	30	1009320000
CC 30/60 MC NE GR	30	1072670000
CC 30/60 MC NE SI	30	1934400000
CC 30/60 MC SDR	6	1934410000
CC 30/60 K MC NE GE	30	1078320000
CC 30/60 K MC NE GR	30	1072680000
CC 30/60 K MC NE RT	30	1085430000
CC 30/60 K MC NE SI	30	1934330000
CC 30/60 K MC NE WS	30	1934390000
CC 30/60 K MC SDR	6	1934370000
Please send M-Print PRO file		

Type	Qty.	Order No.
CC-DT 30/60 MC NE BL	30	2737720000
CC-DT 30/60 K MC NE BL	30	2737730000

Accessories

Note
------

Type	Qty.	Order No.
ETO CC 30/60 TRANSPAR.	10	1934440000
STR CC 30/60 TRANSPARENT	10	1934450000
CC-H 30/60	10	1934430000

Technical drawing / application



ClipCard MultiCard

CC 30/60 04MM

60 mm

CC 85/27

85 mm



Technical data

Material	Polyamide 66
Fire class acc. to UL 94	V-2
Ambient temperature (operational)	Standard: -40...100 °C
Application/manufacturer	With hole
Width	60 mm
Height	30 mm
<b>Note</b>	

Material	Polyamide 66
Fire class acc. to UL 94	V-2
Ambient temperature (operational)	Standard: -40...100 °C; Self adhesive: -40...60 °C
Application/manufacturer	With hole
Width	85 mm
Height	27 mm
<b>Note</b>	

Ordering data

<b>MultiCard Blank</b>	
white	○
yellow	●
grey	●
silver	●
blue	●
green	●
red	●
<b>MultiCard custom printing</b>	
To customer specification	
<b>MultiCard Blank, self adhesive</b>	
yellow	●
grey	●
red	●
silver	●
white	○
blue	●
<b>MultiCard Blank, self adhesive, custom printing</b>	
To customer specification	
<b>Note</b>	

Type	Qty.	Order No.
CC 30/60 04MM MC NE WS	30	1083150000
CC 30/60 04MM MC NE GE	30	1083160000
CC 30/60 04MM MC NE GR	30	1083170000
CC 30/60 04MM MC NE BL	30	1158840000
CC 30/60 04MM MC NE GN	30	1158820000
CC 30/60 04MM MC NE RT	30	1158830000
CC 30/60 04MM MC SDR	6	1083190000
<b>Note</b>		
Please send M-Print PRO file		

Type	Qty.	Order No.
CC 85/27 MC NE WS	20	1520930000
CC 85/27 MC NE GE	20	1520940000
CC 85/27 MC NE GR	20	1520970000
CC 85/27 MC SDR	4	1525850000
CC 85/27 K MC NE GE	20	1526120000
CC 85/27 K MC NE GR	20	1526130000
CC 85/27 K MC NE SI	20	2123070000
CC 85/27 K MC NE WS	20	1526100000
CC 85/27 K MC SDR	20	1526140000
<b>Note</b>		
Please send M-Print PRO file		

Accessories

Type	Qty.	Order No.
<b>Note</b>		

Type	Qty.	Order No.
<b>Note</b>		

Type	Qty.	Order No.
CC-H 85/27 GR	40	1675130002
CC-H 85/27 SW	40	1675130001
<b>Note</b>		

Technical drawing / application













# Individual processing

## The professional system for every standard



PrintJet CONNECT

### Superior components in a comprehensive product line

Our labelling system allows you to label with precision and speed – without losing track.

Our completely matched line of materials, sizes and mounting options cover solutions for all of your particular operational needs.

The systematic use of PrintJet CONNECT and the M-Print®-PRO-software enables you to custom design and process facility labelling for all of your system components. The result is a consistently outstanding marking system.



### The benefits for you

- Quality: durable materials for extreme conditions
- Customised: perfectly matched system components provide the best variety
- Efficient: tailor-made solutions from a single source
- Professional: in-house control of all marking processes

PrintJet CONNECT enables you to print MetalliCards as standard.



Precise colour printing across multiple tags of the same type – thanks to an inlay-secured printing process.



The universal inlay is designed to accept eight different tag types and is particularly suitable for printing small batch jobs.

### Technical data

Tag material	Micro etching steel 1.4301 (ST) or chromal coated aluminium (AL)
Temperature range	-55 °C to +130 °C
Thickness	0.5 mm
Primer	100 impregnated cloths and hermetically sealed
Possible printing systems	PrintJet CONNECT, PrintJet ADVANCED

MetalliCard

CC-M 27/18

18 mm

CC-M 27/18 2X3

18 mm



Technical data

Ambient temperature (operational)
Width
Height
Drill-hole diameter
Diameter
Labelling field
<b>Note</b>

-55 °C...130 °C
18 mm
26.8 mm
25 x 15 mm

-55 °C...130 °C
18 mm
26.8 mm
3.30 mm
25 x 15 mm

Ordering data

<b>MetalliCard Blank</b>
Micro-etched stainless steel 1.4301 (ST)
Chrome coated aluminium (AL)
<b>MetalliCard custom printing</b>
Micro-etched stainless steel 1.4301 (ST)
Chrome coated aluminium (AL)
<b>Note</b>

Type	Qty.	Order No.
CC-M 27/18 ST	200	1327640000
CC-M 27/18 AL	200	1327630000
CC-M 27/18 ST SDR	1	1474120000
CC-M 27/18 AL SDR	1	1474110000
Please send M-Print PRO file		

Type	Qty.	Order No.
CC-M 27/18 2X3 ST	200	1463880000
CC-M 27/18 2X3 AL	200	1463870000
CC-M 27/18 2X3 ST SDR	1	1474140000
CC-M 27/18 2X3 AL SDR	1	1474130000
Please send M-Print PRO file		

Accessories

Primer for pretreatment
Adhesive label
Inlay
Inlay
<b>Note</b>

Type	Qty.	Order No.
PRIMER CC-M	100	2068020000
DKB CC 27/18	320	1341140000
INLAY CC-M 27/18	1	1341040000
INLAY CC-M UNIVERSAL	1	1341120000

Type	Qty.	Order No.
PRIMER CC-M	100	2068020000
INLAY CC-M 27/18	1	1341040000
INLAY CC-M UNIVERSAL	1	1341120000

Technical drawing / application

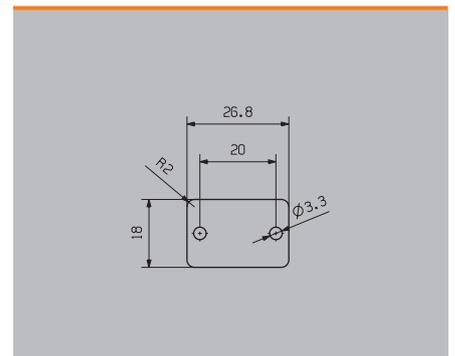
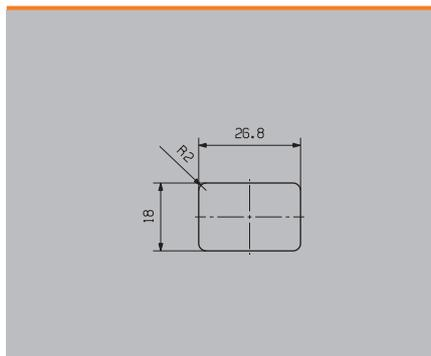

**MetalliCard - individual processing**

**MetalliCard**

**CC-M 85/27**

**85 mm**

**CC-M 85/27 2X3**

**85 mm**



**Technical data**

Ambient temperature (operational)
Width
Height
Drill-hole diameter
Diameter
Labelling field
<b>Note</b>

-55 °C...130 °C
85 mm
27 mm
83.8 x 25.3 mm

-55 °C...130 °C
85 mm
27 mm
3.30 mm
83.8 x 25.3 mm

**Ordering data**

<b>MetalliCard Blank</b>
Micro-etched stainless steel 1.4301 (ST)
Chrome coated aluminium (AL)
<b>MetalliCard custom printing</b>
Micro-etched stainless steel 1.4301 (ST)
Chrome coated aluminium (AL)
<b>Note</b>

Type	Qty.	Order No.
CC-M 85/27 ST	80	1327670000
CC-M 85/27 AL	80	1327650000
CC-M 85/27 ST SDR	1	1474160000
CC-M 85/27 AL SDR	1	1474150000

Please send M-Print PRO file

Type	Qty.	Order No.
CC-M 85/27 2X3 ST	80	1327840000
CC-M 85/27 2X3 AL	80	1327830000
CC-M 85/27 2X3 ST SDR	1	1474180000
CC-M 85/27 2X3 AL SDR	1	1474170000

Please send M-Print PRO file

**Accessories**

Primer for pretreatment
Adhesive label
Inlay
Inlay
<b>Note</b>

Type	Qty.	Order No.
PRIMER CC-M	100	2068020000
DKB CC 85/27	100	1226620000
INLAY CC-M 85/27	1	1341050000
INLAY CC-M UNIVERSAL	1	1341120000

Type	Qty.	Order No.
PRIMER CC-M	100	2068020000
INLAY CC-M 85/27	1	1341050000
INLAY CC-M UNIVERSAL	1	1341120000

**Technical drawing / application**

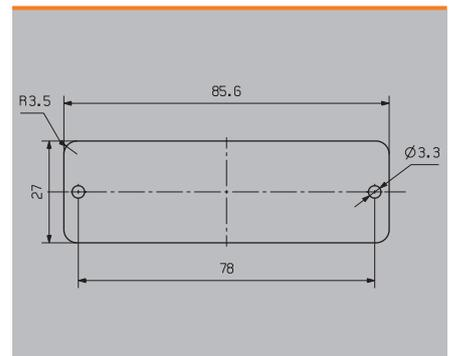
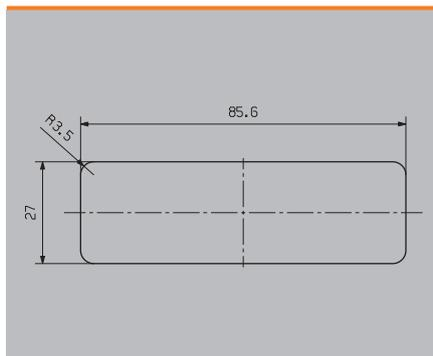

MetalliCard

CC-M 10/30 2X2.5

30 mm

CC-M 58/35

34.8 mm



Technical data

Ambient temperature (operational)
Width
Height
Drill-hole diameter
Diameter
Labelling field
<b>Note</b>

-55 °C...130 °C
30 mm
10 mm
2.50 mm
10.2 x 22.5 mm

-55 °C...130 °C
34.8 mm
58 mm
56 x 33 mm

Ordering data

MetalliCard Blank
Micro-etched stainless steel 1.4301 (ST)
Chrome coated aluminium (AL)
MetalliCard custom printing
Micro-etched stainless steel 1.4301 (ST)
Chrome coated aluminium (AL)
<b>Note</b>

Type	Qty.	Order No.
CC-M 10/30 2X2.5 ST	200	1500150000
CC-M 10/30 2X2.5 AL	200	1483780000
CC-M 10/30 2X2.5 ST SDR	1	1505150000
CC-M 10/30 2X2.5 AL SDR	1	1505140000
Please send M-Print PRO file		

Type	Qty.	Order No.
CC-M 58/35 ST	100	1415730000
CC-M 58/35 AL	100	1415750000
CC-M 58/35 ST SDR	1	1474340000
CC-M 58/35 AL SDR	1	1474330000
Please send M-Print PRO file		

Accessories

Primer for pretreatment
Adhesive label
Inlay
Inlay
<b>Note</b>

Type	Qty.	Order No.
PRIMER CC-M	100	2068020000
INLAY CC-M 10/30	1	1483770000

Type	Qty.	Order No.
PRIMER CC-M	100	2068020000
INLAY CC-M 58/35	1	1415950000

Technical drawing / application

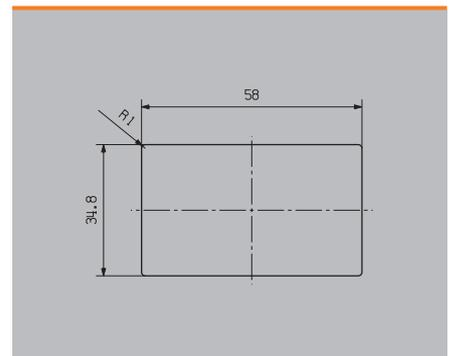
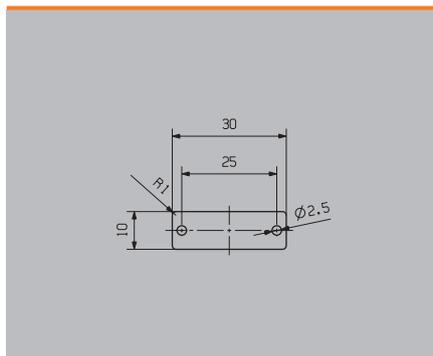

**MetalliCard - individual processing**

**MetalliCard**

**CC-M 58/35 2X3**

**34.8 mm**

**CC-M 15/45**

**45 mm**



**Technical data**

Ambient temperature (operational)
Width
Height
Drill-hole diameter
Diameter
Labelling field
<b>Note</b>

-55 °C...130 °C
34.8 mm
58 mm
3.40 mm
56 x 33 mm

-55 °C...130 °C
45 mm
15 mm
15.2 x 42.2 mm

**Ordering data**

<b>MetalliCard Blank</b>
Micro-etched stainless steel 1.4301 (ST)
Chrome coated aluminium (AL)
<b>MetalliCard custom printing</b>
Micro-etched stainless steel 1.4301 (ST)
Chrome coated aluminium (AL)
<b>Note</b>

Type	Qty.	Order No.
CC-M 58/35 2X3 ST	100	1415670000
CC-M 58/35 2X3 AL	100	1415710000
CC-M 58/35 2X3 ST SDR	1	1474360000
CC-M 58/35 2X3 AL SDR	1	1474350000
Please send M-Print PRO file		

Type	Qty.	Order No.
CC-M 15/45 ST	200	1327740000
CC-M 15/45 AL	200	1327730000
CC-M 15/45 ST SDR	1	1474290000
CC-M 15/45 AL SDR	1	1474280000
Please send M-Print PRO file		

**Accessories**

Primer for pretreatment
Adhesive label
Inlay
Inlay
<b>Note</b>

Type	Qty.	Order No.
PRIMER CC-M	100	2068020000
INLAY CC-M 58/35	1	1415950000

Type	Qty.	Order No.
PRIMER CC-M	100	2068020000
DKB CC 15/45	240	1341170000
INLAY CC-M 15/45	1	1341090000
INLAY CC-M UNIVERSAL	1	1341120000

**Technical drawing / application**

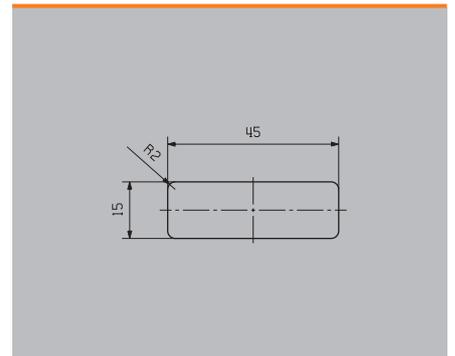
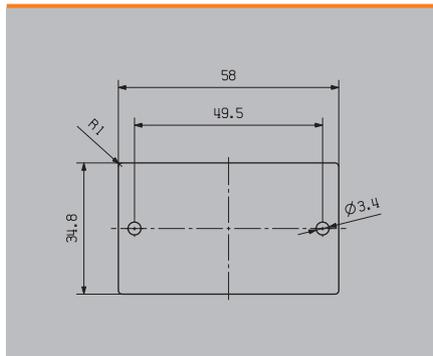

MetalliCard

CC-M 15/45 2X3

45 mm

CC-M 70/48

48 mm



Technical data

Ambient temperature (operational)
Width
Height
Drill-hole diameter
Diameter
Labelling field
<b>Note</b>

-55 °C...130 °C
45 mm
15 mm
3.30 mm
15.2 x 42.2 mm

-55 °C...130 °C
48 mm
70 mm
68 x 46 mm

Ordering data

<b>MetalliCard Blank</b>
Micro-etched stainless steel 1.4301 (ST)
Chrome coated aluminium (AL)
<b>MetalliCard custom printing</b>
Micro-etched stainless steel 1.4301 (ST)
Chrome coated aluminium (AL)
<b>Note</b>

Type	Qty.	Order No.
CC-M 15/45 2X3 ST	200	1327920000
CC-M 15/45 2X3 AL	200	1327900000
CC-M 15/45 2X3 ST SDR	1	1474320000
CC-M 15/45 2X3 AL SDR	1	1474310000

Please send M-Print PRO file

Type	Qty.	Order No.
CC-M 70/48 ST	40	1415740000
CC-M 70/48 AL	40	1415770000
CC-M 70/48 ST SDR	1	1474380000
CC-M 70/48 AL SDR	1	1474370000

Please send M-Print PRO file

Accessories

Primer for pretreatment
Adhesive label
Inlay
Inlay
<b>Note</b>

Type	Qty.	Order No.
PRIMER CC-M	100	2068020000
INLAY CC-M 15/45	1	1341090000
INLAY CC-M UNIVERSAL	1	1341120000

Type	Qty.	Order No.
PRIMER CC-M	100	2068020000
INLAY CC-M 70/48	1	1415940000

Technical drawing / application

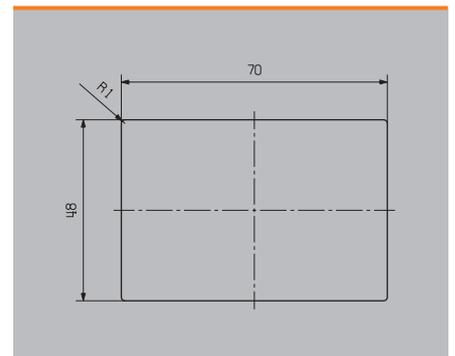
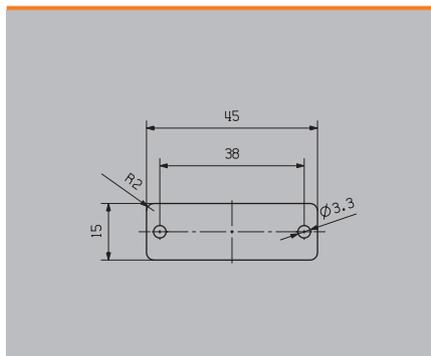

**MetalliCard - individual processing**

**MetalliCard**

**CC-M 70/48 2X3**

**48 mm**

**CC-M 18/52 2X3**

**52 mm**



**Technical data**

Ambient temperature (operational)
Width
Height
Drill-hole diameter
Diameter
Labelling field
<b>Note</b>

-55 °C...130 °C
48 mm
70 mm
3.30 mm
68 x 46 mm

-55 °C...130 °C
52 mm
18 mm
3.30 mm
16 x 50 mm

**Ordering data**

<b>MetalliCard Blank</b>
Micro-etched stainless steel 1.4301 (ST)
Chrome coated aluminium (AL)
<b>MetalliCard custom printing</b>
Micro-etched stainless steel 1.4301 (ST)
Chrome coated aluminium (AL)
<b>Note</b>

Type	Qty.	Order No.
CC-M 70/48 2X3 ST	40	1415680000
CC-M 70/48 2X3 AL	40	1415720000
CC-M 70/48 2X3 ST SDR	1	1474400000
CC-M 70/48 2X3 AL SDR	1	1474390000

Please send M-Print PRO file

Type	Qty.	Order No.
CC-M 18/52 2X3 ST	200	1505350000
CC-M 18/52 2X3 AL	200	1390400000
CC-M 18/52 2X3 ST SDR	1	1505370000
CC-M 18/52 2X3 AL SDR	1	1505360000

Please send M-Print PRO file

**Accessories**

Primer for pretreatment
Adhesive label
Inlay
Inlay
<b>Note</b>

Type	Qty.	Order No.
PRIMER CC-M	100	2068020000
INLAY CC-M 70/48	1	1415940000

Type	Qty.	Order No.
PRIMER CC-M	100	2068020000
INLAY CC-M 18/52	1	1390430000

**Technical drawing / application**

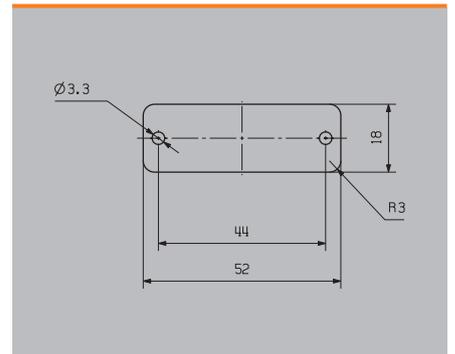
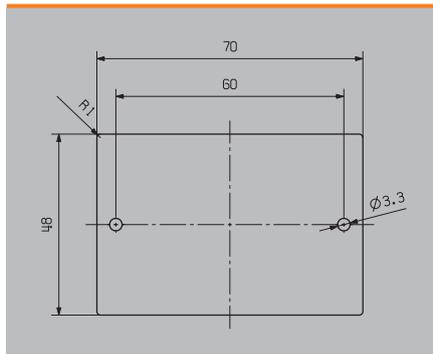



MetalliCard

CC-M 85/54

85 mm

CC-M 85/54 4X3

85 mm



Technical data

Ambient temperature (operational)
Width
Height
Drill-hole diameter
Diameter
Labelling field
<b>Note</b>

-55 °C...130 °C
85 mm
54 mm
83.8 x 52.4 mm

-55 °C...130 °C
85 mm
54 mm
3.30 mm
83.8 x 52.4 mm

Ordering data

MetalliCard Blank
Micro-etched stainless steel 1.4301 (ST)
Chrome coated aluminium (AL)
MetalliCard custom printing
Micro-etched stainless steel 1.4301 (ST)
Chrome coated aluminium (AL)
<b>Note</b>

Type	Qty.	Order No.
CC-M 85/54 ST	40	1327620000
CC-M 85/54 AL	40	1327600000
CC-M 85/54 ST SDR	1	1474060000
CC-M 85/54 AL SDR	1	1474070000
Please send M-Print PRO file		

Type	Qty.	Order No.
CC-M 85/54 4X3 ST	40	1327820000
CC-M 85/54 4X3 AL	40	1327800000
CC-M 85/54 4X3 ST SDR	1	1474090000
CC-M 85/54 4X3 AL SDR	1	1474080000
Please send M-Print PRO file		

Accessories

Primer for pretreatment
Adhesive label
Inlay
Inlay
<b>Note</b>

Type	Qty.	Order No.
PRIMER CC-M	100	2068020000
DKB CC 85/54	100	1175850000
INLAY CC-M 85/54	1	1341030000
INLAY CC-M UNIVERSAL	1	1341120000

Type	Qty.	Order No.
PRIMER CC-M	100	2068020000
INLAY CC-M 85/54	1	1341030000
INLAY CC-M UNIVERSAL	1	1341120000

Technical drawing / application

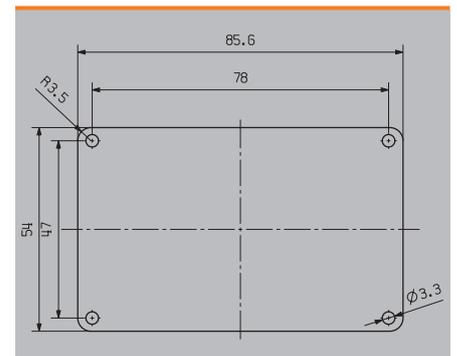
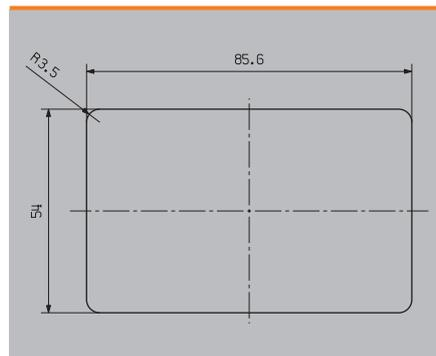

**MetalliCard - individual processing**

**MetalliCard**

**CC-M 15/60**

**60 mm**

**CC-M 15/60 2X3**

**60 mm**



**Technical data**

Ambient temperature (operational)
Width
Height
Drill-hole diameter
Diameter
Labelling field
<b>Note</b>

-55 °C...130 °C
60 mm
15 mm
15.2 x 57.2 mm

-55 °C...130 °C
60 mm
15 mm
3.30 mm
15.2 x 57.2 mm

**Ordering data**

<b>MetalliCard Blank</b>
Micro-etched stainless steel 1.4301 (ST)
Chrome coated aluminium (AL)
<b>MetalliCard custom printing</b>
Micro-etched stainless steel 1.4301 (ST)
Chrome coated aluminium (AL)
<b>Note</b>

Type	Qty.	Order No.
CC-M 15/60 ST	200	1327720000
CC-M 15/60 AL	200	1327700000
CC-M 15/60 ST SDR	1	1474250000
CC-M 15/60 AL SDR	1	1474240000
Please send M-Print PRO file		

Type	Qty.	Order No.
CC-M 15/60 2X3 ST	200	1327890000
CC-M 15/60 2X3 AL	200	1327880000
CC-M 15/60 2X3 ST SDR	1	1474270000
CC-M 15/60 2X3 AL SDR	1	1474260000
Please send M-Print PRO file		

**Accessories**

Primer for pretreatment
Adhesive label
Inlay
Inlay
<b>Note</b>

Type	Qty.	Order No.
PRIMER CC-M	100	2068020000
DKB CC 15/60	160	1341150000
INLAY CC-M 15/60	1	1341080000
INLAY CC-M UNIVERSAL	1	1341120000

Type	Qty.	Order No.
PRIMER CC-M	100	2068020000
INLAY CC-M 15/60	1	1341080000
INLAY CC-M UNIVERSAL	1	1341120000

**Technical drawing / application**

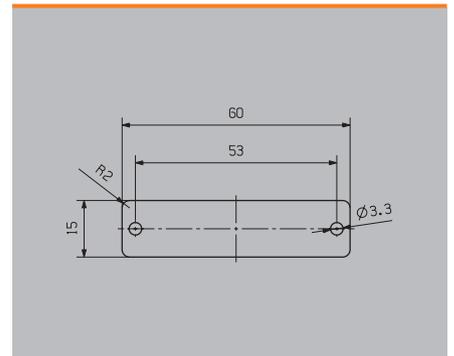
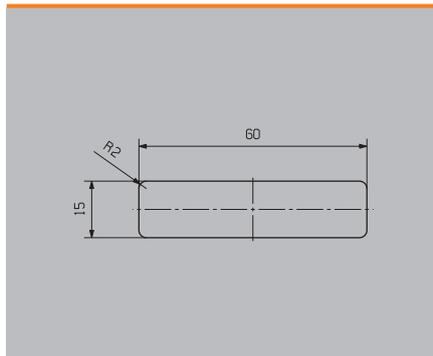

MetalliCard

CC-M 30/60

60 mm

CC-M 30/60 2X3

60 mm



Technical data

Ambient temperature (operational)
Width
Height
Drill-hole diameter
Diameter
Labelling field
<b>Note</b>

-55 °C...130 °C
60 mm
30 mm
30.2 x 57.2 mm

-55 °C...130 °C
60 mm
30 mm
3.30 mm
30.2 x 57.2 mm

Ordering data

<b>MetalliCard Blank</b>
Micro-etched stainless steel 1.4301 (ST)
Chrome coated aluminium (AL)
<b>MetalliCard custom printing</b>
Micro-etched stainless steel 1.4301 (ST)
Chrome coated aluminium (AL)
<b>Note</b>

Type	Qty.	Order No.
CC-M 30/60 ST	100	1327690000
CC-M 30/60 AL	100	1327680000
CC-M 30/60 ST SDR	1	1474210000
CC-M 30/60 AL SDR	1	1474190000
Please send M-Print PRO file		

Type	Qty.	Order No.
CC-M 30/60 2X3 ST	100	1327870000
CC-M 30/60 2X3 AL	100	1327850000
CC-M 30/60 2X3 ST SDR	1	1474230000
CC-M 30/60 2X3 AL SDR	1	1474220000
Please send M-Print PRO file		

Accessories

Primer for pretreatment
Adhesive label
Inlay
Inlay
<b>Note</b>

Type	Qty.	Order No.
PRIMER CC-M	100	2068020000
DKB CC 30/60	100	1341130000
INLAY CC-M 30/60	1	1341070000
INLAY CC-M UNIVERSAL	1	1341120000

Type	Qty.	Order No.
PRIMER CC-M	100	2068020000
INLAY CC-M 30/60	1	1341070000
INLAY CC-M UNIVERSAL	1	1341120000

Technical drawing / application

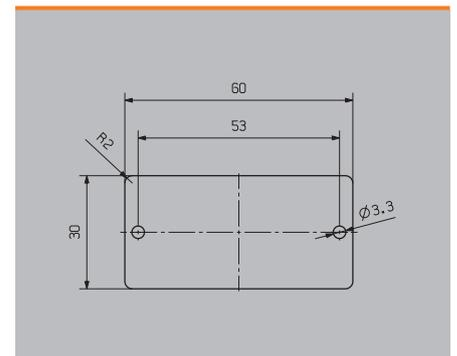
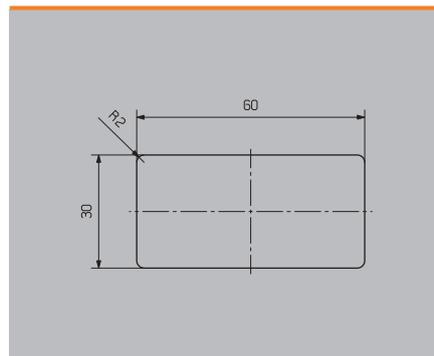

**MetalliCard - individual processing**

**MetalliCard**

**CC-M 27/70 2X3**

**70 mm**

**CC-M 43/70**

**70 mm**



**Technical data**

Ambient temperature (operational)
Width
Height
Drill-hole diameter
Diameter
Labelling field
<b>Note</b>

-55 °C...130 °C
70 mm
27 mm
3.00 mm
68.3 x 25.3 mm

-55 °C...130 °C
70 mm
43 mm
41.3 x 68.3 mm

**Ordering data**

<b>MetalliCard Blank</b>
Micro-etched stainless steel 1.4301 (ST)
Chrome coated aluminium (AL)
<b>MetalliCard custom printing</b>
Micro-etched stainless steel 1.4301 (ST)
Chrome coated aluminium (AL)
<b>Note</b>

Type	Qty.	Order No.
CC-M 27/70 2X3 ST	80	1500190000
CC-M 27/70 2X3 AL	80	1500170000
CC-M 27/70 2X3 ST SDR	1	1505170000
CC-M 27/70 2X3 AL SDR	1	1505160000
Please send M-Print PRO file		

Type	Qty.	Order No.
CC-M 43/70 ST	80	1500220000
CC-M 43/70 AL	80	1500200000
CC-M 43/70 ST SDR	1	1505190000
CC-M 43/70 AL SDR	1	1505180000
Please send M-Print PRO file		

**Accessories**

Primer for pretreatment
Adhesive label
Inlay
Inlay
<b>Note</b>

Type	Qty.	Order No.
PRIMER CC-M	100	2068020000
INLAY CC-M 27/70	1	1500290000

Type	Qty.	Order No.
PRIMER CC-M	100	2068020000
DKB CC 43/70	100	1500340000
INLAY CC-M 43/70	1	1500300000

**Technical drawing / application**

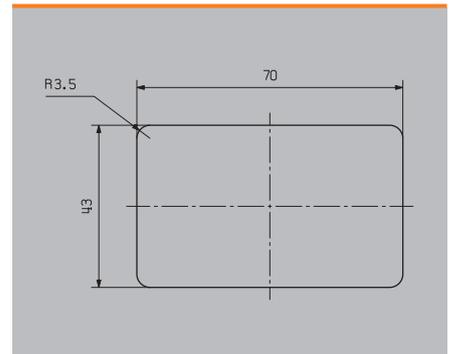
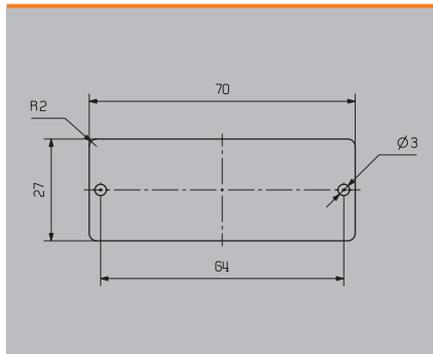

MetalliCard

CC-M DIA 30

30 mm



Technical data

Ambient temperature (operational)	-55 °C...130 °C
Width	
Height	
Drill-hole diameter	4.20 mm
Diameter	30 mm
Labelling field	28.2 x 28.2 mm
Note	

Ordering data

MetalliCard Blank		Type	Qty.	Order No.
	Micro-etched stainless steel 1.4301 (ST)	CC-M DIA 30 ST	200	1327770000
	Chrome coated aluminium (AL)	CC-M DIA 30 AL	200	1327750000
MetalliCard custom printing				
	Micro-etched stainless steel 1.4301 (ST)	CC-M DIA 30 ST SDR	1	1474420000
	Chrome coated aluminium (AL)	CC-M DIA 30 AL SDR	1	1474410000
Note	Please send M-Print PRO file			

Accessories

Type	Qty.	Order No.
Primer for pretreatment	100	2068020000
Adhesive label	200	1341180000
Inlay	1	1341100000
Inlay	1	1341120000
Note		

Technical drawing / application

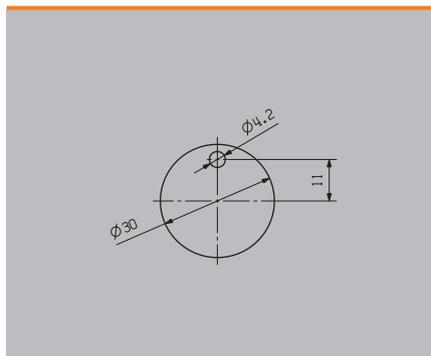



# Thermal transfer & MultiMark

<b>Thermal transfer &amp; MultiMark</b>	Introduction	D.2
	THM MultiMark - the compact all-rounder	D.4
	THM MultiMark PLUS - robust design for larger print jobs	D.6
	MultiMark in use	D.8
	Terminal block markers - Dekafix, WS and MultiFit	D.10
	Wire and cable markers - TM-I, WM, SFM, SFX, ELS and THM ET	D.14
	Wire and cable markers - THM WriteOn	D.20
	Wire and cable markers - shrink sleeves	D.24
	Device markers - ESG, SM, CC and EL	D.34
	Device markers - THM and LM	D.40

## Marking solutions for the whole panel

### MultiMark is the smart all-in-one system

With MultiMark you have a fast and reliable marking system at your disposal to enable virtually any kind of marking. Terminals, conductors, cables or devices – the MultiMark product family offers a well-structured, practical range of markers which can be used in combination with our advanced M-Print® PRO configuration software for all areas of use.

Cost-effectiveness, in particular for small and medium print volumes, results from the integration of the THM MultiMark rapid thermal transfer printer – without compromising the quality. Markings are very legible and resistant to external influences. The THM MultiMark PLUS printer is the ideal partner for medium to large print volumes.



#### THM MultiMark

The THM MultiMark is a robust and modular thermal transfer printer which is particularly beneficial when processing continuous materials. The optional cutting and perforating function allows the continuous material to be divided into any length.

#### THM MultiMark PLUS

The THM MultiMark PLUS is designed for medium to high print volumes. Its robust design makes the printer particularly suitable for industrial environments.







## Printer

## Type of marker

## THM MultiMark

## THM MultiMark PLUS

	THM MultiMark	THM MultiMark PLUS
<b>Technical data</b>		
Technology	Thermal transfer	Thermal transfer
Voltage	AC 230 / AC 115 V	AC 230 / AC 115 V
Resolution	300 dpi	300 dpi
Interfaces	USB 2.0, LAN	USB 2.0, LAN, W-LAN Stick
Network card	●	●
Order No.	2599430000	2599440000
<b>Terminal markers</b>		
DEK MM	●	●
WS MM	●	●
MF MM	●	●
ELS MM	●	●
<b>Cable and wire markers</b>		
SFM	●	●
TM-H MM	●	●
WM MM	●	●
SFX MM	●	●
THM WO	●	●
<b>Device markers</b>		
ESG MM	●	●
SM MM	●	●
CC MM	●	●
EL MM	●	●
ELS MM	●	●
THM MT	●	●
THM MT FS	●	●
THM GEW	●	●
THM EL	●	●
THM ET S7	●	●
THM PA	●	●
THM PA ESO	●	●
<b>Shrink sleeves</b>		
HS and HS-HF	●	●
HSS EL and HSS-HF EL	●	●
HS-FR	●	●

# Thermal transfer printer THM MultiMark

## The compact all-rounder



THM MultiMark

### The only printer you will need for your marking tasks

The THM MultiMark is a compact and modularly constructed thermal transfer printer that makes full use of its many advantages and high number of potential uses. The integrated cutting and perforation option enables continuous materials to be cut to any length – making your work considerably easier when it comes to cutting and assigning the respective labels. The printer edits markers and labels from the MultiMark family as well as continuous materials, textile and polyester labels, heat shrink sleeves and PLC labels.

Snap-on terminal markers are printed using a separate print contact pressure roller, which can be changed in just 30 seconds.

Another plus: the device is very easy to operate thanks to an intuitive touch display and clear status indicators – in 22 languages. The compact design and low weight of 3.5 kg also ensures that the THM MultiMark really can be used anywhere, e.g. as a mobile printer for your on-site jobs.



All-rounder THM MultiMark: the printer handles marking jobs that would otherwise need to be done by several different devices.

### Technical data

	Description
Intended use	Printing Weidmüller MultiMark, DEK, WS and MF strip marker, shrink tubes, label on rolls
Technology	Thermal transfer
Feed	Manuall mounting
Application site	Office conditions
Ambient temperature	5 °C to 40 °C
Included in delivery	<ul style="list-style-type: none"> <li>• THM MultiMark</li> <li>• Power cable (Typ E+F/ UK/ USA)</li> <li>• Ink ribbon RIBBON MM-TB 25/360 SW</li> <li>• Ink ribbon RIBBON MM 110/360 SW</li> <li>• Cardboard core</li> <li>• Pressure roller THM MMP ROLLER TB</li> <li>• Pressure roller THM MMP ROLLER 115</li> <li>• USB cable</li> <li>• Operating manual</li> <li>• DVD with M-Print® PRO software</li> </ul>

### Your benefits with THM MultiMark

- A printer for all jobs
- Ideal for small and medium print volumes
- Virtually maintenance-free thanks to thermal transfer technology
- Excellent readability (resolution: 300 dpi)
- Flexibility provided by modular perforation and cutting unit
- The contact pressure roller can be changed in 30 seconds
- High output, from 250 Dekafix markers/min.

Thermal transfer printer

THM MultiMark

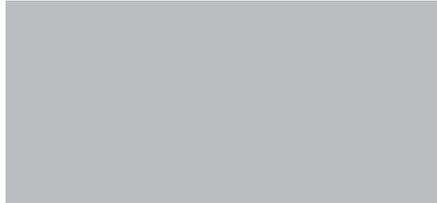

Technical data

EAN	4050118626377
Depth	253 mm
Width	253 mm
Height	320 mm
Net weight	5800 GRM
Printing method	Thermotransfer
Printing speed	max. 150 mm/s
Marker type	MultiMark, Shrink-fit sleeves, Label reel
Interface	USB 2.0, Ethernet
Voltage supply	100...240 V AC
Software	M-Print® PRO
<b>Note</b>	

Ordering data

Type	Qty.	Order No.
THM MULTIMARK	1	2599430000
<b>Note</b>		

Accessories

Cutting blade		Type	Qty.	Order No.
		THM MMP CUTTER	1	1331600000
		THM MMP PERFORATOR	1	1416330000
Printer ribbons		RIBBON MM-TB 25/360 SW	1	2005090000
	Terminal block markers	RIBBON MM 110/360 SW	1	2005070000
	Label, wide, black	RIBBON MM 76/360 SW	1	2005080000
	Label, narrow, black	RIBBON MM 84/300 WS	1	2005040000
	Label, narrow, white	RIBBON HSS HF EL 40/300	1	1426210000
	Shrink sleeve, endless	RIBBON MM-HS 60/300 SW	1	2448880000
	Shrink sleeve, assembled			
Printer roller		THM MMP ROLLER TB	1	2438500000
	Weidmüller DEK, WS	THM MMP ROLLER MF	1	2518600000
	MultiFit Phoenix	THM MMP ROLLER MF-W	1	2519150000
	MultiFit Wago	THM MMP ROLLER 115	1	1357420000
	Labels, shrink sleeves	THM MMP ROLLER SFM 3	1	2719270000
	Weidmüller SFM3			
Miscellaneous accessories		THM MMP EXT.RH	1	1302920000
	Reel holder	THM MMP CASE	1	2457760000
	Case			
<b>Note</b>				

# THM MultiMark Plus thermal transfer printer

## Robust design for larger print jobs



THM MultiMark PLUS

### The perfect partner at your side

The THM MultiMark PLUS thermal transfer printer impresses with its robust design which is perfectly suited for harsher environments. With its high speed, the printer is ideal for medium and large print volumes. In addition, the THM MultiMark PLUS is equipped with a WLAN stick which makes working with the printer even more flexible.

The printer effortlessly prints the entire MultiMark range and can also be extended to include a perforation option. Operation is made even simpler thanks to the intuitive display with 22 integrated languages and the status displays.



Output of all continuous materials, woven fabric and polyester labels, shrink sleeves and PLC labels at high speed and high resolution.

### Technical data

	Description
Intended use	Printing Weidmüller MultiMark, DEK, WS and MF strip marker, shrink tubes, label on rolls
Technology	Thermal transfer
Feed	Manuall mounting
Application site	Electrical workshop
Ambient temperature	5 °C to 40 °C
Included in delivery	<ul style="list-style-type: none"> <li>• THM MultiMark Plus</li> <li>• Power cable (Typ E+F/ UK/ USA)</li> <li>• Ink ribbon RIBBON MM-TB 25/360 SW</li> <li>• Ink ribbon RIBBON MM 110/360 SW</li> <li>• Cardboard core</li> <li>• Pressure roller THM MMP ROLLER TB</li> <li>• Pressure roller THM MMP ROLLER 115</li> <li>• USB cable</li> <li>• Operating manual</li> <li>• DVD with M-Print® PRO software</li> <li>• WLAN stick</li> <li>• Additional tear-off edge for strip markers</li> </ul>

### Your benefits with THM MultiMark PLUS

- A printer for all jobs
- Long service life even with high capacity utilisation thanks to robust design
- Ideal for medium and large print volumes
- Virtually maintenance-free (minimum maintenance effort) thanks to thermal transfer technology
- Excellent readability (resolution: 300 dpi)
- Flexibility provided by modular perforation and cutting unit
- The contact pressure roller can be changed in 30 seconds
- High output, from 250 Dekafix markers/min.
- Ready for WLAN use

Thermal transfer printer

THM MultiMark Plus



Technical data

EAN	4050118626360
Depth	274 mm
Width	242 mm
Height	446 mm
Net weight	10000 GRM
Printing method	Thermotransfer
Printing speed	max. 300 mm/s
Print quality	300 DPI
Marker type	MultiMark, Shrink-fit sleeves, Label reel
Interface	USB 2.0, Ethernet, Wi-Fi
Voltage supply	100...240 V AC
Software	M-Print® PRO
<b>Note</b>	

Ordering data

Type	Qty.	Order No.
THM MULTIMARK PLUS	1	2599440000
<b>Note</b>		

Accessories

Perforator		Type	Qty.	Order No.
		THM PLUS M PERFORATOR	1	1540770000
Printer ribbons				
Terminal block markers		RIBBON MM-TB 25/360 SW	1	2005090000
Label, wide, black		RIBBON MM 110/360 SW	1	2005070000
Label, narrow, black		RIBBON MM 76/360 SW	1	2005080000
Label, narrow, white		RIBBON MM 84/300 WS	1	2005040000
Shrink sleeve, endless		RIBBON HSS HF EL 40/300	1	1426210000
Shrink sleeve, assembled		RIBBON MM-HS 60/300 SW	1	2448880000
Printer roller				
Weidmüller DEK, WS		MM PLUS ROLLER TB	1	2661600000
MultiFit Phoenix		MM PLUS ROLLER MF	1	2661610000
MultiFit Wago		MM PLUS ROLLER MF-W	1	2661620000
Labels, shrink sleeves		THM MMP ROLLER 115	1	1357420000
Weidmüller SFM3		THM MMP ROLLER SFM 3	1	2719270000
<b>Note</b>				

# MultiMark in use

## Professional and user-friendly

### Marking: added value for every system

Standards and guidelines call for correct presentation and identification of installed components and associated documentation. The systematic use of MultiMark will put you on the right track to documenting your system in a meaningful way.

### User-friendly Usage and handling

The outstanding properties of the different marker types make it easy for you to use MultiMark as an all-purpose marking system. Durable material, strong adhesive labels, perforations – each and every detail has been carefully considered and subjected to extensive practical tests.

### Your benefits with MultiMark

- Over 600 marking products on offer
- Practically all identification requirements are taken care of
- Fast printing, fast Identification
- Handling benefits, e.g. for terminal markers
- Excellent material properties
- Convenient handling
- Clear print image



SM/CC: Eye-catching and highly adhesive equipment labels - ensure that devices are used correctly



DEK/WS/MF: Flexible connector markers - print, clip, finished



WM: Wire markers installed without tools - simply edit your projects on a computer then print on a reel





ESG: All-purpose equipment identification - simple labelling of markers for quick identification of components



SFX: Highly flexible cable markers - determine the maximum diameter from the length of the cable tie

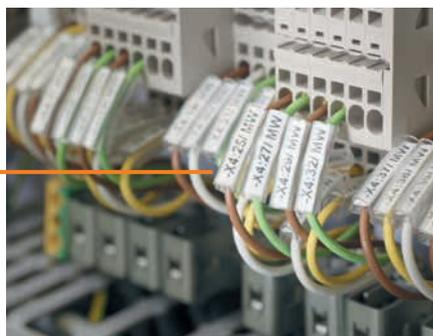

TM-I: Plug-in wire markers - easy to install before and after the sleeve assembly

# Dekafix, WS and MultiFit Terminal block markers

## Make your labelling more efficient

### Snaps securely into place in combination

With a marking system for terminal markers you expect the markers to be printed quickly and just as quickly snapped into place. The markers also need to have a high resistance to shocks and vibration. Our terminal markers meet these requirements in full.

MultiMark terminal markers make use of an innovative composite material of two components. The hard base contour of the marker snaps securely into the connector. The elastic surface finish makes the marker easy and ergonomic to mount.

Another advantage: the excellent printability of the surface material guarantees durable and wear-resistant labelling. A print resolution of 300 dpi also produces a easy to read script.

### The adaptable range of markers

For manufacturer-independent marking of components, we have developed the adaptable MultiFit marker range. Without giving up the highly professional printing with Weidmüller's marking system, you can use your usual components from other manufacturers, and combine them with Weidmüller's MultiFit markers.



THM MultiMark



THM MultiMark PLUS



The smart composite material ensures perfect usage and handling.

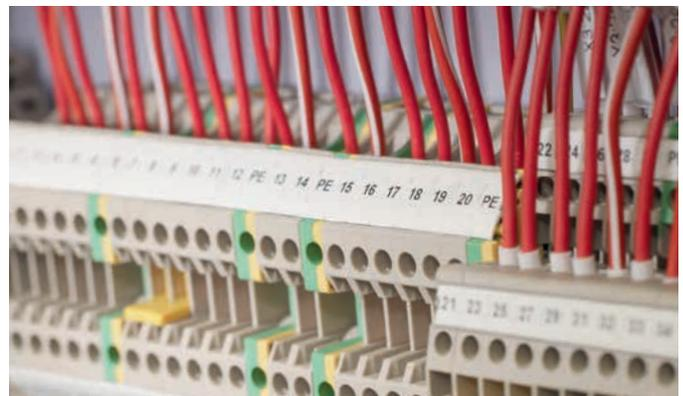

DEK/WS/MF: Expandable terminal block markers – uninterrupted output, snap on, ready.



### Ordering data DEK/WS/MF

Possible printing systems	THM MultiMark, THM MultiMark PLUS
Ink ribbon	RIBBON MM-TB 25/360 SW (2005090000)
Pressure roller THM MultiMark	Weidmüller DEK/WS: THM MMP ROLLER TB (2438500000) MultiFit Phoenix: THM MMP ROLLER MF (2518600000) MultiFit Wago: THM MMP ROLLER MF-W (2519150000)
Pressure roller THM MultiMark PLUS	Weidmüller DEK/WS: MMP PLUS ROLLER TB (2661600000) MultiFit Phoenix: MMP PLUS ROLLER MF (2661610000) MultiFit Wago: MMP PLUS ROLLER MF-W (2661620000)

### Your benefits with MultiMark

- Manufacturer-independent terminal marking
- Firm hold and durable printing
- Continuous strip marker saves installation time
- Easy mounting thanks to an innovative composite material
- Large text field enables best readability



## DEK terminal markers

## Technical data

Material	Temperature range	Fire class acc. to UL 94	Adhesive	Order No.	Type
PC-ABS, TPU	-50...90 °C	V-2		2005090000	RIBBON MM-TB 25/360 SW

## Ordering data

Order No.	Type	Colour	Height	Width	Qty.
2007100000	DEK 5/3.5 MM WS	white	5 mm	3.5 mm	1000
2619760000	DEK 5/3.5 MM BP WS	white	5 mm	3.5 mm	15000
2007110000	DEK 5/5 MM WS	white	5 mm	5 mm	800
2619770000	DEK 5/5 MM BP WS	white	5 mm	5 mm	10000
2007120000	DEK 5/6 MM WS	white	5 mm	6 mm	600
2619780000	DEK 5/6 MM BP WS	white	5 mm	6 mm	9000
2619920000	DEK 5/7.5 MM WS	white	5 mm	7.5 mm	500
2007130000	DEK 5/8 MM WS	white	5 mm	8 mm	500
2619790000	DEK 5/8 MM BP WS	white	5 mm	8 mm	6000
2448860000	DEK-A 5/8 MM WS	white	5 mm	8.1 mm	500

Note: External roll holder required for BP

## WS terminal markers

## Technical data

Material	Temperature range	Fire class acc. to UL 94	Adhesive	Order No.	Type
PC-ABS, TPU	-50...90 °C	V-2		2005090000	RIBBON MM-TB 25/360 SW

## Ordering data

Order No.	Type	Colour	Height	Width	Qty.
2007140000	WS 8/3.5 MM WS	white	8 mm	3.5 mm	1000
2619800000	WS 8/3.5 MM BP WS	white	8 mm	3.5 mm	11000
2007150000	WS 8/5 MM WS	white	8 mm	5 mm	800
2619810000	WS 8/5 MM BP WS	white	8 mm	5 mm	8000
2712130000	WS 10/5 MM WS	white	10 mm	5 mm	800
2007160000	WS 8/6 MM WS	white	8 mm	6 mm	600
2619820000	WS 8/6 MM BP WS	white	8 mm	6 mm	6000
2712140000	WS 10/6 MM WS	white	10 mm	6 mm	600
2007170000	WS 8/8 MM WS	white	8 mm	8 mm	500
2619830000	WS 8/8 MM BP WS	white	8 mm	8 mm	5000
2619890000	WS-A 8/10 MM WS	white	8 mm	10 mm	350
2619900000	WS-A 8/12 MM WS	white	8 mm	12 mm	300
2619910000	WS-A 8/16 MM WS	white	8 mm	16 mm	200
2448930000	WS-A 8/8 MM WS	white	8 mm	8.1 mm	500
2007180000	WS 12/3.5 MM WS	white	12 mm	3.5 mm	1000
2619840000	WS 12/3.5 MM BP WS	white	12 mm	3.5 mm	8000
2007190000	WS 12/5 MM WS	white	12 mm	5 mm	800
2619850000	WS 12/5 MM BP WS	white	12 mm	5 mm	5500
2007200000	WS 12/6 MM WS	white	12 mm	6 mm	600
2619860000	WS 12/6 MM BP WS	white	12 mm	6 mm	4500
2619930000	WS 12/6.5 MM WS	white	12 mm	6.5 mm	600
2007210000	WS 12/8 MM WS	white	12 mm	8 mm	500
2619870000	WS 12/8 MM BP WS	white	12 mm	8 mm	3500
2448920000	WS-A 12/8 MM WS	white	12 mm	8.1 mm	500

Note: External roll holder required for BP



## MultiFit terminal markers

## Technical data

Material	Temperature range	Fire class acc. to UL 94	Adhesive	Order No.	Type
PC-ABS, TPU	-50...90 °C	V-2		2005090000	RIBBON MM-TB 25/360 SW

## Ordering data

Order No.	Type		Colour	Height	Width	Qty.
2519170000	MF 10/5 MM WS	○	white	10 mm	5 mm	600
2712150000	MF 10/5 MM BP WS	○	white	10 mm	5 mm	4500
2519180000	MF 10/6 MM WS	○	white	10 mm	6 mm	500
2712160000	MF 10/6 MM BP WS	○	white	10 mm	6 mm	3800
2519190000	MF 10/8 MM WS	○	white	10 mm	8 mm	400
2712170000	MF 10/8 MM BP WS	○	white	10 mm	8 mm	2800
2519200000	MF 5/5 MM WS	○	white	5 mm	5 mm	1200
2519210000	MF 5/6 MM WS	○	white	5 mm	6 mm	1000
2518500000	MF 8/5 MM WS	○	white	8 mm	5 mm	600
2519220000	MF-W 5/5 MINI MM WS	○	white	5 mm	5 mm	800
2519230000	MF-W 9/5 MM WS	○	white	9 mm	5 mm	1200
2519250000	MF-W 9/5.2 F MM WS	○	white	9 mm	5.2 mm	800
2519240000	MF-W 9/5 F MM WS	○	white	9 mm	5 mm	800

Note: External roll holder required for BP





# Wire and cable markers TM-I, WM, SFM, SFX, ELS and THM ET

## Make your connections visible

A control cabinet can only pass the acceptance test if the various circuits can be unequivocally identified. Using our markers to uniquely identify wires and cables lets you make the most of your options and profit from a range of additional benefits.

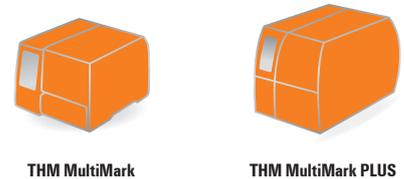

THM MultiMark

THM MultiMark PLUS

### Process reliability: TM-I

TM-I insert tags have a guide tab which enables them to slide easily into the transparent sleeves. Once the label is in place, the tab can be snapped off at the predetermined break point. The ready-assembled sleeves are then simply pushed over the wires. Your benefits: large quantities can be efficiently pre-assembled in a single step. This saves both time and money.



Processing reliability thanks to the precisely placed break point. The TM-I is inserted into the sleeve in no time at all: push in, bend up and down and you're done.

### Un-detachable: WM

Our closed, un-detachable markers are mounted without the need for additional tools. The cable is simply threaded through the openings at both ends before wiring takes place. The inherent tension of the material fixes the marker in place. WM markers are available in four sizes for wire cross-sections from 0.25 mm<sup>2</sup> to 16 mm<sup>2</sup>. For each size you can choose from three label lengths and two colours. This provides you with just the right assortment for carrying out the everyday task of labelling conductors in a control cabinet.



WM markers are available in four sizes for wire cross-sections from 0.25 mm<sup>2</sup> to 16 mm<sup>2</sup>.

### Highly flexible: SFX

SFX markers are the preferred choice for identifying cables if you opt for a classic cable tie solution. Cables do not by nature always run in a straight line. The material used in SFX markers addresses this circumstance with highly flexible polyurethane. The marker follows every curve of the cable and latches on without resistance.

Additional cable and conductor markers are the **ELS** insertion labels and the **THM ET** labels, which are attached to the conductor using cable ties.



### Ordering data Gerätemarkierer

Possible printing systems	THM MultiMark, THM MultiMark PLUS
Ink ribbon	2005070000 RIBBON MM 110/360 SW (black) 2005080000 RIBBON MM 76/360 SW (black) 2005040000 RIBBON MM 80/300 WS (white)
Pressure roller	Labels, shrink sleeves: THM MMP ROLLER 115 (1357420000), SFM 3: THM MMP ROLLER SFM3 (2719270000)

### Your benefits with MultiMark

- Compact, practical range of products
- Quickly printed and assembled
- Reliable identification of your connections
- Excellent material properties
- Large label field ensures good legibility

## WM wire markers

## Technical data

Material	Temperature range	Fire class acc. to UL 94	Adhesive	Order No.	Type
Polyester	-40...150 °C	HB		2005080000	RIBBON MM 76/360 SW

## Ordering data

Order No.	Type	Colour	Wire O.D.	Labelling field	Qty.
2006250000	WM 0/12 1.0-2.0 MM GE	● yellow	1 - 2 mm	13 x 3.5 mm	2000
2006170000	WM 0/12 1.0-2.0 MM WS	○ white	1 - 2 mm	13 x 3.5 mm	2000
2006090000	WM 0/21 1.0-2.0 MM GE	● yellow	1 - 2 mm	22 x 3.5 mm	2000
2006010000	WM 0/21 1.0-2.0 MM WS	○ white	1 - 2 mm	22 x 3.5 mm	2000
2006410000	WM 0/6 1.0-2.0 MM GE	● yellow	1 - 2 mm	7 x 3.5 mm	2000
2006330000	WM 0/6 1.0-2.0 MM WS	○ white	1 - 2 mm	7 x 3.5 mm	2000
2006270000	WM 1/12 2.0-3.5 MM GE	● yellow	2 - 3.5 mm	13 x 4.8 mm	2000
2006190000	WM 1/12 2.0-3.5 MM WS	○ white	2 - 3.5 mm	13 x 4.8 mm	2000
2006110000	WM 1/21 2.0-3.5 MM GE	● yellow	2 - 3.5 mm	22 x 4.8 mm	2000
2006030000	WM 1/21 2.0-3.5 MM WS	○ white	2 - 3.5 mm	22 x 4.8 mm	2000
2006430000	WM 1/6 2.0-3.5 MM GE	● yellow	2 - 3.5 mm	7 x 4.8 mm	2000
2006350000	WM 1/6 2.0-3.5 MM WS	○ white	2 - 3.5 mm	7 x 4.8 mm	2000
2006290000	WM 2/12 3.5-5.0 MM GE	● yellow	3.5 - 5 mm	12 x 6.4 mm	2000
2006210000	WM 2/12 3.5-5.0 MM WS	○ white	3.5 - 5 mm	12 x 6.4 mm	2000
2006130000	WM 2/21 3.5-5.0 MM GE	● yellow	3.5 - 5 mm	22 x 6.4 mm	2000
2006050000	WM 2/21 3.5-5.0 MM WS	○ white	3.5 - 5 mm	22 x 6.4 mm	2000
2006450000	WM 2/6 3.5-5.0 MM GE	● yellow	3.5 - 5 mm	7 x 6.4 mm	2000
2006370000	WM 2/6 3.5-5.0 MM WS	○ white	3.5 - 5 mm	7 x 6.4 mm	2000
2006310000	WM 3/12 5.0-8.0 MM GE	● yellow	5 - 8 mm	12 x 10 mm	2000
2006230000	WM 3/12 5.0-8.0 MM WS	○ white	5 - 8 mm	12 x 10 mm	2000
2006150000	WM 3/21 5.0-8.0 MM GE	● yellow	5 - 8 mm	22 x 10 mm	2000
2006070000	WM 3/21 5.0-8.0 MM WS	○ white	5 - 8 mm	22 x 10 mm	2000
2006470000	WM 3/6 5.0-8.0 MM GE	● yellow	5 - 8 mm	7 x 10 mm	2000
2006390000	WM 3/6 5.0-8.0 MM WS	○ white	5 - 8 mm	7 x 10 mm	2000

## SFM wire marker

## Technical data

Material	Temperature range	Fire class acc. to UL 94	Adhesive	Order No.	Type
PC-ABS, TPU	-50...90 °C	V-2		2005090000	RIBBON MM-TB 25/360 SW

## Ordering data

Order No.	Type	Colour	Wire O.D.	Labelling field	Qty.
2719180000	SFM 3/12 2.5-3.3 MM GE	● yellow	2.5 - 3.3 mm	3.7 x 9.5 mm	1400
2719150000	SFM 3/12 2.5-3.3 MM WS	○ white	2.5 - 3.3 mm	3.7 x 9.5 mm	1400
2719190000	SFM 3/18 2.5-3.3 MM GE	● yellow	2.5 - 3.3 mm	3.7 x 15.5 mm	900
2719160000	SFM 3/18 2.5-3.3 MM WS	○ white	2.5 - 3.3 mm	3.7 x 15.5 mm	900
2719200000	SFM 3/24 2.5-3.3 MM GE	● yellow	2.5 - 3.3 mm	3.7 x 21.5 mm	700
2719170000	SFM 3/24 2.5-3.3 MM WS	○ white	2.5 - 3.3 mm	3.7 x 21.5 mm	700



**TM-I wire markers**

**Technical data**

Material	Temperature range	Fire class acc. to UL 94	Adhesive	Order No.	Type
Polyester	-40...150 °C	HB		<b>2005080000</b>	RIBBON MM 76/360 SW

**Ordering data**

Order No.	Type	Colour	Height	Width	Qty.
2005440000	TM-I 12 MM WS	○ white	12 mm	4 mm	2000
2005450000	TM-I 15 MM WS	○ white	15 mm	4 mm	2000
2005470000	TM-I 18 MM WS	○ white	18 mm	4 mm	2000
2005490000	TM-I 20 MM WS	○ white	20 mm	4 mm	2000
2005510000	TM-I 23 MM WS	○ white	23 mm	4 mm	2000
2005530000	TM-I 30 MM WS	○ white	30 mm	4 mm	2000
2005890000	TM-I 12 MM BL	● blue	12 mm	4 mm	2000
2005550000	TM-I 12 MM GE	● yellow	12 mm	4 mm	2000
2005730000	TM-I 12 MM RT	● red	12 mm	4 mm	2000
2005910000	TM-I 15 MM BL	● blue	15 mm	4 mm	2000
2005580000	TM-I 15 MM GE	● yellow	15 mm	4 mm	2000
2005760000	TM-I 15 MM RT	● red	15 mm	4 mm	2000
2005930000	TM-I 18 MM BL	● blue	18 mm	4 mm	2000
2005610000	TM-I 18 MM GE	● yellow	18 mm	4 mm	2000
2005790000	TM-I 18 MM RT	● red	18 mm	4 mm	2000
2005950000	TM-I 20 MM BL	● blue	20 mm	4 mm	2000
2005640000	TM-I 20 MM GE	● yellow	20 mm	4 mm	2000
2005820000	TM-I 20 MM RT	● red	20 mm	4 mm	2000
2005970000	TM-I 23 MM BL	● blue	23 mm	4 mm	2000
2005670000	TM-I 23 MM GE	● yellow	23 mm	4 mm	2000
2005850000	TM-I 23 MM RT	● red	23 mm	4 mm	2000
2005990000	TM-I 30 MM BL	● blue	30 mm	4 mm	2000
2005700000	TM-I 30 MM GE	● yellow	30 mm	4 mm	2000
2005870000	TM-I 30 MM RT	● red	30 mm	4 mm	2000



**ELS inlay tags**

**Technical data**

Material	Temperature range	Fire class acc. to UL 94	Adhesive	Order No.	Type
Polyester	-40...150 °C	HB		<b>2005080000</b>	RIBBON MM 76/360 SW

**Ordering data**

Order No.	Type	Colour	Height	Width	Qty.
2010620000	ELS 6/30 MM GE	● yellow	30 mm	6 mm	3000
2009980000	ELS 6/30 MM WS	○ white	30 mm	6 mm	3000
2005260000	ELS 16/40 MM GE	● yellow	40 mm	16 mm	2000
2005200000	ELS 16/40 MM WS	○ white	40 mm	16 mm	2000
2519160000	ELS 7/40 MM GE	● yellow	40 mm	6.3 mm	3000
2518620000	ELS 7/40 MM WS	○ white	40 mm	6.3 mm	3000
2005240000	ELS 8/20 MM GE	● yellow	20 mm	8 mm	3000
2005180000	ELS 8/20 MM WS	○ white	20 mm	8 mm	3000



## SFX cable markers

## Technical data

Material	Temperature range	Fire class acc. to UL 94	Adhesive	Order No.	Type
Polyurethane	-40...90 °C	HB		<b>2005040000</b>	RIBBON MM 84/300 WS
				<b>2005080000</b>	RIBBON MM 76/360 SW

## Ordering data

Order No.	Type	Colour	Height / Width	Labelling field	Qty.
2519100000	SFX 9/24 MM BL	● blue	26 / 15 mm	23.5 x 9 mm	1000
2005380000	SFX 9/24 MM GE	● yellow	26 / 15 mm	23.5 x 9 mm	1000
2519080000	SFX 9/24 MM GN	● green	26 / 15 mm	23.5 x 9 mm	1000
2519090000	SFX 9/24 MM RT	● red	26 / 15 mm	23.5 x 9 mm	1000
2519070000	SFX 9/24 MM SW	● black	26 / 15 mm	23.5 x 9 mm	1000
2005320000	SFX 9/24 MM WS	○ white	26 / 15 mm	23.5 x 9 mm	1000
2712100000	SFX 9/24 MM BP GE	● yellow	26 / 15 mm	23.5 x 9 mm	9000
2712090000	SFX 9/24 MM BP WS	○ white	26 / 15 mm	23.5 x 9 mm	9000
2519060000	SFX 11/60 MM BL	● blue	60 / 13 mm	44 x 10.5 mm	1000
2005400000	SFX 11/60 MM GE	● yellow	60 / 13 mm	44 x 10.5 mm	1000
2519050000	SFX 11/60 MM GN	● green	60 / 13 mm	44 x 10.5 mm	1000
2519040000	SFX 11/60 MM RT	● red	60 / 13 mm	44 x 10.5 mm	1000
2518650000	SFX 11/60 MM SW	● black	60 / 13 mm	44 x 10.5 mm	1000
2005340000	SFX 11/60 MM WS	○ white	60 / 13 mm	44 x 10.5 mm	1000
2712120000	SFX 11/60 MM BP GE	● yellow	60 / 13 mm	44 x 10.5 mm	6000
2712110000	SFX 11/60 MM BP WS	○ white	60 / 13 mm	44 x 10.5 mm	6000
2519140000	SFX 30/60 MM BL	● blue	60 / 32 mm	45 x 29.5 mm	300
2005420000	SFX 30/60 MM GE	● yellow	60 / 32 mm	45 x 29.5 mm	300
2519110000	SFX 30/60 MM GN	● green	60 / 32 mm	45 x 29.5 mm	300
2519130000	SFX 30/60 MM RT	● red	60 / 32 mm	45 x 29.5 mm	300
2519120000	SFX 30/60 MM SW	● black	60 / 32 mm	45 x 29.5 mm	300
2005360000	SFX 30/60 MM WS	○ white	60 / 32 mm	45 x 29.5 mm	300

Note: External roll holder required for BP.



## SFX-VT cable markers - Transportation industry

## Technical data

Material	Temperature range	Fire class acc. to UL 94	Adhesive	Order No.	Type
Polyolefine	-55...105 °C	HB		<b>2448880000</b>	RIBBON MM-HS 60/300 SW

## Ordering data

Order No.	Type	Colour	Height / Width	Labelling field	Qty.
2621460000	SFX-VT 9/24 MM GE	● yellow	26 / 15 mm	23.5 x 9 mm	1000
2621470000	SFX-VT 9/24 MM WS	○ white	26 / 15 mm	23.5 x 9 mm	1000
2621440000	SFX-VT 11/60 MM GE	● yellow	60 / 13 mm	10.5 x 44 mm	1000
2621450000	SFX-VT 11/60 MM WS	○ white	60 / 13 mm	10.5 x 44 mm	1000

## SFX-DT cable markers - Detectable

## Technical data

Material	Temperature range	Fire class acc. to UL 94	Adhesive	Order No.	Type
Polyethylene	-30...65 °C	HB		<b>2448880000</b>	RIBBON MM-HS 60/300 SW

## Ordering data

Order No.	Type	Colour	Height / Width	Labelling field	Qty.
2621490000	SFX-DT 9/24 MM BL	● blue	26 / 15 mm	23.5 x 9 mm	1000
2621480000	SFX-DT 11/60 MM BL	● blue	60 / 13 mm	10.5 x 44 mm	1000



## Wire and cable markers – TM-I, WM, SFM, SFX, ELS and THM ET

## THM ET cable markers

## Technical data

Material	Temperature range	Fire class acc. to UL 94	Adhesive	Order No.	Type
Polypropylene	-50...100 °C	HB		2448880000	RIBBON MM-HS 60/300 SW

## Ordering data

Order No.	Type		Colour	Height / Width	Diameter	Qty.
2539410000	THM ET 28/28 WS	○	white	28 / 28 mm		1500
2539380000	THM ET 55/55 WS	○	white	55 / 55 mm		1000
2539400000	THM ET DIA 55 WS	○	white		55 mm	1000
2539390000	THM ET TA 58/55 WS	○	white	58 / 55 mm		1000







# WriteOn

## Cable labels



THM MultiMark



THM MultiMark PLUS

### Tough polyester labels with high elasticity

The WriteOn cable labels are used to label wires and cables up to an outside diameter of 36 mm.

The transparent adhesive strip fixes and protects the printing on the marker surface.

The new THM WO-Q and THM WO-QX have a special type of carrier material and therefore make it easier to separate the labels in each case. THM MultiMark PLUS In addition, the THM WO-QX have perforations in the transparent protective film and therefore enable versatile mounting on different conductor diameters.



The marking is protected against dirt and abrasion by the transparent strip



### Technical data THM WO, THM WO-Q, THM WO-QX

THM WriteOn	
Material	Polyester film
UL 94 flammability rating	HB
Approval acc. to UL 96	Yes
Temperature range	-40 °C to 150 °C
Adhesive	Acrylate

### Technical data THM WO T

Material	Polyvinyl fluoride film - Tedlar®
UL 94 flammability rating	HB
Approval acc. to UL 96	No
Temperature range	-40 °C to 140 °C
Adhesive	Acrylate

### Technical data THM WO VIN

Material	Vinyl film
UL 94 flammability rating	HB
Approval acc. to UL 96	No
Temperature range	-40 °C to 80 °C
Adhesive	Acrylate

### Ordering data THM WriteOn

Possible printing systems	THM MultiMark, THM MultiMark PLUS
Ink ribbon	RIBBON MM 110/360 SW (2005070000)
Pressure roller	Labels, shrink sleeves: THM MMP ROLLER 115 (1357420000)



Simplified removal of THM WO-Q and THM WO-QX markers due to the special contour of the carrier material

### Your benefits with THM WriteOn

- Quick and easy labelling.
- Marking protected against dirt and abrasion by attaching the transparent adhesive strip
- Vereinfachte Vereinzelnung
- Ein Markierer für viele Leiterdurchmesser
- Available on reels for thermal transfer printers and in DIN A4 sheets for laser printers

## THM WriteOn

## Technical data

Material	Temperature range	Fire class acc. to UL 94	Adhesive	Order No.	Type
Polyester film	-40...150 °C	V-0	Polyacrylate adhesive	<b>2005070000</b>	RIBBON MM 110/360 SW

## Ordering data

Order No.	Type	Colour	Height	Width	Qty.
1856630000	THM WO 12/18 GE	● yellow	12 mm	18 mm	1
1856640000	THM WO 12/18 WS	○ white	12 mm	18 mm	1
2621530000	THM WO 14/22 WS	○ white	14 mm	22 mm	5000
1429450000	THM WO 15/140 WS	○ white	15 mm	140 mm	1
1429440000	THM WO 15/70 WS	○ white	15 mm	70 mm	1
1774380000	THM WO 17.8/34 WS	○ white	17.8 mm	33.9 mm	1
2621500000	THM WO 20/32 WS	○ white	20 mm	32 mm	3000
2004970000	THM WO 24.5/100 WS	○ white	25.4 mm	100 mm	2000
1109130000	THM WO 24.5/62 WS	○ white	24.5 mm	62 mm	1
2621520000	THM WO 24/69 WS	○ white	24 mm	69 mm	1000
2621510000	THM WO 25/37 WS	○ white	25 mm	37 mm	2500
1109140000	THM WO 25.4/95.2 WS	○ white	25.4 mm	95.2 mm	1
1751561687	THM WO 25/140 GE	● yellow	25 mm	140 mm	1
1751561044	THM WO 25/140 WS	○ white	25 mm	140 mm	1
1774340000	THM WO 25/76 GE	● yellow	25 mm	76 mm	1
1774350000	THM WO 25/76 WS	○ white	25 mm	76 mm	1
2711990000	THM WO 25.4/93 WS	○ white	25.4 mm	93 mm	500
1774410000	THM WO 33.5/93.1 GE	● yellow	33.5 mm	93.1 mm	1
1774400000	THM WO 33.5/93.1 WS	○ white	33.5 mm	93.1 mm	1
1109190000	THM WO 50.8/150 BL	● blue	50.8 mm	150 mm	1
1109180000	THM WO 50.8/150 GE	● yellow	50.8 mm	150 mm	1
1109170000	THM WO 50.8/150 RT	● red	50.8 mm	150 mm	1
1109150000	THM WO 50.8/150 WS	○ white	50.8 mm	150 mm	1
1934190000	THM WO 51/36 WS	○ white	50.8 mm	36 mm	1



## THM WriteOn Q - for quick stripping

## Technical data

Material	Temperature range	Fire class acc. to UL 94	Adhesive	Order No.	Type
Polyester film	-40...150 °C	V-0	Polyacrylate adhesive	<b>2005080000</b>	RIBBON MM 76/360 SW
				<b>2005070000</b>	RIBBON MM 110/360 SW

## Ordering data

Order No.	Type	Colour	Height	Width	Qty.
2711870000	THM WO-Q 25/19.1 WS	○ white	25 mm	19.1 mm	1000
2711880000	THM WO-Q 25/31.8 WS	○ white	25 mm	31.8 mm	1000
2711890000	THM WO-Q 25/38.1 WS	○ white	25 mm	38.1 mm	1000
2711900000	THM WO-Q 25/51.4 WS	○ white	25 mm	51.4 mm	1000
2711960000	THM WO-QX 25/38.1WS	○ white	25 mm	38.1 mm	1000
2711950000	THM WO-QX 25/100 WS	○ white	25 mm	100 mm	1000

THM WriteOn QX with perforated protective foil

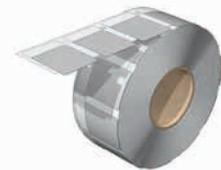

## THM WriteOn - Tedlar

## Technical data

Material	Temperature range	Fire class acc. to UL 94	Adhesive	Order No.	Type
Tedlar polyvinyl fluoride film®	-40...107 °C	V-0	Polyacrylate adhesive	<b>2005070000</b>	RIBBON MM 110/360 SW

## Ordering data

Order No.	Type	Colour	Height	Width	Qty.
1003380000	THM WO T 24.5/100 WS	○ white	24.5 mm	100 mm	1
1003420000	THM WO T 24.5/62 WS	○ white	24.5 mm	62 mm	1



THM WriteOn - Vinyl

Technical data

Material	Temperature range	Fire class acc. to UL 94	Adhesive	Order No.	Type
Vinyl film	-40...80 °C	V-0	Polyacrylate adhesive	<b>2005070000</b>	RIBBON MM 110/360 SW

Ordering data

Order No.	Type	Colour	Height	Width	Qty.
1382940000	THM WO VIN 12/18 WS	○ white	12 mm	18 mm	1
2657100000	THM WO VIN 12.7/19 WS	○ white	12.7 mm	19.1 mm	10000
2657110000	THM WO VIN 12.7/38.1 WS	○ white	12.7 mm	38.1 mm	10000
1382930000	THM WO VIN 17.8/34 WS	○ white	17.8 mm	34 mm	1
1391430000	THM WO VIN 24.5/100 WS	○ white	24.5 mm	100 mm	1
1391410000	THM WO VIN 24.5/62 WS	○ white	24.5 mm	62 mm	1
1253150000	THM WO VIN 25/25 WS	○ white	25 mm	25 mm	1
2657130000	THM WO VIN 25.4/19 SP WS	○ white	25.4 mm	19 mm	400
2657120000	THM WO VIN 25.4/19 WS	○ white	25.4 mm	19 mm	2000
2657150000	THM WO VIN 25.4/31.8 SP WS	○ white	25.4 mm	31.8 mm	400
2657140000	THM WO VIN 25.4/31.8 WS	○ white	25.4 mm	31.8 mm	2000
1110600000	THM WO VIN 25.4/36.5 WS IW	○ white	25.4 mm	36.5 mm	1
2625560000	THM WO VIN 25.4/36.5 GE IW	● yellow	25.4 mm	36.5 mm	2500
2657170000	THM WO VIN 25.4/38.1 SP WS	○ white	25.4 mm	38.1 mm	400
2657160000	THM WO VIN 25.4/38.1 WS	○ white	25.4 mm	38.1 mm	2000
2657190000	THM WO VIN 25.4/57.2 SP WS	○ white	25.4 mm	57.2 mm	400
2657180000	THM WO VIN 25.4/57.2 WS	○ white	25.4 mm	57.2 mm	2000
2657210000	THM WO VIN 25.4/63.5 SP WS	○ white	25.4 mm	63.5 mm	400
2657200000	THM WO VIN 25.4/63.5 WS	○ white	25.4 mm	63.5 mm	2000
1110610000	THM WO VIN 25.4/95.2 WS IW	○ white	25.4 mm	95.2 mm	1
1882900000	THM WO VIN 49.5/57.1 WS	○ white	49.53 mm	57.1 mm	1



THM WriteOn-Q VIN - for quick stripping

Technical data

Material	Temperature range	Fire class acc. to UL 94	Adhesive	Order No.	Type
Vinyl film	-40...80 °C	V-0	Polyacrylate adhesive	<b>2005080000</b>	RIBBON MM 76/360 SW
				<b>2005070000</b>	RIBBON MM 110/360 SW

Ordering data

Order No.	Type	Colour	Height	Width	Qty.
2711910000	THM WO-Q VIN 25/19.1 WS	○ white	25 mm	19.1 mm	1000
2711920000	THM WO-Q VIN 25/31.8 WS	○ white	25 mm	31.8 mm	1000
2711930000	THM WO-Q VIN 25/38.1 WS	○ white	25 mm	38.1 mm	1000
2711940000	THM WO-Q VIN 25/51.4 WS	○ white	25 mm	51.4 mm	1000
2711980000	THM WO-QX VIN 25/38.1 WS	○ white	25 mm	38.1 mm	1000
2711970000	THM WO-QX VIN 25/100 WS	○ white	25 mm	100 mm	1000

THM WO-QX VIN with perforated protective foil



## LM WO

## Technical data

Material	Temperature range	Fire class acc. to UL 94	Adhesive
Polyester film	-40 °C...150 °C	V-0	Acrylate

## Ordering data

Order No.	Type	Colour	Labelling field	Wire O.D.	Qty.
1773880000	LM WO 15/140 WS	○	white 15 x 70 mm	16.2 - 36.4 mm	260
1759871044	LM WO 15/70 WS	○	white 15 x 30 mm	8.2 - 14.3 mm	520
1695711687	LM WO 18/34 GE	●	yellow 18 x 12.7 mm	5 - 7 mm	880
1695711044	LM WO 18/34 WS	○	white 18 x 12.7 mm	5 - 7 mm	880
1695721687	LM WO 23/55 GE	●	yellow 23 x 12.7 mm	6.8 - 12 mm	400
1695721044	LM WO 23/55 WS	○	white 23 x 12.7 mm	6.8 - 12 mm	400
1768390000	LM WO 25.4/57 GE	●	yellow 25.4 x 18 mm	6.8 - 12 mm	350
1768380000	LM WO 25.4/57 WS	○	white 25.4 x 18 mm	5.9 - 12.3 mm	350
1768400000	LM WO 25.4/95 WS	○	white 25.4 x 25 mm	8 - 22 mm	210
1712491687	LM WO 25/140 GE	●	yellow 25 x 26 mm	16.2 - 36.4 mm	160
1712491044	LM WO 25/140 WS	○	white 25 x 26 mm	16.2 - 36.4 mm	160
1695731687	LM WO 25/68 GE	●	yellow 25 x 17 mm	8.2 - 14.3 mm	280
1695731044	LM WO 25/68 WS	○	white 25 x 17 mm	8.2 - 14.3 mm	280
1695741687	LM WO 36/93 GE	●	yellow 36 x 25 mm	9.5 - 22.3 mm	150
1695741044	LM WO 36/93 WS	○	white 36 x 25 mm	9.5 - 22.3 mm	150
1768430000	LM WO 37/25 GE	●	yellow 37 x 8 mm	3.4 - 4.8 mm	550



# MultMark shrink sleeves

## For you at a glance

### Identify cables and wires in confined spaces

For a long time now, clear and durable identification of your plant's modules, electrical components, wires and cables has not only been an absolute must but also highly important with respect to maintenance and troubleshooting. Labelling using shrink sleeves is one very common way of identifying wires and cables.

For example, shrink sleeves are actually the most common form of marker used for identification purposes in the railway industry. In this industry, an essential consideration is the stringent requirements regarding flammability characteristics. With our shrink sleeves, we meet the need for a labelling solution that satisfies the most stringent requirements set down in the CEN/TS 45545-2 HL3 standard.

In applications where space is at a premium, shrink sleeves offer a compact marking solution, for example when wiring multi pole plug in. Our new endless shrink sleeves offer customised design opportunities.

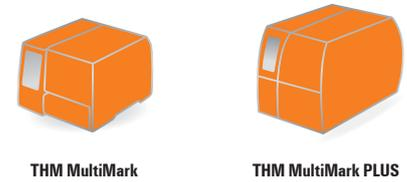

THM MultiMark

THM MultiMark PLUS

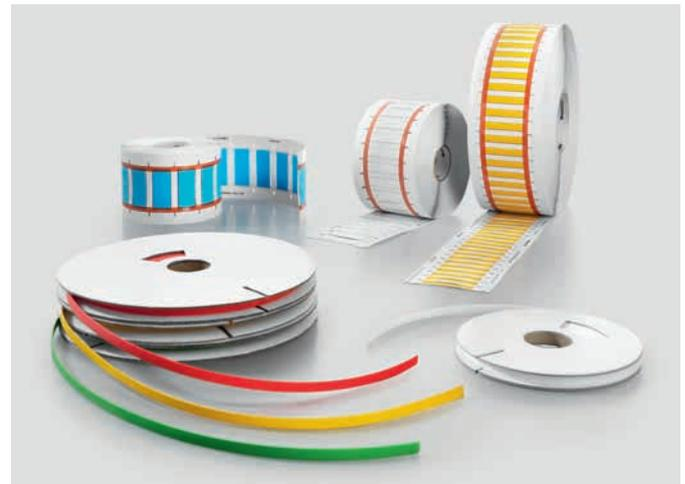

All materials are printed in a customised manner in combination with the intuitive M-Print® PRO labelling software.

### Technical data HS-HF, HSS-HF, HSS-HF EL

Material	Polyolefin, halogenfrei
Flammability Rating	ASTM D 635-HB EN 45545-2 HL 3
Temperature range	-55 °C to 105 °C
Rate of shrinkage	2:1
Recom. shrink temperature	90 °C
Ink ribbon organised	2448880000, RIBBON MM-HS 60/300 SW
Ink ribbon endless	1426210000, RIBBON HSS HF EL 40/300

### Technical data HS, HSS EL

Material	Polyolefin
Flammability Rating	UL 224 VW-1
Temperature range	- 55 °C to 135 °C
Rate of shrinkage	3:1
Recom. shrink temperature	90 °C
Ink ribbon organised	2448880000, RIBBON MM-HS 60/300 SW
Ink ribbon endless	1426210000, RIBBON HSS HF EL 40/300

### Technical data HS-FR

Material	Polyolefin
Flammability Rating	EN 45545-HL2
Temperature range	- 55 °C to 125 °C
Rate of shrinkage	2:1
Recom. shrink temperature	90 °C
Ink ribbon organised	2448880000, RIBBON MM-HS 60/300 SW



### Ordering data

Possible printing systems	THM MultiMark, THM MultiMark PLUS
Ink ribbon organised	2448880000, RIBBON MM-HS 60/300 SW (black) 2005040000 RIBBON MM 80/300 WS (white)
Ink ribbon endless	1426210000, RIBBON HSS HF EL 40/300 SW (black)
Pressure roller	Labels, shrink sleeves: THM MMP ROLLER 115 (1357420000)

### Your benefits with MultiMark shrink sleeves

- Configure markers the simple way with the M-Print® PRO labelling software
- Convenient assembly due to perforation of endless markers
- Time-saving installation thanks to simple handling
- Comply with common standards by using resistant markers

## HS ... 12.7 mm

## Technical data

Material	Rate of shrinkage	Temperature range	recom. Shrinks.	Order No.	Type
Polyolefine	3:1	-55...135 °C	90 °C	2448880000	RIBBON MM-HS 60/300 SW

## Ordering data

Order No.	Type	Colour	Height	Wire O.D.	Qty.
2526030000	HS 0.8-2.4/12 MM W	○ white	12.7 mm	0.8 - 2.4 mm	4000
2526060000	HS 0.8-2.4/12 MM Y	● yellow	12.7 mm	0.8 - 2.4 mm	4000
2526070000	HS 1.0-3.2/12 MM W	○ white	12.7 mm	1 - 3.2 mm	4000
2526080000	HS 1.0-3.2/12 MM Y	● yellow	12.7 mm	1 - 3.2 mm	4000
2526090000	HS 1.6-4.8/12 MM W	○ white	12.7 mm	1.6 - 4.8 mm	4000
2526100000	HS 1.6-4.8/12 MM Y	● yellow	12.7 mm	1.6 - 4.8 mm	4000
2526110000	HS 2.1-6.4/12 MM W	○ white	12.7 mm	2.1 - 6.4 mm	4000
2526120000	HS 2.1-6.4/12 MM Y	● yellow	12.7 mm	2.1 - 6.4 mm	4000
2526130000	HS 3.2-9.5/12 MM W	○ white	12.7 mm	3.2 - 9.5 mm	4000
2526140000	HS 3.2-9.5/12 MM Y	● yellow	12.7 mm	3.2 - 9.5 mm	2000
2526150000	HS 4.2-12.7/12 MM W	○ white	12.7 mm	4.2 - 12.7 mm	2000
2526160000	HS 4.2-12.7/12 MM Y	● yellow	12.7 mm	4.2 - 12.7 mm	2000

## HS...25.4 mm

## Technical data

Material	Rate of shrinkage	Temperature range	recom. Shrinks.	Order No.	Type
Polyolefine	3:1	-55...135 °C	90 °C	2448880000	RIBBON MM-HS 60/300 SW

## Ordering data

Order No.	Type	Colour	Height	Wire O.D.	Qty.
2437470000	HS 0.8-2.4/25 MM W	○ white	25.4 mm	0.8 - 2.4 mm	2000
2437480000	HS 0.8-2.4/25 MM Y	● yellow	25.4 mm	0.8 - 2.4 mm	2000
2437510000	HS 1.0-3.2/25 MM W	○ white	25.4 mm	1 - 3.2 mm	2000
2437520000	HS 1.0-3.2/25 MM Y	● yellow	25.4 mm	1 - 3.2 mm	2000
2437550000	HS 1.6-4.8/25 MM W	○ white	25.4 mm	1.6 - 4.8 mm	2000
2437560000	HS 1.6-4.8/25 MM Y	● yellow	25.4 mm	1.6 - 4.8 mm	2000
2437630000	HS 2.1-6.4/25 MM W	○ white	25.4 mm	2.1 - 6.4 mm	2000
2437640000	HS 2.1-6.4/25 MM Y	● yellow	25.4 mm	2.1 - 6.4 mm	2000
2437670000	HS 3.2-9.5/25 MM W	○ white	25.4 mm	3.2 - 9.5 mm	1000
2437680000	HS 3.2-9.5/25 MM Y	● yellow	25.4 mm	3.2 - 9.5 mm	1000
2437710000	HS 4.2-12.7/25 MM W	○ white	25.4 mm	4.2 - 12.7 mm	1000
2437720000	HS 4.2-12.7/25 MM Y	● yellow	25.4 mm	4.2 - 12.7 mm	1000
2437750000	HS 6.4-19.1/25 MM W	○ white	25.4 mm	6.4 - 19.1 mm	800
2437760000	HS 6.4-19.1/25 MM Y	● yellow	25.4 mm	6.4 - 19.1 mm	800
2437790000	HS 8.5-25.4/25 MM W	○ white	25.4 mm	8.5 - 25.4 mm	400
2437800000	HS 8.5-25.4/25 MM Y	● yellow	25.4 mm	8.5 - 25.4 mm	400
2437590000	HS 12.7-38.1/25 MM W	○ white	25.4 mm	12.7 - 38.1 mm	200
2437600000	HS 12.7-38.1/25 MM Y	● yellow	25.4 mm	12.7 - 38.1 mm	200



## Wire and cable markers – shrink sleeves

## HS...50.8 mm

## Technical data

Material	Rate of shrinkage	Temperature range	recom. Shrinks.	Order No.	Type
Polyolefine	3:1	-55...135 °C	90 °C	<b>2448880000</b>	RIBBON MM-HS 60/300 SW

## Ordering data

Order No.	Type	Colour	Height	Wire O.D.	Qty.
2437490000	HS 0.8-2.4/50 MM W	○ white	50.8 mm	0.8 - 2.4 mm	1000
2437500000	HS 0.8-2.4/50 MM Y	● yellow	50.8 mm	0.8 - 2.4 mm	1000
2437530000	HS 1.0-3.2/50 MM W	○ white	50.8 mm	1 - 3.2 mm	1000
2437540000	HS 1.0-3.2/50 MM Y	● yellow	50.8 mm	1 - 3.2 mm	1000
2437570000	HS 1.6-4.8/50 MM W	○ white	50.8 mm	1.6 - 4.8 mm	1000
2437580000	HS 1.6-4.8/50 MM Y	● yellow	50.8 mm	1.6 - 4.8 mm	1000
2437650000	HS 2.1-6.4/50 MM W	○ white	50.8 mm	2.1 - 6.4 mm	1000
2437660000	HS 2.1-6.4/50 MM Y	● yellow	50.8 mm	2.1 - 6.4 mm	1000
2437690000	HS 3.2-9.5/50 MM W	○ white	50.8 mm	3.2 - 9.5 mm	500
2437700000	HS 3.2-9.5/50 MM Y	● yellow	50.8 mm	3.2 - 9.5 mm	500
2437730000	HS 4.2-12.7/50 MM W	○ white	50.8 mm	4.2 - 12.7 mm	500
2437740000	HS 4.2-12.7/50 MM Y	● yellow	50.8 mm	4.2 - 12.7 mm	500
2437770000	HS 6.4-19.1/50 MM W	○ white	50.8 mm	6.4 - 19.1 mm	400
2437780000	HS 6.4-19.1/50 MM Y	● yellow	50.8 mm	6.4 - 19.1 mm	400
2437810000	HS 8.5-25.4/50 MM W	○ white	50.8 mm	8.5 - 25.4 mm	200
2437820000	HS 8.5-25.4/50 MM Y	● yellow	50.8 mm	8.5 - 25.4 mm	200
2437610000	HS 12.7-38.1/50 MM W	○ white	50.8 mm	12.7 - 38.1 mm	100
2437620000	HS 12.7-38.1/50 MM Y	● yellow	50.8 mm	12.7 - 38.1 mm	100



## HS-HF 12.7 mm halogen-free

## Technical data

Material	Rate of shrinkage	Temperature range	recom. Shrinks.	Order No.	Type
Polyolefine	2:1	-55...105 °C	90 °C	<b>2448880000</b>	RIBBON MM-HS 60/300 SW

## Ordering data

Order No.	Type	Colour	Height	Wire O.D.	Qty.
2526230000	HS-HF 1.2-2.4/12 MM W	○ white	12.7 mm	1.2 - 2.4 mm	4000
2526240000	HS-HF 1.2-2.4/12 MM Y	● yellow	12.7 mm	1.2 - 2.4 mm	4000
2526250000	HS-HF 1.6-3.2/12 MM W	○ white	12.7 mm	1.6 - 3.2 mm	4000
2526260000	HS-HF 1.6-3.2/12 MM Y	● yellow	12.7 mm	1.6 - 3.2 mm	4000
2526270000	HS-HF 2.4-4.8/12 MM W	○ white	12.7 mm	2.4 - 4.8 mm	4000
2526280000	HS-HF 2.4-4.8/12 MM Y	● yellow	12.7 mm	2.4 - 4.8 mm	4000
2526290000	HS-HF 3.2-6.4/12 MM W	○ white	12.7 mm	3.2 - 6.4 mm	4000
2526300000	HS-HF 3.2-6.4/12 MM Y	● yellow	12.7 mm	3.2 - 6.4 mm	4000
2526310000	HS-HF 4.8-9.5/12 MM W	○ white	12.7 mm	4.8 - 9.5 mm	2000
2526320000	HS-HF 4.8-9.5/12 MM Y	● yellow	12.7 mm	4.8 - 9.5 mm	2000
2526330000	HS-HF 6.4-12.7/12 MM W	○ white	12.7 mm	6.4 - 12.7 mm	2000
2526340000	HS-HF 6.4-12.7/12 MM Y	● yellow	12.7 mm	6.4 - 12.7 mm	2000





## HS-HF 25.4 mm halogen-free

## Technical data

Material	Rate of shrinkage	Temperature range	recom. Shrinks.	Order No.	Type
Polyolefine	2:1	-55...105 °C	90 °C	2448880000	RIBBON MM-HS 60/300 SW

## Ordering data

Order No.	Type	Colour	Height	Wire O.D.	Qty.
2437830000	HS-HF 1.2-2.4/25 MM W	white	25.4 mm	1.2 - 2.4 mm	2000
2437840000	HS-HF 1.2-2.4/25 MM Y	yellow	25.4 mm	1.2 - 2.4 mm	2000
2437870000	HS-HF 1.6-3.2/25 MM W	white	25.4 mm	1.6 - 3.2 mm	2000
2437880000	HS-HF 1.6-3.2/25 MM Y	yellow	25.4 mm	1.6 - 3.2 mm	2000
2437990000	HS-HF 2.4-4.8/25 MM W	white	25.4 mm	2.4 - 4.8 mm	2000
2438000000	HS-HF 2.4-4.8/25 MM Y	yellow	25.4 mm	2.4 - 4.8 mm	2000
2438030000	HS-HF 3.2-6.4/25 MM B	blue	25.4 mm	3.2 - 6.4 mm	2000
2438040000	HS-HF 3.2-6.4/25 MM W	white	25.4 mm	3.2 - 6.4 mm	2000
2438050000	HS-HF 3.2-6.4/25 MM Y	yellow	25.4 mm	3.2 - 6.4 mm	2000
2438080000	HS-HF 4.8-9.5/25 MM B	blue	25.4 mm	4.8 - 9.5 mm	1000
2438090000	HS-HF 4.8-9.5/25 MM W	white	25.4 mm	4.8 - 9.5 mm	1000
2438100000	HS-HF 4.8-9.5/25 MM Y	yellow	25.4 mm	4.8 - 9.5 mm	1000
2438130000	HS-HF 6.4-12.7/25 MM B	blue	25.4 mm	6.4 - 12.7 mm	1000
2438140000	HS-HF 6.4-12.7/25 MM W	white	25.4 mm	6.4 - 12.7 mm	1000
2438150000	HS-HF 6.4-12.7/25 MM Y	yellow	25.4 mm	6.4 - 12.7 mm	1000
2438180000	HS-HF 9.5-19.1/25 MM R	red	25.4 mm	9.5 - 19.1 mm	800
2438190000	HS-HF 9.5-19.1/25 MM W	white	25.4 mm	9.5 - 19.1 mm	800
2438200000	HS-HF 9.5-19.1/25 MM Y	yellow	25.4 mm	9.5 - 19.1 mm	800
2437910000	HS-HF 12.7-25.4/25 MM W	white	25.4 mm	12.7 - 25.4 mm	400
2437920000	HS-HF 12.7-25.4/25 MM Y	yellow	25.4 mm	12.7 - 25.4 mm	400
2437950000	HS-HF 19.5-38.1/25 MM W	white	25.4 mm	19.5 - 38.1 mm	200
2437960000	HS-HF 19.5-38.1/25 MM Y	yellow	25.4 mm	19.5 - 38.1 mm	200

## HS-HF 50.8 mm halogen-free

## Technical data

Material	Rate of shrinkage	Temperature range	recom. Shrinks.	Order No.	Type
Polyolefine	2:1	-55...105 °C	90 °C	2448880000	RIBBON MM-HS 60/300 SW

## Ordering data

Order No.	Type	Colour	Height	Wire O.D.	Qty.
2437850000	HS-HF 1.2-2.4/50 MM W	white	50.8 mm	1.2 - 2.4 mm	1000
2437860000	HS-HF 1.2-2.4/50 MM Y	yellow	50.8 mm	1.2 - 2.4 mm	1000
2437890000	HS-HF 1.6-3.2/50 MM W	white	50.8 mm	1.6 - 3.2 mm	1000
2437900000	HS-HF 1.6-3.2/50 MM Y	yellow	50.8 mm	1.6 - 3.2 mm	1000
2438010000	HS-HF 2.4-4.8/50 MM W	white	50.8 mm	2.4 - 4.8 mm	1000
2438020000	HS-HF 2.4-4.8/50 MM Y	yellow	50.8 mm	2.4 - 4.8 mm	1000
2438060000	HS-HF 3.2-6.4/50 MM W	white	50.8 mm	3.2 - 6.4 mm	1000
2438070000	HS-HF 3.2-6.4/50 MM Y	yellow	50.8 mm	3.2 - 6.4 mm	1000
2438110000	HS-HF 4.8-9.5/50 MM W	white	50.8 mm	4.8 - 9.5 mm	500
2438120000	HS-HF 4.8-9.5/50 MM Y	yellow	50.8 mm	4.8 - 9.5 mm	500
2438160000	HS-HF 6.4-12.7/50 MM W	white	50.8 mm	6.4 - 12.7 mm	500
2438170000	HS-HF 6.4-12.7/50 MM Y	yellow	50.8 mm	6.4 - 12.7 mm	500
2438210000	HS-HF 9.5-19.1/50 MM W	white	50.8 mm	9.5 - 19.1 mm	400
2438220000	HS-HF 9.5-19.1/50 MM Y	yellow	50.8 mm	9.5 - 19.1 mm	400
2437930000	HS-HF 12.7-25.4/50 MM W	white	50.8 mm	12.7 - 25.4 mm	200
2437940000	HS-HF 12.7-25.4/50 MM Y	yellow	50.8 mm	12.7 - 25.4 mm	200
2437970000	HS-HF 19.5-38.1/50 MM W	white	50.8 mm	19.5 - 38.1 mm	100
2437980000	HS-HF 19.5-38.1/50 MM Y	yellow	50.8 mm	19.5 - 38.1 mm	100

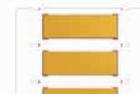
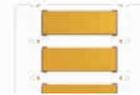

## Wire and cable markers – shrink sleeves

## HS-FR... 25.4 - in accordance with DIN EN 50343 Annex H

## Technical data

Material	Rate of shrinkage	Temperature range	recom. Shrinks.	Order No.	Type
Polyolefine	2:1	-55...125 °C	90 °C	2448880000	RIBBON MM-HS 60/300 SW

## Ordering data

Order No.	Type	Colour	Height	Wire O.D.	Qty.
2621560000	HS-FR 1.2-2.4/25 MM W	○ white	24.9 mm	1.2 - 2.4 mm	2000
2621570000	HS-FR 1.2-2.4/25 MM Y	● yellow	24.9 mm	1.2 - 2.4 mm	2000
2621580000	HS-FR 1.6-3.2/25 MM W	○ white	24.9 mm	1.6 - 3.2 mm	2000
2621590000	HS-FR 1.6-3.2/25 MM Y	● yellow	24.9 mm	1.6 - 3.2 mm	2000
2621600000	HS-FR 2.4-4.8/25 MM W	○ white	24.9 mm	2.4 - 4.8 mm	2000
2621610000	HS-FR 2.4-4.8/25 MM Y	● yellow	24.9 mm	2.4 - 4.8 mm	2000
2621620000	HS-FR 3.2-6.4/25 MM W	○ white	24.9 mm	3.2 - 6.4 mm	2000
2621630000	HS-FR 3.2-6.4/25 MM Y	● yellow	24.9 mm	3.2 - 6.4 mm	2000
2621640000	HS-FR 4.8-9.5/25 MM W	○ white	24.9 mm	4.8 - 9.5 mm	1000
2621650000	HS-FR 4.8-9.5/25 MM Y	● yellow	24.9 mm	4.8 - 9.5 mm	1000
2621660000	HS-FR 6.4-12.7/25 MM W	○ white	24.9 mm	6.4 - 12.7 mm	1000
2621670000	HS-FR 6.4-12.7/25 MM Y	● yellow	24.9 mm	6.4 - 12.7 mm	1000
2621680000	HS-FR 9.5-19.1/25 MM W	○ white	24.9 mm	9.5 - 19.1 mm	800
2621690000	HS-FR 9.5-19.1/25 MM Y	● yellow	24.9 mm	9.5 - 19.1 mm	800
2621700000	HS-FR 12.7-25.4/25 MM W	○ white	24.9 mm	12.7 - 25.4 mm	600
2621710000	HS-FR 12.7-25.4/25 MM Y	● yellow	24.9 mm	12.7 - 25.4 mm	600
2621720000	HS-FR 19.1-38.1/25 MM W	○ white	24.9 mm	19.1 - 38.1 mm	200
2621730000	HS-FR 19.1-38.1/25 MM Y	● yellow	24.9 mm	19.1 - 38.1 mm	200

## HS-FR... 50.8 - in accordance with DIN EN 50343 Annex H

## Technical data

Material	Rate of shrinkage	Temperature range	recom. Shrinks.	Order No.	Type
Polyolefine	2:1	-55...125 °C	90 °C	2448880000	RIBBON MM-HS 60/300 SW

## Ordering data

Order No.	Type	Colour	Height	Wire O.D.	Qty.
2621740000	HS-FR 1.2-2.4/50 MM W	○ white	49.8 mm	1.2 - 2.4 mm	1000
2621750000	HS-FR 1.2-2.4/50 MM Y	● yellow	49.8 mm	1.2 - 2.4 mm	1000
2621760000	HS-FR 1.6-3.2/50 MM W	○ white	49.8 mm	1.6 - 3.2 mm	1000
2621770000	HS-FR 1.6-3.2/50 MM Y	● yellow	49.8 mm	1.6 - 3.2 mm	1000
2621780000	HS-FR 2.4-4.8/50 MM W	○ white	49.8 mm	2.4 - 4.8 mm	1000
2621790000	HS-FR 2.4-4.8/50 MM Y	● yellow	49.8 mm	2.4 - 4.8 mm	1000
2621800000	HS-FR 3.2-6.4/50 MM W	○ white	49.8 mm	3.2 - 6.4 mm	1000
2621810000	HS-FR 3.2-6.4/50 MM Y	● yellow	49.8 mm	3.2 - 6.4 mm	1000
2621820000	HS-FR 4.8-9.5/50 MM W	○ white	49.8 mm	4.8 - 9.5 mm	500
2621830000	HS-FR 4.8-9.5/50 MM Y	● yellow	49.8 mm	4.8 - 9.5 mm	500
2621840000	HS-FR 6.4-12.7/50 MM W	○ white	49.8 mm	6.4 - 12.7 mm	500
2621850000	HS-FR 6.4-12.7/50 MM Y	● yellow	49.8 mm	6.4 - 12.7 mm	500
2621860000	HS-FR 9.5-19.1/50 MM W	○ white	49.8 mm	9.5 - 19.1 mm	400
2621870000	HS-FR 9.5-19.1/50 MM Y	● yellow	49.8 mm	9.5 - 19.1 mm	400
2621880000	HS-FR 12.7-25.4/50 MM W	○ white	49.8 mm	12.7 - 25.4 mm	300
2621890000	HS-FR 12.7-25.4/50 MM Y	● yellow	49.8 mm	12.7 - 25.4 mm	300
2621900000	HS-FR 19.1-38.1/50 MM W	○ white	49.8 mm	19.1 - 38.1 mm	100
2621910000	HS-FR 19.1-38.1/50 MM Y	● yellow	49.8 mm	19.1 - 38.1 mm	100

## HSS... Endless 10 meters

## Technical data

Material	Rate of shrinkage	Temperature range	recom. Shrinks.	Order No.	Type
Polyolefine	3:1	-55...135 °C	90 °C	1426210000	RIBBON HSS HF EL 40/300

## Ordering data

Order No.	Type	Colour	Length	Wire O.D.	Qty.
1489680000	HSS 6.4-19.1 EL W10M	○ white	10000 mm	6.4 - 19.1 mm	1
1489690000	HSS 6.4-19.1 EL Y10M	● yellow	10000 mm	6.4 - 19.1 mm	1
1489690000	HSS 8.5-25.4 EL W10M	○ white	10000 mm	8.5 - 25.4 mm	1
1489610000	HSS 8.5-25.4 EL Y10M	● yellow	10000 mm	8.5 - 25.4 mm	1

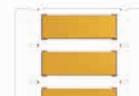
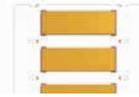

## HSS... Endless 13 meters

## Technical data

Material	Rate of shrinkage	Temperature range	recom. Shrinks.	Order No.	Type
Polyolefine	3:1	-55...135 °C	90 °C	1426210000	RIBBON HSS HF EL 40/300

## Ordering data

Order No.	Type	Colour	Length	Wire O.D.	Qty.
1489620000	HSS 0.8-2.4 EL W13M	white	13000 mm	0.8 - 2.4 mm	1
1489530000	HSS 0.8-2.4 EL Y13M	yellow	13000 mm	0.8 - 2.4 mm	1
1489630000	HSS 1.0-3.2 EL W13M	white	13000 mm	1 - 3.2 mm	1
1489540000	HSS 1.0-3.2 EL Y13M	yellow	13000 mm	1 - 3.2 mm	1
1489640000	HSS 1.6-4.8 EL W13M	white	13000 mm	1.6 - 4.8 mm	1
1489550000	HSS 1.6-4.8 EL Y13M	yellow	13000 mm	1.6 - 4.8 mm	1
1489650000	HSS 2.1-6.4 EL W13M	white	13000 mm	2.1 - 6.4 mm	1
1489560000	HSS 2.1-6.4 EL Y13M	yellow	13000 mm	2.1 - 6.4 mm	1
1489660000	HSS 3.2-9.5 EL W13M	white	13000 mm	3.2 - 9.5 mm	1
1489570000	HSS 3.2-9.5 EL Y13M	yellow	13000 mm	3.2 - 9.5 mm	1
1489670000	HSS 4.2-12.7 EL W13M	white	13000 mm	4.2 - 12.7 mm	1
1489580000	HSS 4.2-12.7 EL Y13M	yellow	13000 mm	4.2 - 12.7 mm	1

## HSS... Endless 30 meters

## Technical data

Material	Rate of shrinkage	Temperature range	recom. Shrinks.	Order No.	Type
Polyolefine	3:1	-55...135 °C	90 °C	1426210000	RIBBON HSS HF EL 40/300

## Ordering data

Order No.	Type	Colour	Length	Wire O.D.	Qty.
1505840000	HSS 0.8-2.4 EL W30M	white	30000 mm	0.8 - 2.4 mm	1
1505760000	HSS 0.8-2.4 EL Y30M	yellow	30000 mm	0.8 - 2.4 mm	1
1505850000	HSS 1.0-3.2 EL W30M	white	30000 mm	1 - 3.2 mm	1
1505770000	HSS 1.0-3.2 EL Y30M	yellow	30000 mm	1 - 3.2 mm	1
1505860000	HSS 1.6-4.8 EL W30M	white	30000 mm	1.6 - 4.8 mm	1
1505780000	HSS 1.6-4.8 EL Y30M	yellow	30000 mm	1.6 - 4.8 mm	1
1505870000	HSS 2.1-6.4 EL W30M	white	30000 mm	2.1 - 6.4 mm	1
1505790000	HSS 2.1-6.4 EL Y30M	yellow	30000 mm	2.1 - 6.4 mm	1
1505880000	HSS 3.2-9.5 EL W30M	white	30000 mm	3.2 - 9.5 mm	1
1505800000	HSS 3.2-9.5 EL Y30M	yellow	30000 mm	3.2 - 9.5 mm	1
1505890000	HSS 4.2-12.7 EL W30M	white	30000 mm	4.2 - 12.7 mm	1
1505810000	HSS 4.2-12.7 EL Y30M	yellow	30000 mm	4.2 - 12.7 mm	1
1505900000	HSS 6.4-19.1 EL W30M	white	30000 mm	6.4 - 19.1 mm	1
1505820000	HSS 6.4-19.1 EL Y30M	yellow	30000 mm	6.4 - 19.1 mm	1
1505910000	HSS 8.5-25.4 EL W30M	white	30000 mm	8.5 - 25.4 mm	1
1505830000	HSS 8.5-25.4 EL Y30M	yellow	30000 mm	8.5 - 25.4 mm	1

Note: External roll holder necessary

## HSS-HF... Halogen-free Endless 10 meters

## Technical data

Material	Rate of shrinkage	Temperature range	recom. Shrinks.	Order No.	Type
Polyolefine	2:1	-55...105 °C	90 °C	1426210000	RIBBON HSS HF EL 40/300

## Ordering data

Order No.	Type	Colour	Length	Wire O.D.	Qty.
1423390000	HSS-HF 9.5-19.1 EL W10M	white	10000 mm	9.5 - 19.1 mm	1
1423280000	HSS-HF 9.5-19.1 EL Y10M	yellow	10000 mm	9.5 - 19.1 mm	1
1423410000	HSS-HF 12.7-25.4EL W10M	white	10000 mm	12.7 - 25.4 mm	1
1423290000	HSS-HF 12.7-25.4EL Y10M	yellow	10000 mm	12.7 - 25.4 mm	1



## Wire and cable markers – shrink sleeves

## HSS-HF... Halogen-free Endless 13 meters

## Technical data

Material	Rate of shrinkage	Temperature range	recom. Shrinks.	Order No.	Type
Polyolefine	2:1	-55...105 °C	90 °C	<b>1426210000</b>	RIBBON HSS HF EL 40/300

## Ordering data

Order No.	Type		Colour	Length	Wire O.D.	Qty.
1423330000	HSS-HF 1.2-2.4 EL W13M	○	white	13000 mm	1.2 - 2.4 mm	1
1423220000	HSS-HF 1.2-2.4 EL Y13M	●	yellow	13000 mm	1.2 - 2.4 mm	1
1423340000	HSS-HF 1.6-3.2 EL W13M	○	white	13000 mm	1.6 - 3.2 mm	1
1423230000	HSS-HF 1.6-3.2 EL Y13M	●	yellow	13000 mm	1.6 - 3.2 mm	1
1423350000	HSS-HF 2.4-4.8 EL W13M	○	white	13000 mm	2.4 - 4.8 mm	1
1423240000	HSS-HF 2.4-4.8 EL Y13M	●	yellow	13000 mm	2.4 - 4.8 mm	1
1423360000	HSS-HF 3.2-6.4 EL W13M	○	white	13000 mm	3.2 - 6.4 mm	1
1423250000	HSS-HF 3.2-6.4 EL Y13M	●	yellow	13000 mm	3.2 - 6.4 mm	1
1423370000	HSS-HF 4.8-9.5 EL W13M	○	white	13000 mm	4.8 - 9.5 mm	1
1423260000	HSS-HF 4.8-9.5 EL Y13M	●	yellow	13000 mm	4.8 - 9.5 mm	1
1423380000	HSS-HF 6.4-12.7 EL W13M	○	white	13000 mm	6.4 - 12.7 mm	1
1423270000	HSS-HF 6.4-12.7 EL Y13M	●	yellow	13000 mm	6.4 - 12.7 mm	1



## HSS-HF... Halogen-free Endless 30 meters

## Technical data

Material	Rate of shrinkage	Temperature range	recom. Shrinks.	Order No.	Type
Polyolefine	2:1	-55...105 °C	90 °C	1426210000	RIBBON HSS HF EL 40/300
				2005040000	RIBBON MM 84/300 WS

## Ordering data

Order No.	Type	Colour	Length	Wire O.D.	Qty.
1562840000	HSS-HF 1.2-2.4 EL B30M	● blue	30000 mm	1.2 - 2.4 mm	1
2518740000	HSS-HF 1.2-2.4 EL SW30M	● black	30000 mm	1.2 - 2.4 mm	1
1562940000	HSS-HF 1.2-2.4 EL G30M	● green	30000 mm	1.2 - 2.4 mm	1
1562740000	HSS-HF 1.2-2.4 EL R30M	● red	30000 mm	1.2 - 2.4 mm	1
1513240000	HSS-HF 1.2-2.4 EL W30M	○ white	30000 mm	1.2 - 2.4 mm	1
1513140000	HSS-HF 1.2-2.4 EL Y30M	● yellow	30000 mm	1.2 - 2.4 mm	1
2518920000	HSS-HF 1.6-3.2 EL SW30M	● black	30000 mm	1.6 - 3.2 mm	1
1562850000	HSS-HF 1.6-3.2 EL B30M	● blue	30000 mm	1.6 - 3.2 mm	1
1562750000	HSS-HF 1.6-3.2 EL R30M	● red	30000 mm	1.6 - 3.2 mm	1
1562950000	HSS-HF 1.6-3.2 EL G30M	● green	30000 mm	1.6 - 3.2 mm	1
1513250000	HSS-HF 1.6-3.2 EL W30M	○ white	30000 mm	1.6 - 3.2 mm	1
1513150000	HSS-HF 1.6-3.2 EL Y30M	● yellow	30000 mm	1.6 - 3.2 mm	1
2518930000	HSS-HF 2.4-4.8 EL SW30M	● black	30000 mm	2.4 - 4.8 mm	1
1562870000	HSS-HF 2.4-4.8 EL B30M	● blue	30000 mm	2.4 - 4.8 mm	1
1562970000	HSS-HF 2.4-4.8 EL G30M	● green	30000 mm	2.4 - 4.8 mm	1
1562770000	HSS-HF 2.4-4.8 EL R30M	● red	30000 mm	2.4 - 4.8 mm	1
1513270000	HSS-HF 2.4-4.8 EL W30M	○ white	30000 mm	2.4 - 4.8 mm	1
1513170000	HSS-HF 2.4-4.8 EL Y30M	● yellow	30000 mm	2.4 - 4.8 mm	1
2518940000	HSS-HF 3.2-6.4 EL SW30M	● black	30000 mm	3.2 - 6.4 mm	1
1562880000	HSS-HF 3.2-6.4 EL B30M	● blue	30000 mm	3.2 - 6.4 mm	1
1562980000	HSS-HF 3.2-6.4 EL G30M	● green	30000 mm	3.2 - 6.4 mm	1
1562780000	HSS-HF 3.2-6.4 EL R30M	● red	30000 mm	3.2 - 6.4 mm	1
1513280000	HSS-HF 3.2-6.4 EL W30M	○ white	30000 mm	3.2 - 6.4 mm	1
1513180000	HSS-HF 3.2-6.4 EL Y30M	● yellow	30000 mm	3.2 - 6.4 mm	1
2518950000	HSS-HF 4.8-9.5 EL SW30M	● black	30000 mm	4.8 - 9.5 mm	1
1562890000	HSS-HF 4.8-9.5 EL B30M	● blue	30000 mm	4.8 - 9.5 mm	1
1562990000	HSS-HF 4.8-9.5 EL G30M	● green	30000 mm	4.8 - 9.5 mm	1
1562790000	HSS-HF 4.8-9.5 EL R30M	● red	30000 mm	4.8 - 9.5 mm	1
1513290000	HSS-HF 4.8-9.5 EL W30M	○ white	30000 mm	4.8 - 9.5 mm	1
1513190000	HSS-HF 4.8-9.5 EL Y30M	● yellow	30000 mm	4.8 - 9.5 mm	1
2518960000	HSS-HF 6.4-12.7 EL SW30M	● black	30000 mm	6.4 - 12.7 mm	1
1562900000	HSS-HF 6.4-12.7 EL B30M	● blue	30000 mm	6.4 - 12.7 mm	1
1563020000	HSS-HF 6.4-12.7 EL G30M	● green	30000 mm	6.4 - 12.7 mm	1
1562800000	HSS-HF 6.4-12.7 EL R30M	● red	30000 mm	6.4 - 12.7 mm	1
1513300000	HSS-HF 6.4-12.7 EL W30M	○ white	30000 mm	6.4 - 12.7 mm	1
1513200000	HSS-HF 6.4-12.7 EL Y30M	● yellow	30000 mm	6.4 - 12.7 mm	1
2518970000	HSS-HF 9.5-19.1 EL SW30M	● black	30000 mm	9.5 - 19.1 mm	1
1562920000	HSS-HF 9.5-19.1 EL B30M	● blue	30000 mm	9.5 - 19.1 mm	1
1563030000	HSS-HF 9.5-19.1 EL G30M	● green	30000 mm	9.5 - 19.1 mm	1
1562820000	HSS-HF 9.5-19.1 EL R30M	● red	30000 mm	9.5 - 19.1 mm	1
1513320000	HSS-HF 9.5-19.1 EL W30M	○ white	30000 mm	9.5 - 19.1 mm	1
1513220000	HSS-HF 9.5-19.1 EL Y30M	● yellow	30000 mm	9.5 - 19.1 mm	1
2518980000	HSS-HF 12.7-25.4EL SW30M	● black	30000 mm	12.7 - 25.4 mm	1
1562930000	HSS-HF 12.7-25.4EL B30M	● blue	30000 mm	12.7 - 25.4 mm	1
1563040000	HSS-HF 12.7-25.4EL G30M	● green	30000 mm	12.7 - 25.4 mm	1
1562830000	HSS-HF 12.7-25.4EL R30M	● red	30000 mm	12.7 - 25.4 mm	1
1513330000	HSS-HF 12.7-25.4EL W30M	○ white	30000 mm	12.7 - 25.4 mm	1
1513230000	HSS-HF 12.7-25.4EL Y30M	● yellow	30000 mm	12.7 - 25.4 mm	1

Note: External roll holder necessary

## HSS-HF... Halogen-free Endless 50 meters

## Technical data

Material	Rate of shrinkage	Temperature range	recom. Shrinks.	Order No.	Type
Polyolefine	2:1	-55...105 °C	90 °C	1426210000	RIBBON HSS HF EL 40/300

## Ordering data

Order No.	Type	Colour	Length	Wire O.D.	Qty.
1562720000	HSS-HF 9.5-19.1 EL Y50M	● yellow	50000 mm	9.5 - 19.1 mm	1
1562730000	HSS-HF 12.7-25.4EL Y50M	● yellow	50000 mm	12.7 - 25.4 mm	1

Note: External roll holder necessary



## Wire and cable markers – shrink sleeves

## HSS-HF... Halogen-free Endless 75 meters

## Technical data

Material	Rate of shrinkage	Temperature range	recom. Shrinks.	Order No.	Type
Polyolefine	2:1	-55...105 °C	90 °C	<b>1426210000</b>	RIBBON HSS HF EL 40/300

## Ordering data

Order No.	Type	Colour	Length	Wire O.D.	Qty.
<b>1562640000</b>	HSS-HF 1.2-2.4 EL Y75M	● yellow	75000 mm	1.2 - 2.4 mm	1
<b>1562650000</b>	HSS-HF 1.6-3.2 EL Y75M	● yellow	75000 mm	1.6 - 3.2 mm	1
<b>1562670000</b>	HSS-HF 2.4-4.8 EL Y75M	● yellow	75000 mm	2.4 - 4.8 mm	1
<b>1562680000</b>	HSS-HF 3.2-6.4 EL Y75M	● yellow	75000 mm	3.2 - 6.4 mm	1
<b>1562690000</b>	HSS-HF 4.8-9.5 EL Y75M	● yellow	75000 mm	4.8 - 9.5 mm	1
<b>1562700000</b>	HSS-HF 6.4-12.7 EL Y75M	● yellow	75000 mm	6.4 - 12.7 mm	1

Note: External roll holder necessary





# Device markers ESG, SM, CC and EL

## Make your systems secure

Nameplates, warning signs or functional labels for control and signaling equipment – device marking ensures that machinery and equipment is used correctly and is indispensable in the control cabinet.



THM MultiMark



THM MultiMark PLUS

### Longevity guaranteed: ESG

The multi-coloured and formatted labels have a strong adhesive layer to ensure the best possible adhesion to the underlying surface. Double laminated polyester makes the basic material very thin and yet extremely tear-resistant.

### Prevent incorrect operation: SM

MultiMark device markers can be used for identifying equipment from multiple manufacturers. In various areas of application they guarantee the clear assignment of all components, such as control and signaling devices from different vendors.

### Standard included: CC

Our systematically coordinated product range includes labels for identifying standard components, as well as all purpose and familiar formats: such as the CC 85/54 marker for creating nameplates.

### Customised Identification: EL

The endless variations of MultiMark markers make them an economical alternative to conventional tag rails or special labels. For any given width, the length can be precisely configured by the software to match the respective markers perfectly. A blade is used to cut the labels individually to the specified size.

#### Technical data MultiMark ESG, SM, CC, EL

Material	Double-laminated polyester
Material thickness	0.1 mm
Reverse side	Aluminised for all colours
Adhesive	extremely strong acrylic adhesive
Initial adhesion	950 gr./cm <sup>2</sup>



Always in the right place: the strong adhesive polyester labels are particularly suitable for labelling equipment.



Type plates are also easy to make with the CC markers and guarantee a secure hold on different surfaces.



#### Ordering data

Possible printing systems	THM MultiMark, THM MultiMark PLUS
Ink ribbon organised	2448880000, RIBBON MM-HS 60/300 SW (black) 2005040000 RIBBON MM 80/300 WS (white)
Ink ribbon endless	1426210000, RIBBON HSS HF EL 40/300 SW (black)
Pressure roller	Labels, shrink sleeves: THM MMP ROLLER 115 (1357420000)

#### Your benefits with MultiMark

- Double or single laminated polyester
- Can be used with the equipment of many manufacturers
- Device markers with a familiar design
- Delivered on rolls, also for small amounts for thermal transfer printers



Device markers ESG

Technical data

Material	Temperature range	Fire class acc. to UL 94	Adhesive	Order No.	Type
Polyester	-40...120 °C	V-0	Acrylate adhesive	<b>2005080000</b>	RIBBON MM 76/360 SW
				<b>2005040000</b>	RIBBON MM 84/300 WS

Ordering data

Order No.	Type	Colour	Height	Width	Qty.
2619950000	ESG 6/15 MM GE	● yellow	6 mm	15 mm	3000
2619960000	ESG 6/15 MM GR	● grey	6 mm	15 mm	3000
2619940000	ESG 6/15 MM WS	○ white	6 mm	15 mm	3000
2005110000	ESG 6/17 MM GE	● yellow	6 mm	17 mm	3000
2005120000	ESG 6/17 MM GR	● grey	6 mm	17 mm	3000
2005130000	ESG 6/17 MM SW	● black	6 mm	17 mm	3000
2005100000	ESG 6/17 MM WS	○ white	6 mm	17 mm	3000
2005150000	ESG 8/20 MM GE	● yellow	8 mm	20 mm	3000
2005160000	ESG 8/20 MM GR	● grey	8 mm	20 mm	3000
2005170000	ESG 8/20 MM SW	● black	8 mm	20 mm	3000
2005140000	ESG 8/20 MM WS	○ white	8 mm	20 mm	3000
2005210000	ESG 9/17 MM GE	● yellow	9 mm	17 mm	3000
2005230000	ESG 9/17 MM GR	● grey	9 mm	17 mm	3000
2005250000	ESG 9/17 MM SW	● black	9 mm	17 mm	3000
2005190000	ESG 9/17 MM WS	○ white	9 mm	17 mm	3000

Raised device markers - ESG-FO

Technical data

Material	Temperature range	Fire class acc. to UL 94	Adhesive	Order No.	Type
Polyester	-30...80 °C	V-0	PE-foam with acrylic adhesive	<b>2005080000</b>	RIBBON MM 76/360 SW

Ordering data

Order No.	Type	Colour	Height	Width	Qty.
2620990000	ESG-FO 6/15 MM GE	● yellow	6 mm	15 mm	1000
2621060000	ESG-FO 6/15 MM SI	● silver	6 mm	15 mm	1000
2620980000	ESG-FO 6/15 MM WS	○ white	6 mm	15 mm	1000
2620000000	ESG-FO 6/17 MM GE	● yellow	6 mm	17 mm	1000
2620910000	ESG-FO 6/17 MM SI	● silver	6 mm	17 mm	1000
2619990000	ESG-FO 6/17 MM WS	○ white	6 mm	17 mm	1000
2620960000	ESG-FO 8/20 MM GE	● yellow	8 mm	20 mm	1000
2620970000	ESG-FO 8/20 MM SI	● silver	8 mm	20 mm	1000
2620950000	ESG-FO 8/20 MM WS	○ white	8 mm	20 mm	1000
2620920000	ESG-FO 9/17 MM GE	● yellow	9 mm	17 mm	1000
2620940000	ESG-FO 9/17 MM SI	● silver	9 mm	17 mm	1000
2620930000	ESG-FO 9/17 MM WS	○ white	9 mm	17 mm	1000



Device markers SM

Technical data

Material	Temperature range	Fire class acc. to UL 94	Adhesive	Order No.	Type
Polyester	-40...120 °C	V-0	Acrylate adhesive	<b>2005080000</b>	RIBBON MM 76/360 SW
				<b>2005040000</b>	RIBBON MM 84/300 WS

Ordering data

Order No.	Type	Colour	Height	Width	Qty.
2006240000	SM 18/9.5 MM GE	● yellow	9 mm	18 mm	1000
2006260000	SM 18/9.5 MM GR	● grey	9 mm	18 mm	1000
2006200000	SM 18/9.5 MM SW	● black	9 mm	18 mm	1000
2006220000	SM 18/9.5 MM WS	○ white	9 mm	18 mm	1000
2535620000	SM 22/22 MM GE	● yellow	22 mm	22 mm	1000
2535630000	SM 22/22 MM GR	● grey	22 mm	22 mm	1000
2535610000	SM 22/22 MM WS	○ white	22 mm	22 mm	1000
2006420000	SM 27/8 MM GE	● yellow	8 mm	27 mm	1000
2006490000	SM 27/8 MM GN	● green	8 mm	27 mm	1000
2006480000	SM 27/8 MM GR	● grey	8 mm	27 mm	1000
2006460000	SM 27/8 MM RT	● red	8 mm	27 mm	1000
2006440000	SM 27/8 MM SW	● black	8 mm	27 mm	1000
2006400000	SM 27/8 MM WS	○ white	8 mm	27 mm	1000
2006510000	SM 27/12.5 MM GE	● yellow	12.5 mm	27 mm	1000
2006500000	SM 27/12.5 MM GN	● green	12.5 mm	27 mm	1000
2006520000	SM 27/12.5 MM GR	● grey	12.5 mm	27 mm	1000
2006540000	SM 27/12.5 MM RT	● red	12.5 mm	27 mm	1000
2006530000	SM 27/12.5 MM SW	● black	12.5 mm	27 mm	1000
2006500000	SM 27/12.5 MM WS	○ white	12.5 mm	27 mm	1000
2006300000	SM 27/18 MM GE	● yellow	18 mm	27 mm	1000
2006380000	SM 27/18 MM GN	● green	18 mm	27 mm	1000
2006340000	SM 27/18 MM GR	● grey	18 mm	27 mm	1000
2006360000	SM 27/18 MM RT	● red	18 mm	27 mm	1000
2006320000	SM 27/18 MM SW	● black	18 mm	27 mm	1000
2006280000	SM 27/18 MM WS	○ white	18 mm	27 mm	1000



Raised device markers - SM-FO

Technical data

Material	Temperature range	Fire class acc. to UL 94	Adhesive	Order No.	Type
Polyester	-30...80 °C	V-0	PE-foam with acrylic adhesive	<b>2005080000</b>	RIBBON MM 76/360 SW

Ordering data

Order No.	Type	Colour	Height	Width	Qty.
2621170000	SM-FO 18/9.5 MM SI	● silver	9 mm	18 mm	500
2621160000	SM-FO 18/9.5 MM WS	○ white	9 mm	18 mm	500
2712080000	SM-FO 22/22 MM GE	● yellow	22 mm	22 mm	500
2712070000	SM-FO 22/22 MM SI	● silver	22 mm	22 mm	500
2712060000	SM-FO 22/22 MM WS	○ white	22 mm	22 mm	500
2621230000	SM-FO 27/12.5 MM GE	● yellow	12.5 mm	27 mm	500
2621240000	SM-FO 27/12.5 MM SI	● silver	12.5 mm	27 mm	500
2621220000	SM-FO 27/12.5 MM WS	○ white	12.5 mm	27 mm	500
2621110000	SM-FO 27/18 MM GE	● yellow	18 mm	27 mm	500
2621120000	SM-FO 27/18 MM SI	● silver	18 mm	27 mm	500
2621100000	SM-FO 27/18 MM WS	○ white	18 mm	27 mm	500
2621080000	SM-FO 27/8 MM GE	● yellow	8 mm	27 mm	500
2621090000	SM-FO 27/8 MM SI	● silver	8 mm	27 mm	500
2621070000	SM-FO 27/8 MM WS	○ white	8 mm	27 mm	500



Device markers SM

Technical data

Material	Temperature range	Fire class acc. to UL 94	Adhesive	Order No.	Type
Polyester	-40...120 °C	V-0	Acrylate adhesive	<b>2005080000</b>	RIBBON MM 76/360 SW
				<b>2005040000</b>	RIBBON MM 84/300 WS

Ordering data

Order No.	Type	Colour	Height	Width	Qty.
<b>2005810000</b>	SM 27/18-22 MM GE	● yellow	47.75 mm	27 mm	1000
<b>2005920000</b>	SM 27/18-22 MM GN	● green	47.75 mm	27 mm	1000
<b>2005860000</b>	SM 27/18-22 MM GR	● grey	47.75 mm	27 mm	1000
<b>2005900000</b>	SM 27/18-22 MM RT	● red	47.75 mm	27 mm	1000
<b>2005880000</b>	SM 27/18-22 MM SW	● black	47.75 mm	27 mm	1000
<b>2005840000</b>	SM 27/18-22 MM WS	○ white	47.75 mm	27 mm	1000
<b>2006080000</b>	SM 36/18-30 MM GE	● yellow	56 mm	36 mm	1000
<b>2006180000</b>	SM 36/18-30 MM GN	● green	56 mm	36 mm	1000
<b>2006120000</b>	SM 36/18-30 MM GR	● grey	56 mm	36 mm	1000
<b>2006160000</b>	SM 36/18-30 MM RT	● red	56 mm	36 mm	1000
<b>2006140000</b>	SM 36/18-30 MM SW	● black	56 mm	36 mm	1000
<b>2006100000</b>	SM 36/18-30 MM WS	○ white	56 mm	36 mm	1000

Raised device markers - SM-FO

Technical data

Material	Temperature range	Fire class acc. to UL 94	Adhesive	Order No.	Type
Polyester	-30...80 °C	V-0	PE-foam with acrylic adhesive	<b>2005080000</b>	RIBBON MM 76/360 SW

Ordering data

Order No.	Type	Colour	Height	Width	Qty.
<b>2621140000</b>	SM-FO 27/18-22 MM GE	● yellow	47.75 mm	27 mm	500
<b>2621130000</b>	SM-FO 27/18-22 MM SI	● silver	47.75 mm	27 mm	500
<b>2621150000</b>	SM-FO 27/18-22 MM WS	○ white	47.75 mm	27 mm	500
<b>2621200000</b>	SM-FO 36/18-30 MM GE	● yellow	56 mm	36 mm	100
<b>2621210000</b>	SM-FO 36/18-30 MM SI	● silver	56 mm	36 mm	100
<b>2621190000</b>	SM-FO 36/18-30 MM WS	○ white	56 mm	36 mm	100

Device markers SM DIA

Technical data

Material	Temperature range	Fire class acc. to UL 94	Adhesive	Order No.	Type
Polyester	-40...120 °C	V-0	Acrylate adhesive	<b>2005080000</b>	RIBBON MM 76/360 SW

Ordering data

Order No.	Type	Colour	Diameter	Qty.
<b>2006060000</b>	SM DIA 60-22 MM GE	● yellow	60 mm	450

Raised device markers - SM-FO DIA

Technical data

Material	Temperature range	Fire class acc. to UL 94	Adhesive	Order No.	Type
Polyester	-30...80 °C	V-0	PE-foam with acrylic adhesive	<b>2005080000</b>	RIBBON MM 76/360 SW

Ordering data

Order No.	Type	Colour	Diameter	Qty.
<b>2621180000</b>	SM-FO DIA 60-22 MM GE	● yellow	60 mm	100

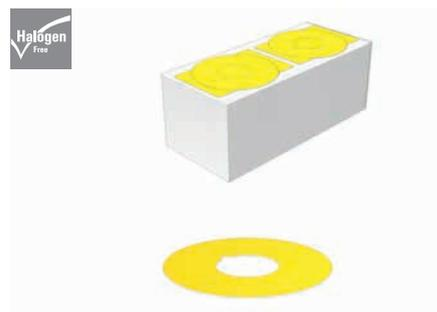
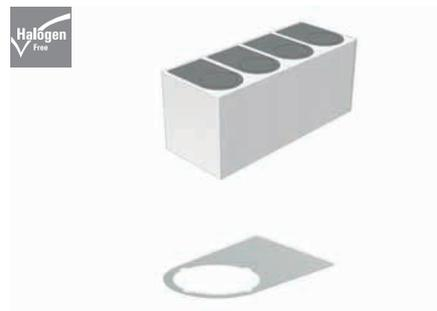

### Device markers CC

#### Technical data

Material	Temperature range	Fire class acc. to UL 94	Adhesive	Order No.	Type
Polyester	-40...120 °C	V-0	Acrylate adhesive	<b>2005080000</b>	RIBBON MM 76/360 SW
				<b>2005040000</b>	RIBBON MM 84/300 WS

#### Ordering data

Order No.	Type	Colour	Height	Width	Qty.
2005630000	CC 15/27 MM GE	● yellow	15 mm	27 mm	450
2005660000	CC 15/27 MM GR	● grey	15 mm	27 mm	450
2005690000	CC 15/27 MM SW	● black	15 mm	27 mm	450
2005600000	CC 15/27 MM WS	○ white	15 mm	27 mm	450
2005520000	CC 15/45 MM GE	● yellow	15 mm	45 mm	450
2005540000	CC 15/45 MM GR	● grey	15 mm	45 mm	450
2005570000	CC 15/45 MM SW	● black	15 mm	45 mm	450
2005500000	CC 15/45 MM WS	○ white	15 mm	45 mm	450
2005430000	CC 15/60 MM GE	● yellow	15 mm	60 mm	450
2005460000	CC 15/60 MM GR	● grey	15 mm	60 mm	450
2005480000	CC 15/60 MM SW	● black	15 mm	60 mm	450
2005410000	CC 15/60 MM WS	○ white	15 mm	60 mm	450
2005350000	CC 30/60 MM GE	● yellow	30 mm	60 mm	450
2005370000	CC 30/60 MM GR	● grey	30 mm	60 mm	450
2005390000	CC 30/60 MM SW	● black	30 mm	60 mm	450
2005330000	CC 30/60 MM WS	○ white	30 mm	60 mm	450
2005280000	CC 85/54 MM GE	● yellow	54 mm	85 mm	450
2005290000	CC 85/54 MM GR	● grey	54 mm	85 mm	450
2005310000	CC 85/54 MM SW	● black	54 mm	85 mm	450
2005270000	CC 85/54 MM WS	○ white	54 mm	85 mm	450



### Raised device markers - CC-FO

#### Technical data

Material	Temperature range	Fire class acc. to UL 94	Adhesive	Order No.	Type
Polyester	-30...80 °C	V-0	PE-foam with acrylic adhesive	<b>2005080000</b>	RIBBON MM 76/360 SW

#### Ordering data

Order No.	Type	Colour	Height	Width	Qty.
2621380000	CC-FO 15/27 MM GE	● yellow	15 mm	27 mm	500
2621390000	CC-FO 15/27 MM SI	● grey	15 mm	27 mm	500
2621370000	CC-FO 15/27 MM WS	○ white	15 mm	27 mm	500
2621350000	CC-FO 15/45 MM GE	● yellow	15 mm	45 mm	500
2621360000	CC-FO 15/45 MM SI	● silver	15 mm	45 mm	500
2621340000	CC-FO 15/45 MM WS	○ white	15 mm	45 mm	500
2621320000	CC-FO 15/60 MM GE	● yellow	15 mm	60 mm	500
2621330000	CC-FO 15/60 MM SI	● silver	15 mm	60 mm	500
2621310000	CC-FO 15/60 MM WS	○ white	15 mm	60 mm	500
2621290000	CC-FO 30/60 MM GE	● yellow	30 mm	60 mm	100
2621300000	CC-FO 30/60 MM SI	● silver	30 mm	60 mm	100
2621280000	CC-FO 30/60 MM WS	○ white	30 mm	60 mm	100
2621260000	CC-FO 85/54 MM GE	● yellow	54 mm	85 mm	100
2621270000	CC-FO 85/54 MM SI	● silver	54 mm	85 mm	100
2621250000	CC-FO 85/54 MM WS	○ white	54 mm	85 mm	100



Continuous device marker strips

Technical data

Material	Temperature range	Fire class acc. to UL 94	Adhesive	Order No.	Type
Polyester	-40...150 °C	V-0	Acrylate adhesive	2005080000	RIBBON MM 76/360 SW
				2005040000	RIBBON MM 84/300 WS
				2005070000	RIBBON MM 110/360 SW



Ordering data

Order No.	Type	Colour	Height	Length	Qty.
2621400000	EL 6 MM WS 30M	○ white	6 mm	30000 mm	1
2621410000	EL 6 MM GE 30M	● yellow	6 mm	30000 mm	1
2621420000	EL 9 MM WS 30M	○ white	9 mm	30000 mm	1
2621430000	EL 9 MM GE 30M	● yellow	9 mm	30000 mm	1
2518680000	EL 12 MM BL 30M	● blue	12 mm	30000 mm	1
2528220000	EL 12 MM RT 30M	● red	12 mm	30000 mm	1
2528320000	EL 12 MM GN 30M	● green	12 mm	30000 mm	1
2006580000	EL 12 MM GE 30M	● yellow	12 mm	30000 mm	1
2006570000	EL 12 MM WS 30M	○ white	12 mm	30000 mm	1
2528380000	EL 12 MM SW 30M	● black	12 mm	30000 mm	1
2006560000	EL 12 MM SI 30M	● silver	12 mm	30000 mm	1
2518990000	EL 15 MM BL 30M	● blue	15 mm	30000 mm	1
2528270000	EL 15 MM RT 30M	● red	15 mm	30000 mm	1
2528330000	EL 15 MM GN 30M	● green	15 mm	30000 mm	1
2006600000	EL 15 MM GE 30M	● yellow	15 mm	30000 mm	1
2006590000	EL 15 MM WS 30M	○ white	15 mm	30000 mm	1
2528390000	EL 15 MM SW 30M	● black	15 mm	30000 mm	1
2006610000	EL 15 MM SI 30M	● silver	15 mm	30000 mm	1
2519000000	EL 27 MM BL 30M	● blue	27 mm	30000 mm	1
2528280000	EL 27 MM RT 30M	● red	27 mm	30000 mm	1
2528340000	EL 27 MM GN 30M	● green	27 mm	30000 mm	1
2006640000	EL 27 MM GE 30M	● yellow	27 mm	30000 mm	1
2006630000	EL 27 MM WS 30M	○ white	27 mm	30000 mm	1
2528400000	EL 27 MM SW 30M	● black	27 mm	30000 mm	1
2006620000	EL 27 MM SI 30M	● silver	27 mm	30000 mm	1
2519010000	EL 38 MM BL 30M	● blue	38 mm	30000 mm	1
2528290000	EL 38 MM RT 30M	● red	38 mm	30000 mm	1
2528350000	EL 38 MM GN 30M	● green	38 mm	30000 mm	1
2006670000	EL 38 MM GE 30M	● yellow	38 mm	30000 mm	1
2006660000	EL 38 MM WS 30M	○ white	38 mm	30000 mm	1
2528410000	EL 38 MM SW 30M	● black	38 mm	30000 mm	1
2006650000	EL 38 MM SI 30M	● silver	38 mm	30000 mm	1
2519020000	EL 60 MM BL 30M	● blue	60 mm	30000 mm	1
2528300000	EL 60 MM RT 30M	● red	60 mm	30000 mm	1
2528360000	EL 60 MM GN 30M	● green	60 mm	30000 mm	1
2006700000	EL 60 MM GE 30M	● yellow	60 mm	30000 mm	1
2006690000	EL 60 MM WS 30M	○ white	60 mm	30000 mm	1
2528420000	EL 60 MM SW 30M	● black	60 mm	30000 mm	1
2006680000	EL 60 MM SI 30M	● silver	60 mm	30000 mm	1
2519030000	EL 100 MM BL 30M	● blue	100 mm	30000 mm	1
2528310000	EL 100 MM RT 30M	● red	100 mm	30000 mm	1
2528370000	EL 100 MM GN 30M	● green	100 mm	30000 mm	1
2006730000	EL 100 MM GE 30M	● yellow	100 mm	30000 mm	1
2006720000	EL 100 MM WS 30M	○ white	100 mm	30000 mm	1
2528430000	EL 100 MM SW 30M	● black	100 mm	30000 mm	1
2006710000	EL 100 MM SI 30M	● silver	100 mm	30000 mm	1

CC-Rail - non-adhesive labels

Technical data

Material	Temperature range	Fire class acc. to UL 94	Adhesive	Order No.	Type
Polypropylene	-50...100 °C	HB		2005080000	RIBBON MM 76/360 SW

Ordering data

Order No.	Type	Colour	Height	Length	Qty.
2619980000	EL CC-RAIL MM GE 30M	● yellow	15 mm	30000 mm	1
2619970000	EL CC-RAIL MM WS 30M	○ white	15 mm	30000 mm	1



# Labels

## The right format for all equipment

THM labels offer brilliant printing quality thanks to the thermal transfer technology. Different materials and the user-friendly printing system M-Print® PRO under Windows optimise all labelling needs.

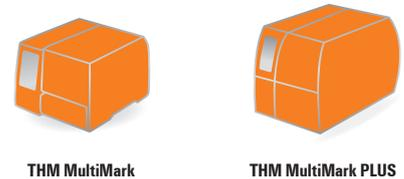

THM MultiMark

THM MultiMark PLUS

### THM MT 30X

Our powerful self-adhesive labels for equipment identification and the use of different materials for your application means that superior standards of labelling are achieved.



### THM GEW

Woven-fabric labels are made from a very flexible cotton fabric. The high adhesion values enable flexible application, especially on rough surfaces.

### THM ET S7

THM ET S7 are non-adhesive, roll packaged labels and are used to label the SIMATIC 200SP, S7-1500, S7-300 and S7-400 modules from Siemens.

Weidmüller's wide range of labels offers the right solution for every application

### THM EL

THM EL are adhesive-backed continuous labels for the marking of cable conduits and distribution boxes.

#### Ordering data device markers

Possible printing systems	THM MultiMark, THM MultiMark PLUS
Ink ribbon	2005070000 RIBBON MM 110/360 SW (black)
	2005080000 RIBBON MM 76/360 SW (black)
	2005040000 RIBBON MM 80/300 WS (white)
Pressure roller	Labels, shrink sleeves: THM MMP ROLLER 115 (1357420000)

### KSW

KSW marking strips are used to identify multi-pole PCB connectors. Users can print them individually without being confined to a certain pitch.

#### Technical data THM MT 30X and THM EL

Material	Polyester or vinyl
Material thickness	0.05 mm
Reverse side	Aluminised only with silver
Adhesive	strong acrylic adhesive
Initial adhesion	540 gr./cm <sup>2</sup>

#### Your benefits with THM labels

- High-quality polyester labels in different colours
- Due to the flexible material and thick adhesive layer, the THM GEW can be used on angled or round objects such as cables or hoses
- Roll-packaged THM ET S7 can be used to label the Simatic 200S, S7-300 and S7-400 modules from Siemens
- Labels are automatically positioned in the printer for a perfectly centred print on each label

THM MT - polyester label

Technical data

Material	Temperature range	Fire class acc. to UL 94	Adhesive	Order No.	Type
Polyester	-40...150 °C	V-0	Acrylate	2005070000	RIBBON MM 110/360 SW

Ordering data

Order No.	Type	Colour	Height	Width	Qty.
1310540000	THM MT30X 8/8 GE	● yellow	8 mm	8 mm	10000
1954070000	THM MT30X 8/8 WS	○ white	8 mm	8 mm	10000
1391390000	THM MT30X 12/6 GE	● yellow	6 mm	12 mm	10000
1072690000	THM MT30X 15/4 GE	● yellow	4 mm	15 mm	10000
1964130000	THM MT30X 15/5.1 GE	● yellow	5.08 mm	15 mm	10000
1753231687	THM MT30X 15/6 GE	● yellow	6 mm	15 mm	10000
1753230001	THM MT30X 15/6 SI	● silver	6 mm	15 mm	10000
1753231044	THM MT30X 15/6 WS	○ white	6 mm	15 mm	10000
1058740000	THM MT30X 15/9 GE	● yellow	9 mm	15 mm	10000
1058750000	THM MT30X 15/9 WS	○ white	9 mm	15 mm	10000
1516990000	THM MT30X 16.5/5.1 GE	● yellow	5.1 mm	16.5 mm	10000
1852520000	THM MT30X 16/7 GE	● yellow	7 mm	16 mm	12500
1338280000	THM MT30X 17.5/17.5 SI	● silver	17.5 mm	17.5 mm	5000
1027620000	THM MT30X 17/8 GE	● yellow	8 mm	17 mm	10000
2712050000	THM MT30X 17/8 WS	○ white	8 mm	17 mm	10000
1856650000	THM MT30X 17/9 GE	● yellow	9 mm	17 mm	10000
1356500000	THM MT30X 17/9 SI	● silver	9 mm	17 mm	10000
1968130000	THM MT30X 17/9 WS	○ white	9 mm	17 mm	10000
1753271687	THM MT30X 18/6 GE	● yellow	6 mm	18 mm	10000
1753270001	THM MT30X 18/6 SI	● silver	6 mm	18 mm	10000
1753271044	THM MT30X 18/6 WS	○ white	6 mm	18 mm	10000
2713810000	THM MT30X 18/6.5 SI	● silver	6.5 mm	18 mm	10000
1753251687	THM MT30X 18/9 GE	● yellow	9 mm	18 mm	10000
1753250001	THM MT30X 18/9 SI	● silver	9 mm	18 mm	10000
1753251044	THM MT30X 18/9 WS	○ white	9 mm	18 mm	10000
1085440000	THM MT30X 20/100 WS	○ white	100 mm	20 mm	1500
1753241687	THM MT30X 20/8 GE	● yellow	8 mm	20 mm	10000
1753241044	THM MT30X 20/8 WS	○ white	8 mm	20 mm	10000
1317010000	THM MT30X 24/157 SI	● silver	157 mm	24 mm	500
1378120000	THM MT30X 25.4/50.8 SI	● silver	50.8 mm	25.4 mm	2000
1891770000	THM MT30X 25.9/7.1 WS	○ white	7.1 mm	25.9 mm	5000
1751751687	THM MT30X 25/12 GE	● yellow	12 mm	25 mm	10000
1751750001	THM MT30X 25/12 SI	● silver	12 mm	25 mm	10000
1751751044	THM MT30X 25/12 WS	○ white	12 mm	25 mm	10000
1770090000	THM MT30X 26.5/17.5 SI	● silver	17.5 mm	26.5 mm	10000
1751761687	THM MT30X 26/10 GE	● yellow	10 mm	26 mm	10000
1751760001	THM MT30X 26/10 SI	● silver	10 mm	26 mm	10000
1751761044	THM MT30X 26/10 WS	○ white	10 mm	26 mm	10000
1477340000	THM MT30X 27/27 SI	● silver	27 mm	27 mm	5000
1449830000	THM MT30X 27/85 WS	○ white	85 mm	27 mm	1000
1753261687	THM MT30X 30/20 GE	● yellow	20 mm	30 mm	6000
1753260001	THM MT30X 30/20 SI	● silver	20 mm	30 mm	6000
1753261044	THM MT30X 30/20 WS	○ white	20 mm	30 mm	6000
1014680000	THM MT30X 30/52 SI	● silver	52 mm	30 mm	2000
1356490000	THM MT30X 32/9 GE	● yellow	9 mm	32 mm	10000
1751770001	THM MT30X 32/9 SI	● silver	9 mm	32 mm	10000
1751771044	THM MT30X 32/9 WS	○ white	9 mm	32 mm	10000
1180910000	THM MT30X 36/89 WS	○ white	89 mm	36 mm	1000
1862350000	THM MT30X 38.1/31.8 SI	● silver	31.75 mm	38.1 mm	1000
1011610000	THM MT30X 38/17 WS	○ white	17 mm	38 mm	4000
1751801687	THM MT30X 38/19 GE	● yellow	19 mm	38 mm	2000
1751800001	THM MT30X 38/19 SI	● silver	19 mm	38 mm	2000
1751801044	THM MT30X 38/19 WS	○ white	19 mm	38 mm	2000
1751811687	THM MT30X 45/23 GE	● yellow	23 mm	45 mm	2000
1751810001	THM MT30X 45/23 SI	● silver	23 mm	45 mm	2000
1751811044	THM MT30X 45/23 WS	○ white	23 mm	45 mm	2000
1852540000	THM MT30X 57/27 SI	● silver	27 mm	57 mm	1000
2621550000	THM MT30X 50/18 WS	○ white	18 mm	50 mm	2000



**THM MT - polyester label**

**Technical data**

Material	Temperature range	Fire class acc. to UL 94	Adhesive	Order No.	Type
Polyester	-40...150 °C	V-0	Acrylate adhesive	<b>2005070000</b>	RIBBON MM 110/360 SW

**Ordering data**

Order No.	Type	Colour	Height	Width	Qty.
1378110000	THM MT30X 63.5/50.8 SI	● silver	50.8 mm	63.5 mm	500
1751831687	THM MT30X 65/35 GE	● yellow	35 mm	65 mm	1000
1538740000	THM MT30X 65/35 RT	● red	35 mm	64 mm	1000
1751830001	THM MT30X 65/35 SI	● silver	35 mm	65 mm	1000
1751830004	THM MT30X 65/35 SI/G	● silver	35 mm	65 mm	1000
1751831044	THM MT30X 65/35 WS	○ white	35 mm	65 mm	1000
1378130000	THM MT30X 76.2/50.8 WS	○ white	50.8 mm	76.5 mm	500
1498790000	THM MT30X 76/25 WS	○ white	25 mm	76 mm	1000
1003410000	THM MT30X 89/60 SI	● silver	60 mm	89 mm	1000
1498780000	THM MT30X 89/60 WS	○ white	60 mm	89 mm	1000
1058770000	THM MT30X 100/90 SI	● silver	90 mm	100 mm	500
1751821687	THM MT30X 101/48 GE	● yellow	48 mm	101 mm	500
1751820001	THM MT30X 101/48 SI	● silver	48 mm	101 mm	500
1751821044	THM MT30X 101/48 WS	○ white	48 mm	101 mm	500
1061810000	THM MT30X 101/74 GE	● yellow	74 mm	101 mm	500
1466270000	THM MT30X 101/74 RT	● red	74 mm	101 mm	500
1762960001	THM MT30X 101/74 SI	● silver	74 mm	101 mm	500
2455620000	THM MT30X 101/74 WS	○ white	74 mm	101 mm	500
1192740000	THM MT30X 101/48 GE/G	● yellow	48 mm	101 mm	500
1778170000	THM MT30X 101/150 SI/G	● silver	150 mm	101 mm	250
2712040000	THM MT30X DIA 30 GE	● yellow			1000



**THM VIN - vinyl label**

**Technical data**

Material	Temperature range	Fire class acc. to UL 94	Adhesive	Order No.	Type
Vinyl film	-50...90 °C	V-0	Polyacrylate adhesive	<b>2005070000</b>	RIBBON MM 110/360 SW

**Ordering data**

Order No.	Type	Colour	Height	Width	Qty.
1209010000	THM VIN 36/18 SI	● silver	18 mm	36 mm	2500
1192750000	THM VIN 101/74 GE/G	● yellow	74 mm	101 mm	500
1192760000	THM VIN 101/150 GE/G	● yellow	150 mm	101 mm	250





**THM GEW - textile label**

**Technical data**

Material	Temperature range	Fire class acc. to UL 94	Adhesive	Order No.	Type
Cotton fabric	-29...80 °C	V-0	Natural rubber adhesive	2005070000	RIBBON MM 110/360 SW

**Ordering data**

Order No.	Type	Colour	Height	Width	Qty.
1059790000	THM GEW 15/6 GE	● yellow	6 mm	15 mm	10000
1059780000	THM GEW 15/6 WS	○ white	6 mm	15 mm	10000
1365630000	THM GEW 15/9 GE	● yellow	9 mm	15 mm	10000
1059810000	THM GEW 17/9 GE	● yellow	9 mm	17 mm	10000
1059800000	THM GEW 17/9 WS	○ white	9 mm	17 mm	10000
1059830000	THM GEW 18/6 GE	● yellow	6 mm	18 mm	10000
1059820000	THM GEW 18/6 WS	○ white	6 mm	18 mm	10000
1059850000	THM GEW 18/9 GE	● yellow	9 mm	18 mm	10000
1059840000	THM GEW 18/9 WS	○ white	9 mm	18 mm	10000
1059880000	THM GEW 20/8 GE	● yellow	8 mm	20 mm	10000
1059870000	THM GEW 20/8 WS	○ white	8 mm	20 mm	10000
2712030000	THM GEW 20/10 GE	● yellow	10 mm	20 mm	5000
2712020000	THM GEW 20/10 WS	○ white	10 mm	20 mm	5000
1391380000	THM GEW 20/12 GE	● yellow	12 mm	20 mm	2000
1114450000	THM GEW 30/8 GE	● yellow	8 mm	30 mm	10000
1335100000	THM GEW 38/19 GE	● yellow	19 mm	38 mm	2000
1368740000	THM GEW 45/23 GE	● yellow	23 mm	45 mm	2000



**THM EL - Endless polyester**

**Technical data**

Material	Temperature range	Fire class acc. to UL 94	Adhesive	Order No.	Type
Polyester	-40...150 °C	V-0	Acrylate adhesive	2005070000	RIBBON MM 110/360 SW

**Ordering data**

Order No.	Type	Colour	Height	Length	Qty.
1356520000	THM EL 24 SI 3L 30M	● silver	24 mm	30000 mm	1
1517190000	THM EL 30 GE 30M	● yellow	30 mm	30000 mm	1
1517200000	THM EL 30 SI 30M	● silver	30 mm	30000 mm	1
1517180000	THM EL 30 WS 30M	○ white	30 mm	30000 mm	1
1517230000	THM EL 50 GE 30M	● yellow	30 mm	30000 mm	1
1517240000	THM EL 50 SI 30M	● silver	50 mm	30000 mm	1
1517220000	THM EL 50 WS 30M	○ white	50 mm	30000 mm	1
1391400000	THM EL 60 SI 50M	● silver	60 mm	50000 mm	1
1419980000	THM EL 100 GE 30M	● yellow	100 mm	30000 mm	1
1517270000	THM EL 100 SI 30M	● silver	100 mm	30000 mm	1
1420010000	THM EL 100 WS 30M	○ white	100 mm	30000 mm	1



**THM EL VIN - Endless vinyl**

**Technical data**

Material	Temperature range	Fire class acc. to UL 94	Adhesive	Order No.	Type
Vinyl film	-40...80 °C	HB	Polyacrylate adhesive	2005070000	RIBBON MM 110/360 SW

**Ordering data**

Order No.	Type	Colour	Height	Length	Qty.
1307670000	THM EL VIN 15 WS 2L 30M	○ white	15 mm	30000 mm	1
1096170000	THM EL VIN 15 WS 5L 30M	○ white	15 mm	30000 mm	1
1105550000	THM EL VIN 24 WS 3L 30M	○ white	24 mm	30000 mm	1
1463810000	THM EL VIN 25 GE 30M	● yellow	25 mm	30000 mm	1
1105560000	THM EL VIN 38 WS 30M	○ white	38 mm	30000 mm	1
1474640000	THM EL VIN 45 WS 30M	○ white	45 mm	30000 mm	1
1463820000	THM EL VIN 50 GE 30M	● yellow	50 mm	30000 mm	1
1463830000	THM EL VIN 100 GE 30M	● yellow	100 mm	30000 mm	1
2518700000	THM EL VIN 100 WS 30M	○ white	100 mm	30000 mm	1



THM ET for Siemens - non-adhesive labels

Technical data

Material	Temperature range	Fire class acc. to UL 94	Adhesive	Order No.	Type
Polypropylene	-50...100 °C	HB		2005070000	RIBBON MM 110/360 SW

Ordering data

Order No.	Type	Colour	Height	Width	Qty.
1487690000	THM ET 200SP 12.8/31 GE	● yellow	31 mm	12.8 mm	2000
1487680000	THM ET 200SP 12.8/31 TU	● Turquoise	31 mm	12.8 mm	2000
1991670000	THM ET S7 1500 GE	● yellow	108.8 mm	22.9 mm	500
1991680000	THM ET S7 1500 TU	● Turquoise	108.8 mm	22.9 mm	500
2093070000	THM ET S7 1500-13 GE	● yellow	108.8 mm	13 mm	500
2093010000	THM ET S7 1500-13 TU	● Turquoise	108.8 mm	13 mm	500
1161770000	THM ET S7 300-1 GE	● yellow	103 mm	22.6 mm	500
1161750000	THM ET S7 300-1 TU	● Turquoise	103 mm	22.6 mm	500
1161740000	THM ET S7 300-2 GE	● yellow	103.8 mm	17.3 mm	1000
1161730000	THM ET S7 300-2 TU	● Turquoise	103.8 mm	17.3 mm	1000
1161710000	THM ET S7 400 TU	● Turquoise	251 mm	13.5 mm	500
1161810000	THM ET S7 50/12.5 GE	● yellow	50 mm	12.5 mm	2000
1161790000	THM ET S7 50/12.5 TU	● Turquoise	50 mm	12.5 mm	2000
1095590000	THM ET S7 50/25 GE	● yellow	50 mm	25 mm	1250
1161780000	THM ET S7 50/25 TU	● Turquoise	50 mm	25 mm	1250

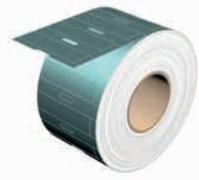

ET for Siemens - non-adhesive labels

Technical data

Material	Temperature range	Fire class acc. to UL 94	Adhesive
Vinyl film	-40 °C..80 °C	HB	



Ordering data

Order No.	Type	Colour	Height	Width	Qty.
1804480000	ET S7-12/50 GE-A4	● yellow	50 mm	12 mm	840
1865440000	ET S7-12/50-TU-A4	● Turquoise	50 mm	12 mm	840
1045500000	ET S7-200-TU-A4-1	● Turquoise	203 mm	15.5 mm	800
1045490000	ET S7-200-TU-A4-2	● Turquoise	203 mm	12 mm	800
1821020000	ET S7-300-GE-A4-1	● yellow	100 mm	22.6 mm	160
1847650000	ET S7-300-GE-A4-2	● yellow	208 mm	17.3 mm	220
1865450000	ET S7-300-TU-A4-1	● Turquoise	100 mm	22.6 mm	160
1865460000	ET S7-300-TU-A4-2	● Turquoise	208 mm	17.3 mm	220
1821040000	ET S7-400-GE-A4-1	● yellow	251 mm	11.5 mm	140
1821030000	ET S7-400-GE-A4-2	● yellow	251 mm	11.5 mm	140
1847640000	ET S7-400-GE-A4-3	● yellow	251 mm	13.5 mm	140
1865470000	ET S7-400-TU-A4-1	● Turquoise	251 mm	11.5 mm	140
1865480000	ET S7-400-TU-A4-2	● Turquoise	251 mm	11.5 mm	140
1865490000	ET S7-400-TU-A4-3	● Turquoise	251 mm	13.5 mm	140



LM MT 300

Technical data

Material	Temperature range	Fire class acc. to UL 94	Adhesive
Polyester, PVC-free	-40 °C...150 °C	HB	Acrylate adhesive



Ordering data

Order No.	Type	Colour	Height	Width	Qty.
1882910000	LM MT300 12/6 GE	● yellow	6 mm	12 mm	3220
1724141044	LM MT300 15/4.6 WS	○ white	4.63 mm	15 mm	6270
1724141687	LM MT300 15/4.6 GE	● yellow	4.63 mm	15 mm	6270
1724140001	LM MT300 15/4.6 SI	● silver	4.63 mm	15 mm	6270
1686361044	LM MT300 15/6 WS	○ white	6 mm	15.2 mm	4840
1686361687	LM MT300 15/6 GE	● yellow	6 mm	15.2 mm	4840
1686360001	LM MT300 15/6 SI	● silver	6 mm	15.2 mm	4840
1882890000	LM MT300 15/9 GE	● yellow	9 mm	15 mm	1860
1835820000	LM MT300 17/6 GE	● yellow	6 mm	17 mm	4400
1724151044	LM MT300 17/9 WS	○ white	9 mm	17.8 mm	3410
1724151687	LM MT300 17/9 GE	● yellow	9 mm	17.8 mm	3410
1724150001	LM MT300 17/9 SI	● silver	9 mm	17.8 mm	3410
1749321044	LM MT300 18/6.5 WS	○ white	6.5 mm	18 mm	3200
1749321687	LM MT300 18/6.5 GE	● yellow	6.5 mm	18 mm	3200
1749320001	LM MT300 18/6.5 SI	● silver	6.5 mm	18 mm	3200
1835830000	LM MT300 19/6.3 GE	● yellow	6.3 mm	19.05 mm	2560
1686381044	LM MT300 20/8 WS	○ white	8 mm	20.3 mm	2640
1686381687	LM MT300 20/8 GE	● yellow	8 mm	20.3 mm	2640
1686380001	LM MT300 20/8 SI	● silver	8 mm	20.3 mm	2640
1686391044	LM MT300 25.4/12.7 WS	○ white	12.7 mm	25.4 mm	1470
1686391687	LM MT300 25.4/12.7 GE	● yellow	12.7 mm	25.4 mm	1470
1686390001	LM MT300 25.4/12.7 SI	● silver	12.7 mm	25.4 mm	1470
1686401044	LM MT300 26/10 WS	○ white	10 mm	26 mm	1560
1686401687	LM MT300 26/10 GE	● yellow	10 mm	26 mm	1560
1686400001	LM MT300 26/10 SI	● silver	10 mm	26 mm	1560
1861510000	LM MT300 27/8 GE	● yellow	8 mm	27 mm	1980
1873810000	LM MT300 27/18 SI	● silver	18 mm	27 mm	900
1724161044	LM MT300 30/20 WS	○ white	20 mm	30 mm	780
1724160001	LM MT300 30/20 SI	● silver	20 mm	30 mm	780
1724161687	LM MT300 30/20 GE	● yellow	20 mm	30 mm	780
1140460000	LM MT300 35/16 WS	○ white	35 mm	16 mm	850
1760461044	LM MT300 40/6 WS	○ white	6 mm	40 mm	1760
1686421044	LM MT300 56/22 WS	○ white	22 mm	56 mm	360
1686420001	LM MT300 56/22 SI	● silver	22 mm	56 mm	360
1686421687	LM MT300 56/22 GE	● yellow	22 mm	56 mm	360
1686431044	LM MT300 60/36 WS	○ white	36 mm	60 mm	210
1686431687	LM MT300 60/36 GE	● yellow	36 mm	60 mm	210
1686430001	LM MT300 60/36 SI	● silver	36 mm	60 mm	210
1003400000	LM MT300 89/34 WS	○ white	34 mm	89 mm	160
1975160000	LM MT300 105/105 SI	● silver	105 mm	105 mm	40
1724171044	LM MT300 105/148 WS	○ white	148 mm	105 mm	40
1724170001	LM MT300 105/148 SI	● silver	148 mm	105 mm	40
1915320000	LM MT300 202/12 GE	● yellow	12 mm	202 mm	220
1724181687	LM MT300 210/148 GE	● yellow	148 mm	210 mm	20
1724180001	LM MT300 210/148 SI	● silver	148 mm	210 mm	20
1686441044	LM MT300 210/297 WS	○ white	297 mm	210 mm	10
1686441687	LM MT300 210/297 GE	● yellow	297 mm	210 mm	10
1686440001	LM MT300 210/297 SI	● silver	297 mm	210 mm	10

# Standard printed markers

DEK card – Dekafix standard printing	E.2
CableLine® – Introduction	E.4
CableLine® – CLI C – closed wire markers	E.6
CableLine® – CLI O – open wire markers	E.38
CableLine® – CLI M – cable markers and holders	E.44
CableLine® – accessories	E.51
WSM – stainless steel markers	E.54
Labels – standard print	E.58
KSW – PCB plug-in connector labels	E.60

## DEK card – Dekafix standard printing

The Dekafix marker is the universal marker for terminals and plug-in connectors, as well as electronic modules from the Weidmüller product range. Dekafix provides you with a wide range of standard printing options. The system is particularly suitable for short sequences of numbers and is also available for customer-specific printing.

- In strips for fast installation
- Large selection of ready-to-use printed markers
- Excellent printing quality with the MC Laser
- Available in 4 widths

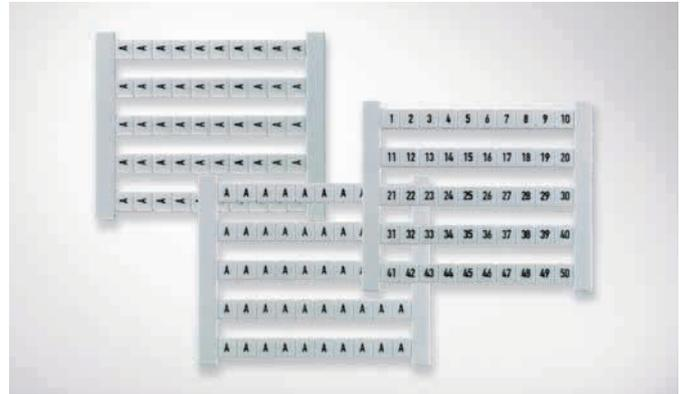

In the form of a card, the Dekafix (DEK) marker is the universal marker for the Weidmüller SAK, W, P and Z series. The markers lie flush in the marker channel which guarantees optimum and secure positioning.



- The DEK marker is suitable for all wire and plug-in connectors, plus electronic assemblies from Weidmüller
- The system is particularly suitable for short number strings and is also available with custom printing
- Wide selection of ready-to-use, printed markers
- In strips for fast installation



### Technical data

Material	Polyamide 66, halogen-free
UL 94 flammability rating	V2
Temperature range	-40 °C to 100 °C
Printing	Black

### Ordering data

Qty	500 pcs	10 cards
Pitch	DEK 5 = 5 mm ; DEK 6 = 6 mm ; DEK 6.5 = 6.5 mm ; DEK 8 = 8 mm	
Printing variations	FW = consecutive horizontal	e.g. DEK 5 FW 1-50
	FS = consecutive vertical	e.g. DEK 5 FS 51-100
	FWZ = consecutive horizontal line	e.g. DEK 5 FWZ 1-10
	FSZ = consecutive vertical line	e.g. DEK 5 FSZ 21-30
	GW = identical horizontal	e.g. DEK 5 GW A
	GS = identical vertical	e.g. DEK 5 GS B

Specify colour and characters for special printing

## DEK variant

Type	Order No.
DEK 5 FS 1-50	0473560001
DEK 5 FS 101-150	0473560101
DEK 5 FS 151-200	0473560151
DEK 5 FS 201-250	0473560201
DEK 5 FS 51-100	0473560051
DEK 5 FSZ 1-10	0460660001
DEK 5 FSZ 11-20	0460660011
DEK 5 FSZ 21-30	0460660021
DEK 5 FSZ 31-40	0460660031
DEK 5 FSZ 41-50	0460660041
DEK 5 FSZ 51-60	0460660051
DEK 5 FSZ 61-70	0460660061
DEK 5 FSZ 71-80	0460660071
DEK 5 FSZ 81-90	0460660081
DEK 5 FSZ 91-100	0460660091
DEK 5 FW 1,3,5,...99	1358460000
DEK 5 FW 1-50	0473460001
DEK 5 FW 101-150	0473460101
DEK 5 FW 151-200	0473460151
DEK 5 FW 2,4,...100	1358560000
DEK 5 FW 201-250	0473460201
DEK 5 FW 251-300	0473460251
DEK 5 FW 301-350	0473460301
DEK 5 FW 351-400	0473460351
DEK 5 FW 401-450	0473460401
DEK 5 FW 451-500	0473460451
DEK 5 FW 501-550	0473460501
DEK 5 FW 51-100	0473460051
DEK 5 FW 551-600	0473460551
DEK 5 FW 601-650	0473460601
DEK 5 FW 651-700	0473460651
DEK 5 FW 701-750	0473460701
DEK 5 FW 751-800	0473460751
DEK 5 FW 801-850	0473460801
DEK 5 FW 851-900	0473460851
DEK 5 FW 901-950	0473460901
DEK 5 FWZ 1,3,5-19	0235860000
DEK 5 FWZ 1-10	0523060001
DEK 5 FWZ 11-20	0523060011
DEK 5 FWZ 2,4,6-20	0236160000
DEK 5 FWZ 21,23,25-39	0235960000
DEK 5 FWZ 21-30	0523060021
DEK 5 FWZ 22,24,26-40	0236260000
DEK 5 FWZ 31-40	0523060031
DEK 5 FWZ 41,43,45-59	0236060000
DEK 5 FWZ 41-50	0523060041
DEK 5 FWZ 42,44,46-60	0236360000
DEK 5 FWZ 51-60	0523060051
DEK 5 FWZ 61-70	0523060061
DEK 5 FWZ 71-80	0523060071
DEK 5 FWZ 81-90	0523060081
DEK 5 FWZ 91-100	0523060091
DEK 5 FWZ L1-EIK	0354361203
DEK 5 FWZ L1-PE	0354361187
DEK 5 FWZ U,V,W,N,PE	0558360000
DEK 5 GW +	0576261198
DEK 5 GW -	0576261199
DEK 5 GW 1	0522660001
DEK 5 GW 10	0522660010
DEK 5 GW 11	0522660011
DEK 5 GW 12	0522660012
DEK 5 GW 13	0522660013
DEK 5 GW 14	0522660014
DEK 5 GW 15	0522660015
DEK 5 GW 16	0522660016
DEK 5 GW 17	0522660017
DEK 5 GW 18	0522660018
DEK 5 GW 19	0522660019
DEK 5 GW 2	0522660002
DEK 5 GW 20	0522660020
DEK 5 GW 21	0522660021
DEK 5 GW 3	0522660003

Type	Order No.
DEK 5 GW 4	0522660004
DEK 5 GW 5	0522660005
DEK 5 GW 6	0522660006
DEK 5 GW 7	0522660007
DEK 5 GW 8	0522660008
DEK 5 GW 9	0522660009
DEK 5 GW A	0522761021
DEK 5 GW B	0522761022
DEK 5 GW ERDE	0576261202
DEK 5 GW ERDE I.KR.	0576261203
DEK 5 GW F	0522761026
DEK 5 GW L	0522761032
DEK 5 GW L1	0522361075
DEK 5 GW L2	0522361076
DEK 5 GW L3	0522361077
DEK 5 GW N	0522761034
DEK 5 GW O	0522761035
DEK 5 GW PE	0537261187
DEK 5 GW R	0522761038
DEK 5 GW S	0522761039
DEK 5 GW T	0522761040
DEK 5 GW U	0522761041
DEK 5 GW V	0522761042
DEK 5 GW W	0522761043
DEK 5 GW X	0522761044
DEK 5/3,5 MC FSZ 1-10	1762320001
DEK 5/3,5 MC FSZ 101-110	1762320101
DEK 5/3,5 MC FSZ 11-20	1762320011
DEK 5/3,5 MC FSZ 111-120	1762320111
DEK 5/3,5 MC FSZ 121-130	1762320121
DEK 5/3,5 MC FSZ 21-30	1762320021
DEK 5/3,5 MC FSZ 31-40	1762320031
DEK 5/3,5 MC FSZ 41-50	1762320041
DEK 5/3,5 MC FSZ 51-60	1762320051
DEK 5/3,5 MC FSZ 61-70	1762320061
DEK 5/3,5 MC FSZ 71-80	1762320071
DEK 5/3,5 MC FSZ 81-90	1762320081
DEK 5/3,5 MC FSZ 91-100	1762320091
DEK 6 FS 1-50	0468760001
DEK 6 FS 101-150	0468760101
DEK 6 FS 51-100	0468760051
DEK 6 FSZ 1-10	0133360001
DEK 6 FSZ 11-20	0133360011
DEK 6 FSZ 21-30	0133360021
DEK 6 FSZ 31-40	0133360031
DEK 6 FSZ 41-50	0133360041
DEK 6 FW 1,3,5,...99	1358660000
DEK 6 FW 1-50	0468660001
DEK 6 FW 101-150	0468660101
DEK 6 FW 151-200	0468660151
DEK 6 FW 2,4,...100	1358760000
DEK 6 FW 201-250	0468660201
DEK 6 FW 251-300	0468660251
DEK 6 FW 301-350	0468660301
DEK 6 FW 351-400	0468660351
DEK 6 FW 451-500	0468660451
DEK 6 FW 501-550	0468660501
DEK 6 FW 51-100	0468660051
DEK 6 FW 551-600	0468660551
DEK 6 FW 601-650	0468660601
DEK 6 FW 651-700	0468660651
DEK 6 FW 701-750	0468660701
DEK 6 FW 751-800	0468660751
DEK 6 FW 801-850	0468660801
DEK 6 FW 851-900	0468660851
DEK 6 FW 901-950	0468660901
DEK 6 FW 951-999	0468660951
DEK 6 FW L,N,PE	0632560000
DEK 6 FWZ 1-10	0518960001
DEK 6 FWZ 101-110	0518960101

Type	Order No.
DEK 6 FWZ 11-20	0518960011
DEK 6 FWZ 21-30	0518960021
DEK 6 FWZ 31-40	0518960031
DEK 6 FWZ 41-50	0518960041
DEK 6 FWZ 51-60	0518960051
DEK 6 FWZ 61-70	0518960061
DEK 6 FWZ 71-80	0518960071
DEK 6 FWZ 81-90	0518960081
DEK 6 FWZ 91-100	0518960091
DEK 6 FWZ L1-ERDE I.KRE	0631961203
DEK 6 FWZ L1-PE	0631961187
DEK 6 GW +	1318061198
DEK 6 GW -	1318061199
DEK 6 GW 1	0526960001
DEK 6 GW 10	0526960010
DEK 6 GW 2	0526960002
DEK 6 GW 3	0526960003
DEK 6 GW 4	0526960004
DEK 6 GW 5	0526960005
DEK 6 GW 6	0526960006
DEK 6 GW 8	0526960008
DEK 6 GW ERDE	1318061202
DEK 6 GW PE	1318061187
DEK 6,5 FS 1-50	0468260001
DEK 6,5 FS 101-150	0468260101
DEK 6,5 FS 51-100	0468260051
DEK 6,5 FSZ 1-10	0407360001
DEK 6,5 FSZ 11-20	0407360011
DEK 6,5 FW 1-50	0468160001
DEK 6,5 FW 101-150	0468160101
DEK 6,5 FW 51-100	0468160051
DEK 6,5 FW L1-ERDE I.KR	0632161203
DEK 6,5 FWZ 1-10	0519060001
DEK 6,5 FWZ 11-20	0519060011
DEK 6,5 FWZ 21-30	0519060021
DEK 8 FS 1-50 TAMPOPR.	1653350001
DEK 8 FSZ 1-10	1289660001
DEK 8 FSZ 11-20	1289660011
DEK 8 FSZ 21-30	1289660021
DEK 8 FSZ 31-40	1289660031
DEK 8 FSZ 41-50	1289660041
DEK 8 FSZ 51-60	1289660051
DEK 8 FW 1-50 TAMPOPR.	1653340001
DEK 8 FW 51-100 TAMPOPR.	1653340051
DEK 8 FWZ 1-10	1276960001
DEK 8 FWZ 11-20	1276960011
DEK 8 FWZ 21-30	1276960021
DEK 8 FWZ 31-40	1276960031
DEK 8 FWZ 41-50	1276960041
DEK 8 FWZ 51-60	1276960051

## CableLine®

### The programme of products for all wire markings

#### Individual laser markers as a combined system

Our well matched selection of CableLine products provides you with everything you need for all your professional marking requirements. The combination of systems are defined by the application and contain the following: open and closed cross-section markers from 0.5 to 70 mm<sup>2</sup>, individual markers, transparent sleeves and markers for cable tie assembly. They are available in plastic or stainless steel, with the appropriate accessories and with the labelling options; these products optimally fulfil a wide range of requirements. The laser system used by Weidmüller produces abrasive-resistant print with brilliant quality.

#### CableLine® - the benefits to you

- No print system necessary
- Simple retrospect changes on site possible

#### The CableLine® programme comprises

- Wire markers
- Cable markers
- Standard or customer special print
- Accessories and tools
- Available in PVC or stainless steel versions



Closed marking from type CLI C with permanent fit. Mounted by sliding onto the wire end.



Open marker from type CLI O also allows mounting onto already connected wires.



Markers from type CLI M are pushed onto holding strips of type CLI MH and finally mounted with cable ties.



# CableLine® packaging types



## Technical data

	Type	max. characters per marker SDR	Marker length mm	CD	MultiPack	Box	Looped strip	
	CLI C 02-3	1	3	500	1000 (5 x 200)	-	-	
	CLI C 02-6	2	6	250	1000 (5 x 200)	-	1000	
	CLI C 02-9	3	9	125	500 (5 x 100)	-	1000	
	CLI C 02-12	4	12	-	-	-	1000	
	CLI C 02-15	5	15	-	-	-	1000	
	CLI C 02-18	8	18	-	-	-	1000	
	CLI C 02-21	10	21	-	-	-	1000	
	CLI C 1-3	1	3	500	1000 (5 x 200)	-	-	
	CLI C 1-6	2	6	250	500 (5 x 100)	-	1000	
	CLI C 1-9	3	9	125	500 (5 x 100)	-	1000	
	CLI C 1-12	4	12	-	-	-	1000	
	CLI C 1-15	5	15	-	-	-	1000	
	CLI C 1-18	8	18	-	-	-	1000	
	CLI C 1-21	10	21	-	-	-	1000	
	CLI C 1-24	12	24	-	-	-	1000	
	CLI C 1-33	17	33	-	-	-	1000	
	CLI C 2-4	1	4	250	500 (5 x 100)	-	-	
	CLI C 2-6	2	6	125	500 (5 x 100)	-	1000	
	CLI C 2-9	3	9	125	500 (5 x 100)	-	1000	
	CLI C 2-12	4	12	-	-	-	1000	
	CLI C 2-15	6	15	-	-	-	1000	
	CLI C 2-18	8	18	-	-	-	1000	
	CLI C 2-21	10	21	-	-	-	1000	
	CLI C 3-6	2	6	-	100 (5 x 20)	-	1000	
	CLI C 3-9	3	9	-	100 (5 x 20)	-	1000	
	CLI C 3-12	4	12	-	-	-	1000	
	CLI C 3-15	5	15	-	-	-	1000	
	CLI C 3-18	8	18	-	-	-	1000	
	CLI C 3-21	10	21	-	-	-	1000	
		CLI O 10-3	1	3	-	1000 (5 x 200)	-	-
		CLI O 20-3	1	3	-	1000 (5 x 200)	-	-
		CLI O 30-3	1	3	-	1000 (5 x 200)	-	-
		CLI M 2-4	1	4	500	500 (5 x 100)	-	-
CLI M 2-6		2	6	250	500 (5 x 100)	-	1000	
CLI M 2-9		3	9	125	-	-	1000	
CLI M 2-12		4	12	-	-	-	1000	
CLI M 2-21		10	21	-	-	-	1000	
CLI M 2-250		12	25	-	-	-	1000	
CLI M 2-400		21	40	-	-	-	1000	
	CLI MH-70	-	70	-	-	100	-	
	CLI MH-110	-	110	-	-	100	-	

# CLI C – Closed wire markers

CLI C wire markers are fitted to unconnected cables. Four different sizes are available to mark wire cross-sections from 0.5 mm<sup>2</sup> to maximum 70 mm<sup>2</sup>. The markers are already printed and ready for use. Individual markings can be created by simply combining the individual markers.

### Advantages:

- Closed markers, secure and adjustable for unconnected cables
- Special resilient bellow profile ensures a wide application range
- Fast and easy to fit – in next to no time
- Compatible accessories take the strain off marking tasks
- Permanent high-quality markings
- Best contrast for optimum legibility

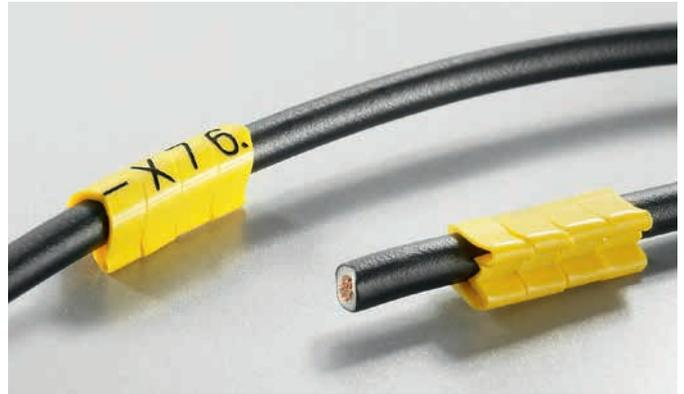

Closed marking from type CLI C with permanent fit. Mounted by sliding onto the wire end.

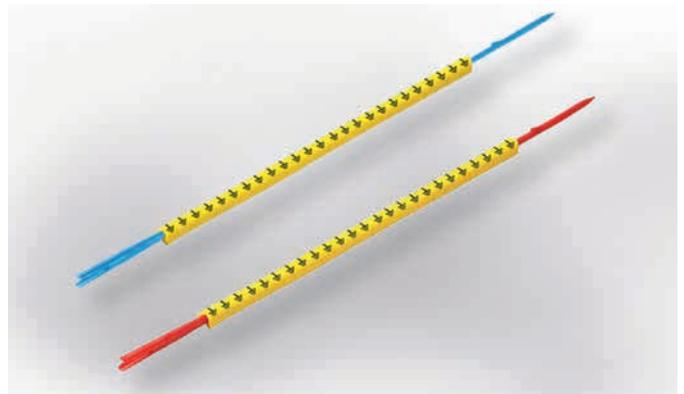

CLI R are pre-assembled mounting mandrels with CLI C markers.

### CLI C

Version	Closed markers made from soft PVC. Resilient bellow construction enables fast and easy attachment. Standard, special and international colour-code compliant prints available.
Material	Soft PVC, cadmium- and silicone-free
Temperature range	-30 °C ... 80 °C
Flammability classification	Corresponds to V0 to UL 94
Resistance	Highly resistant to oils and petrol as well as gamma and UV radiation
Printing	Laser marking

### Wire cross-section

CLI C02	0.5 mm <sup>2</sup> - 1.5 mm <sup>2</sup>
CLI C 1	1.5 mm <sup>2</sup> - 4 mm <sup>2</sup>
CLI C 2	2.5 mm <sup>2</sup> - 16 mm <sup>2</sup>
CLI C 3	16 mm <sup>2</sup> - 70 mm <sup>2</sup>

**CLI C 02 Blank (CD)****Technical data**

Material	Fire class acc. to UL 94	Temperature range	Wire O.D.	Version
PVC, soft, without Cadmium	V-0	-30 °C...80 °C	1.3 - 3 mm	CD

**Ordering data**

Order No.	Type	Colour	Depth / Width	Printing	Qty.
1568241058	CLI C 02-3 GE NE CD	● yellow	3.5 / 3.4 mm	Blank	500

**CLI C 02 Blank (MultiPack)****Technical data**

Material	Fire class acc. to UL 94	Temperature range	Wire O.D.	Version
PVC, soft, without Cadmium	V-0	-30 °C...80 °C	1.3 - 3 mm	MultiPack

**Ordering data**

Order No.	Type	Colour	Depth / Width	Printing	Qty.
0213811687	CLI C 02-3 GE NE MP	● yellow	3.5 / 3.5 mm	Blank	200

**CLI C 02 Blank (on loop)****Technical data**

Material	Fire class acc. to UL 94	Temperature range	Wire O.D.	Version
PVC, soft, without Cadmium	V-0	-30 °C...80 °C	1.3 - 3 mm	Loop

**Ordering data**

Order No.	Type	Colour	Depth / Width	Printing	Qty.
1873741687	CLI C 02-18 GE NE SG	● yellow	3.5 / 3.4 mm	Neutral	1000

**CLI C 1 Blank (MultiPack)****Technical data**

Material	Fire class acc. to UL 94	Temperature range	Wire O.D.	Version
PVC, soft, without Cadmium	V-0	-30 °C...80 °C	2.5 - 5 mm	MultiPack

**Ordering data**

Order No.	Type	Colour	Depth / Width	Printing	Qty.
0171111687	CLI C 1-3 GE NE MP	● yellow	5 / 4.2 mm	Blank	200



### CLI C 1 Blank (CD)

#### Technical data

Material	Fire class acc. to UL 94	Temperature range	Wire O.D.	Version
PVC, soft, without Cadmium	V-0	-30 °C...80 °C	2.5 - 5 mm	CD

#### Ordering data

Order No.	Type	Colour	Depth / Width	Printing	Qty.
1568251693	CLI C 1-3 BL NE CD	● blue	5 / 4.2 mm	Blank	500
1568251699	CLI C 1-3 GE NE CD	● yellow	5 / 4.2 mm	Blank	500
1568251688	CLI C 1-3 GN NE CD	● green	5 / 4.2 mm	Blank	500
1568251691	CLI C 1-3 GR NE CD	● grey	5 / 4.2 mm	Blank	500
1568251686	CLI C 1-3 RT NE CD	● red	5 / 4.2 mm	Blank	500
1568251694	CLI C 1-3 SW NE CD	● black	5 / 4.2 mm	Blank	500
1568251044	CLI C 1-3 WS NE CD	○ white	5 / 4.2 mm	Blank	500
1868811687	CLI C 1-6 GE NE CD	● yellow	5 / 4.2 mm	Blank	250



### CLI C1 Blank (on loop)

#### Technical data

Material	Fire class acc. to UL 94	Temperature range	Wire O.D.	Version
PVC, soft, without Cadmium	V-0	-30 °C...80 °C	2.5 - 5 mm	Loop

#### Ordering data

Order No.	Type	Colour	Depth / Width	Printing	Qty.
1871801687	CLI C 1-18 GE NE SG	● yellow	5 / 4.2 mm	Neutral	1000

### CLI C 2 Blank (CD)

#### Technical data

Material	Fire class acc. to UL 94	Temperature range	Wire O.D.	Version
PVC, soft, without Cadmium	V-0	-30 °C...60 °C	4 - 10 mm	CD

#### Ordering data

Order No.	Type	Colour	Depth / Width	Printing	Qty.
0171301687	CLI C 2-4 GE NE CD	● yellow	8 / 6.9 mm	Blank	250
1871971687	CLI C 2-9 GE NE CD	● yellow	8 / 6.9 mm	Blank	125



### CLI C 2 Blank (on loop)

#### Technical data

Material	Fire class acc. to UL 94	Temperature range	Wire O.D.	Version
PVC, soft, without Cadmium	V-0	-30 °C...60 °C	4 - 10 mm	Loop

#### Ordering data

Order No.	Type	Colour	Depth / Width	Printing	Qty.
1871831687	CLI C 2-18 GE NE SG	● yellow	8 / 6.9 mm	Neutral	1000



**CLI C 02 Custom Printing (CD)****Technical data**

Material	Fire class acc. to UL 94	Temperature range	Wire O.D.	Version
PVC, soft, without Cadmium	V-0	80 °C	1.3 - 3 mm	CD

**Ordering data**

Order No.	Type	Colour	Depth / Width	Printing	Qty.
1568249999	CLI C 02-3 SDR CD	CSP	3.5 / 3.4 mm	Custom printing	500
1869999999	CLI C 02-6 SDR CD	CSP	3.5 / 3.4 mm	Custom printing	250
1899290000	CLI C 02-9 SDR CD	CSP	3.5 / 3.4 mm	Custom printing	125

**CLI C 02 Custom printing (on loop)****Technical data**

Material	Fire class acc. to UL 94	Temperature range	Wire O.D.	Version
PVC, soft, without Cadmium	V-0	80 °C	1.3 - 3 mm	Loop

**Ordering data**

Order No.	Type	Colour	Depth / Width	Printing	Qty.
1912550000	CLI C 02-3 SDR SG	CSP	3.5 / 3.4 mm	Custom printing	100
1873330000	CLI C 02-12 SDR SG	CSP	3.5 / 3.4 mm	Custom printing	100
0252509999	CLI C 02-15 SDR SG	CSP	3.5 / 3.4 mm	Custom printing	100
1873749999	CLI C 02-18 SDR SG	CSP	3.5 / 3.4 mm	Custom printing	100
1873340000	CLI C 02-21 SDR SG	CSP	3.5 / 3.4 mm	Custom printing	100
1912500000	CLI C 02-24 SDR SG	CSP	3.5 / 3.4 mm	Custom printing	100
1912510000	CLI C 02-27 SDR SG	CSP	3.5 / 3.4 mm	Custom printing	100
1912580000	CLI C 02-30 SDR SG	CSP	3.5 / 3.4 mm	Custom printing	100
1912590000	CLI C 02-33 SDR SG	CSP	3.5 / 3.4 mm	Custom printing	100
1912600000	CLI C 02-36 SDR SG	CSP	3.5 / 3.4 mm	Custom printing	100
1912610000	CLI C 02-39 SDR SG	CSP	3.5 / 3.4 mm	Custom printing	100

**CLI C 1 Custom Printing (CD)****Technical data**

Material	Fire class acc. to UL 94	Temperature range	Wire O.D.	Version
PVC, soft, without Cadmium	V-0	80 °C	2.5 - 5 mm	CD

**Ordering data**

Order No.	Type	Colour	Depth / Width	Printing	Qty.
1568259999	CLI C 1-3 SDR CD	CSP	5 / 4.2 mm	Custom printing	500
0252709999	CLI C 1-6 SDR CD	CSP	5 / 4.2 mm	Custom printing	250
0252809999	CLI C 1-9 SDR CD	CSP	5 / 4.2 mm	Custom printing	125



### CLI C 1 Custom printing (on loop)

#### Technical data

Material	Fire class acc. to UL 94	Temperature range	Wire O.D.	Version
PVC, soft, without Cadmium	V-0	80 °C	2.5 - 5 mm	Loop

#### Ordering data

Order No.	Type	Colour	Depth / Width	Printing	Qty.
1912650000	CLI C 1-3 SDR SG	CSP	5 / 4.2 mm	Custom printing	100
1912700000	CLI C 1-6 SDR SG	CSP	5 / 4.2 mm	Custom printing	100
1868819999	CLI C 1-9 SDR SG	CSP	5 / 4.2 mm	Custom printing	100
1873350000	CLI C 1-12 SDR SG	CSP	5 / 4.2 mm	Custom printing	100
1873360000	CLI C 1-15 SDR SG	CSP	5 / 4.2 mm	Custom printing	50
1871809999	CLI C 1-18 SDR SG	CSP	5 / 4.2 mm	Custom printing	100
1873370000	CLI C 1-21 SDR SG	CSP	5 / 4.2 mm	Custom printing	100
1912640000	CLI C 1-27 SDR SG	CSP	5 / 4.2 mm	Custom printing	100
1912660000	CLI C 1-30 SDR SG	CSP	5 / 4.2 mm	Custom printing	100
1912670000	CLI C 1-33 SDR SG	CSP	5 / 4.2 mm	Custom printing	100
1912680000	CLI C 1-39 SDR SG	CSP	5 / 4.2 mm	Custom printing	100



### CLI C 2 Custom Printing (CD)

#### Technical data

Material	Fire class acc. to UL 94	Temperature range	Wire O.D.	Version
PVC, soft, without Cadmium	V-0	80 °C	4 - 10 mm	CD

#### Ordering data

Order No.	Type	Colour	Depth / Width	Printing	Qty.
1568269999	CLI C 2-4 SDR CD	CSP	8 / 6.9 mm	Custom printing	250
1871909999	CLI C 2-6 SDR CD	CSP	8 / 6.9 mm	Custom printing	125
1899240000	CLI C 2-9 SDR CD	CSP	8 / 6.9 mm	Custom printing	100



### CLI C 2 Custom printing (on loop)

#### Technical data

Material	Fire class acc. to UL 94	Temperature range	Wire O.D.	Version
PVC, soft, without Cadmium	V-0	80 °C	4 - 10 mm	Loop

#### Ordering data

Order No.	Type	Colour	Depth / Width	Printing	Qty.
1871979999	CLI C 2-9 SDR SG	CSP	8 / 6.9 mm	Custom printing	100
1873380000	CLI C 2-12 SDR SG	CSP	8 / 6.9 mm	Custom printing	100
1873390000	CLI C 2-15 SDR SG	CSP	8 / 6.9 mm	Custom printing	100
1871839999	CLI C 2-18 SDR SG	CSP	8 / 6.9 mm	Custom printing	100
1873400000	CLI C 2-21 SDR SG	CSP	8 / 6.9 mm	Custom printing	100
1912710000	CLI C 2-24 SDR SG	CSP	8 / 6.9 mm	Custom printing	100
1912720000	CLI C 2-27 SDR SG	CSP	8 / 6.9 mm	Custom printing	100
1912730000	CLI C 2-30 SDR SG	CSP	8 / 6.9 mm	Custom printing	100
1912740000	CLI C 2-33 SDR SG	CSP	8 / 6.9 mm	Custom printing	100
1912750000	CLI C 2-36 SDR SG	CSP	8 / 6.9 mm	Custom printing	100
1912760000	CLI C 2-39 SDR SG	CSP	8 / 6.9 mm	Custom printing	100



## CLI C 3 Custom Printing (on loop)

## Technical data

Material	Fire class acc. to UL 94	Temperature range	Wire O.D.	Version
PVC, soft, without Cadmium	V-0	80 °C	8 - 16 mm	Loop

## Ordering data

Order No.	Type	Colour	Depth / Width	Printing	Qty.
1872309999	CLI C 3-6 SDR SG	CSP	17 / 11 mm	Custom printing	100
1872659999	CLI C 3-9 SDR SG	CSP	17 / 11 mm	Custom printing	100
1873420000	CLI C 3-12 SDR SG	CSP	17 / 11 mm	Custom printing	100
1873430000	CLI C 3-15 SDR SG	CSP	17 / 11 mm	Custom printing	100
1872679999	CLI C 3-18 SDR SG	CSP	17 / 11 mm	Custom printing	100
1873410000	CLI C 3-21 SDR SG	CSP	17 / 11 mm	Custom printing	100
1912770000	CLI C 3-24 SDR SG	CSP	17 / 11 mm	Custom printing	100
1912780000	CLI C 3-27 SDR SG	CSP	17 / 11 mm	Custom printing	100
1912790000	CLI C 3-30 SDR SG	CSP	17 / 11 mm	Custom printing	100
1912800000	CLI C 3-33 SDR SG	CSP	17 / 11 mm	Custom printing	100
1912810000	CLI C 3-36 SDR SG	CSP	17 / 11 mm	Custom printing	100
1912820000	CLI C 3-39 SDR SG	CSP	17 / 11 mm	Custom printing	100



## CLI C 02-3 International colour code (MultiPack)

## Technical data

Material	Fire class acc. to UL 94	Temperature range	Wire O.D.	Version
PVC, soft, without Cadmium	V-0	-30 °C...80 °C	1.3 - 3 mm	MultiPack

## Ordering data

Order No.	Type	Colour	Depth / Width	Printing	Qty.
0252111503	CLI C 02-3 SW/WS 0 MP	● black	3.5 / 3.4 mm	0	200
0252111506	CLI C 02-3 BR/WS 1 MP	● brown	3.5 / 3.4 mm	1	200
0252111509	CLI C 02-3 RT/WS 2 MP	● red	3.5 / 3.4 mm	2	200
0252111512	CLI C 02-3 OR/SW 3 MP	● orange	3.5 / 3.4 mm	3	200
0252111514	CLI C 02-3 GE/SW 4 MP	● yellow	3.5 / 3.4 mm	4	200
0252111518	CLI C 02-3 GN/WS 5 MP	● green	3.5 / 3.4 mm	5	200
0252111521	CLI C 02-3 BL/WS 6 MP	● blue	3.5 / 3.4 mm	6	200
0252111524	CLI C 02-3 VI/WS 7 MP	● violet	3.5 / 3.4 mm	7	200
0252111527	CLI C 02-3 GR/SW 8 MP	● grey	3.5 / 3.4 mm	8	200
0252111530	CLI C 02-3 WS/SW 9 MP	○ white	3.5 / 3.4 mm	9	200



CLI C 02-3 Alphabetic (MultiPack)

Technical data

Material	Fire class acc. to UL 94	Temperature range	Wire O.D.	Version
PVC, soft, without Cadmium	V-0	-30 °C...80 °C	1.3 - 3 mm	MultiPack

Ordering data

Order No.	Type	Colour	Depth / Width	Printing	Qty.
0252111637	CLI C 02-3 GE/SW A MP	● yellow	3.5 / 3.4 mm	A	200
0252111639	CLI C 02-3 GE/SW B MP	● yellow	3.5 / 3.4 mm	B	200
0252111641	CLI C 02-3 GE/SW C MP	● yellow	3.5 / 3.4 mm	C	200
0252111643	CLI C 02-3 GE/SW D MP	● yellow	3.5 / 3.4 mm	D	200
0252111645	CLI C 02-3 GE/SW E MP	● yellow	3.5 / 3.4 mm	E	200
0252111647	CLI C 02-3 GE/SW F MP	● yellow	3.5 / 3.4 mm	F	200
0252111649	CLI C 02-3 GE/SW G MP	● yellow	3.5 / 3.4 mm	G	200
0252111651	CLI C 02-3 GE/SW H MP	● yellow	3.5 / 3.4 mm	H	200
0252111653	CLI C 02-3 GE/SW I MP	● yellow	3.5 / 3.4 mm	I	200
0252111655	CLI C 02-3 GE/SW J MP	● yellow	3.5 / 3.4 mm	J	200
0252111657	CLI C 02-3 GE/SW K MP	● yellow	3.5 / 3.4 mm	K	200
0252111659	CLI C 02-3 GE/SW L MP	● yellow	3.5 / 3.4 mm	L	200
0252111661	CLI C 02-3 GE/SW M MP	● yellow	3.5 / 3.4 mm	M	200
0252111663	CLI C 02-3 GE/SW N MP	● yellow	3.5 / 3.4 mm	N	200
0252111665	CLI C 02-3 GE/SW O MP	● yellow	3.5 / 3.4 mm	O	200
0252111667	CLI C 02-3 GE/SW P MP	● yellow	3.5 / 3.4 mm	P	200
0252111669	CLI C 02-3 GE/SW Q MP	● yellow	3.5 / 3.4 mm	Q	200
0252111671	CLI C 02-3 GE/SW R MP	● yellow	3.5 / 3.4 mm	R	200
0252111673	CLI C 02-3 GE/SW S MP	● yellow	3.5 / 3.4 mm	S	200
0252111676	CLI C 02-3 GE/SW T MP	● yellow	3.5 / 3.4 mm	T	200
0252111679	CLI C 02-3 GE/SW U MP	● yellow	3.5 / 3.4 mm	U	200
0252111681	CLI C 02-3 GE/SW V MP	● yellow	3.5 / 3.4 mm	V	200
0252111683	CLI C 02-3 GE/SW W MP	● yellow	3.5 / 3.4 mm	W	200
0252111687	CLI C 02-3 GE/SW X MP	● yellow	3.5 / 3.4 mm	X	200
0252111696	CLI C 02-3 GE/SW Y MP	● yellow	3.5 / 3.4 mm	Y	200
0252111698	CLI C 02-3 GE/SW Z MP	● yellow	3.5 / 3.4 mm	Z	200



CLI C 02-3 Special characters (MultiPack)

Technical data

Material	Fire class acc. to UL 94	Temperature range	Wire O.D.	Version
PVC, soft, without Cadmium	V-0	-30 °C...80 °C	1.3 - 3 mm	MultiPack

Ordering data

Order No.	Type	Colour	Depth / Width	Printing	Qty.
0252111742	CLI C 02-3 GE/SW / MP	● yellow	3.5 / 3.4 mm	/	200
0252111738	CLI C 02-3 GE/SW + MP	● yellow	3.5 / 3.4 mm	+	200
0252111740	CLI C 02-3 GE/SW - MP	● yellow	3.5 / 3.4 mm	-	200
0252111748	CLI C 02-3 GE/SW . MP	● yellow	3.5 / 3.4 mm	.	200
0252111750	CLI C 02-3 GE/SW : MP	● yellow	3.5 / 3.4 mm	:	200
0252111751	CLI C 02-3 GE/SW = MP	● yellow	3.5 / 3.4 mm	=	200
0252111752	CLI C 02-3 GE/SW AC MP	● yellow	3.5 / 3.4 mm	AC	200
0252111746	CLI C 02-3 GE/SW ET MP	● yellow	3.5 / 3.4 mm	⊥	200
0252111697	CLI C 02-3 GE/SW Å MP	● yellow	3.5 / 3.4 mm	Å	200
0252111699	CLI C 02-3 GE/SW Ä MP	● yellow	3.5 / 3.4 mm	Ä	200
1568241735	CLI C 02-3 GE/SW Æ CD	● yellow	3.5 / 3.4 mm	Æ	500
0252111695	CLI C 02-3 GE/SW Ö MP	● yellow	3.5 / 3.4 mm	Ö	200
1568241736	CLI C 02-3 GE/SW Ø CD	● yellow	3.5 / 3.4 mm	Ø	500
0252111741	CLI C 02-3 BL/WS - MP	● blue	3.5 / 3.4 mm	-	200
0252111737	CLI C 02-3 RT/WS + MP	● red	3.5 / 3.4 mm	+	200





## CLI C 02-3 International colour code (CD)

## Technical data

Material	Fire class acc. to UL 94	Temperature range	Wire O.D.	Version
PVC, soft, without Cadmium	V-0	-30 °C...80 °C	1.3 - 3 mm	CD

## Ordering data

Order No.	Type	Colour	Depth / Width	Printing	Qty.
1568241503	CLI C 02-3 SW/WS 0 CD	● black	3.5 / 3.4 mm	0	500
1568241506	CLI C 02-3 BR/WS 1 CD	● brown	3.5 / 3.4 mm	1	500
1568241509	CLI C 02-3 RT/WS 2 CD	● red	3.5 / 3.4 mm	2	500
1568241512	CLI C 02-3 OR/SW 3 CD	● orange	3.5 / 3.4 mm	3	500
1568241514	CLI C 02-3 GE/SW 4 CD	● yellow	3.5 / 3.4 mm	4	500
1568241518	CLI C 02-3 GN/WS 5 CD	● green	3.5 / 3.4 mm	5	500
1568241521	CLI C 02-3 BL/WS 6 CD	● blue	3.5 / 3.4 mm	6	500
1568241524	CLI C 02-3 VI/WS 7 CD	● violet	3.5 / 3.4 mm	7	500
1568241527	CLI C 02-3 GR/SW 8 CD	● grey	3.5 / 3.4 mm	8	500
1568241530	CLI C 02-3 WS/SW 9 CD	○ white	3.5 / 3.4 mm	9	500



## CLI C 02-3 Numeric sequence (CD)

## Technical data

Material	Fire class acc. to UL 94	Temperature range	Wire O.D.	Version
PVC, soft, without Cadmium	V-0	-30 °C...80 °C	1.3 - 3 mm	CD

## Ordering data

Order No.	Type	Colour	Depth / Width	Printing	Qty.
1568241502	CLI C 02-3 GE/SW 0 CD	● yellow	3.5 / 3.4 mm	0	500
1869821502	CLI C 02-3 WS/SW 0 CD	○ white	3.5 / 3.4 mm	0	500
1568241505	CLI C 02-3 GE/SW 1 CD	● yellow	3.5 / 3.4 mm	1	500
1869821505	CLI C 02-3 WS/SW 1 CD	○ white	3.5 / 3.4 mm	1	500
1568241508	CLI C 02-3 GE/SW 2 CD	● yellow	3.5 / 3.4 mm	2	500
1869821508	CLI C 02-3 WS/SW 2 CD	○ white	3.5 / 3.4 mm	2	500
1568241511	CLI C 02-3 GE/SW 3 CD	● yellow	3.5 / 3.4 mm	3	500
1869821511	CLI C 02-3 WS/SW 3 CD	○ white	3.5 / 3.4 mm	3	500
1568241514	CLI C 02-3 GE/SW 4 CD	● yellow	3.5 / 3.4 mm	4	500
1869821514	CLI C 02-3 WS/SW 4 CD	○ white	3.5 / 3.4 mm	4	500
1568241517	CLI C 02-3 GE/SW 5 CD	● yellow	3.5 / 3.4 mm	5	500
1869821517	CLI C 02-3 WS/SW 5 CD	○ white	3.5 / 3.4 mm	5	500
1568241520	CLI C 02-3 GE/SW 6 CD	● yellow	3.5 / 3.4 mm	6	500
1869821520	CLI C 02-3 WS/SW 6 CD	○ white	3.5 / 3.4 mm	6	500
1568241523	CLI C 02-3 GE/SW 7 CD	● yellow	3.5 / 3.4 mm	7	500
1869821523	CLI C 02-3 WS/SW 7 CD	○ white	3.5 / 3.4 mm	7	500
1568241526	CLI C 02-3 GE/SW 8 CD	● yellow	3.5 / 3.4 mm	8	500
1869821526	CLI C 02-3 WS/SW 8 CD	○ white	3.5 / 3.4 mm	8	500
1568241529	CLI C 02-3 GE/SW 9 CD	● yellow	3.5 / 3.4 mm	9	500
1568241530	CLI C 02-3 WS/SW 9 CD	○ white	3.5 / 3.4 mm	9	500



## CLI C 02-3 Alphabetic (CD)

## Technical data

Material	Fire class acc. to UL 94	Temperature range	Wire O.D.	Version
PVC, soft, without Cadmium	V-0	-30 °C...80 °C	1.3 - 3 mm	CD

## Ordering data

Order No.	Type	Colour	Depth / Width	Printing	Qty.
1568241637	CLI C 02-3 GE/SW A CD	● yellow	3.5 / 3.4 mm	A	500
1568241639	CLI C 02-3 GE/SW B CD	● yellow	3.5 / 3.4 mm	B	500
1568241641	CLI C 02-3 GE/SW C CD	● yellow	3.5 / 3.4 mm	C	500
1568241643	CLI C 02-3 GE/SW D CD	● yellow	3.5 / 3.4 mm	D	500
1568241645	CLI C 02-3 GE/SW E CD	● yellow	3.5 / 3.4 mm	E	500
1568241647	CLI C 02-3 GE/SW F CD	● yellow	3.5 / 3.4 mm	F	500
1568241649	CLI C 02-3 GE/SW G CD	● yellow	3.5 / 3.4 mm	G	500
1568241651	CLI C 02-3 GE/SW H CD	● yellow	3.5 / 3.4 mm	H	500
1568241653	CLI C 02-3 GE/SW I CD	● yellow	3.5 / 3.4 mm	I	500
1568241655	CLI C 02-3 GE/SW J CD	● yellow	3.5 / 3.4 mm	J	500
1568241657	CLI C 02-3 GE/SW K CD	● yellow	3.5 / 3.4 mm	K	500
1568241659	CLI C 02-3 GE/SW L CD	● yellow	3.5 / 3.4 mm	L	500
1568241661	CLI C 02-3 GE/SW M CD	● yellow	3.5 / 3.4 mm	M	500
1568241663	CLI C 02-3 GE/SW N CD	● yellow	3.5 / 3.4 mm	N	500
1568241665	CLI C 02-3 GE/SW O CD	● yellow	3.5 / 3.4 mm	O	500
1568241667	CLI C 02-3 GE/SW P CD	● yellow	3.5 / 3.4 mm	P	500
1568241669	CLI C 02-3 GE/SW Q CD	● yellow	3.5 / 3.4 mm	Q	500
1568241671	CLI C 02-3 GE/SW R CD	● yellow	3.5 / 3.4 mm	R	500
1568241673	CLI C 02-3 GE/SW S CD	● yellow	3.5 / 3.4 mm	S	500
1568241676	CLI C 02-3 GE/SW T CD	● yellow	3.5 / 3.4 mm	T	500
1568241679	CLI C 02-3 GE/SW U CD	● yellow	3.5 / 3.4 mm	U	500
1568241681	CLI C 02-3 GE/SW V CD	● yellow	3.5 / 3.4 mm	V	500
1568241683	CLI C 02-3 GE/SW W CD	● yellow	3.5 / 3.4 mm	W	500
1568241687	CLI C 02-3 GE/SW X CD	● yellow	3.5 / 3.4 mm	X	500
1568241696	CLI C 02-3 GE/SW Y CD	● yellow	3.5 / 3.4 mm	Y	500
1568241698	CLI C 02-3 GE/SW Z CD	● yellow	3.5 / 3.4 mm	Z	500



## CLI C 02-3 Special characters (CD)

## Technical data

Material	Fire class acc. to UL 94	Temperature range	Wire O.D.	Version
PVC, soft, without Cadmium	V-0	-30 °C...80 °C	1.3 - 3 mm	CD

## Ordering data

Order No.	Type	Colour	Depth / Width	Printing	Qty.
1568241738	CLI C 02-3 GE/SW + CD	● yellow	3.5 / 3.4 mm	+	500
1568241740	CLI C 02-3 GE/SW - CD	● yellow	3.5 / 3.4 mm	-	500
1869821740	CLI C 02-3 WS/SW - CD	○ white	3.5 / 3.4 mm	-	500
1568241748	CLI C 02-3 GE/SW . CD	● yellow	3.5 / 3.4 mm	.	500
1568241742	CLI C 02-3 GE/SW / CD	● yellow	3.5 / 3.4 mm	/	500
1568241750	CLI C 02-3 GE/SW : CD	● yellow	3.5 / 3.4 mm	:	500
1568241751	CLI C 02-3 GE/SW = CD	● yellow	3.5 / 3.4 mm	=	500
1568241752	CLI C 02-3 GE/SW AC CD	● yellow	3.5 / 3.4 mm	AC	500
1568241746	CLI C 02-3 GE/SW ET CD	● yellow	3.5 / 3.4 mm	⊥	500
1568241747	CLI C 02-3 GE/SW PET. CD	● yellow	3.5 / 3.4 mm	⊕	500
1568241056	CLI C 02-3 GE/SW Å CD	● yellow	3.5 / 3.4 mm	Å	500
1568241055	CLI C 02-3 GE/SW Ä CD	● yellow	3.5 / 3.4 mm	Ä	500
1568241057	CLI C 02-3 GE/SW Ö CD	● yellow	3.5 / 3.4 mm	Ö	500
1568241741	CLI C 02-3 BL/WS - CD	● blue	3.5 / 3.4 mm	-	500
1568241737	CLI C 02-3 RT/WS + CD	● red	3.5 / 3.4 mm	+	500



**CLI C 02-6 Special characters (CD)****Technical data**

Material	Fire class acc. to UL 94	Temperature range	Wire O.D.	Version
PVC, soft, without Cadmium	V-0	-30 °C...80 °C	1.3 - 3 mm	CD

**Ordering data**

Order No.	Type	Colour	Depth / Width	Printing	Qty.
1568241726	CLI C 02-6 GE/SW A1 CD	● yellow	3.5 / 3.4 mm	A1	250
1568241727	CLI C 02-6 GE/SW A2 CD	● yellow	3.5 / 3.4 mm	A2	250
1568241728	CLI C 02-6 GE/SW L1 CD	● yellow	3.5 / 3.4 mm	L1	250
1568241729	CLI C 02-6 GE/SW L2 CD	● yellow	3.5 / 3.4 mm	L2	250
1568241730	CLI C 02-6 GE/SW L3 CD	● yellow	3.5 / 3.4 mm	L3	250

**CLI C 02-6 Special characters (MultiPack)****Technical data**

Material	Fire class acc. to UL 94	Temperature range	Wire O.D.	Version
PVC, soft, without Cadmium	V-0	-30 °C...80 °C	1.3 - 3 mm	MultiPack

**Ordering data**

Order No.	Type	Colour	Depth / Width	Printing	Qty.
0252111726	CLI C 02-6 GE/SW A1 MP	● yellow	3.5 / 3.4 mm	A1	100
0252111727	CLI C 02-6 GE/SW A2 MP	● yellow	3.5 / 3.4 mm	A2	100
0252111728	CLI C 02-6 GE/SW L1 MP	● yellow	3.5 / 3.4 mm	L1	100
0252111729	CLI C 02-6 GE/SW L2 MP	● yellow	3.5 / 3.4 mm	L2	100
0252111730	CLI C 02-6 GE/SW L3 MP	● yellow	3.5 / 3.4 mm	L3	100

**CLI C 02-9 Special characters (MultiPack)****Technical data**

Material	Fire class acc. to UL 94	Temperature range	Wire O.D.	Version
PVC, soft, without Cadmium	V-0	-30 °C...80 °C	1.3 - 3 mm	MultiPack

**Ordering data**

Order No.	Type	Colour	Depth / Width	Printing	Qty.
0252111734	CLI C 02-9 GE/SW PEN MP	● yellow	3.5 / 3.4 mm	PEN	100

**CLI C 02-9 Special characters (CD)****Technical data**

Material	Fire class acc. to UL 94	Temperature range	Wire O.D.	Version
PVC, soft, without Cadmium	V-0	-30 °C...80 °C	1.3 - 3 mm	CD

**Ordering data**

Order No.	Type	Colour	Depth / Width	Printing	Qty.
1568241734	CLI C 02-9 GE/SW PEN CD	● yellow	3.5 / 3.4 mm	PEN	125



**CLI C 1-3 International colour code (MultiPack)**

**Technical data**

Material	Fire class acc. to UL 94	Temperature range	Wire O.D.	Version
PVC, soft, without Cadmium	V-0	-30 °C...80 °C	2.5 - 5 mm	MultiPack

**Ordering data**

Order No.	Type	Colour	Depth / Width	Printing	Qty.
0252611503	CLI C 1-3 SW/WS 0 MP	● black	5 / 4.2 mm	0	200
0252611506	CLI C 1-3 BR/WS 1 MP	● brown	5 / 4.2 mm	1	200
0252611509	CLI C 1-3 RT/WS 2 MP	● red	5 / 4.2 mm	2	200
0252611512	CLI C 1-3 OR/SW 3 MP	● orange	5 / 4.2 mm	3	200
0252611514	CLI C 1-3 GE/SW 4 MP	● yellow	5 / 4.2 mm	4	200
0252611518	CLI C 1-3 GN/WS 5 MP	● green	5 / 4.2 mm	5	200
0252611521	CLI C 1-3 BL/WS 6 MP	● blue	5 / 4.2 mm	6	200
0252611524	CLI C 1-3 VI/WS 7 MP	● violet	5 / 4.2 mm	7	200
0252611527	CLI C 1-3 GR/SW 8 MP	● grey	5 / 4.2 mm	8	200
0252611530	CLI C 1-3 WS/SW 9 MP	○ white	5 / 4.2 mm	9	200



**CLI C 1-3 Numeric sequence (MultiPack)**

**Technical data**

Material	Fire class acc. to UL 94	Temperature range	Wire O.D.	Version
PVC, soft, without Cadmium	V-0	-30 °C...80 °C	2.5 - 5 mm	MultiPack

**Ordering data**

Order No.	Type	Colour	Depth / Width	Printing	Qty.
0252611502	CLI C 1-3 GE/SW 0 MP	● yellow	5 / 4.2 mm	0	200
0252611505	CLI C 1-3 GE/SW 1 MP	● yellow	5 / 4.2 mm	1	200
0252611508	CLI C 1-3 GE/SW 2 MP	● yellow	5 / 4.2 mm	2	200
0252611511	CLI C 1-3 GE/SW 3 MP	● yellow	5 / 4.2 mm	3	200
0252611514	CLI C 1-3 GE/SW 4 MP	● yellow	5 / 4.2 mm	4	200
0252611517	CLI C 1-3 GE/SW 5 MP	● yellow	5 / 4.2 mm	5	200
0252611520	CLI C 1-3 GE/SW 6 MP	● yellow	5 / 4.2 mm	6	200
0252611523	CLI C 1-3 GE/SW 7 MP	● yellow	5 / 4.2 mm	7	200
0252611526	CLI C 1-3 GE/SW 8 MP	● yellow	5 / 4.2 mm	8	200
0252611529	CLI C 1-3 GE/SW 9 MP	● yellow	5 / 4.2 mm	9	200



## CLI C 1-3 Alphabetic (MultiPack)

## Technical data

Material	Fire class acc. to UL 94	Temperature range	Wire O.D.	Version
PVC, soft, without Cadmium	V-0	-30 °C...80 °C	2.5 - 5 mm	MultiPack

## Ordering data

Order No.	Type	Colour	Depth / Width	Printing	Qty.
0252611637	CLI C 1-3 GE/SW A MP	● yellow	5 / 4.2 mm	A	200
0252611639	CLI C 1-3 GE/SW B MP	● yellow	5 / 4.2 mm	B	200
0252611641	CLI C 1-3 GE/SW C MP	● yellow	5 / 4.2 mm	C	200
0252611643	CLI C 1-3 GE/SW D MP	● yellow	5 / 4.2 mm	D	200
0252611645	CLI C 1-3 GE/SW E MP	● yellow	5 / 4.2 mm	E	200
0252611647	CLI C 1-3 GE/SW F MP	● yellow	5 / 4.2 mm	F	200
0252611649	CLI C 1-3 GE/SW G MP	● yellow	5 / 4.2 mm	G	200
0252611651	CLI C 1-3 GE/SW H MP	● yellow	5 / 4.2 mm	H	200
0252611653	CLI C 1-3 GE/SW I MP	● yellow	5 / 4.2 mm	I	200
0252611655	CLI C 1-3 GE/SW J MP	● yellow	5 / 4.2 mm	J	200
0252611657	CLI C 1-3 GE/SW K MP	● yellow	5 / 4.2 mm	K	200
0252611659	CLI C 1-3 GE/SW L MP	● yellow	5 / 4.2 mm	L	200
0252611661	CLI C 1-3 GE/SW M MP	● yellow	5 / 4.2 mm	M	200
0252611663	CLI C 1-3 GE/SW N MP	● yellow	5 / 4.2 mm	N	200
0252611665	CLI C 1-3 GE/SW O MP	● yellow	5 / 4.2 mm	O	200
0252611667	CLI C 1-3 GE/SW P MP	● yellow	5 / 4.2 mm	P	200
0252611669	CLI C 1-3 GE/SW Q MP	● yellow	5 / 4.2 mm	Q	200
0252611671	CLI C 1-3 GE/SW R MP	● yellow	5 / 4.2 mm	R	200
0252611673	CLI C 1-3 GE/SW S MP	● yellow	5 / 4.2 mm	S	200
0252611676	CLI C 1-3 GE/SW T MP	● yellow	5 / 4.2 mm	T	200
0252611679	CLI C 1-3 GE/SW U MP	● yellow	5 / 4.2 mm	U	200
0252611681	CLI C 1-3 GE/SW V MP	● yellow	5 / 4.2 mm	V	200
0252611683	CLI C 1-3 GE/SW W MP	● yellow	5 / 4.2 mm	W	200
0252611687	CLI C 1-3 GE/SW X MP	● yellow	5 / 4.2 mm	X	200
0252611696	CLI C 1-3 GE/SW Y MP	● yellow	5 / 4.2 mm	Y	200
0252611698	CLI C 1-3 GE/SW Z MP	● yellow	5 / 4.2 mm	Z	200



## CLI C 1-3 Special characters (MultiPack)

## Technical data

Material	Fire class acc. to UL 94	Temperature range	Wire O.D.	Version
PVC, soft, without Cadmium	V-0	-30 °C...80 °C	2.5 - 5 mm	MultiPack

## Ordering data

Order No.	Type	Colour	Depth / Width	Printing	Qty.
0252611738	CLI C 1-3 GE/SW + MP	● yellow	5 / 4.2 mm	+	200
0252611740	CLI C 1-3 GE/SW - MP	● yellow	5 / 4.2 mm	-	200
0252611748	CLI C 1-3 GE/SW . MP	● yellow	5 / 4.2 mm	.	200
0252611742	CLI C 1-3 GE/SW / MP	● yellow	5 / 4.2 mm	/	200
0252611750	CLI C 1-3 GE/SW : MP	● yellow	5 / 4.2 mm	:	200
0252611751	CLI C 1-3 GE/SW = MP	● yellow	5 / 4.2 mm	=	200
0252611752	CLI C 1-3 GE/SW AC MP	● yellow	5 / 4.2 mm	AC	200
0252611746	CLI C 1-3 GE/SW ET MP	● yellow	5 / 4.2 mm	⊥	200
0252611747	CLI C 1-3 GE/SW PET. MP	● yellow	5 / 4.2 mm	⊕	200
0252611697	CLI C 1-3 GE/SW Å MP	● yellow	5 / 4.2 mm	Å	200
0252611699	CLI C 1-3 GE/SW Ä MP	● yellow	5 / 4.2 mm	Ä	200
0252611695	CLI C 1-3 GE/SW Ö MP	● yellow	5 / 4.2 mm	Ö	200
0252611741	CLI C 1-3 BL/WS - MP	● blue	5 / 4.2 mm	-	200
0252611664	CLI C 1-3 BL/WS N MP	● blue	5 / 4.2 mm	N	200
0252611737	CLI C 1-3 RT/WS + MP	● red	5 / 4.2 mm	+	200



## CLI C 1-3 International colour code (CD)

## Technical data

Material	Fire class acc. to UL 94	Temperature range	Wire O.D.	Version
PVC, soft, without Cadmium	V-0	-30 °C...80 °C	2.5 - 5 mm	CD

## Ordering data

Order No.	Type	Colour	Depth / Width	Printing	Qty.
1568251503	CLI C 1-3 SW/WS 0 CD	● black	5 / 4.2 mm	0	500
1568251506	CLI C 1-3 BR/WS 1 CD	● brown	5 / 4.2 mm	1	500
1568251509	CLI C 1-3 RT/WS 2 CD	● red	5 / 4.2 mm	2	500
1568251512	CLI C 1-3 OR/SW 3 CD	● orange	5 / 4.2 mm	3	500
1568251514	CLI C 1-3 GE/SW 4 CD	● yellow	5 / 4.2 mm	4	500
1568251518	CLI C 1-3 GN/WS 5 CD	● green	5 / 4.2 mm	5	500
1568251521	CLI C 1-3 BL/WS 6 CD	● blue	5 / 4.2 mm	6	500
1568251524	CLI C 1-3 VI/WS 7 CD	● violet	5 / 4.2 mm	7	500
1568251527	CLI C 1-3 GR/SW 8 CD	● grey	5 / 4.2 mm	8	500
1568251530	CLI C 1-3 WS/SW 9 CD	○ white	5 / 4.2 mm	9	500



## CLI C 1-3 Numeric sequence (CD)

## Technical data

Material	Fire class acc. to UL 94	Temperature range	Wire O.D.	Version
PVC, soft, without Cadmium	V-0	-30 °C...80 °C	2.5 - 5 mm	CD

## Ordering data

Order No.	Type	Colour	Depth / Width	Printing	Qty.
1568251502	CLI C 1-3 GE/SW 0 CD	● yellow	5 / 4.2 mm	0	500
1568251000	CLI C 1-3 WS/SW 0 CD	○ white	5 / 4.2 mm	0	500
1568251505	CLI C 1-3 GE/SW 1 CD	● yellow	5 / 4.2 mm	1	500
1568250001	CLI C 1-3 WS/SW 1 CD	○ white	5 / 4.2 mm	1	500
1568251508	CLI C 1-3 GE/SW 2 CD	● yellow	5 / 4.2 mm	2	500
1568250002	CLI C 1-3 WS/SW 2 CD	○ white	5 / 4.2 mm	2	500
1568251511	CLI C 1-3 GE/SW 3 CD	● yellow	5 / 4.2 mm	3	500
1568250003	CLI C 1-3 WS/SW 3 CD	○ white	5 / 4.2 mm	3	500
1568251514	CLI C 1-3 GE/SW 4 CD	● yellow	5 / 4.2 mm	4	500
1568250004	CLI C 1-3 WS/SW 4 CD	○ white	5 / 4.2 mm	4	500
1568251517	CLI C 1-3 GE/SW 5 CD	● yellow	5 / 4.2 mm	5	500
1568250005	CLI C 1-3 WS/SW 5 CD	○ white	5 / 4.2 mm	5	500
1568251520	CLI C 1-3 GE/SW 6 CD	● yellow	5 / 4.2 mm	6	500
1568250006	CLI C 1-3 WS/SW 6 CD	○ white	5 / 4.2 mm	6	500
1568251523	CLI C 1-3 GE/SW 7 CD	● yellow	5 / 4.2 mm	7	500
1568250007	CLI C 1-3 WS/SW 7 CD	○ white	5 / 4.2 mm	7	500
1568251526	CLI C 1-3 GE/SW 8 CD	● yellow	5 / 4.2 mm	8	500
1568250008	CLI C 1-3 WS/SW 8 CD	○ white	5 / 4.2 mm	8	500
1568251529	CLI C 1-3 GE/SW 9 CD	● yellow	5 / 4.2 mm	9	500
1568251530	CLI C 1-3 WS/SW 9 CD	○ white	5 / 4.2 mm	9	500



## CLI C 1-3 Alphabetic (CD)

## Technical data

Material	Fire class acc. to UL 94	Temperature range	Wire O.D.	Version
PVC, soft, without Cadmium	V-0	-30 °C...80 °C	2.5 - 5 mm	CD

## Ordering data

Order No.	Type	Colour	Depth / Width	Printing	Qty.
1568251637	CLI C 1-3 GE/SW A CD	● yellow	5 / 4.2 mm	A	500
1568251021	CLI C 1-3 WS/SW A CD	○ white	5 / 4.2 mm	A	500
1568251639	CLI C 1-3 GE/SW B CD	● yellow	5 / 4.2 mm	B	500
1568251022	CLI C 1-3 WS/SW B CD	○ white	5 / 4.2 mm	B	500
1568251641	CLI C 1-3 GE/SW C CD	● yellow	5 / 4.2 mm	C	500
1568251023	CLI C 1-3 WS/SW C CD	○ white	5 / 4.2 mm	C	500
1568251643	CLI C 1-3 GE/SW D CD	● yellow	5 / 4.2 mm	D	500
1568251024	CLI C 1-3 WS/SW D CD	○ white	5 / 4.2 mm	D	500
1568251645	CLI C 1-3 GE/SW E CD	● yellow	5 / 4.2 mm	E	500
1568251025	CLI C 1-3 WS/SW E CD	○ white	5 / 4.2 mm	E	500
1568251647	CLI C 1-3 GE/SW F CD	● yellow	5 / 4.2 mm	F	500
1568251026	CLI C 1-3 WS/SW F CD	○ white	5 / 4.2 mm	F	500
1568251649	CLI C 1-3 GE/SW G CD	● yellow	5 / 4.2 mm	G	500
1568251027	CLI C 1-3 WS/SW G CD	○ white	5 / 4.2 mm	G	500
1568251651	CLI C 1-3 GE/SW H CD	● yellow	5 / 4.2 mm	H	500
1568251028	CLI C 1-3 WS/SW H CD	○ white	5 / 4.2 mm	H	500
1568251653	CLI C 1-3 GE/SW I CD	● yellow	5 / 4.2 mm	I	500
1568251029	CLI C 1-3 WS/SW I CD	○ white	5 / 4.2 mm	I	500
1568251655	CLI C 1-3 GE/SW J CD	● yellow	5 / 4.2 mm	J	500
1568251030	CLI C 1-3 WS/SW J CD	○ white	5 / 4.2 mm	J	500
1568251657	CLI C 1-3 GE/SW K CD	● yellow	5 / 4.2 mm	K	500
1568251031	CLI C 1-3 WS/SW K CD	○ white	5 / 4.2 mm	K	500
1568251659	CLI C 1-3 GE/SW L CD	● yellow	5 / 4.2 mm	L	500
1568251032	CLI C 1-3 WS/SW L CD	○ white	5 / 4.2 mm	L	500
1568251661	CLI C 1-3 GE/SW M CD	● yellow	5 / 4.2 mm	M	500
1568251033	CLI C 1-3 WS/SW M CD	○ white	5 / 4.2 mm	M	500
1568251663	CLI C 1-3 GE/SW N CD	● yellow	5 / 4.2 mm	N	500
1568251034	CLI C 1-3 WS/SW N CD	○ white	5 / 4.2 mm	N	500
1568251665	CLI C 1-3 GE/SW O CD	● yellow	5 / 4.2 mm	O	500
1568251035	CLI C 1-3 WS/SW O CD	○ white	5 / 4.2 mm	O	500
1568251667	CLI C 1-3 GE/SW P CD	● yellow	5 / 4.2 mm	P	500
1568251036	CLI C 1-3 WS/SW P CD	○ white	5 / 4.2 mm	P	500
1568251669	CLI C 1-3 GE/SW Q CD	● yellow	5 / 4.2 mm	Q	500
1568251037	CLI C 1-3 WS/SW Q CD	○ white	5 / 4.2 mm	Q	500
1568251671	CLI C 1-3 GE/SW R CD	● yellow	5 / 4.2 mm	R	500
1568251038	CLI C 1-3 WS/SW R CD	○ white	5 / 4.2 mm	R	500
1568251673	CLI C 1-3 GE/SW S CD	● yellow	5 / 4.2 mm	S	500
1568251039	CLI C 1-3 WS/SW S CD	○ white	5 / 4.2 mm	S	500
1568251676	CLI C 1-3 GE/SW T CD	● yellow	5 / 4.2 mm	T	500
1568251040	CLI C 1-3 WS/SW T CD	○ white	5 / 4.2 mm	T	500
1568251679	CLI C 1-3 GE/SW U CD	● yellow	5 / 4.2 mm	U	500
1568251041	CLI C 1-3 WS/SW U CD	○ white	5 / 4.2 mm	U	500
1568251681	CLI C 1-3 GE/SW V CD	● yellow	5 / 4.2 mm	V	500
1568251042	CLI C 1-3 WS/SW V CD	○ white	5 / 4.2 mm	V	500
1568251683	CLI C 1-3 GE/SW W CD	● yellow	5 / 4.2 mm	W	500
1568251043	CLI C 1-3 WS/SW W CD	○ white	5 / 4.2 mm	W	500
1568251687	CLI C 1-3 GE/SW X CD	● yellow	5 / 4.2 mm	X	500
1568251054	CLI C 1-3 WS/SW X CD	○ white	5 / 4.2 mm	X	500
1568251696	CLI C 1-3 GE/SW Y CD	● yellow	5 / 4.2 mm	Y	500
1568251045	CLI C 1-3 WS/SW Y CD	○ white	5 / 4.2 mm	Y	500
1568251698	CLI C 1-3 GE/SW Z CD	● yellow	5 / 4.2 mm	Z	500
1568251046	CLI C 1-3 WS/SW Z CD	○ white	5 / 4.2 mm	Z	500



## CLI C 1-3 Special characters (CD)

## Technical data

Material	Fire class acc. to UL 94	Temperature range	Wire O.D.	Version
PVC, soft, without Cadmium	V-0	-30 °C...80 °C	2.5 - 5 mm	CD

## Ordering data

Order No.	Type	Colour	Depth / Width	Printing	Qty.
1568251753	CLI C 1-3 GE/SW * CD	● yellow	5 / 4.2 mm	*	500
1568251738	CLI C 1-3 GE/SW + CD	● yellow	5 / 4.2 mm	+	500
1568251048	CLI C 1-3 WS/SW + CD	○ white	5 / 4.2 mm	+	500
1568251740	CLI C 1-3 GE/SW - CD	● yellow	5 / 4.2 mm	-	500
1568251049	CLI C 1-3 WS/SW - CD	○ white	5 / 4.2 mm	-	500
1568251748	CLI C 1-3 GE/SW . CD	● yellow	5 / 4.2 mm	.	500
1568251047	CLI C 1-3 WS/SW . CD	○ white	5 / 4.2 mm	.	500
1568251742	CLI C 1-3 GE/SW / CD	● yellow	5 / 4.2 mm	/	500
1568251050	CLI C 1-3 WS/SW / CD	○ white	5 / 4.2 mm	/	500
1568251750	CLI C 1-3 GE/SW : CD	● yellow	5 / 4.2 mm	:	500
1568251051	CLI C 1-3 WS/SW : CD	○ white	5 / 4.2 mm	:	500
1568251751	CLI C 1-3 GE/SW = CD	● yellow	5 / 4.2 mm	=	500
1568251052	CLI C 1-3 WS/SW = CD	○ white	5 / 4.2 mm	=	500
1568251752	CLI C 1-3 GE/SW AC CD	● yellow	5 / 4.2 mm	AC	500
1568251746	CLI C 1-3 GE/SW ET CD	● yellow	5 / 4.2 mm	⊥	500
1568251053	CLI C 1-3 WS/SW ET CD	○ white	5 / 4.2 mm	⊥	500
1568251747	CLI C 1-3 GE/SW PET. CD	● yellow	5 / 4.2 mm	⊕	500
1568251058	CLI C 1-3 WS/SW PET. CD	○ white	5 / 4.2 mm	⊕	500
1568251797	CLI C 1-3 GE/SW Å CD	● yellow	5 / 4.2 mm	Å	500
1568251055	CLI C 1-3 WS/SW ? CD	○ white	5 / 4.2 mm	?	500
1568251799	CLI C 1-3 GE/SW Å CD	● yellow	5 / 4.2 mm	Å	500
1568251735	CLI C 1-3 GE/SW Æ CD	● yellow	5 / 4.2 mm	Æ	500
1568251795	CLI C 1-3 GE/SW Ö CD	● yellow	5 / 4.2 mm	Ö	500
1568251057	CLI C 1-3 WS/SW Ö CD	○ white	5 / 4.2 mm	Ö	500
1568251736	CLI C 1-3 GE/SW Ø CD	● yellow	5 / 4.2 mm	Ø	500
1568251741	CLI C 1-3 BL/WS - CD	● blue	5 / 4.2 mm	-	500
1568251664	CLI C 1-3 BL/WS N CD	● blue	5 / 4.2 mm	N	500
1568251737	CLI C 1-3 RT/WS + CD	● red	5 / 4.2 mm	+	500





## CLI C 1-6 Numeric sequence (MultiPack)

## Technical data

Material	Fire class acc. to UL 94	Temperature range	Wire O.D.	Version
PVC, soft, without Cadmium	V-0	-30 °C...80 °C	2.5 - 5 mm	MultiPack

## Ordering data

Order No.	Type	Colour	Depth / Width	Printing	Qty.
0252711522	CLI C 1-6 GE/SW 01 MP	yellow	5 / 4.2 mm	01	100
0252711523	CLI C 1-6 GE/SW 02 MP	yellow	5 / 4.2 mm	02	100
0252711524	CLI C 1-6 GE/SW 03 MP	yellow	5 / 4.2 mm	03	100
0252711525	CLI C 1-6 GE/SW 04 MP	yellow	5 / 4.2 mm	04	100
0252711526	CLI C 1-6 GE/SW 05 MP	yellow	5 / 4.2 mm	05	100
0252711527	CLI C 1-6 GE/SW 06 MP	yellow	5 / 4.2 mm	06	100
0252711528	CLI C 1-6 GE/SW 07 MP	yellow	5 / 4.2 mm	07	100
0252711529	CLI C 1-6 GE/SW 08 MP	yellow	5 / 4.2 mm	08	100
0252711530	CLI C 1-6 GE/SW 09 MP	yellow	5 / 4.2 mm	09	100
0252711531	CLI C 1-6 GE/SW 10 MP	yellow	5 / 4.2 mm	10	100
0252711532	CLI C 1-6 GE/SW 11 MP	yellow	5 / 4.2 mm	11	100
0252711533	CLI C 1-6 GE/SW 12 MP	yellow	5 / 4.2 mm	12	100
0252711534	CLI C 1-6 GE/SW 13 MP	yellow	5 / 4.2 mm	13	100
0252711535	CLI C 1-6 GE/SW 14 MP	yellow	5 / 4.2 mm	14	100
0252711536	CLI C 1-6 GE/SW 15 MP	yellow	5 / 4.2 mm	15	100
0252711537	CLI C 1-6 GE/SW 16 MP	yellow	5 / 4.2 mm	16	100
0252711538	CLI C 1-6 GE/SW 17 MP	yellow	5 / 4.2 mm	17	100
0252711539	CLI C 1-6 GE/SW 18 MP	yellow	5 / 4.2 mm	18	100
0252711540	CLI C 1-6 GE/SW 19 MP	yellow	5 / 4.2 mm	19	100
0252711541	CLI C 1-6 GE/SW 20 MP	yellow	5 / 4.2 mm	20	100
0252711542	CLI C 1-6 GE/SW 21 MP	yellow	5 / 4.2 mm	21	100
0252711543	CLI C 1-6 GE/SW 22 MP	yellow	5 / 4.2 mm	22	100
0252711544	CLI C 1-6 GE/SW 23 MP	yellow	5 / 4.2 mm	23	100
0252711545	CLI C 1-6 GE/SW 24 MP	yellow	5 / 4.2 mm	24	100
0252711546	CLI C 1-6 GE/SW 25 MP	yellow	5 / 4.2 mm	25	100
0252711547	CLI C 1-6 GE/SW 26 MP	yellow	5 / 4.2 mm	26	100
0252711548	CLI C 1-6 GE/SW 27 MP	yellow	5 / 4.2 mm	27	100
0252711549	CLI C 1-6 GE/SW 28 MP	yellow	5 / 4.2 mm	28	100
0252711550	CLI C 1-6 GE/SW 29 MP	yellow	5 / 4.2 mm	29	100
0252711551	CLI C 1-6 GE/SW 30 MP	yellow	5 / 4.2 mm	30	100
0252711552	CLI C 1-6 GE/SW 31 MP	yellow	5 / 4.2 mm	31	100
0252711553	CLI C 1-6 GE/SW 32 MP	yellow	5 / 4.2 mm	32	100
0252711554	CLI C 1-6 GE/SW 33 MP	yellow	5 / 4.2 mm	33	100
0252711555	CLI C 1-6 GE/SW 34 MP	yellow	5 / 4.2 mm	34	100
0252711556	CLI C 1-6 GE/SW 35 MP	yellow	5 / 4.2 mm	35	100
0252711557	CLI C 1-6 GE/SW 36 MP	yellow	5 / 4.2 mm	36	100
0252711558	CLI C 1-6 GE/SW 37 MP	yellow	5 / 4.2 mm	37	100
0252711559	CLI C 1-6 GE/SW 38 MP	yellow	5 / 4.2 mm	38	100
0252711560	CLI C 1-6 GE/SW 39 MP	yellow	5 / 4.2 mm	39	100
0252711561	CLI C 1-6 GE/SW 40 MP	yellow	5 / 4.2 mm	40	100
0252711562	CLI C 1-6 GE/SW 41 MP	yellow	5 / 4.2 mm	41	100
0252711563	CLI C 1-6 GE/SW 42 MP	yellow	5 / 4.2 mm	42	100
0252711564	CLI C 1-6 GE/SW 43 MP	yellow	5 / 4.2 mm	43	100
0252711565	CLI C 1-6 GE/SW 44 MP	yellow	5 / 4.2 mm	44	100
0252711566	CLI C 1-6 GE/SW 45 MP	yellow	5 / 4.2 mm	45	100
0252711567	CLI C 1-6 GE/SW 46 MP	yellow	5 / 4.2 mm	46	100
0252711568	CLI C 1-6 GE/SW 47 MP	yellow	5 / 4.2 mm	47	100
0252711569	CLI C 1-6 GE/SW 48 MP	yellow	5 / 4.2 mm	48	100
0252711570	CLI C 1-6 GE/SW 49 MP	yellow	5 / 4.2 mm	49	100
0252711571	CLI C 1-6 GE/SW 50 MP	yellow	5 / 4.2 mm	50	100
0252711572	CLI C 1-6 GE/SW 51 MP	yellow	5 / 4.2 mm	51	100
0252711573	CLI C 1-6 GE/SW 52 MP	yellow	5 / 4.2 mm	52	100
0252711574	CLI C 1-6 GE/SW 53 MP	yellow	5 / 4.2 mm	53	100
0252711575	CLI C 1-6 GE/SW 54 MP	yellow	5 / 4.2 mm	54	100
0252711576	CLI C 1-6 GE/SW 55 MP	yellow	5 / 4.2 mm	55	100
0252711577	CLI C 1-6 GE/SW 56 MP	yellow	5 / 4.2 mm	56	100
0252711578	CLI C 1-6 GE/SW 57 MP	yellow	5 / 4.2 mm	57	100
0252711579	CLI C 1-6 GE/SW 58 MP	yellow	5 / 4.2 mm	58	100
0252711580	CLI C 1-6 GE/SW 59 MP	yellow	5 / 4.2 mm	59	100
0252711581	CLI C 1-6 GE/SW 60 MP	yellow	5 / 4.2 mm	60	100



## CLI C 1-6 Numeric sequence (MultiPack)

## Technical data

Material	Fire class acc. to UL 94	Temperature range	Wire O.D.	Version
PVC, soft, without Cadmium	V-0	-30 °C...80 °C	2.5 - 5 mm	MultiPack

## Ordering data

Order No.	Type	Colour	Depth / Width	Printing	Qty.
0252711582	CLI C 1-6 GE/SW 61 MP	● yellow	5 / 4.2 mm	61	100
0252711583	CLI C 1-6 GE/SW 62 MP	● yellow	5 / 4.2 mm	62	100
0252711584	CLI C 1-6 GE/SW 63 MP	● yellow	5 / 4.2 mm	63	100
0252711585	CLI C 1-6 GE/SW 64 MP	● yellow	5 / 4.2 mm	64	100
0252711586	CLI C 1-6 GE/SW 65 MP	● yellow	5 / 4.2 mm	65	100
0252711587	CLI C 1-6 GE/SW 66 MP	● yellow	5 / 4.2 mm	66	100
0252711588	CLI C 1-6 GE/SW 67 MP	● yellow	5 / 4.2 mm	67	100
0252711589	CLI C 1-6 GE/SW 68 MP	● yellow	5 / 4.2 mm	68	100
0252711590	CLI C 1-6 GE/SW 69 MP	● yellow	5 / 4.2 mm	69	100
0252711591	CLI C 1-6 GE/SW 70 MP	● yellow	5 / 4.2 mm	70	100
0252711592	CLI C 1-6 GE/SW 71 MP	● yellow	5 / 4.2 mm	71	100
0252711593	CLI C 1-6 GE/SW 72 MP	● yellow	5 / 4.2 mm	72	100
0252711594	CLI C 1-6 GE/SW 73 MP	● yellow	5 / 4.2 mm	73	100
0252711595	CLI C 1-6 GE/SW 74 MP	● yellow	5 / 4.2 mm	74	100
0252711596	CLI C 1-6 GE/SW 75 MP	● yellow	5 / 4.2 mm	75	100
0252711597	CLI C 1-6 GE/SW 76 MP	● yellow	5 / 4.2 mm	76	100
0252711598	CLI C 1-6 GE/SW 77 MP	● yellow	5 / 4.2 mm	77	100
0252711599	CLI C 1-6 GE/SW 78 MP	● yellow	5 / 4.2 mm	78	100
0252711600	CLI C 1-6 GE/SW 79 MP	● yellow	5 / 4.2 mm	79	100
0252711601	CLI C 1-6 GE/SW 80 MP	● yellow	5 / 4.2 mm	80	100
0252711602	CLI C 1-6 GE/SW 81 MP	● yellow	5 / 4.2 mm	81	100
0252711603	CLI C 1-6 GE/SW 82 MP	● yellow	5 / 4.2 mm	82	100
0252711604	CLI C 1-6 GE/SW 83 MP	● yellow	5 / 4.2 mm	83	100
0252711605	CLI C 1-6 GE/SW 84 MP	● yellow	5 / 4.2 mm	84	100
0252711606	CLI C 1-6 GE/SW 85 MP	● yellow	5 / 4.2 mm	85	100
0252711607	CLI C 1-6 GE/SW 86 MP	● yellow	5 / 4.2 mm	86	100
0252711608	CLI C 1-6 GE/SW 87 MP	● yellow	5 / 4.2 mm	87	100
0252711609	CLI C 1-6 GE/SW 88 MP	● yellow	5 / 4.2 mm	88	100
0252711610	CLI C 1-6 GE/SW 89 MP	● yellow	5 / 4.2 mm	89	100
0252711611	CLI C 1-6 GE/SW 90 MP	● yellow	5 / 4.2 mm	90	100
0252711612	CLI C 1-6 GE/SW 91 MP	● yellow	5 / 4.2 mm	91	100
0252711613	CLI C 1-6 GE/SW 92 MP	● yellow	5 / 4.2 mm	92	100
0252711614	CLI C 1-6 GE/SW 93 MP	● yellow	5 / 4.2 mm	93	100
0252711615	CLI C 1-6 GE/SW 94 MP	● yellow	5 / 4.2 mm	94	100
0252711616	CLI C 1-6 GE/SW 95 MP	● yellow	5 / 4.2 mm	95	100
0252711617	CLI C 1-6 GE/SW 96 MP	● yellow	5 / 4.2 mm	96	100
0252711618	CLI C 1-6 GE/SW 97 MP	● yellow	5 / 4.2 mm	97	100
0252711619	CLI C 1-6 GE/SW 98 MP	● yellow	5 / 4.2 mm	98	100
0252711620	CLI C 1-6 GE/SW 99 MP	● yellow	5 / 4.2 mm	99	100



## CLI C 1-6 Special characters (MultiPack)

## Technical data

Material	Fire class acc. to UL 94	Temperature range	Wire O.D.	Version
PVC, soft, without Cadmium	V-0	-30 °C...80 °C	2.5 - 5 mm	MultiPack

## Ordering data

Order No.	Type	Colour	Depth / Width	Printing	Qty.
0252711726	CLI C 1-6 GE/SW A1 MP	● yellow	5 / 4.2 mm	A1	100
0252711727	CLI C 1-6 GE/SW A2 MP	● yellow	5 / 4.2 mm	A2	100
0252711728	CLI C 1-6 GE/SW L1 MP	● yellow	5 / 4.2 mm	L1	100
0252711729	CLI C 1-6 GE/SW L2 MP	● yellow	5 / 4.2 mm	L2	100
0252711730	CLI C 1-6 GE/SW L3 MP	● yellow	5 / 4.2 mm	L3	100
0252711733	CLI C 1-6 GE/SW PE MP	● yellow	5 / 4.2 mm	PE	100



## CLI C 1-9 Special characters (MultiPack)

## Technical data

Material	Fire class acc. to UL 94	Temperature range	Wire O.D.	Version
PVC, soft, without Cadmium	V-0	-30 °C...80 °C	2.5 - 5 mm	MultiPack

## Ordering data

Order No.	Type	Colour	Depth / Width	Printing	Qty.
0252711734	CLI C 1-9 GE/SW PEN MP	● yellow	5 / 4.2 mm	PEN	100



## CLI C 1-6 Numeric sequence (CD)

## Technical data

Material	Fire class acc. to UL 94	Temperature range	Wire O.D.	Version
PVC, soft, without Cadmium	V-0	-30 °C...80 °C	2.5 - 5 mm	CD

## Ordering data

Order No.	Type	Colour	Depth / Width	Printing	Qty.
1868811522	CLI C 1-6 GE/SW 01 CD	● yellow	5 / 4.2 mm	01	250
1868811523	CLI C 1-6 GE/SW 02 CD	● yellow	5 / 4.2 mm	02	250
1868811524	CLI C 1-6 GE/SW 03 CD	● yellow	5 / 4.2 mm	03	250
1868811525	CLI C 1-6 GE/SW 04 CD	● yellow	5 / 4.2 mm	04	250
1868811526	CLI C 1-6 GE/SW 05 CD	● yellow	5 / 4.2 mm	05	250
1868811527	CLI C 1-6 GE/SW 06 CD	● yellow	5 / 4.2 mm	06	250
1868811528	CLI C 1-6 GE/SW 07 CD	● yellow	5 / 4.2 mm	07	250
1868811529	CLI C 1-6 GE/SW 08 CD	● yellow	5 / 4.2 mm	08	250
1868811530	CLI C 1-6 GE/SW 09 CD	● yellow	5 / 4.2 mm	09	250
1868811531	CLI C 1-6 GE/SW 10 CD	● yellow	5 / 4.2 mm	10	250
1868811532	CLI C 1-6 GE/SW 11 CD	● yellow	5 / 4.2 mm	11	250
1868811533	CLI C 1-6 GE/SW 12 CD	● yellow	5 / 4.2 mm	12	250
1868811534	CLI C 1-6 GE/SW 13 CD	● yellow	5 / 4.2 mm	13	250
1868811535	CLI C 1-6 GE/SW 14 CD	● yellow	5 / 4.2 mm	14	250
1868811536	CLI C 1-6 GE/SW 15 CD	● yellow	5 / 4.2 mm	15	250
1868811537	CLI C 1-6 GE/SW 16 CD	● yellow	5 / 4.2 mm	16	250
1868811538	CLI C 1-6 GE/SW 17 CD	● yellow	5 / 4.2 mm	17	250
1868811539	CLI C 1-6 GE/SW 18 CD	● yellow	5 / 4.2 mm	18	250
1868811540	CLI C 1-6 GE/SW 19 CD	● yellow	5 / 4.2 mm	19	250
1868811541	CLI C 1-6 GE/SW 20 CD	● yellow	5 / 4.2 mm	20	250
1868811542	CLI C 1-6 GE/SW 21 CD	● yellow	5 / 4.2 mm	21	250
1868811543	CLI C 1-6 GE/SW 22 CD	● yellow	5 / 4.2 mm	22	250
1868811544	CLI C 1-6 GE/SW 23 CD	● yellow	5 / 4.2 mm	23	250
1868811545	CLI C 1-6 GE/SW 24 CD	● yellow	5 / 4.2 mm	24	250
1868811546	CLI C 1-6 GE/SW 25 CD	● yellow	5 / 4.2 mm	25	250
1868811547	CLI C 1-6 GE/SW 26 CD	● yellow	5 / 4.2 mm	26	250
1868811548	CLI C 1-6 GE/SW 27 CD	● yellow	5 / 4.2 mm	27	250
1868811549	CLI C 1-6 GE/SW 28 CD	● yellow	5 / 4.2 mm	28	250
1868811550	CLI C 1-6 GE/SW 29 CD	● yellow	5 / 4.2 mm	29	250
1868811551	CLI C 1-6 GE/SW 30 CD	● yellow	5 / 4.2 mm	30	250
1868811552	CLI C 1-6 GE/SW 31 CD	● yellow	5 / 4.2 mm	31	250
1868811553	CLI C 1-6 GE/SW 32 CD	● yellow	5 / 4.2 mm	32	250
1868811554	CLI C 1-6 GE/SW 33 CD	● yellow	5 / 4.2 mm	33	250
1868811555	CLI C 1-6 GE/SW 34 CD	● yellow	5 / 4.2 mm	34	250
1868811556	CLI C 1-6 GE/SW 35 CD	● yellow	5 / 4.2 mm	35	250
1868811557	CLI C 1-6 GE/SW 36 CD	● yellow	5 / 4.2 mm	36	250
1868811558	CLI C 1-6 GE/SW 37 CD	● yellow	5 / 4.2 mm	37	250
1868811559	CLI C 1-6 GE/SW 38 CD	● yellow	5 / 4.2 mm	38	250
1868811560	CLI C 1-6 GE/SW 39 CD	● yellow	5 / 4.2 mm	39	250
1868811561	CLI C 1-6 GE/SW 40 CD	● yellow	5 / 4.2 mm	40	250
1868811562	CLI C 1-6 GE/SW 41 CD	● yellow	5 / 4.2 mm	41	250
1868811563	CLI C 1-6 GE/SW 42 CD	● yellow	5 / 4.2 mm	42	250
1868811564	CLI C 1-6 GE/SW 43 CD	● yellow	5 / 4.2 mm	43	250
1868811565	CLI C 1-6 GE/SW 44 CD	● yellow	5 / 4.2 mm	44	250
1868811566	CLI C 1-6 GE/SW 45 CD	● yellow	5 / 4.2 mm	45	250
1868811567	CLI C 1-6 GE/SW 46 CD	● yellow	5 / 4.2 mm	46	250
1868811568	CLI C 1-6 GE/SW 47 CD	● yellow	5 / 4.2 mm	47	250
1868811569	CLI C 1-6 GE/SW 48 CD	● yellow	5 / 4.2 mm	48	250
1868811570	CLI C 1-6 GE/SW 49 CD	● yellow	5 / 4.2 mm	49	250
1868811571	CLI C 1-6 GE/SW 50 CD	● yellow	5 / 4.2 mm	50	250



CLI C 1-6 Numeric sequence (CD)

Technical data

Material	Fire class acc. to UL 94	Temperature range	Wire O.D.	Version
PVC, soft, without Cadmium	V-0	-30 °C...80 °C	2.5 - 5 mm	CD

Ordering data

Order No.	Type	Colour	Depth / Width	Printing	Qty.
1868811572	CLI C 1-6 GE/SW 51 CD	yellow	5 / 4.2 mm	51	250
1868811573	CLI C 1-6 GE/SW 52 CD	yellow	5 / 4.2 mm	52	250
1868811574	CLI C 1-6 GE/SW 53 CD	yellow	5 / 4.2 mm	53	250
1868811575	CLI C 1-6 GE/SW 54 CD	yellow	5 / 4.2 mm	54	250
1868811576	CLI C 1-6 GE/SW 55 CD	yellow	5 / 4.2 mm	55	250
1868811577	CLI C 1-6 GE/SW 56 CD	yellow	5 / 4.2 mm	56	250
1868811578	CLI C 1-6 GE/SW 57 CD	yellow	5 / 4.2 mm	57	250
1868811579	CLI C 1-6 GE/SW 58 CD	yellow	5 / 4.2 mm	58	250
1868811580	CLI C 1-6 GE/SW 59 CD	yellow	5 / 4.2 mm	59	250
1868811581	CLI C 1-6 GE/SW 60 CD	yellow	5 / 4.2 mm	60	250
1868811582	CLI C 1-6 GE/SW 61 CD	yellow	5 / 4.2 mm	61	250
1868811583	CLI C 1-6 GE/SW 62 CD	yellow	5 / 4.2 mm	62	250
1868811584	CLI C 1-6 GE/SW 63 CD	yellow	5 / 4.2 mm	63	250
1868811585	CLI C 1-6 GE/SW 64 CD	yellow	5 / 4.2 mm	64	250
1868811586	CLI C 1-6 GE/SW 65 CD	yellow	5 / 4.2 mm	65	250
1868811587	CLI C 1-6 GE/SW 66 CD	yellow	5 / 4.2 mm	66	250
1868811588	CLI C 1-6 GE/SW 67 CD	yellow	5 / 4.2 mm	67	250
1868811589	CLI C 1-6 GE/SW 68 CD	yellow	5 / 4.2 mm	68	250
1868811590	CLI C 1-6 GE/SW 69 CD	yellow	5 / 4.2 mm	69	250
1868811591	CLI C 1-6 GE/SW 70 CD	yellow	5 / 4.2 mm	70	250
1868811592	CLI C 1-6 GE/SW 71 CD	yellow	5 / 4.2 mm	71	250
1868811593	CLI C 1-6 GE/SW 72 CD	yellow	5 / 4.2 mm	72	250
1868811594	CLI C 1-6 GE/SW 73 CD	yellow	5 / 4.2 mm	73	250
1868811595	CLI C 1-6 GE/SW 74 CD	yellow	5 / 4.2 mm	74	250
1868811596	CLI C 1-6 GE/SW 75 CD	yellow	5 / 4.2 mm	75	250
1868811597	CLI C 1-6 GE/SW 76 CD	yellow	5 / 4.2 mm	76	250
1868811598	CLI C 1-6 GE/SW 77 CD	yellow	5 / 4.2 mm	77	250
1868811599	CLI C 1-6 GE/SW 78 CD	yellow	5 / 4.2 mm	78	250
1868811600	CLI C 1-6 GE/SW 79 CD	yellow	5 / 4.2 mm	79	250
1868811601	CLI C 1-6 GE/SW 80 CD	yellow	5 / 4.2 mm	80	250
1868811602	CLI C 1-6 GE/SW 81 CD	yellow	5 / 4.2 mm	81	250
1868811603	CLI C 1-6 GE/SW 82 CD	yellow	5 / 4.2 mm	82	250
1868811604	CLI C 1-6 GE/SW 83 CD	yellow	5 / 4.2 mm	83	250
1868811605	CLI C 1-6 GE/SW 84 CD	yellow	5 / 4.2 mm	84	250
1868811606	CLI C 1-6 GE/SW 85 CD	yellow	5 / 4.2 mm	85	250
1868811607	CLI C 1-6 GE/SW 86 CD	yellow	5 / 4.2 mm	86	250
1868811608	CLI C 1-6 GE/SW 87 CD	yellow	5 / 4.2 mm	87	250
1868811609	CLI C 1-6 GE/SW 88 CD	yellow	5 / 4.2 mm	88	250
1868811610	CLI C 1-6 GE/SW 89 CD	yellow	5 / 4.2 mm	89	250
1868811611	CLI C 1-6 GE/SW 90 CD	yellow	5 / 4.2 mm	90	250
1868811612	CLI C 1-6 GE/SW 91 CD	yellow	5 / 4.2 mm	91	250
1868811613	CLI C 1-6 GE/SW 92 CD	yellow	5 / 4.2 mm	92	250
1868811614	CLI C 1-6 GE/SW 93 CD	yellow	5 / 4.2 mm	93	250
1868811615	CLI C 1-6 GE/SW 94 CD	yellow	5 / 4.2 mm	94	250
1868811616	CLI C 1-6 GE/SW 95 CD	yellow	5 / 4.2 mm	95	250
1868811617	CLI C 1-6 GE/SW 96 CD	yellow	5 / 4.2 mm	96	250
1868811618	CLI C 1-6 GE/SW 97 CD	yellow	5 / 4.2 mm	97	250
1868811619	CLI C 1-6 GE/SW 98 CD	yellow	5 / 4.2 mm	98	250
1868811620	CLI C 1-6 GE/SW 99 CD	yellow	5 / 4.2 mm	99	250



## CLI C 1-6 Special characters (CD)

## Technical data

Material	Fire class acc. to UL 94	Temperature range	Wire O.D.	Version
PVC, soft, without Cadmium	V-0	-30 °C...80 °C	2.5 - 5 mm	CD

## Ordering data

Order No.	Type	Colour	Depth / Width	Printing	Qty.
1868811726	CLI C 1-6 GE/SW A1 CD	● yellow	5 / 4.2 mm	A1	250
1868811727	CLI C 1-6 GE/SW A2 CD	● yellow	5 / 4.2 mm	A2	250
1868811739	CLI C 1-6 GE/SW I1 CD	● yellow	5 / 4.2 mm	I1	250
1868811740	CLI C 1-6 GE/SW I2 CD	● yellow	5 / 4.2 mm	I2	250
1868811741	CLI C 1-6 GE/SW IC CD	● yellow	5 / 4.2 mm	IC	250
1868811728	CLI C 1-6 GE/SW L1 CD	● yellow	5 / 4.2 mm	L1	250
1868811729	CLI C 1-6 GE/SW L2 CD	● yellow	5 / 4.2 mm	L2	250
1868811730	CLI C 1-6 GE/SW L3 CD	● yellow	5 / 4.2 mm	L3	250
1868811731	CLI C 1-6 GE/SW MP CD	● yellow	5 / 4.2 mm	MP	250
1868811733	CLI C 1-6 GE/SW PE CD	● yellow	5 / 4.2 mm	PE	250
1868811735	CLI C 1-6 GE/SW U1 CD	● yellow	5 / 4.2 mm	U1	250
1868811736	CLI C 1-6 GE/SW U2 CD	● yellow	5 / 4.2 mm	U2	250
1868811737	CLI C 1-6 GE/SW U3 CD	● yellow	5 / 4.2 mm	U3	250
1868811738	CLI C 1-6 GE/SW UN CD	● yellow	5 / 4.2 mm	UN	250
1868811150	CLI C 1-6 GE/SW X1 CD	● yellow	5 / 4.2 mm	X1	250
1868811151	CLI C 1-6 GE/SW X2 CD	● yellow	5 / 4.2 mm	X2	250



## CLI C 1-9 Special characters (CD)

## Technical data

Material	Fire class acc. to UL 94	Temperature range	Wire O.D.	Version
PVC, soft, without Cadmium	V-0	-30 °C...80 °C	2.5 - 5 mm	CD

## Ordering data

Order No.	Type	Colour	Depth / Width	Printing	Qty.
1868811734	CLI C 1-9 GE/SW PEN CD	● yellow	5 / 4.2 mm	PEN	125



## CLI C 2-4 International colour code (MultiPack)

## Technical data

Material	Fire class acc. to UL 94	Temperature range	Wire O.D.	Version
PVC, soft, without Cadmium	V-0	-30 °C...80 °C	4 - 10 mm	MultiPack

## Ordering data

Order No.	Type	Colour	Depth / Width	Printing	Qty.
0251311503	CLI C 2-4 SW/WS 0 MP	● black	8 / 7 mm	0	100
0251311506	CLI C 2-4 BR/WS 1 MP	● brown	8 / 7 mm	1	100
0251311509	CLI C 2-4 RT/WS 2 MP	● red	8 / 7 mm	2	100
0251311512	CLI C 2-4 OR/WS 3 MP	● orange	8 / 7 mm	3	100
0251311514	CLI C 2-4 GE/WS 4 MP	● yellow	8 / 7 mm	4	100
0251311518	CLI C 2-4 GN/WS 5 MP	● green	8 / 7 mm	5	100
0251311521	CLI C 2-4 BL/WS 6 MP	● blue	8 / 7 mm	6	100
0251311524	CLI C 2-4 VI/WS 7 MP	● violet	8 / 7 mm	7	100
0251311527	CLI C 2-4 GR/WS 8 MP	● grey	8 / 7 mm	8	100
0251310009	CLI C 2-4 WS/SW 9 MP	○ white	8 / 7 mm	9	100



## CLI C 2-4 Numeric sequence (MultiPack)

## Technical data

Material	Fire class acc. to UL 94	Temperature range	Wire O.D.	Version
PVC, soft, without Cadmium	V-0	-30 °C..80 °C	4 - 10 mm	MultiPack

## Ordering data

Order No.	Type	Colour	Depth / Width	Printing	Qty.
0251311502	CLI C 2-4 GE/SW 0 MP	● yellow	8 / 7 mm	0	100
0251311000	CLI C 2-4 WS/SW 0 MP	○ white	8 / 7 mm	0	100
0251311505	CLI C 2-4 GE/SW 1 MP	● yellow	8 / 7 mm	1	100
0251310001	CLI C 2-4 WS/SW 1 MP	○ white	8 / 7 mm	1	100
0251311508	CLI C 2-4 GE/SW 2 MP	● yellow	8 / 7 mm	2	100
0251310002	CLI C 2-4 WS/SW 2 MP	○ white	8 / 7 mm	2	100
0251311511	CLI C 2-4 GE/SW 3 MP	● yellow	8 / 7 mm	3	100
0251310003	CLI C 2-4 WS/SW 3 MP	○ white	8 / 7 mm	3	100
0251311514	CLI C 2-4 GE/SW 4 MP	● yellow	8 / 7 mm	4	100
0251310004	CLI C 2-4 WS/SW 4 MP	○ white	8 / 7 mm	4	100
0251311517	CLI C 2-4 GE/SW 5 MP	● yellow	8 / 7 mm	5	100
0251310005	CLI C 2-4 WS/SW 5 MP	○ white	8 / 7 mm	5	100
0251311520	CLI C 2-4 GE/SW 6 MP	● yellow	8 / 7 mm	6	100
0251310006	CLI C 2-4 WS/SW 6 MP	○ white	8 / 7 mm	6	100
0251311523	CLI C 2-4 GE/SW 7 MP	● yellow	8 / 7 mm	7	100
0251310007	CLI C 2-4 WS/SW 7 MP	○ white	8 / 7 mm	7	100
0251311526	CLI C 2-4 GE/SW 8 MP	● yellow	8 / 7 mm	8	100
0251310008	CLI C 2-4 WS/SW 8 MP	○ white	8 / 7 mm	8	100
0251311529	CLI C 2-4 GE/SW 9 MP	● yellow	8 / 7 mm	9	100
0251310009	CLI C 2-4 WS/SW 9 MP	○ white	8 / 7 mm	9	100



## CLI C 2-4 Alphabetic (MultiPack)

## Technical data

Material	Fire class acc. to UL 94	Temperature range	Wire O.D.	Version
PVC, soft, without Cadmium	V-0	-30 °C..80 °C	4 - 10 mm	MultiPack

## Ordering data

Order No.	Type	Colour	Depth / Width	Printing	Qty.
0251311637	CLI C 2-4 GE/SW A MP	● yellow	8 / 7 mm	A	100
0251311639	CLI C 2-4 GE/SW B MP	● yellow	8 / 7 mm	B	100
0251311641	CLI C 2-4 GE/SW C MP	● yellow	8 / 7 mm	C	100
0251311643	CLI C 2-4 GE/SW D MP	● yellow	8 / 7 mm	D	100
0251311645	CLI C 2-4 GE/SW E MP	● yellow	8 / 7 mm	E	100
0251311647	CLI C 2-4 GE/SW F MP	● yellow	8 / 7 mm	F	100
0251311649	CLI C 2-4 GE/SW G MP	● yellow	8 / 7 mm	G	100
0251311651	CLI C 2-4 GE/SW H MP	● yellow	8 / 7 mm	H	100
0251311653	CLI C 2-4 GE/SW I MP	● yellow	8 / 7 mm	I	100
0251311655	CLI C 2-4 GE/SW J MP	● yellow	8 / 7 mm	J	100
0251311657	CLI C 2-4 GE/SW K MP	● yellow	8 / 7 mm	K	100
0251311659	CLI C 2-4 GE/SW L MP	● yellow	8 / 7 mm	L	100
0251311661	CLI C 2-4 GE/SW M MP	● yellow	8 / 7 mm	M	100
0251311663	CLI C 2-4 GE/SW N MP	● yellow	8 / 7 mm	N	100
0251311665	CLI C 2-4 GE/SW O MP	● yellow	8 / 7 mm	O	100
0251311667	CLI C 2-4 GE/SW P MP	● yellow	8 / 7 mm	P	100
0251311669	CLI C 2-4 GE/SW Q MP	● yellow	8 / 7 mm	Q	100
0251311671	CLI C 2-4 GE/SW R MP	● yellow	8 / 7 mm	R	100
0251311673	CLI C 2-4 GE/SW S MP	● yellow	8 / 7 mm	S	100
0251311676	CLI C 2-4 GE/SW T MP	● yellow	8 / 7 mm	T	100
0251311679	CLI C 2-4 GE/SW U MP	● yellow	8 / 7 mm	U	100
0251311681	CLI C 2-4 GE/SW V MP	● yellow	8 / 7 mm	V	100
0251311683	CLI C 2-4 GE/SW W MP	● yellow	8 / 7 mm	W	100
0251311687	CLI C 2-4 GE/SW X MP	● yellow	8 / 7 mm	X	100
0251311696	CLI C 2-4 GE/SW Y MP	● yellow	8 / 7 mm	Y	100
0251311698	CLI C 2-4 GE/SW Z MP	● yellow	8 / 7 mm	Z	100



## CLI C 2-4 Special characters (MultiPack)

## Technical data

Material	Fire class acc. to UL 94	Temperature range	Wire O.D.	Version
PVC, soft, without Cadmium	V-0	-30 °C...80 °C	4 - 10 mm	MultiPack

## Ordering data

Order No.	Type	Colour	Depth / Width	Printing	Qty.
0251311738	CLI C 2-4 GE/SW + MP	● yellow	8 / 7 mm	+	100
0251311048	CLI C 2-4 WS/SW + MP	○ white	8 / 7 mm	+	100
0251311740	CLI C 2-4 GE/SW - MP	● yellow	8 / 7 mm	-	100
0251311049	CLI C 2-4 WS/SW - MP	○ white	8 / 7 mm	-	100
0251311748	CLI C 2-4 GE/SW . MP	● yellow	8 / 7 mm	.	100
0251311742	CLI C 2-4 GE/SW / MP	● yellow	8 / 7 mm	/	100
0251311750	CLI C 2-4 GE/SW : MP	● yellow	8 / 7 mm	:	100
0251311751	CLI C 2-4 GE/SW = MP	● yellow	8 / 7 mm	=	100
0251311752	CLI C 2-4 GE/SW AC MP	● yellow	8 / 7 mm	AC	100
0251311746	CLI C 2-4 GE/SW ET MP	● yellow	8 / 7 mm	⊥	100
0251311747	CLI C 2-4 GE/SW PET. MP	● yellow	8 / 7 mm	⊕	100
0251311697	CLI C 2-4 GE/SW Å MP	● yellow	8 / 7 mm	Å	100
0251311699	CLI C 2-4 GE/SW Ä MP	● yellow	8 / 7 mm	Ä	100
0251311735	CLI C 2-4 GE/SW Æ MP	● yellow	8 / 7 mm	Æ	100
0251311695	CLI C 2-4 GE/SW Ö MP	● yellow	8 / 7 mm	Ö	100
0251311736	CLI C 2-4 GE/SW Ø MP	● yellow	8 / 7 mm	Ø	100



## CLI C 2-4 International colour code (CD)

## Technical data

Material	Fire class acc. to UL 94	Temperature range	Wire O.D.	Version
PVC, soft, without Cadmium	V-0	-30 °C...80 °C	4 - 10 mm	CD

## Ordering data

Order No.	Type	Colour	Depth / Width	Printing	Qty.
1568261503	CLI C 2-4 SW/WS 0 CD	● black	8 / 7 mm	0	250
1568261506	CLI C 2-4 BR/WS 1 CD	● brown	8 / 7 mm	1	250
1568261509	CLI C 2-4 RT/WS 2 CD	● red	8 / 7 mm	2	250
1568261512	CLI C 2-4 OR/SW 3 CD	● orange	8 / 7 mm	3	250
1568261514	CLI C 2-4 GE/SW 4 CD	● yellow	8 / 7 mm	4	250
1568261518	CLI C 2-4 GN/WS 5 CD	● green	8 / 7 mm	5	250
1568261521	CLI C 2-4 BL/WS 6 CD	● blue	8 / 7 mm	6	250
1568261524	CLI C 2-4 VI/WS 7 CD	● violet	8 / 7 mm	7	250
1568261527	CLI C 2-4 GR/SW 8 CD	● grey	8 / 7 mm	8	250
1568261530	CLI C 2-4 WS/SW 9 CD	○ white	8 / 7 mm	9	250



## CLI C 2-4 Numeric sequence (CD)

## Technical data

Material	Fire class acc. to UL 94	Temperature range	Wire O.D.	Version
PVC, soft, without Cadmium	V-0	-30 °C...80 °C	4 - 10 mm	CD

## Ordering data

Order No.	Type	Colour	Depth / Width	Printing	Qty.
1568261502	CLI C 2-4 GE/SW 0 CD	● yellow	8 / 7 mm	0	250
1568261505	CLI C 2-4 GE/SW 1 CD	● yellow	8 / 7 mm	1	250
1568261508	CLI C 2-4 GE/SW 2 CD	● yellow	8 / 7 mm	2	250
1568261511	CLI C 2-4 GE/SW 3 CD	● yellow	8 / 7 mm	3	250
1568261514	CLI C 2-4 GE/SW 4 CD	● yellow	8 / 7 mm	4	250
1568261517	CLI C 2-4 GE/SW 5 CD	● yellow	8 / 7 mm	5	250
1568261520	CLI C 2-4 GE/SW 6 CD	● yellow	8 / 7 mm	6	250
1568261523	CLI C 2-4 GE/SW 7 CD	● yellow	8 / 7 mm	7	250
1568261526	CLI C 2-4 GE/SW 8 CD	● yellow	8 / 7 mm	8	250
1568261529	CLI C 2-4 GE/SW 9 CD	● yellow	8 / 7 mm	9	250



### CLI C 2-4 Alphabetic (CD)

#### Technical data

Material	Fire class acc. to UL 94	Temperature range	Wire O.D.	Version
PVC, soft, without Cadmium	V-0	-30 °C...80 °C	4 - 10 mm	CD

#### Ordering data

Order No.	Type	Colour	Depth / Width	Printing	Qty.
1568261637	CLI C 2-4 GE/SW A CD	● yellow	8 / 7 mm	A	250
1568261639	CLI C 2-4 GE/SW B CD	● yellow	8 / 7 mm	B	250
1568261641	CLI C 2-4 GE/SW C CD	● yellow	8 / 7 mm	C	250
1568261643	CLI C 2-4 GE/SW D CD	● yellow	8 / 7 mm	D	250
1568261645	CLI C 2-4 GE/SW E CD	● yellow	8 / 7 mm	E	250
1568261647	CLI C 2-4 GE/SW F CD	● yellow	8 / 7 mm	F	250
1568261649	CLI C 2-4 GE/SW G CD	● yellow	8 / 7 mm	G	250
1568261651	CLI C 2-4 GE/SW H CD	● yellow	8 / 7 mm	H	250
1568261653	CLI C 2-4 GE/SW I CD	● yellow	8 / 7 mm	I	250
1568261655	CLI C 2-4 GE/SW J CD	● yellow	8 / 7 mm	J	250
1568261657	CLI C 2-4 GE/SW K CD	● yellow	8 / 7 mm	K	250
1568261659	CLI C 2-4 GE/SW L CD	● yellow	8 / 7 mm	L	250
1568261661	CLI C 2-4 GE/SW M CD	● yellow	8 / 7 mm	M	250
1568261663	CLI C 2-4 GE/SW N CD	● yellow	8 / 7 mm	N	250
1568261665	CLI C 2-4 GE/SW O CD	● yellow	8 / 7 mm	O	250
1568261667	CLI C 2-4 GE/SW P CD	● yellow	8 / 7 mm	P	250
1568261669	CLI C 2-4 GE/SW Q CD	● yellow	8 / 7 mm	Q	250
1568261671	CLI C 2-4 GE/SW R CD	● yellow	8 / 7 mm	R	250
1568261673	CLI C 2-4 GE/SW S CD	● yellow	8 / 7 mm	S	250
1568261676	CLI C 2-4 GE/SW T CD	● yellow	8 / 7 mm	T	250
1568261679	CLI C 2-4 GE/SW U CD	● yellow	8 / 7 mm	U	250
1568261681	CLI C 2-4 GE/SW V CD	● yellow	8 / 7 mm	V	250
1568261683	CLI C 2-4 GE/SW W CD	● yellow	8 / 7 mm	W	250
1568261687	CLI C 2-4 GE/SW X CD	● yellow	8 / 7 mm	X	250
1568261696	CLI C 2-4 GE/SW Y CD	● yellow	8 / 7 mm	Y	250
1568261698	CLI C 2-4 GE/SW Z CD	● yellow	8 / 7 mm	Z	250



### CLI C 2-4 Special characters (CD)

#### Technical data

Material	Fire class acc. to UL 94	Temperature range	Wire O.D.	Version
PVC, soft, without Cadmium	V-0	-30 °C...80 °C	4 - 10 mm	CD

#### Ordering data

Order No.	Type	Colour	Depth / Width	Printing	Qty.
1568261738	CLI C 2-4 GE/SW + CD	● yellow	8 / 7 mm	+	250
1568261740	CLI C 2-4 GE/SW - CD	● yellow	8 / 7 mm	-	250
1568261748	CLI C 2-4 GE/SW . CD	● yellow	8 / 7 mm	.	250
1568261742	CLI C 2-4 GE/SW / CD	● yellow	8 / 7 mm	/	250
1568261750	CLI C 2-4 GE/SW : CD	● yellow	8 / 7 mm	:	250
1568261751	CLI C 2-4 GE/SW = CD	● yellow	8 / 7 mm	=	250
1568261752	CLI C 2-4 GE/SW AC CD	● yellow	8 / 7 mm	AC	250
1568261746	CLI C 2-4 GE/SW ET CD	● yellow	8 / 7 mm	⊥	250
1568261747	CLI C 2-4 GE/SW PET. CD	● yellow	8 / 7 mm	⊕	250
1568261697	CLI C 2-4 GE/SW Å CD	● yellow	8 / 7 mm	Å	250
1568261699	CLI C 2-4 GE/SW Ä CD	● yellow	8 / 7 mm	Ä	250
1568261735	CLI C 2-4 GE/SW Æ CD	● yellow	8 / 7 mm	Æ	250
1568261695	CLI C 2-4 GE/SW Ö CD	● yellow	8 / 7 mm	Ö	250
1568261736	CLI C 2-4 GE/SW Ø CD	● yellow	8 / 7 mm	Ø	250
1568261741	CLI C 2-4 BL/WS - CD	● blue	8 / 7 mm	-	250
1568261737	CLI C 2-4 RT/WS + CD	● red	8 / 7 mm	+	250





**CLI C 2-6 Special characters (MultiPack)****Technical data**

Material	Fire class acc. to UL 94	Temperature range	Wire O.D.	Version
PVC, soft, without Cadmium	V-0	-30 °C...80 °C	4 - 10 mm	MultiPack

**Ordering data**

Order No.	Type	Colour	Depth / Width	Printing	Qty.
1871891728	CLI C 2-6 GE/SW L1 MP	● yellow	8 / 7 mm	L1	100
1871891729	CLI C 2-6 GE/SW L2 MP	● yellow	8 / 7 mm	L2	100
1871891730	CLI C 2-6 GE/SW L3 MP	● yellow	8 / 7 mm	L3	100

**CLI C 2-6 Special characters (CD)****Technical data**

Material	Fire class acc. to UL 94	Temperature range	Wire O.D.	Version
PVC, soft, without Cadmium	V-0	-30 °C...80 °C	4 - 10 mm	CD

**Ordering data**

Order No.	Type	Colour	Depth / Width	Printing	Qty.
1871901728	CLI C 2-6 GE/SW L1 CD	● yellow	8 / 7 mm	L1	125
1871901729	CLI C 2-6 GE/SW L2 CD	● yellow	8 / 7 mm	L2	125
1871901730	CLI C 2-6 GE/SW L3 CD	● yellow	8 / 7 mm	L3	125
1871901731	CLI C 2-6 GE/SW PE CD	● yellow	8 / 7 mm	PE	125

**CLI C 2-9 Special characters (MultiPack)****Technical data**

Material	Fire class acc. to UL 94	Temperature range	Wire O.D.	Version
PVC, soft, without Cadmium	V-0	-30 °C...80 °C	4 - 10 mm	MultiPack

**Ordering data**

Order No.	Type	Colour	Depth / Width	Printing	Qty.
1872031734	CLI C 2-9 GE/SW PEN MP	● yellow	8 / 7 mm	PEN	100

**CLI C 2-9 Special characters (CD)****Technical data**

Material	Fire class acc. to UL 94	Temperature range	Wire O.D.	Version
PVC, soft, without Cadmium	V-0	-30 °C...80 °C	4 - 10 mm	CD

**Ordering data**

Order No.	Type	Colour	Depth / Width	Printing	Qty.
1871971734	CLI C 2-9 GE/SW PEN CD	● yellow	8 / 7 mm	PEN	125



### CLI C 3-6 Numeric sequence (MultiPack)

#### Technical data

Material	Fire class acc. to UL 94	Temperature range	Wire O.D.	Version
PVC, soft, without Cadmium	V-0	-30 °C...80 °C	8 - 16 mm	MultiPack

#### Ordering data

Order No.	Type	Colour	Depth / Width	Printing	Qty.
0253411502	CLI C 3-6 GE/SW 0 MP	● yellow	17 / 11 mm	0	20
0253411505	CLI C 3-6 GE/SW 1 MP	● yellow	17 / 11 mm	1	20
0253411508	CLI C 3-6 GE/SW 2 MP	● yellow	17 / 11 mm	2	20
0253411511	CLI C 3-6 GE/SW 3 MP	● yellow	17 / 11 mm	3	20
0253411514	CLI C 3-6 GE/SW 4 MP	● yellow	17 / 11 mm	4	20
0253411517	CLI C 3-6 GE/SW 5 MP	● yellow	17 / 11 mm	5	20
0253411520	CLI C 3-6 GE/SW 6 MP	● yellow	17 / 11 mm	6	20
0253411523	CLI C 3-6 GE/SW 7 MP	● yellow	17 / 11 mm	7	20
0253411526	CLI C 3-6 GE/SW 8 MP	● yellow	17 / 11 mm	8	20
0253411529	CLI C 3-6 GE/SW 9 MP	● yellow	17 / 11 mm	9	20



### CLI C 3-6 Alphabetic (MultiPack)

#### Technical data

Material	Fire class acc. to UL 94	Temperature range	Wire O.D.	Version
PVC, soft, without Cadmium	V-0	-30 °C...80 °C	8 - 16 mm	MultiPack

#### Ordering data

Order No.	Type	Colour	Depth / Width	Printing	Qty.
0253411637	CLI C 3-6 GE/SW A MP	● yellow	17 / 11 mm	A	20
0253411639	CLI C 3-6 GE/SW B MP	● yellow	17 / 11 mm	B	20
0253411641	CLI C 3-6 GE/SW C MP	● yellow	17 / 11 mm	C	20
0253411643	CLI C 3-6 GE/SW D MP	● yellow	17 / 11 mm	D	20
0253411645	CLI C 3-6 GE/SW E MP	● yellow	17 / 11 mm	E	20
0253411647	CLI C 3-6 GE/SW F MP	● yellow	17 / 11 mm	F	20
0253411649	CLI C 3-6 GE/SW G MP	● yellow	17 / 11 mm	G	20
0253411651	CLI C 3-6 GE/SW H MP	● yellow	17 / 11 mm	H	20
0253411653	CLI C 3-6 GE/SW I MP	● yellow	17 / 11 mm	I	20
0253411655	CLI C 3-6 GE/SW J MP	● yellow	17 / 11 mm	J	20
0253411657	CLI C 3-6 GE/SW K MP	● yellow	17 / 11 mm	K	20
0253411659	CLI C 3-6 GE/SW L MP	● yellow	17 / 11 mm	L	20
0253411661	CLI C 3-6 GE/SW M MP	● yellow	17 / 11 mm	M	20
0253411663	CLI C 3-6 GE/SW N MP	● yellow	17 / 11 mm	N	20
0253411665	CLI C 3-6 GE/SW O MP	● yellow	17 / 11 mm	O	20
0253411667	CLI C 3-6 GE/SW P MP	● yellow	17 / 11 mm	P	20
0253411669	CLI C 3-6 GE/SW Q MP	● yellow	17 / 11 mm	Q	20
0253411671	CLI C 3-6 GE/SW R MP	● yellow	17 / 11 mm	R	20
0253411673	CLI C 3-6 GE/SW S MP	● yellow	17 / 11 mm	S	20
0253411676	CLI C 3-6 GE/SW T MP	● yellow	17 / 11 mm	T	20
0253411679	CLI C 3-6 GE/SW U MP	● yellow	17 / 11 mm	U	20
0253411681	CLI C 3-6 GE/SW V MP	● yellow	17 / 11 mm	V	20
0253411683	CLI C 3-6 GE/SW W MP	● yellow	17 / 11 mm	W	20
0253411687	CLI C 3-6 GE/SW X MP	● yellow	17 / 11 mm	X	20
0253411696	CLI C 3-6 GE/SW Y MP	● yellow	17 / 11 mm	Y	20
0253411698	CLI C 3-6 GE/SW Z MP	● yellow	17 / 11 mm	Z	20



## CLI C 3-6 Special characters (MultiPack)

## Technical data

Material	Fire class acc. to UL 94	Temperature range	Wire O.D.	Version
PVC, soft, without Cadmium	V-0	-30 °C...80 °C	8 - 16 mm	MultiPack

## Ordering data

Order No.	Type	Colour	Depth / Width	Printing	Qty.
0253411742	CLI C 3-6 GE/SW / MP	● yellow	17 / 11 mm	/	20
0253411738	CLI C 3-6 GE/SW + MP	● yellow	17 / 11 mm	+	20
0253411740	CLI C 3-6 GE/SW - MP	● yellow	17 / 11 mm	-	20
0253411748	CLI C 3-6 GE/SW . MP	● yellow	17 / 11 mm	.	20
0253411750	CLI C 3-6 GE/SW : MP	● yellow	17 / 11 mm	:	20
0253411751	CLI C 3-6 GE/SW = MP	● yellow	17 / 11 mm	=	20
0253411752	CLI C 3-6 GE/SW AC MP	● yellow	17 / 11 mm	AC	20
0253411746	CLI C 3-6 GE/SW ET MP	● yellow	17 / 11 mm	⊥	20
0253411697	CLI C 3-6 GE/SW Å MP	● yellow	17 / 11 mm	Å	20
0253411699	CLI C 3-6 GE/SW Ä MP	● yellow	17 / 11 mm	Ä	20
0253411695	CLI C 3-6 GE/SW Ö MP	● yellow	17 / 11 mm	Ö	20
0253411741	CLI C 3-6 BL/WS - MP	● blue	17 / 11 mm	-	20

## CLI C 3-9 Special characters (MultiPack)

## Technical data

Material	Fire class acc. to UL 94	Temperature range	Wire O.D.	Version
PVC, soft, without Cadmium	V-0	-30 °C...80 °C	8 - 16 mm	MultiPack

## Ordering data

Order No.	Type	Colour	Depth / Width	Printing	Qty.
0253511726	CLI C 3-9 GE/SW A1 MP	● yellow	17 / 11 mm	A1	20
0253511727	CLI C 3-9 GE/SW A2 MP	● yellow	17 / 11 mm	A2	20
0253511728	CLI C 3-9 GE/SW L1 MP	● yellow	17 / 11 mm	L1	20
0253511729	CLI C 3-9 GE/SW L2 MP	● yellow	17 / 11 mm	L2	20
0253511730	CLI C 3-9 GE/SW L3 MP	● yellow	17 / 11 mm	L3	20
0253511733	CLI C 3-9 GE/SW PE MP	● yellow	17 / 11 mm	PE	20
1872661733	CLI C 3-9 GE/SW PEN MP	● yellow	17 / 11 mm	PEN	20
0253511735	CLI C 3-9 GE/SW SL MP	● yellow	17 / 11 mm	SL	20
0253511750	CLI C 3-9 GE/SW X1 MP	● yellow	17 / 11 mm	X1	20
0253511751	CLI C 3-9 GE/SW X2 MP	● yellow	17 / 11 mm	X2	20
0253511752	CLI C 3-9 GE/SW X3 MP	● yellow	17 / 11 mm	X3	20

## CLI R 02 Blank (MultiPack)

## Technical data

Material	Fire class acc. to UL 94	Temperature range	Wire O.D.	Version
PVC, soft, without Cadmium	V-0	-30 °C...80 °C	1.3 - 3 mm	MultiPack

## Ordering data

Order No.	Type	Colour	Depth / Width	Printing	Qty.
0560001687	CLI R 02-3 GE NE	● yellow	4 / 3.4 mm	Blank	10



## CLI R 1 Blank (MultiPack)

## Technical data

Material	Fire class acc. to UL 94	Temperature range	Wire O.D.	Version
PVC, soft, without Cadmium	V-0	-30 °C...80 °C	2.5 - 5 mm	MultiPack

## Ordering data

Order No.	Type	Colour	Depth / Width	Printing	Qty.
0572900002	CLI R 1-3 BL NE	● blue	5 / 4.2 mm	Blank	10
0572901687	CLI R 1-3 GE NE	● yellow	5 / 4.2 mm	Blank	10

## CLI R 02 Custom print (MultiPack)

## Technical data

Material	Fire class acc. to UL 94	Temperature range	Wire O.D.	Version
PVC, soft, without Cadmium	V-0	-30 °C...80 °C	1.3 - 3 mm	MultiPack

## Ordering data

Order No.	Type	Colour	Depth / Width	Printing	Qty.
0560009999	CLI R 02-3 SDR	CSP	4 / 3.4 mm	Custom printing	10



## CLI R 1 Custom print (MultiPack)

## Technical data

Material	Fire class acc. to UL 94	Temperature range	Wire O.D.	Version
PVC, soft, without Cadmium	V-0	-30 °C...80 °C	2.5 - 5 mm	MultiPack

## Ordering data

Order No.	Type	Colour	Depth / Width	Printing	Qty.
0572909999	CLI R 1-3 SDR	CSP	5 / 4.2 mm	Custom printing	10

## CLI R 02 International colour code (MultiPack)

## Technical data

Material	Fire class acc. to UL 94	Temperature range	Wire O.D.	Version
PVC, soft, without Cadmium	V-0	-30 °C...80 °C	1.3 - 3 mm	MultiPack

## Ordering data

Order No.	Type	Colour	Depth / Width	Printing	Qty.
0560001503	CLI R 02-3 SW/WS 0	● black	4 / 3.4 mm	0	10
0560001506	CLI R 02-3 BR/WS 1	● brown	4 / 3.4 mm	1	10
0560001509	CLI R 02-3 RT/WS 2	● red	4 / 3.4 mm	2	10
0560001512	CLI R 02-3 OR/SW 3	● orange	4 / 3.4 mm	3	10
0560001513	CLI R 02-3 GE/SW 4	● yellow	4 / 3.4 mm	4	10
0560001518	CLI R 02-3 GN/WS 5	● green	4 / 3.4 mm	5	10
0560001521	CLI R 02-3 BL/WS 6	● blue	4 / 3.4 mm	6	10
0560001524	CLI R 02-3 VI/WS 7	● violet	4 / 3.4 mm	7	10
0560001527	CLI R 02-3 GR/SW 8	● grey	4 / 3.4 mm	8	10
0560001530	CLI R 02-3 WS/SW 9	○ white	4 / 3.4 mm	9	10



## CLI R 02 Numeric sequence (MultiPack)

## Technical data

Material	Fire class acc. to UL 94	Temperature range	Wire O.D.	Version
PVC, soft, without Cadmium	V-0	-30 °C...80 °C	1.3 - 3 mm	MultiPack

## Ordering data

Order No.	Type	Colour	Depth / Width	Printing	Qty.
0560001501	CLI R 02-3 GE/SW 0	● yellow	4 / 3.4 mm	0	10
0560001504	CLI R 02-3 GE/SW 1	● yellow	4 / 3.4 mm	1	10
0560001507	CLI R 02-3 GE/SW 2	● yellow	4 / 3.4 mm	2	10
0560001510	CLI R 02-3 GE/SW 3	● yellow	4 / 3.4 mm	3	10
0560001513	CLI R 02-3 GE/SW 4	● yellow	4 / 3.4 mm	4	10
0560001516	CLI R 02-3 GE/SW 5	● yellow	4 / 3.4 mm	5	10
0560001519	CLI R 02-3 GE/SW 6	● yellow	4 / 3.4 mm	6	10
0560001522	CLI R 02-3 GE/SW 7	● yellow	4 / 3.4 mm	7	10
0560001525	CLI R 02-3 GE/SW 8	● yellow	4 / 3.4 mm	8	10
0560001528	CLI R 02-3 GE/SW 9	● yellow	4 / 3.4 mm	9	10



## CLI R 02 Alphabetic (MultiPack)

## Technical data

Material	Fire class acc. to UL 94	Temperature range	Wire O.D.	Version
PVC, soft, without Cadmium	V-0	-30 °C...80 °C	1.3 - 3 mm	MultiPack

## Ordering data

Order No.	Type	Colour	Depth / Width	Printing	Qty.
0560001638	CLI R 02-3 GE/SW A	● yellow	4 / 3.4 mm	A	10
0560001640	CLI R 02-3 GE/SW B	● yellow	4 / 3.4 mm	B	10
0560001642	CLI R 02-3 GE/SW C	● yellow	4 / 3.4 mm	C	10
0560001644	CLI R 02-3 GE/SW D	● yellow	4 / 3.4 mm	D	10
0560001646	CLI R 02-3 GE/SW E	● yellow	4 / 3.4 mm	E	10
0560001648	CLI R 02-3 GE/SW F	● yellow	4 / 3.4 mm	F	10
0560001650	CLI R 02-3 GE/SW G	● yellow	4 / 3.4 mm	G	10
0560001652	CLI R 02-3 GE/SW H	● yellow	4 / 3.4 mm	H	10
0560001654	CLI R 02-3 GE/SW I	● yellow	4 / 3.4 mm	I	10
0560001656	CLI R 02-3 GE/SW J	● yellow	4 / 3.4 mm	J	10
0560001658	CLI R 02-3 GE/SW K	● yellow	4 / 3.4 mm	K	10
0560001660	CLI R 02-3 GE/SW L	● yellow	4 / 3.4 mm	L	10
0560001662	CLI R 02-3 GE/SW M	● yellow	4 / 3.4 mm	M	10
0560001664	CLI R 02-3 GE/SW N	● yellow	4 / 3.4 mm	N	10
0560001666	CLI R 02-3 GE/SW O	● yellow	4 / 3.4 mm	O	10
0560001668	CLI R 02-3 GE/SW P	● yellow	4 / 3.4 mm	P	10
0560001670	CLI R 02-3 GE/SW Q	● yellow	4 / 3.4 mm	Q	10
0560001672	CLI R 02-3 GE/SW R	● yellow	4 / 3.4 mm	R	10
0560001675	CLI R 02-3 GE/SW S	● yellow	4 / 3.4 mm	S	10
0560001678	CLI R 02-3 GE/SW T	● yellow	4 / 3.4 mm	T	10
0560001680	CLI R 02-3 GE/SW U	● yellow	4 / 3.4 mm	U	10
0560001682	CLI R 02-3 GE/SW V	● yellow	4 / 3.4 mm	V	10
0560001684	CLI R 02-3 GE/SW W	● yellow	4 / 3.4 mm	W	10
0560001693	CLI R 02-3 GE/SW X	● yellow	4 / 3.4 mm	X	10
0560001697	CLI R 02-3 GE/SW Y	● yellow	4 / 3.4 mm	Y	10
0560001699	CLI R 02-3 GE/SW Z	● yellow	4 / 3.4 mm	Z	10



## CLI R 02 Special characters (MultiPack)

## Technical data

Material	Fire class acc. to UL 94	Temperature range	Wire O.D.	Version
PVC, soft, without Cadmium	V-0	-30 °C...80 °C	1.3 - 3 mm	MultiPack

## Ordering data

Order No.	Type	Colour	Depth / Width	Printing	Qty.
0560001738	CLI R 02-3 GE/SW +	● yellow	4 / 3.4 mm	+	10
0560001740	CLI R 02-3 GE/SW -	● yellow	4 / 3.4 mm	-	10
0560001749	CLI R 02-3 GE/SW .	● yellow	4 / 3.4 mm	.	10
0560001743	CLI R 02-3 GE/SW /	● yellow	4 / 3.4 mm	/	10
0560001698	CLI R 02-3 GE/SW Å	● yellow	4 / 3.4 mm	Å	10
0560001695	CLI R 02-3 GE/SW Ö	● yellow	4 / 3.4 mm	Ö	10



**CLI R 02-3 Special characters (MultiPack)****Technical data**

Material	Fire class acc. to UL 94	Temperature range	Wire O.D.	Version
PVC, soft, without Cadmium	V-0	-30 °C...80 °C	1.3 - 3 mm	MultiPack

**Ordering data**

Order No.	Type	Colour	Depth / Width	Printing	Qty.
0560001739	CLI R 02-3 RT/WS +	● red	4 / 3.4 mm	+	10
0560001741	CLI R 02-3 BL/WS -	● blue	4 / 3.4 mm	-	10

**CLI R 1 International colour code (MultiPack)****Technical data**

Material	Fire class acc. to UL 94	Temperature range	Wire O.D.	Version
PVC, soft, without Cadmium	V-0	-30 °C...80 °C	2.5 - 5 mm	MultiPack

**Ordering data**

Order No.	Type	Colour	Depth / Width	Printing	Qty.
0572901502	CLI R 1-3 SW/WS 0	● black	5 / 4.2 mm	0	10
0572901505	CLI R 1-3 BR/WS 1	● brown	5 / 4.2 mm	1	10
0572901508	CLI R 1-3 RT/WS 2	● red	5 / 4.2 mm	2	10
0572901511	CLI R 1-3 OR/SW 3	● orange	5 / 4.2 mm	3	10
0572901515	CLI R 1-3 GE/SW 4	● yellow	5 / 4.2 mm	4	10
0572901517	CLI R 1-3 GN/WS 5	● green	5 / 4.2 mm	5	10
0572901520	CLI R 1-3 BL/WS 6	● blue	5 / 4.2 mm	6	10
0572901523	CLI R 1-3 VI/WS 7	● violet	5 / 4.2 mm	7	10
0572901526	CLI R 1-3 GR/SW 8	● grey	5 / 4.2 mm	8	10
0572901529	CLI R 1-3 WS/SW 9	○ white	5 / 4.2 mm	9	10

**CLI R 1-3 Numeric sequence (MultiPack)****Technical data**

Material	Fire class acc. to UL 94	Temperature range	Wire O.D.	Version
PVC, soft, without Cadmium	V-0	-30 °C...80 °C	2.5 - 5 mm	MultiPack

**Ordering data**

Order No.	Type	Colour	Depth / Width	Printing	Qty.
0572901503	CLI R 1-3 GE/SW 0	● yellow	5 / 4.2 mm	0	10
0572901506	CLI R 1-3 GE/SW 1	● yellow	5 / 4.2 mm	1	10
0572901509	CLI R 1-3 GE/SW 2	● yellow	5 / 4.2 mm	2	10
0572901512	CLI R 1-3 GE/SW 3	● yellow	5 / 4.2 mm	3	10
0572901515	CLI R 1-3 GE/SW 4	● yellow	5 / 4.2 mm	4	10
0572901518	CLI R 1-3 GE/SW 5	● yellow	5 / 4.2 mm	5	10
0572901521	CLI R 1-3 GE/SW 6	● yellow	5 / 4.2 mm	6	10
0572901524	CLI R 1-3 GE/SW 7	● yellow	5 / 4.2 mm	7	10
0572901527	CLI R 1-3 GE/SW 8	● yellow	5 / 4.2 mm	8	10
0572901530	CLI R 1-3 GE/SW 9	● yellow	5 / 4.2 mm	9	10



## CLI R 1-3 Alphabetic (MultiPack)

## Technical data

Material	Fire class acc. to UL 94	Temperature range	Wire O.D.	Version
PVC, soft, without Cadmium	V-0	-30 °C...80 °C	2.5 - 5 mm	MultiPack

## Ordering data

Order No.	Type	Colour	Depth / Width	Printing	Qty.
0572901638	CLI R 1-3 GE/SW A	● yellow	5 / 4.2 mm	A	10
0572901640	CLI R 1-3 GE/SW B	● yellow	5 / 4.2 mm	B	10
0572901642	CLI R 1-3 GE/SW C	● yellow	5 / 4.2 mm	C	10
0572901644	CLI R 1-3 GE/SW D	● yellow	5 / 4.2 mm	D	10
0572901646	CLI R 1-3 GE/SW E	● yellow	5 / 4.2 mm	E	10
0572901648	CLI R 1-3 GE/SW F	● yellow	5 / 4.2 mm	F	10
0572901650	CLI R 1-3 GE/SW G	● yellow	5 / 4.2 mm	G	10
0572901652	CLI R 1-3 GE/SW H	● yellow	5 / 4.2 mm	H	10
0572901654	CLI R 1-3 GE/SW I	● yellow	5 / 4.2 mm	I	10
0572901656	CLI R 1-3 GE/SW J	● yellow	5 / 4.2 mm	J	10
0572901658	CLI R 1-3 GE/SW K	● yellow	5 / 4.2 mm	K	10
0572901660	CLI R 1-3 GE/SW L	● yellow	5 / 4.2 mm	L	10
0572901662	CLI R 1-3 GE/SW M	● yellow	5 / 4.2 mm	M	10
0572901664	CLI R 1-3 GE/SW N	● yellow	5 / 4.2 mm	N	10
0572901666	CLI R 1-3 GE/SW O	● yellow	5 / 4.2 mm	O	10
0572901668	CLI R 1-3 GE/SW P	● yellow	5 / 4.2 mm	P	10
0572901670	CLI R 1-3 GE/SW Q	● yellow	5 / 4.2 mm	Q	10
0572901672	CLI R 1-3 GE/SW R	● yellow	5 / 4.2 mm	R	10
0572901675	CLI R 1-3 GE/SW S	● yellow	5 / 4.2 mm	S	10
0572901678	CLI R 1-3 GE/SW T	● yellow	5 / 4.2 mm	T	10
0572901680	CLI R 1-3 GE/SW U	● yellow	5 / 4.2 mm	U	10
0572901682	CLI R 1-3 GE/SW V	● yellow	5 / 4.2 mm	V	10
0572901684	CLI R 1-3 GE/SW W	● yellow	5 / 4.2 mm	W	10
0572901693	CLI R 1-3 GE/SW X	● yellow	5 / 4.2 mm	X	10
0572901697	CLI R 1-3 GE/SW Y	● yellow	5 / 4.2 mm	Y	10
0572901699	CLI R 1-3 GE/SW Z	● yellow	5 / 4.2 mm	Z	10



## CLI R 1-3 Special characters (MultiPack)

## Technical data

Material	Fire class acc. to UL 94	Temperature range	Wire O.D.	Version
PVC, soft, without Cadmium	V-0	-30 °C...80 °C	2.5 - 5 mm	MultiPack

## Ordering data

Order No.	Type	Colour	Depth / Width	Printing	Qty.
0572901738	CLI R 1-3 GE/SW +	● yellow	5 / 4.2 mm	+	10
0572901740	CLI R 1-3 GE/SW -	● yellow	5 / 4.2 mm	-	10
0572901749	CLI R 1-3 GE/SW .	● yellow	5 / 4.2 mm	.	10
0572901743	CLI R 1-3 GE/SW /	● yellow	5 / 4.2 mm	/	10
0572901745	CLI R 1-3 GE/SW ET	● yellow	5 / 4.2 mm	⊥	10
0572901698	CLI R 1-3 GE/SW Ä	● yellow	5 / 4.2 mm	Ä	10
0572901741	CLI R 1-3 BL/WS -	● blue	5 / 4.2 mm	-	10
0572901746	CLI R 1-3 BL/WS N	● blue	5 / 4.2 mm	N	10
0572901739	CLI R 1-3 RT/WS +	● red	5 / 4.2 mm	+	10







# CLI O – Open wire markers

CLI O wire markers are fitted to connected wires, which makes them suitable for updating existing facilities. Three different sizes are available to mark wire cross-sections from 0.4 mm<sup>2</sup> to maximum 4.0 mm<sup>2</sup>. Profile and design guarantee the secure and permanent attachment of the individually combinable markers.

### Advantages:

- Open markers for connected wires
- Marker profile with anti-rotation safeguard for combination marking
- Perfect for all marking tasks of retrofitted wiring
- Extremely low space requirements
- Rapid clip-on attachment saves time



Open marker from type CLI O also allows mounting onto already connected wires.

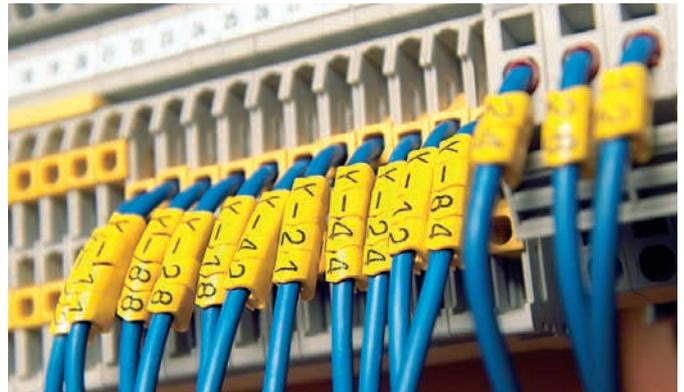

### CLI O

Version	Open markers made from hard PVC. The flexible and sturdy barbed hooks guarantee secure attachment on the wire. Standard, special prints available.
Material	Hard PVC, cadmium- and silicone-free
Temperature range	-30 °C ... 80 °C
Flammability classification	Corresponds to V0 to UL 94
Resistance	Highly resistant to oils and petrol as well as gamma and UV radiation
Printing	Laser marking

### Wire cross-section

CLI O 10	0.4 mm <sup>2</sup> - 1.5 mm <sup>2</sup>
CLI O 20	1.5 mm <sup>2</sup> - 3 mm <sup>2</sup>
CLI O 30	3 mm <sup>2</sup> - 4 mm <sup>2</sup>

**CLI C 10 Blank (MultiPack)****Technical data**

Material	Temperature range	Fire class acc. to UL 94	Wire O.D.	Version
PVC, soft, without Cadmium	-30 °C...80 °C	V-0	2 - 3 mm	MultiPack

**Ordering data**

Order No.	Type	Colour	Depth / Width	Printing	Qty.
0689600000	CLI O 10-3 GE NE MP	● yellow	4 / 4 mm	Blank	200

**CLI O 20 Blank (MultiPack)****Technical data**

Material	Temperature range	Fire class acc. to UL 94	Wire O.D.	Version
PVC, soft, without Cadmium	-30 °C...80 °C	V-0	3 - 4 mm	MultiPack

**Ordering data**

Order No.	Type	Colour	Depth / Width	Printing	Qty.
0689700000	CLI O 20-3 GE NE MP	● yellow	5 / 5.5 mm	Blank	200

**CLI O 30 Blank (MultiPack)****Technical data**

Material	Temperature range	Fire class acc. to UL 94	Wire O.D.	Version
PVC, soft, without Cadmium	-30 °C...80 °C	V-0	4 - 5 mm	MultiPack

**Ordering data**

Order No.	Type	Colour	Depth / Width	Printing	Qty.
0689800000	CLI O 30-3 GE NE MP	● yellow	6 / 6 mm	Blank	200

**CLI O 10 Custom Printing (MultiPack)****Technical data**

Material	Temperature range	Fire class acc. to UL 94	Wire O.D.	Version
PVC, soft, without Cadmium	-30 °C...80 °C	V-0	2 - 3 mm	MultiPack

**Ordering data**

Order No.	Type	Colour	Depth / Width	Printing	Qty.
0648009999	CLI O 10-3 SDR MP	CSP	4 / 4 mm	Custom printing	1000

**CLI O 20 Custom Printing (MultiPack)****Technical data**

Material	Temperature range	Fire class acc. to UL 94	Wire O.D.	Version
PVC, soft, without Cadmium	-30 °C...80 °C	V-0	3 - 4 mm	MultiPack

**Ordering data**

Order No.	Type	Colour	Depth / Width	Printing	Qty.
0648109999	CLI O 20-3 SDR MP	CSP	5 / 5.5 mm	Custom printing	1000



### CLI O 30 Custom Printing (MultiPack)

#### Technical data

Material	Temperature range	Fire class acc. to UL 94	Wire O.D.	Version
PVC, soft, without Cadmium	-30 °C...80 °C	V-0	4 - 5 mm	MultiPack

#### Ordering data

Order No.	Type	Colour	Depth / Width	Printing	Qty.
0648209999	CLI O 30-3 SDR MP	CSP	6 / 6 mm	Custom printing	1000



### CLI O 10 Alphabetic (MultiPack)

#### Technical data

Material	Temperature range	Fire class acc. to UL 94	Wire O.D.	Version
PVC, soft, without Cadmium	-30 °C...80 °C	V-0	2 - 3 mm	MultiPack

#### Ordering data

Order No.	Type	Colour	Depth / Width	Printing	Qty.
0648001637	CLI O 10-3 GE/SW A MP	● yellow	4 / 4 mm	A	200
0648001639	CLI O 10-3 GE/SW B MP	● yellow	4 / 4 mm	B	200
0648001641	CLI O 10-3 GE/SW C MP	● yellow	4 / 4 mm	C	200
0648001643	CLI O 10-3 GE/SW D MP	● yellow	4 / 4 mm	D	200
0648001645	CLI O 10-3 GE/SW E MP	● yellow	4 / 4 mm	E	200
0648001647	CLI O 10-3 GE/SW F MP	● yellow	4 / 4 mm	F	200
0648001649	CLI O 10-3 GE/SW G MP	● yellow	4 / 4 mm	G	200
0648001651	CLI O 10-3 GE/SW H MP	● yellow	4 / 4 mm	H	200
0648001653	CLI O 10-3 GE/SW I MP	● yellow	4 / 4 mm	I	200
0648001655	CLI O 10-3 GE/SW J MP	● yellow	4 / 4 mm	J	200
0648001657	CLI O 10-3 GE/SW K MP	● yellow	4 / 4 mm	K	200
0648001659	CLI O 10-3 GE/SW L MP	● yellow	4 / 4 mm	L	200
0648001661	CLI O 10-3 GE/SW M MP	● yellow	4 / 4 mm	M	200
0648001663	CLI O 10-3 GE/SW N MP	● yellow	4 / 4 mm	N	200
0648001665	CLI O 10-3 GE/SW O MP	● yellow	4 / 4 mm	O	200
0648001667	CLI O 10-3 GE/SW P MP	● yellow	4 / 4 mm	P	200
0648001669	CLI O 10-3 GE/SW Q MP	● yellow	4 / 4 mm	Q	200
0648001671	CLI O 10-3 GE/SW R MP	● yellow	4 / 4 mm	R	200
0648001673	CLI O 10-3 GE/SW S MP	● yellow	4 / 4 mm	S	200
0648001676	CLI O 10-3 GE/SW T MP	● yellow	4 / 4 mm	T	200
0648001679	CLI O 10-3 GE/SW U MP	● yellow	4 / 4 mm	U	200
0648001681	CLI O 10-3 GE/SW V MP	● yellow	4 / 4 mm	V	200
0648001683	CLI O 10-3 GE/SW W MP	● yellow	4 / 4 mm	W	200
0648001687	CLI O 10-3 GE/SW X MP	● yellow	4 / 4 mm	X	200
0648001696	CLI O 10-3 GE/SW Y MP	● yellow	4 / 4 mm	Y	200
0648001698	CLI O 10-3 GE/SW Z MP	● yellow	4 / 4 mm	Z	200



### CLI O 10 Special characters (MultiPack)

#### Technical data

Material	Temperature range	Fire class acc. to UL 94	Wire O.D.	Version
PVC, soft, without Cadmium	-30 °C...80 °C	V-0	2 - 3 mm	MultiPack

#### Ordering data

Order No.	Type	Colour	Depth / Width	Printing	Qty.
0648001738	CLI O 10-3 GE/SW + MP	● yellow	4 / 4 mm	+	200
0648001740	CLI O 10-3 GE/SW - MP	● yellow	4 / 4 mm	-	200
0648001746	CLI O 10-3 GE/SW ET MP	● yellow	4 / 4 mm	±	200
0648001697	CLI O 10-3 GE/SW Å MP	● yellow	4 / 4 mm	Å	200
0648001699	CLI O 10-3 GE/SW Ä MP	● yellow	4 / 4 mm	Ä	200
0648001695	CLI O 10-3 GE/SW Ö MP	● yellow	4 / 4 mm	Ö	200



## CLI O 20 Numeric sequence (MultiPack)

## Technical data

Material	Temperature range	Fire class acc. to UL 94	Wire O.D.	Version
PVC, soft, without Cadmium	-30 °C...80 °C	V-0	3 - 4 mm	MultiPack

## Ordering data

Order No.	Type	Colour	Depth / Width	Printing	Qty.
0648101502	CLI O 20-3 GE/SW 0 MP	● yellow	5 / 5.5 mm	0	200
0648101505	CLI O 20-3 GE/SW 1 MP	● yellow	5 / 5.5 mm	1	200
0648101508	CLI O 20-3 GE/SW 2 MP	● yellow	5 / 5.5 mm	2	200
0648101511	CLI O 20-3 GE/SW 3 MP	● yellow	5 / 5.5 mm	3	200
0648101514	CLI O 20-3 GE/SW 4 MP	● yellow	5 / 5.5 mm	4	200
0648101517	CLI O 20-3 GE/SW 5 MP	● yellow	5 / 5.5 mm	5	200
0648101520	CLI O 20-3 GE/SW 6 MP	● yellow	5 / 5.5 mm	6	200
0648101523	CLI O 20-3 GE/SW 7 MP	● yellow	5 / 5.5 mm	7	200
0648101526	CLI O 20-3 GE/SW 8 MP	● yellow	5 / 5.5 mm	8	200
0648101529	CLI O 20-3 GE/SW 9 MP	● yellow	5 / 5.5 mm	9	200



## CLI O 20 Alphabetic (MultiPack)

## Technical data

Material	Temperature range	Fire class acc. to UL 94	Wire O.D.	Version
PVC, soft, without Cadmium	-30 °C...80 °C	V-0	3 - 4 mm	MultiPack

## Ordering data

Order No.	Type	Colour	Depth / Width	Printing	Qty.
0648101637	CLI O 20-3 GE/SW A MP	● yellow	5 / 5.5 mm	A	200
0648101639	CLI O 20-3 GE/SW B MP	● yellow	5 / 5.5 mm	B	200
0648101641	CLI O 20-3 GE/SW C MP	● yellow	5 / 5.5 mm	C	200
0648101643	CLI O 20-3 GE/SW D MP	● yellow	5 / 5.5 mm	D	200
0648101645	CLI O 20-3 GE/SW E MP	● yellow	5 / 5.5 mm	E	200
0648101647	CLI O 20-3 GE/SW F MP	● yellow	5 / 5.5 mm	F	200
0648101649	CLI O 20-3 GE/SW G MP	● yellow	5 / 5.5 mm	G	200
0648101651	CLI O 20-3 GE/SW H MP	● yellow	5 / 5.5 mm	H	200
0648101653	CLI O 20-3 GE/SW I MP	● yellow	5 / 5.5 mm	I	200
0648101655	CLI O 20-3 GE/SW J MP	● yellow	5 / 5.5 mm	J	200
0648101657	CLI O 20-3 GE/SW K MP	● yellow	5 / 5.5 mm	K	200
0648101659	CLI O 20-3 GE/SW L MP	● yellow	5 / 5.5 mm	L	200
0648101661	CLI O 20-3 GE/SW M MP	● yellow	5 / 5.5 mm	M	200
0648101663	CLI O 20-3 GE/SW N MP	● yellow	5 / 5.5 mm	N	200
0648101665	CLI O 20-3 GE/SW O MP	● yellow	5 / 5.5 mm	O	200
0648101667	CLI O 20-3 GE/SW P MP	● yellow	5 / 5.5 mm	P	200
0648101669	CLI O 20-3 GE/SW Q MP	● yellow	5 / 5.5 mm	Q	200
0648101671	CLI O 20-3 GE/SW R MP	● yellow	5 / 5.5 mm	R	200
0648101673	CLI O 20-3 GE/SW S MP	● yellow	5 / 5.5 mm	S	200
0648101676	CLI O 20-3 GE/SW T MP	● yellow	5 / 5.5 mm	T	200
0648101679	CLI O 20-3 GE/SW U MP	● yellow	5 / 5.5 mm	U	200
0648101681	CLI O 20-3 GE/SW V MP	● yellow	5 / 5.5 mm	V	200
0648101683	CLI O 20-3 GE/SW W MP	● yellow	5 / 5.5 mm	W	200
0648101687	CLI O 20-3 GE/SW X MP	● yellow	5 / 5.5 mm	X	200
0648101696	CLI O 20-3 GE/SW Y MP	● yellow	5 / 5.5 mm	Y	200
0648101698	CLI O 20-3 GE/SW Z MP	● yellow	5 / 5.5 mm	Z	200



### CLI O 20 Special characters (MultiPack)

#### Technical data

Material	Temperature range	Fire class acc. to UL 94	Wire O.D.	Version
PVC, soft, without Cadmium	-30 °C...80 °C	V-0	3 - 4 mm	MultiPack

#### Ordering data

Order No.	Type	Colour	Depth / Width	Printing	Qty.
0648101738	CLI O 20-3 GE/SW + MP	● yellow	5 / 5.5 mm	+	200
0648101740	CLI O 20-3 GE/SW - MP	● yellow	5 / 5.5 mm	-	200
0648101697	CLI O 20-3 GE/SW Ä MP	● yellow	5 / 5.5 mm	Ä	200
0648101699	CLI O 20-3 GE/SW Å MP	● yellow	5 / 5.5 mm	Å	200
0648101695	CLI O 20-3 GE/SW Ö MP	● yellow	5 / 5.5 mm	Ö	200



### CLI O 30 Numeric sequence (MultiPack)

#### Technical data

Material	Temperature range	Fire class acc. to UL 94	Wire O.D.	Version
PVC, soft, without Cadmium	-30 °C...80 °C	V-0	4 - 5 mm	MultiPack

#### Ordering data

Order No.	Type	Colour	Depth / Width	Printing	Qty.
0648201502	CLI O 30-3 GE/SW 0 MP	● yellow	6 / 6 mm	0	200
0648201505	CLI O 30-3 GE/SW 1 MP	● yellow	6 / 6 mm	1	200
0648201508	CLI O 30-3 GE/SW 2 MP	● yellow	6 / 6 mm	2	200
0648201511	CLI O 30-3 GE/SW 3 MP	● yellow	6 / 6 mm	3	200
0648201514	CLI O 30-3 GE/SW 4 MP	● yellow	6 / 6 mm	4	200
0648201517	CLI O 30-3 GE/SW 5 MP	● yellow	6 / 6 mm	5	200
0648201520	CLI O 30-3 GE/SW 6 MP	● yellow	6 / 6 mm	6	200
0648201523	CLI O 30-3 GE/SW 7 MP	● yellow	6 / 6 mm	7	200
0648201526	CLI O 30-3 GE/SW 8 MP	● yellow	6 / 6 mm	8	200
0648201529	CLI O 30-3 GE/SW 9 MP	● yellow	6 / 6 mm	9	200



## CLI O 30 Alphabetic (MultiPack)

## Technical data

Material	Temperature range	Fire class acc. to UL 94	Wire O.D.	Version
PVC, soft, without Cadmium	-30 °C...80 °C	V-0	4 - 5 mm	MultiPack

## Ordering data

Order No.	Type	Colour	Depth / Width	Printing	Qty.
0648201637	CLI O 30-3 GE/SW A MP	● yellow	6 / 6 mm	A	200
0648201639	CLI O 30-3 GE/SW B MP	● yellow	6 / 6 mm	B	200
0648201641	CLI O 30-3 GE/SW C MP	● yellow	6 / 6 mm	C	200
0648201643	CLI O 30-3 GE/SW D MP	● yellow	6 / 6 mm	D	200
0648201645	CLI O 30-3 GE/SW E MP	● yellow	6 / 6 mm	E	200
0648201647	CLI O 30-3 GE/SW F MP	● yellow	6 / 6 mm	F	200
0648201649	CLI O 30-3 GE/SW G MP	● yellow	6 / 6 mm	G	200
0648201651	CLI O 30-3 GE/SW H MP	● yellow	6 / 6 mm	H	200
0648201653	CLI O 30-3 GE/SW I MP	● yellow	6 / 6 mm	I	200
0648201655	CLI O 30-3 GE/SW J MP	● yellow	6 / 6 mm	J	200
0648201657	CLI O 30-3 GE/SW K MP	● yellow	6 / 6 mm	K	200
0648201659	CLI O 30-3 GE/SW L MP	● yellow	6 / 6 mm	L	200
0648201661	CLI O 30-3 GE/SW M MP	● yellow	6 / 6 mm	M	200
0648201663	CLI O 30-3 GE/SW N MP	● yellow	6 / 6 mm	N	200
0648201665	CLI O 30-3 GE/SW O MP	● yellow	6 / 6 mm	O	200
0648201667	CLI O 30-3 GE/SW P MP	● yellow	6 / 6 mm	P	200
0648201669	CLI O 30-3 GE/SW Q MP	● yellow	6 / 6 mm	Q	200
0648201671	CLI O 30-3 GE/SW R MP	● yellow	6 / 6 mm	R	200
0648201673	CLI O 30-3 GE/SW S MP	● yellow	6 / 6 mm	S	200
0648201676	CLI O 30-3 GE/SW T MP	● yellow	6 / 6 mm	T	200
0648201679	CLI O 30-3 GE/SW U MP	● yellow	6 / 6 mm	U	200
0648201681	CLI O 30-3 GE/SW V MP	● yellow	6 / 6 mm	V	200
0648201683	CLI O 30-3 GE/SW W MP	● yellow	6 / 6 mm	W	200
0648201687	CLI O 30-3 GE/SW X MP	● yellow	6 / 6 mm	X	200
0648201696	CLI O 30-3 GE/SW Y MP	● yellow	6 / 6 mm	Y	200
0648201698	CLI O 30-3 GE/SW Z MP	● yellow	6 / 6 mm	Z	200



## CLI O 30 Special characters (MultiPack)

## Technical data

Material	Temperature range	Fire class acc. to UL 94	Wire O.D.	Version
PVC, soft, without Cadmium	-30 °C...80 °C	V-0	4 - 5 mm	MultiPack

## Ordering data

Order No.	Type	Colour	Depth / Width	Printing	Qty.
0648201738	CLI O 30-3 GE/SW + MP	● yellow	6 / 6 mm	+	200
0648201740	CLI O 30-3 GE/SW - MP	● yellow	6 / 6 mm	-	200
0648201746	CLI O 30-3 GE/SW ET MP	● yellow	6 / 6 mm	⊥	200
0648201697	CLI O 30-3 GE/SW Å MP	● yellow	6 / 6 mm	Å	200
0648201699	CLI O 30-3 GE/SW Ä MP	● yellow	6 / 6 mm	Ä	200
0648201695	CLI O 30-3 GE/SW Ö MP	● yellow	6 / 6 mm	Ö	200



## CabelLine® CLI M – Cable markers and holders

CLI M identification markers simply slide onto CLI MH carrier strips and are secured by means of cable ties. CLI MH strips are available in two lengths. This system is particularly suitable for wires and cables with large cross-sections.

### Advantages:

- Combination markers for marking cables and conduits
- One size for all diameters from 16 mm<sup>2</sup>
- Unrestricted combination options
- Closed, captive marking
- Very good legibility



Markers from type CLI M are pushed onto holding strips of type CLI MH and finally mounted with cable ties.

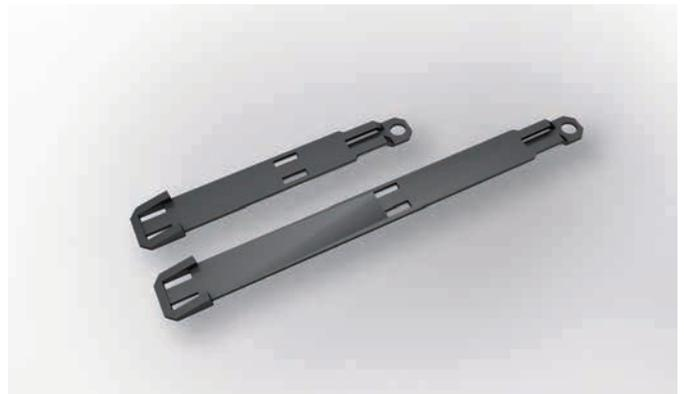

### CLI MH

Version	CLI MH carrier strips for CLI M markers are available in lengths of 70 and 110 mm for 10 or 20 CLI M markers respectively. They are attached using one or two cable ties.
Material	PA 6.6
Temperature range	-30 °C ... 80 °C
Flammability classification	Corresponds to V2 to UL 94
Resistance	Highly resistant to oils and petrol as well as gamma and UV radiation
Printing	Maximum 6.2 mm

### CLI M

Version	Closed, oval combination markers. The markers are slid onto CLI MH holders and secured by means of cable ties. Standard, special and international colour-code compliant prints available.
Material	Soft PVC, cadmium- and silicone-free
Temperature range	-30 °C ... 80 °C
Flammability classification	Corresponds to V0 to UL 94
Resistance	Highly resistant to oils and petrol as well as gamma and UV radiation
Printing	Laser marking

### Wire cross-section

CLI M 2	16 mm <sup>2</sup> – 500 mm <sup>2</sup>
---------	--



**CLI M 2 Blank (on loop)****Technical data**

Material	Temperature range	Fire class acc. to UL 94	Wire O.D.	Version
PVC, soft, without Cadmium	-30 °C...80 °C	V-0	10 - 317 mm	Loop

**Ordering data**

Order No.	Type	Colour	Depth / Width	Printing	Qty.
1886531687	CLI M 2-25Q GE NE SG	● yellow	3 / 11.4 mm	Blank	1000
1886541687	CLI M 2-40Q GE NE SG	● yellow	3 / 11.4 mm	Blank	500

**CLI M 2 Blank (CD)****Technical data**

Material	Temperature range	Fire class acc. to UL 94	Wire O.D.	Version
PVC, soft, without Cadmium	-30 °C...80 °C	V-0	10 - 317 mm	CD

**Ordering data**

Order No.	Type	Colour	Depth / Width	Printing	Qty.
1568300001	CLI M 2-4 GE NE CD	● yellow	3 / 11.4 mm	Blank	500

**CLI M 2 Blank (MultiPack)****Technical data**

Material	Temperature range	Fire class acc. to UL 94	Wire O.D.	Version
PVC, soft, without Cadmium	-30 °C...80 °C	V-0	10 - 317 mm	MultiPack

**Ordering data**

Order No.	Type	Colour	Depth / Width	Printing	Qty.
1733650004	CLI M 2-4 GE NE MP	● yellow	3 / 11.4 mm	Blank	100

**CLI M Custom Printing (on loop)****Technical data**

Material	Temperature range	Fire class acc. to UL 94	Wire O.D.	Version
PVC, soft, without Cadmium	-30 °C...80 °C	V-0	10 - 317 mm	Loop

**Ordering data**

Order No.	Type	Colour	Depth / Width	Printing	Qty.
1912830000	CLI M 2-4 SDR SG	● yellow	3 / 11.4 mm	Custom printing	100
1912840000	CLI M 2-6 SDR SG	● yellow	3 / 11.4 mm	Custom printing	100
1873440000	CLI M 2-9 SDR SG	● yellow	3 / 11.4 mm	Custom printing	100
1873450000	CLI M 2-12 SDR SG	● yellow	3 / 11.4 mm	Custom printing	100
1899260000	CLI M 2-15 SDR SG	● yellow	3 / 11.4 mm	Custom printing	100
1899230000	CLI M 2-18 SDR SG	● yellow	3 / 11.4 mm	Custom printing	100
1873460000	CLI M 2-21 SDR SG	● yellow	3 / 11.4 mm	Custom printing	100
1912860000	CLI M 2-24 SDR SG	● yellow	3 / 11.4 mm	Custom printing	100
1579500000	CLI M 2-25Q SDR SG	● yellow	3 / 11.4 mm	Custom printing	100
1912870000	CLI M 2-27 SDR SG	● yellow	3 / 11.4 mm	Custom printing	100
1912880000	CLI M 2-30 SDR SG	● yellow	3 / 11.4 mm	Custom printing	100
1912920000	CLI M 2-33 SDR SG	● yellow	3 / 11.4 mm	Custom printing	100
1912950000	CLI M 2-36 SDR SG	● yellow	3 / 11.4 mm	Custom printing	100
1912960000	CLI M 2-39 SDR SG	● yellow	3 / 11.4 mm	Custom printing	100
1634790000	CLI M 2-40Q SDR SG	● yellow	3 / 11.4 mm	Custom printing	100



### CLI M Custom Printing (CD)

#### Technical data

Material	Temperature range	Fire class acc. to UL 94	Wire O.D.	Version
PVC, soft, without Cadmium	-30 °C...80 °C	V-0	10 - 317 mm	CD

#### Ordering data

Order No.	Type	Colour	Depth / Width	Printing	Qty.
1568309999	CLI M 2-4 SDR CD	● yellow	3 / 11.4 mm	Custom printing	500
1871789999	CLI M 2-6 SDR CD	● yellow	3 / 11.4 mm	Custom printing	250
1899250000	CLI M 2-9 SDR CD	● yellow	3 / 11.4 mm	Custom printing	200



### CLI M 2-4 International color code (MultiPack)

#### Technical data

Material	Temperature range	Fire class acc. to UL 94	Wire O.D.	Version
PVC, soft, without Cadmium	-30 °C...80 °C	V-0	10 - 317 mm	MultiPack

#### Ordering data

Order No.	Type	Colour	Depth / Width	Printing	Qty.
1733651503	CLI M 2-4 SW/WS 0 MP	● black	3 / 11.3 mm	0	100
1733651506	CLI M 2-4 BR/WS 1 MP	● brown	3 / 11.3 mm	1	100
1733651509	CLI M 2-4 RT/WS 2 MP	● red	3 / 11.3 mm	2	100
1733651512	CLI M 2-4 OR/SW 3 MP	● orange	3 / 11.3 mm	3	100
1733651514	CLI M 2-4 GE/SW 4 MP	● yellow	3 / 11.3 mm	4	100
1733651518	CLI M 2-4 GN/WS 5 MP	● green	3 / 11.3 mm	5	100
1733651521	CLI M 2-4 BL/WS 6 MP	● blue	3 / 11.3 mm	6	100
1733651524	CLI M 2-4 VI/WS 7 MP	● violet	3 / 11.3 mm	7	100
1733651527	CLI M 2-4 GR/SW 8 MP	● grey	3 / 11.3 mm	8	100
1733651530	CLI M 2-4 WS/SW 9 MP	○ white	3 / 11.3 mm	9	100



### CLI M 2-4 Special characters (MultiPack)

#### Technical data

Material	Temperature range	Fire class acc. to UL 94	Wire O.D.	Version
PVC, soft, without Cadmium	-30 °C...80 °C	V-0	10 - 317 mm	MultiPack

#### Ordering data

Order No.	Type	Colour	Depth / Width	Printing	Qty.
1733651742	CLI M 2-4 GE/SW / MP	● yellow	3 / 11.3 mm	/	100
1733651738	CLI M 2-4 GE/SW + MP	● yellow	3 / 11.3 mm	+	100
1733651740	CLI M 2-4 GE/SW - MP	● yellow	3 / 11.3 mm	-	100
1733651748	CLI M 2-4 GE/SW . MP	● yellow	3 / 11.3 mm	.	100
1733651750	CLI M 2-4 GE/SW : MP	● yellow	3 / 11.3 mm	:	100
1733651751	CLI M 2-4 GE/SW = MP	● yellow	3 / 11.3 mm	=	100
1733651752	CLI M 2-4 GE/SW AC MP	● yellow	3 / 11.3 mm	AC	100
1733651746	CLI M 2-4 GE/SW ET MP	● yellow	3 / 11.3 mm	⊥	100
1733651747	CLI M 2-4 GE/SW PET. MP	● yellow	3 / 11.3 mm	⊕	100
1733651697	CLI M 2-4 GE/SW Å MP	● yellow	3 / 11.3 mm	Å	100
1733651699	CLI M 2-4 GE/SW Å MP	● yellow	3 / 11.3 mm	Å	100
1733651695	CLI M 2-4 GE/SW Ö MP	● yellow	3 / 11.3 mm	Ö	100



## CLI M 2-4 Numeric sequence (MultiPack)

## Technical data

Material	Temperature range	Fire class acc. to UL 94	Wire O.D.	Version
PVC, soft, without Cadmium	-30 °C...80 °C	V-0	10 - 317 mm	MultiPack

## Ordering data

Order No.	Type	Colour	Depth / Width	Printing	Qty.
1733651514	CLI M 2-4 GE/SW 4 MP	● yellow	3 / 11.3 mm	4	100
1733651502	CLI M 2-4 GE/SW 0 MP	● yellow	3 / 11.3 mm	0	100
1733651505	CLI M 2-4 GE/SW 1 MP	● yellow	3 / 11.3 mm	1	100
1733651508	CLI M 2-4 GE/SW 2 MP	● yellow	3 / 11.3 mm	2	100
1733651511	CLI M 2-4 GE/SW 3 MP	● yellow	3 / 11.3 mm	3	100
1733651517	CLI M 2-4 GE/SW 5 MP	● yellow	3 / 11.3 mm	5	100
1733651520	CLI M 2-4 GE/SW 6 MP	● yellow	3 / 11.3 mm	6	100
1733651523	CLI M 2-4 GE/SW 7 MP	● yellow	3 / 11.3 mm	7	100
1733651526	CLI M 2-4 GE/SW 8 MP	● yellow	3 / 11.3 mm	8	100
1733651529	CLI M 2-4 GE/SW 9 MP	● yellow	3 / 11.3 mm	9	100



## CLI M 2-4 Alphabetic (MultiPack)

## Technical data

Material	Temperature range	Fire class acc. to UL 94	Wire O.D.	Version
PVC, soft, without Cadmium	-30 °C...80 °C	V-0	10 - 317 mm	MultiPack

## Ordering data

Order No.	Type	Colour	Depth / Width	Printing	Qty.
1733651637	CLI M 2-4 GE/SW A MP	● yellow	3 / 11.3 mm	A	100
1733651639	CLI M 2-4 GE/SW B MP	● yellow	3 / 11.3 mm	B	100
1733651641	CLI M 2-4 GE/SW C MP	● yellow	3 / 11.3 mm	C	100
1733651643	CLI M 2-4 GE/SW D MP	● yellow	3 / 11.3 mm	D	100
1733651645	CLI M 2-4 GE/SW E MP	● yellow	3 / 11.3 mm	E	100
1733651647	CLI M 2-4 GE/SW F MP	● yellow	3 / 11.3 mm	F	100
1733651649	CLI M 2-4 GE/SW G MP	● yellow	3 / 11.3 mm	G	100
1733651651	CLI M 2-4 GE/SW H MP	● yellow	3 / 11.3 mm	H	100
1733651653	CLI M 2-4 GE/SW I MP	● yellow	3 / 11.3 mm	I	100
1733651655	CLI M 2-4 GE/SW J MP	● yellow	3 / 11.3 mm	J	100
1733651657	CLI M 2-4 GE/SW K MP	● yellow	3 / 11.3 mm	K	100
1733651659	CLI M 2-4 GE/SW L MP	● yellow	3 / 11.3 mm	L	100
1733651661	CLI M 2-4 GE/SW M MP	● yellow	3 / 11.3 mm	M	100
1733651663	CLI M 2-4 GE/SW N MP	● yellow	3 / 11.3 mm	N	100
1733651665	CLI M 2-4 GE/SW O MP	● yellow	3 / 11.3 mm	O	100
1733651667	CLI M 2-4 GE/SW P MP	● yellow	3 / 11.3 mm	P	100
1733651669	CLI M 2-4 GE/SW Q MP	● yellow	3 / 11.3 mm	Q	100
1733651671	CLI M 2-4 GE/SW R MP	● yellow	3 / 11.3 mm	R	100
1733651673	CLI M 2-4 GE/SW S MP	● yellow	3 / 11.3 mm	S	100
1733651676	CLI M 2-4 GE/SW T MP	● yellow	3 / 11.3 mm	T	100
1733651679	CLI M 2-4 GE/SW U MP	● yellow	3 / 11.3 mm	U	100
1733651681	CLI M 2-4 GE/SW V MP	● yellow	3 / 11.3 mm	V	100
1733651683	CLI M 2-4 GE/SW W MP	● yellow	3 / 11.3 mm	W	100
1733651687	CLI M 2-4 GE/SW X MP	● yellow	3 / 11.3 mm	X	100
1733651696	CLI M 2-4 GE/SW Y MP	● yellow	3 / 11.3 mm	Y	100
1733651698	CLI M 2-4 GE/SW Z MP	● yellow	3 / 11.3 mm	Z	100



**CLI M 2-4 International colour code (CD)**

**Technical data**

Material	Temperature range	Fire class acc. to UL 94	Wire O.D.	Version
PVC, soft, without Cadmium	-30 °C...80 °C	V-0	10 - 317 mm	CD

**Ordering data**

Order No.	Type	Colour	Depth / Width	Printing	Qty.
1568301503	CLI M 2-4 SW/WS 0 CD	● black	3 / 11.3 mm	0	500
1568301506	CLI M 2-4 BR/WS 1 CD	● brown	3 / 11.3 mm	1	500
1568301509	CLI M 2-4 RT/WS 2 CD	● red	3 / 11.3 mm	2	500
1568301512	CLI M 2-4 OR/SW 3 CD	● orange	3 / 11.3 mm	3	500
1568301514	CLI M 2-4 GE/SW 4 CD	● yellow	3 / 11.3 mm	4	500
1568301518	CLI M 2-4 GN/WS 5 CD	● green	3 / 11.3 mm	5	500
1568301521	CLI M 2-4 BL/WS 6 CD	● blue	3 / 11.3 mm	6	500
1568301524	CLI M 2-4 VI/WS 7 CD	● violet	3 / 11.3 mm	7	500
1568301527	CLI M 2-4 GR/SW 8 CD	● grey	3 / 11.3 mm	8	500
1568301530	CLI M 2-4 WS/SW 9 CD	○ white	3 / 11.3 mm	9	500



**CLOI M 2-4 Special characters (CD)**

**Technical data**

Material	Temperature range	Fire class acc. to UL 94	Wire O.D.	Version
PVC, soft, without Cadmium	-30 °C...80 °C	V-0	10 - 317 mm	CD

**Ordering data**

Order No.	Type	Colour	Depth / Width	Printing	Qty.
1568301742	CLI M 2-4 GE/SW / CD	● yellow	3 / 11.3 mm	/	500
1568301738	CLI M 2-4 GE/SW + CD	● yellow	3 / 11.3 mm	+	500
1568301740	CLI M 2-4 GE/SW - CD	● yellow	3 / 11.3 mm	-	500
1568301748	CLI M 2-4 GE/SW . CD	● yellow	3 / 11.3 mm	.	500
1568301750	CLI M 2-4 GE/SW : CD	● yellow	3 / 11.3 mm	:	500
1568301751	CLI M 2-4 GE/SW = CD	● yellow	3 / 11.3 mm	=	500
1568301752	CLI M 2-4 GE/SW AC CD	● yellow	3 / 11.3 mm	AC	500
1568301746	CLI M 2-4 GE/SW ET CD	● yellow	3 / 11.3 mm	⊥	500
1568301747	CLI M 2-4 GE/SW PET. CD	● yellow	3 / 11.3 mm	Ⓣ	500
1568301694	CLI M 2-4 GE/SW Å CD	● yellow	3 / 11.3 mm	Å	500
1568301699	CLI M 2-4 GE/SW Ä CD	● yellow	3 / 11.3 mm	Ä	500
1568301735	CLI M 2-4 GE/SW Æ CD	● yellow	3 / 11.3 mm	Æ	500
1568301695	CLI M 2-4 GE/SW Ö CD	● yellow	3 / 11.3 mm	Ö	500
1568301736	CLI M 2-4 GE/SW Ø CD	● yellow	3 / 11.3 mm	Ø	500
1568301741	CLI M 2-4 BL/WS - CD	● blue	3 / 11.3 mm	-	500



## CLI M 2-4 Numeric sequence (CD)

## Technical data

Material	Temperature range	Fire class acc. to UL 94	Wire O.D.	Version
PVC, soft, without Cadmium	-30 °C...80 °C	V-0	10 - 317 mm	CD

## Ordering data

Order No.	Type	Colour	Depth / Width	Printing	Qty.	
1568301000	CLI M 2-4 WS/SW 0 CD	○	white	3 / 11.3 mm	0	500
1568301502	CLI M 2-4 GE/SW 0 CD	●	yellow	3 / 11.3 mm	0	500
1568301697	CLI M 2-4 WS/SW 1 CD	○	white	3 / 11.3 mm	1	500
1568301505	CLI M 2-4 GE/SW 1 CD	●	yellow	3 / 11.3 mm	1	500
1568301514	CLI M 2-4 GE/SW 4 CD	●	yellow	3 / 11.3 mm	4	500
1568300002	CLI M 2-4 WS/SW 2 CD	○	white	3 / 11.3 mm	2	500
1568301508	CLI M 2-4 GE/SW 2 CD	●	yellow	3 / 11.3 mm	2	500
1568300003	CLI M 2-4 WS/SW 3 CD	○	white	3 / 11.3 mm	3	500
1568301511	CLI M 2-4 GE/SW 3 CD	●	yellow	3 / 11.3 mm	3	500
1568300004	CLI M 2-4 WS/SW 4 CD	○	white	3 / 11.3 mm	4	500
1568301530	CLI M 2-4 WS/SW 9 CD	○	white	3 / 11.3 mm	9	500
1568300005	CLI M 2-4 WS/SW 5 CD	○	white	3 / 11.3 mm	5	500
1568301517	CLI M 2-4 GE/SW 5 CD	●	yellow	3 / 11.3 mm	5	500
1568300006	CLI M 2-4 WS/SW 6 CD	○	white	3 / 11.3 mm	6	500
1568301520	CLI M 2-4 GE/SW 6 CD	●	yellow	3 / 11.3 mm	6	500
1568300007	CLI M 2-4 WS/SW 7 CD	○	white	3 / 11.3 mm	7	500
1568301523	CLI M 2-4 GE/SW 7 CD	●	yellow	3 / 11.3 mm	7	500
1568300008	CLI M 2-4 WS/SW 8 CD	○	white	3 / 11.3 mm	8	500
1568301526	CLI M 2-4 GE/SW 8 CD	●	yellow	3 / 11.3 mm	8	500
1568301529	CLI M 2-4 GE/SW 9 CD	●	yellow	3 / 11.3 mm	9	500

## CLI M 2-4 Alphabetic (CD)

## Technical data

Material	Temperature range	Fire class acc. to UL 94	Wire O.D.	Version
PVC, soft, without Cadmium	-30 °C...80 °C	V-0	10 - 317 mm	CD

## Ordering data

Order No.	Type	Colour	Depth / Width	Printing	Qty.	
1568301637	CLI M 2-4 GE/SW A CD	●	yellow	3 / 11.3 mm	A	500
1568301639	CLI M 2-4 GE/SW B CD	●	yellow	3 / 11.3 mm	B	500
1568301641	CLI M 2-4 GE/SW C CD	●	yellow	3 / 11.3 mm	C	500
1568301643	CLI M 2-4 GE/SW D CD	●	yellow	3 / 11.3 mm	D	500
1568301645	CLI M 2-4 GE/SW E CD	●	yellow	3 / 11.3 mm	E	500
1568301647	CLI M 2-4 GE/SW F CD	●	yellow	3 / 11.3 mm	F	500
1568301649	CLI M 2-4 GE/SW G CD	●	yellow	3 / 11.3 mm	G	500
1568301651	CLI M 2-4 GE/SW H CD	●	yellow	3 / 11.3 mm	H	500
1568301653	CLI M 2-4 GE/SW I CD	●	yellow	3 / 11.3 mm	I	500
1568301655	CLI M 2-4 GE/SW J CD	●	yellow	3 / 11.3 mm	J	500
1568301657	CLI M 2-4 GE/SW K CD	●	yellow	3 / 11.3 mm	K	500
1568301659	CLI M 2-4 GE/SW L CD	●	yellow	3 / 11.3 mm	L	500
1568301661	CLI M 2-4 GE/SW M CD	●	yellow	3 / 11.3 mm	M	500
1568301663	CLI M 2-4 GE/SW N CD	●	yellow	3 / 11.3 mm	N	500
1568301665	CLI M 2-4 GE/SW O CD	●	yellow	3 / 11.3 mm	O	500
1568301667	CLI M 2-4 GE/SW P CD	●	yellow	3 / 11.3 mm	P	500
1568301669	CLI M 2-4 GE/SW Q CD	●	yellow	3 / 11.3 mm	Q	500
1568301671	CLI M 2-4 GE/SW R CD	●	yellow	3 / 11.3 mm	R	500
1568301673	CLI M 2-4 GE/SW S CD	●	yellow	3 / 11.3 mm	S	500
1568301676	CLI M 2-4 GE/SW T CD	●	yellow	3 / 11.3 mm	T	500
1568301679	CLI M 2-4 GE/SW U CD	●	yellow	3 / 11.3 mm	U	500
1568301681	CLI M 2-4 GE/SW V CD	●	yellow	3 / 11.3 mm	V	500
1568301683	CLI M 2-4 GE/SW W CD	●	yellow	3 / 11.3 mm	W	500
1568301687	CLI M 2-4 GE/SW X CD	●	yellow	3 / 11.3 mm	X	500
1568301696	CLI M 2-4 GE/SW Y CD	●	yellow	3 / 11.3 mm	Y	500
1568301698	CLI M 2-4 GE/SW Z CD	●	yellow	3 / 11.3 mm	Z	500



### CLI M 2-6 Special characters (CD)

#### Technical data

Material	Temperature range	Fire class acc. to UL 94	Wire O.D.	Version
PVC, soft, without Cadmium	-30 °C...80 °C	V-0	10 - 317 mm	CD

#### Ordering data

Order No.	Type	Colour	Depth / Width	Printing	Qty.
1871781728	CLI M 2-6 GE/SW L1 CD	● yellow	3 / 11.3 mm	L1	250
1871781729	CLI M 2-6 GE/SW L2 CD	● yellow	3 / 11.3 mm	L2	250
1871781730	CLI M 2-6 GE/SW L3 CD	● yellow	3 / 11.3 mm	L3	250



### CLI M 2-6 Special characters (MultiPack)

#### Technical data

Material	Temperature range	Fire class acc. to UL 94	Wire O.D.	Version
PVC, soft, without Cadmium	-30 °C...80 °C	V-0	10 - 317 mm	MultiPack

#### Ordering data

Order No.	Type	Colour	Depth / Width	Printing	Qty.
1871751728	CLI M 2-6 GE/SW L1 MP	● yellow	3 / 11.3 mm	L1	100
1871751729	CLI M 2-6 GE/SW L2 MP	● yellow	3 / 11.3 mm	L2	100
1871751730	CLI M 2-6 GE/SW L3 MP	● yellow	3 / 11.3 mm	L3	100



## CLI RH

Holder for fitting CLI R 02 (red) or CLI R 1 (blue) mounting mandrels

### Technical data

Material	
Polyamide	

### Ordering data

Order No.	Type	Colour	Depth / Width	Qty.
0563700000	CLI RH 20-02 CLI R 02	● red	28 / 55 mm	1
0563600000	CLI RH 20-10 CLI R 10	● blue	28 / 55 mm	1



## CLI R

The CLI R mounting mandrels are ideal for applying CLI C markers to conductors.

- CLI R 02 for CLI C 02-3
- CLI R 1 for CLI C 1-3

### Technical data

Material	
POM	

### Ordering data

Order No.	Type	Colour	Depth / Width	Qty.
0559900000	CLI R 02 F. CLI C 02-3	● red	1.5 / 2 mm	20
0532100000	CLI R 1 F. CLI C 1-3	● blue	2 / 2.5 mm	20

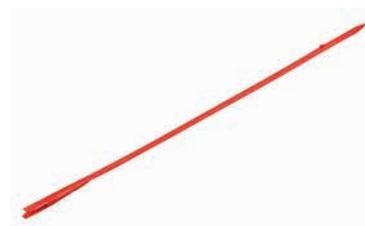

## CLI RS

The CLI RS metal mounting mandrels are ideal for applying CLI RS markers to conductors.

- CLI RS 3 for CLI C 02
- CLI RS 4 for CLI C 02 and CLI C 1 (max. Ø 4.2mm)
- CLI RS 5 for CLI C 1 (max. Ø 5mm)

### Technical data

Material	
Steel	

### Ordering data

Order No.	Type	Colour	Depth / Width	Qty.
0559200000	CLI RS 3 MDCLI C 02	● silver	3 / 3 mm	1
0559300000	CLI RS 4 MDCLI C1+02	● silver	4 / 4 mm	1
0648300000	CLI RS 5 MDCLI C 1	● silver	5 / 5 mm	1



## Holders for CLI M markers

The CLI MH holder strip for CLI M markers is available in lengths of 70 and 100 mm for 10, respectively 20 CLI M 2-4. Held in place with one or two cable ties.

### Technical data

Material	
Polyamide 66	

### Ordering data

Order No.	Type	Colour	Depth / Width	Qty.
0189400000	CLI MH 110 HSTR	● black	3 / 11.3 mm	100
0524400000	CLI MH 70 HSTR	● black	3 / 11.3 mm	100



**WSK**

Assortment box with 12 compartments for placing CLI markers.  
WSK 12 (0336000000) is filled with CLI C 1-3 GE printed from von 0 to 9.

**Technical data**

<b>Material</b>
Polystyrene

**Ordering data**

Order No.	Type	Colour	Depth / Width	Qty.
0335900000	WSK 12 , LEER	Transparent	185 mm	1
0336000000	WSK 12 M. CLI C 1-3 GE/SW BEZ.0-9/+/- ●	orange	185 mm	1

**CLI CD box**

Steel cassette for holding CLI-CDs

- 25 CLI-CDs with CLI C 02-3
- 21 CLI-CDs with CLI C 1-3
- 14 CLI-CDs with CLI C 2-4
- 11 CLI-CDs with CLI M 2-4

**Technical data**

<b>Material</b>
Sheet steel

**Ordering data**

Order No.	Type	Colour	Depth / Width	Qty.
1763290000	CLI CD-BOX ○	white	160 mm	1







## WSM – Stainless steel markers

WSM is a complete marking system for cables, wires, conduits and components. It offers markings that last in conditions that no other markers can withstand. The range consists of stainless steel character tiles, holders and cable ties – available separately or complete in the WSM Set and Service Box.

### Advantages:

- Durable, embossed characters for optimum legibility
- Resistant to heat, cold, corrosion, acids, chemicals, fire and more
- Individual and multi-character markings can also be combined
- Rapid attachment
- Ideal for outdoor applications
- Easy attachment with cable ties

### Contents of WSM Service Box:

Character tiles

40 each of

0-9, A-Ö, +, -, x, /, :, ;, ~, =, ü,  $\frac{1}{2}$ , neutral.

Cable ties

200 cable ties 200 mm

Stainless steel holders

30 pieces each of 48 mm and 60 mm,

20 pieces of 84 mm

10 pieces of 108 mm and 288 mm



### WSM

Version	Marker holders designed with raised profiles at both ends to ensure the cable ties slide through easily. Individual or combined, the single marker plates are inserted into the holder. Special printing available.
Material	Acid-resistant stainless steel grade SS 2348 (AISI-316)
Temperature range	-80 °C ... 500 °C
Resistance	Fireproof. Resistant to heat, cold, corrosion, acids, chemical substances, and so forth.
Printing	High-quality embossed. Alphanumeric and special characters
Fixing accessories	Stainless steel cable ties with ball-bearing lock

## WSM small plates

## Technical data

Material	Temperature range	Fire class acc. to UL 94	Wire O.D.	Width
Stainless steel 1.4404	500 °C			9.9 mm

## Ordering data

Order No.	Type	Colour	Depth	Printing	Qty.
1712501000	WSM 10 0	● silver	0.3 mm	0	200
1712500001	WSM 10 1	● silver	0.3 mm	1	200
1712500002	WSM 10 2	● silver	0.3 mm	2	200
1712500003	WSM 10 3	● silver	0.3 mm	3	200
1712500004	WSM 10 4	● silver	0.3 mm	4	200
1712500005	WSM 10 5	● silver	0.3 mm	5	200
1712500006	WSM 10 6	● silver	0.3 mm	6	200
1712500007	WSM 10 7	● silver	0.3 mm	7	200
1712500008	WSM 10 8	● silver	0.3 mm	8	200
1712500009	WSM 10 9	● silver	0.3 mm	9	200
1712501637	WSM 10 A	● silver	0.3 mm	A	200
1712501639	WSM 10 B	● silver	0.3 mm	B	200
1712501641	WSM 10 C	● silver	0.3 mm	C	200
1712501643	WSM 10 D	● silver	0.3 mm	D	200
1712501645	WSM 10 E	● silver	0.3 mm	E	200
1712501647	WSM 10 F	● silver	0.3 mm	F	200
1712501649	WSM 10 G	● silver	0.3 mm	G	200
1712501651	WSM 10 H	● silver	0.3 mm	H	200
1712501653	WSM 10 I	● silver	0.3 mm	I	200
1712501655	WSM 10 J	● silver	0.3 mm	J	200
1712501657	WSM 10 K	● silver	0.3 mm	K	200
1712501659	WSM 10 L	● silver	0.3 mm	L	200
1712501661	WSM 10 M	● silver	0.3 mm	M	200
1712501663	WSM 10 N	● silver	0.3 mm	N	200
1712501665	WSM 10 O	● silver	0.3 mm	O	200
1712501667	WSM 10 P	● silver	0.3 mm	P	200
1712501669	WSM 10 Q	● silver	0.3 mm	Q	200
1712501671	WSM 10 R	● silver	0.3 mm	R	200
1712501673	WSM 10 S	● silver	0.3 mm	S	200
1712501676	WSM 10 T	● silver	0.3 mm	T	200
1712501679	WSM 10 U	● silver	0.3 mm	U	200
1712501681	WSM 10 V	● silver	0.3 mm	V	200
1712501683	WSM 10 W	● silver	0.3 mm	W	200
1712501687	WSM 10 X	● silver	0.3 mm	X	200
1712501696	WSM 10 Y	● silver	0.3 mm	Y	200
1712501698	WSM 10 Z	● silver	0.3 mm	Z	200
1712501054	WSM 10 Ä	● silver	0.3 mm	Ä	200
1712501700	WSM 10 Å	● silver	1 mm	Å	200
1712501672	WSM 10 Æ	● silver	1 mm	Æ	200
1712501055	WSM 10 Ö	● silver	0.3 mm	Ö	200
1712501670	WSM 10 Ø	● silver	1 mm	Ø	200
1712501699	WSM 10 Ü	● silver	1 mm	Ü	200
1712501056	WSM 10 ~	● silver	0.3 mm	~	200
1712501744	WSM 10 (	● silver	0.3 mm	(	200
1712501738	WSM 10 +	● silver	0.3 mm	+	200
1712501740	WSM 10 -	● silver	0.3 mm	-	200
1712501743	WSM 10 .	● silver	0.3 mm	.	200
1712501739	WSM 10 /	● silver	0.3 mm	/	200
1712501741	WSM 10 :	● silver	0.3 mm	:	200
1712501742	WSM 10 =	● silver	0.3 mm	=	200
1712501053	WSM 10 ERDE	● silver	0.3 mm	⊥	200
1924930000	WSM SERVICE BOX KOMP.	● silver	109 mm	see text	1



## WSM – stainless steel markers

## WSM holder

## Technical data

Material	Temperature range	Fire class acc. to UL 94	Wire O.D.	Width
Stainless steel 1.4404	250 °C			11

## Ordering data

Order No.	Type	Colour	Depth	Number of characters	Qty.
1774500000	WSMH 48MM	● silver	0.3 mm	6	50
1774510000	WSMH 60MM	● silver	0.3 mm	8	50
1774520000	WSMH 84MM	● silver	0.3 mm	12	50
1774530000	WSMH 108MM	● silver	0.3 mm	16	50
1002680000	WSMH 176MM	● silver	0.3 mm	28	50
1774490000	WSMH 288MM	● silver	0.3 mm	46	50



## WSM holder custom printing

## Technical data

Material	Temperature range	Fire class acc. to UL 94	Wire O.D.	Width
Stainless steel 1.4404	500 °C			10

## Ordering data

Order No.	Type	Colour	Depth	Number of characters	Qty.
1912170000	WSMC 1-5	● silver	0.5 mm	5	1
1891680000	WSMC 6-10	● silver	0.5 mm	10	1
1891670000	WSMC 11-15	● silver	0.5 mm	15	1
1912140000	WSMC 16-20	● silver	0.5 mm	20	1
1912150000	WSMC 21-25	● silver	0.5 mm	25	1
1912160000	WSMC 26-30	● silver	0.5 mm	30	1



## Labels - standard print

## Symbol Pack

## Technical data

Material	Adhesive	Fire class acc. to UL 94	Temperature range	Colour
Acrylic-coated fibre webbing	Permanent acrylic copolymer		-45 °C...80 °C	yellow

## Ordering data

Order No.	Type	Number	Width / Height	Printing	Qty.
1741090000	SYMBOL-P. 25X25X25 B/DR	12	25 / 25 mm		120
1741100000	SYMBOL-P. 50X50X50 B/DR	4	50 / 50 mm		40
1741110000	SYMBOL-P. 75X75X75 B/DR	2	75 / 75 mm		20



## Service Pack

## Technical data

Material	Adhesive	Fire class acc. to UL 94	Temperature range	Colour
Acrylic-coated fibre webbing	Permanent acrylic copolymer		-45 °C...80 °C	black

## Ordering data

Order No.	Type	Number	Width / Height	Printing	Qty.
1707350001	SERV-P. DIAM16 L1 SW/WS	20	16 / 16 mm	L1	200
1707350002	SERV-P. DIAM16 L2 SW/WS	20	16 / 16 mm	L2	200
1707350003	SERV-P. DIAM16 L3 SW/WS	20	16 / 16 mm	L3	200
1707350004	SERV-P. DIAM16 N BL/WS	20	16 / 16 mm	N	200
1707350006	SERV-P. DIAM16 PE GE/GN	20	16 / 16 mm	PE	200
1707350005	SERV-P. DIAM16 ERDE GE/GN	20	16 / 16 mm		200

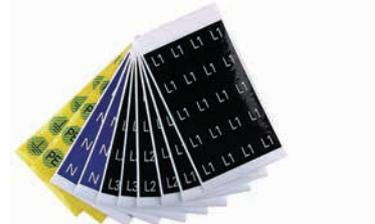

## Marko Cards

## Technical data

Material	Adhesive	Fire class acc. to UL 94	Temperature range	Colour
Acrylic-coated fibre webbing	Permanent acrylic copolymer		-29 °C...80 °C	yellow

## Ordering data

Order No.	Type	Number	Width / Height	Printing	Qty.
1700530001	MARKO-C. 25X25X25 B/DR.		25 / 25 mm		140
1700540001	MARKO-C. 50X50X50 B/DR.		50 / 50 mm		70
1700550001	MARKO-C. 100X100X100 B/DR		100 / 100 mm		30
1700560001	MARKO-C. 200X200X200 B/DR		200 / 200 mm		10



## PageTab

## Technical data

Material	Adhesive	Fire class acc. to UL 94	Temperature range	Colour
Acrylic-coated fibre webbing	Permanent acrylic copolymer		-29 °C...93 °C	yellow

## Ordering data

Order No.	Type	Number	Width / Height	Printing	Qty.
1686160000	PAGETAB 15/9	310	15 / 9 mm	Neutral	7750
1686170000	PAGETAB 19/11	200	19 / 11 mm	Neutral	5000
1686180000	PAGETAB 20/8	280	20 / 8 mm	Neutral	7000
1686190000	PAGETAB 28/11	125	28 / 11 mm	Neutral	3125
1686200000	PAGETAB 38/11	100	38 / 11 mm	Neutral	2500
1686210000	PAGETAB 56/22	24	56 / 22 mm	Neutral	600
1686220000	PAGETAB 60/35	16	60 / 35 mm	Neutral	400

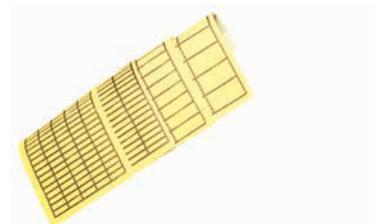

**TABPACK FLAG bag****Technical data**

Material	Temperature range	Fire class acc. to UL 94	Adhesive
Cotton fabric	-29 °C...80 °C	V-0	Natural rubber adhesive

**Ordering data**

Order No.	Type	Colour	Height	Width	Qty.
1107340000	TABPACK FLAG 54/8 WS	○ white	8 mm	54 mm	120

**TABPACK****Technical data**

Material	Temperature range	Fire class acc. to UL 94	Adhesive
Acrylic-coated fibre webbing	-29 °C...80 °C		Permanent acrylic copolymer

**Ordering data**

Order No.	Type	Colour	Height	Width	Qty.
1686110000	TABPACK 14X9	● yellow	9 mm	14 mm	840
1686120000	TABPACK 15X6	● yellow	6 mm	15 mm	1000
1686130000	TABPACK 19X11 M. RAND	● yellow	11 mm	19 mm	440
1686140000	TABPACK 21X8	● yellow	8 mm	21 mm	620







**KSW 2.5 and KSW 4 neutral****Technical data**

Material	Colour	Adhesive
Polyester, PVC-free	white	Acrylate

**Ordering data**

Order No.	Type	Pitch in mm	Printing	Qty.
1812660000	KSW 2.5 EL WS 50M	2.50 mm	Neutral	50
1812670000	KSW 4.0 EL WS 50M	4.00 mm	Neutral	50

**KSW 2.5 und KSW 4 custom printing****Technical data**

Material	Colour	Adhesive
Polyester, PVC-free	white	Acrylate

**Ordering data**

Order No.	Type	Pitch in mm	Printing	Qty.
1629900000	KSW 2.5 < 50MM SDR	2.50 mm	Custom printing	1
1629920000	KSW 2,5 < 100MM SONDDR.	2.50 mm	Custom printing	1
1629940000	KSW 2,5 < 150MM SONDDR.	2.50 mm	Custom printing	1
1629910000	KSW 4 < 50MM SDR	50.00 mm	Custom printing	1
1629930000	KSW 4 < 100MM SDR	100.00 mm	Custom printing	1
1629950000	KSW 4 < 150MM SONDDR.	150.00 mm	Custom printing	1

**KSW 2.5 and KSW 4 standard printing****Technical data**

Material	Colour	Adhesive
Polyester, PVC-free	white	Acrylate

**Ordering data**

Order No.	Type	Pitch in mm	Printing	Qty.
1630100001	KSW 2,5 8/5,08 1-8	5.08 mm	1 - 8	10
1630100009	KSW 2,5 8/5,08 9-16	5.08 mm	9 - 16	10
1652250001	KSW 2,5 24/3,5 1-24	3.50 mm	1 - 24	10
1705820001	KSW 4 10/5,08 W 1-10	5.08 mm	1 - 10	10
1630150001	KSW 4 16/3,5 1-16	3.50 mm	1 - 16	10
1630160001	KSW 4 16/5,08 1-16	5.08 mm	1 - 16	10
1630160017	KSW 4 16/5,08 17-32	5.08 mm	17 - 32	10
1630200001	KSW 4 8/5,08 1-8	5.08 mm	1 - 8	10
1630180001	KSW 4 24/5,08 1-24	5.08 mm	1 - 24	10



# Accessories

<b>Accessories</b>	Tag carriers	F.2
	Transparent sleeves	F.10
	WKM - transparent sleeve for cable tie installation	F.16
	Tag rails - identification for side-by-side devices	F.20

# Tag carriers

## Compact modules for complex systems

### Simple identification of component assemblies and terminal blocks

Tag carriers, in combination with the different Weidmüller terminal markers, deliver quick and efficient solutions for labelling of component assemblies and terminal blocks. Available to you, for every solution, is a suitable tag carrier that is tailored according to your needs and matched to the MultiCard product line.

### Weidmüller tag carrier – the benefits to you

- Charge marking surface
- Protection against environmental influences
- Flexible folding mechanism
- Clear identification of assemblies
- Universal use on Grail and Top-hat rail



The group tag carrier SCHT 5 / SCHT 5 S can be directly snapped into the DIN rail TS 32 (G-rail) or the TS 35 (top-hat rail).



The ZGB 15 / ZGB 30 is a pivoting group tag carrier.



High level of protection for the labels against outside influences: The pouch of the EM 8/30 protects the inner workings similar to that of a clip fastener.

Tag carriers

WAD 27

27 mm

Terminal marker



WAD 27

27 mm

Terminal marker



Technical data

Material
Fire class acc. to UL 94
Ambient temperature (operational)
Application/manufacturer
Width
Height
Note

Polyamide 66
V-2
-40 °C...100 °C
Weidmueller
27 mm
64 mm

Polyamide 66
V-2
-40 °C...100 °C
Weidmueller
27 mm
64 mm

Ordering data

white	○
yellow	●
Note	

Type	Qty.	Order No.
WAD 27 NEUTRAL	10	1062960000

Type	Qty.	Order No.
WAD 27 M. BL.	10	1062860000

Technical drawing / application



**Tag carriers**

**Tag carriers**

**EM 8/30**

**7.2 mm**

**ZGB 15**

**7 mm**

Terminal marker



Terminal marker



**Technical data**

Material
Fire class acc. to UL 94
Ambient temperature (operational)
Application/manufacturer
Width
Height
Note

Polypropylene
HB
-40 °C...80 °C
Weidmueller
7.2 mm
32.4 mm

Polyamide 66
V2
-40 °C...100 °C
Weidmueller
7 mm
15 mm

**Ordering data**

Transparent
white
dark beige
Note

Type	Qty.	Order No.
EM 8/30	50	1806120000

Type	Qty.	Order No.
ZGB 15	20	1636530000

**Accessories**

<b>MultiCard</b>
<b>MultiMark</b>
<b>DIN A4 sheets</b>
Paper
Paper
Polyester
Polyester
<b>Protective strip</b>
Note

Type	Qty.	Order No.
ELS 6/30 MC NE WS	80	1045570000
ELS 6/30 MC NE GE	80	1045580000
ELS 6/30 MM WS	3000	2009980000
ELS 6/30 MM GE	3000	2010620000
ESO 7 DIN A4 WS	10	1607720000
ESO 7 DIN A4 GE	10	1634780000
ESO 7 P DIN A4 WS	10	1670390000
ESO 7 P DIN A4 GE	10	1670400000

Type	Qty.	Order No.
WS 12/5 MC NE WS	720	1609860000
DEK 5/5 MC NE WS	1000	1609801044
DEK 5/30 MC NE WS	100	1951920000
ESO 7 DIN A4 WS	10	1607720000
ESO 7 DIN A4 GE	10	1634780000
ESO 7 P DIN A4 WS	10	1670390000
ESO 7 P DIN A4 GE	10	1670400000
STR 7 F.SCHT 7	20	0515300000

**Technical drawing / application**

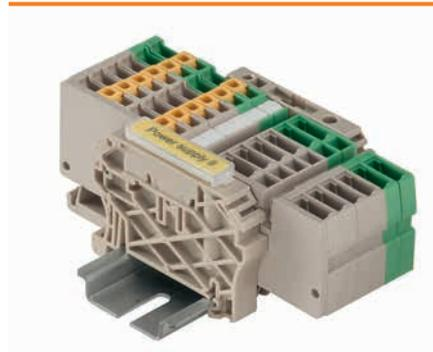

Tag carriers

ZGB 30

7 mm

BZT

5.07 mm

Terminal marker



Tag carriers



Technical data

Material
Fire class acc. to UL 94
Ambient temperature (operational)
Application/manufacturer
Width
Height
Note

Polyamide 66
V-2
-40 °C...100 °C
Weidmueller
7 mm
32 mm

Polyamide 66
V-2
-40 °C...100 °C
5.07 mm
7.55 mm

Ordering data

Transparent
white
dark beige
dark beige
dark beige
Note

Type	Qty.	Order No.
ZGB 30	20	1611930000

Type	Qty.	Order No.
BZT 1 WS 10/5	100	1805490000
BZT 2 WS 10/5	100	1805480000
BZT 1 ZA WS 10/5	100	1805520000

Accessories

MultiCard
MultiMark
DIN A4 sheets
Protective strip
Note

Type	Qty.	Order No.
WS 12/5 MC NE WS	720	1609860000
DEK 5/5 MC NE WS	1000	1609801044
DEK 5/30 MC NE WS	100	1951920000
ESD 7 DIN A4 WS	10	1607720000
ESD 7 DIN A4 GE	10	1634780000
ESD 7 P DIN A4 WS	10	1670390000
ESD 7 P DIN A4 GE	10	1670400000
STR 7 F.SCHT 7	20	0515300000

Type	Qty.	Order No.
WS 12/5 MC NE WS	720	1609860000
DEK 5/5 MC NE WS	1000	1609801044
WS 12/5 MM WS	800	2007190000
DEK 5/5 MM WS	800	2007110000

Technical drawing / application



Tag carriers

Tag carriers

Snap Mark

5 mm

SnapMark 1.5

3.5 mm

Terminal marker



Terminal marker



Technical data

Material
Fire class acc. to UL 94
Ambient temperature (operational)
Application/manufacture
Width
Height
Note

Polyamide 66
V-2
-40 °C...100 °C
Weidmueller
5 mm
23 mm

PA 66
V-2
-40 °C...100 °C
Weidmueller
3.5 mm
26 mm

Ordering data

white	○
Note	

Type	Qty.	Order No.
SNAPMARK I	50	1805880000

Type	Qty.	Order No.
SNAPMARK 1.5	40	2682080000

Accessories

MultiCard
MultiMark
Note

Type	Qty.	Order No.
WS 10/5 M MC NE WS	720	1792000000
DEK 5/5 MC NE WS	1000	1609801044
DEK 5/5 MM WS	800	2007110000
WS 10/5 MM WS	800	2712130000

Type	Qty.	Order No.
DEK 5/3.5 MC NE WS	500	1755270000
DEK 5/3.5 PLUS MC NE WS	1600	2003750000
DEK 5/3.5 MC NE GE	500	1369480000
DEK 5/3.5 MM BP WS	15000	2619760000
DEK 5/3.5 MM WS	1000	2007100000
WS 12/3.5 MM BP WS	8000	2619840000
WS 12/3.5 MM WS	1000	2007180000

Technical drawing / application





Tag carriers

**SCHT 5**

19.5 mm

Terminal marker



**SCHT 5 S**

9.5 mm

Terminal marker



**Technical data**

Material
Fire class acc. to UL 94
Ambient temperature (operational)
Application/manufacturer
Width
Height
Note

Polyamide 66
V-2
-40 °C...100 °C
Weidmueller
19.5 mm
44.5 mm

Polyamide 66
V-2
-40 °C...100 °C
Weidmueller
9.5 mm
44.5 mm

**Ordering data**

beige	●
white	○
Note	

Type	Qty.	Order No.
SCHT 5	20	0292460000

Type	Qty.	Order No.
SCHT 5 S	20	1631930000

**Accessories**

<b>MultiCard</b>	
<b>MultiMark</b>	
<b>DIN A4 sheets</b>	
Paper	
Paper	
Polyester	
Polyester	
<b>Protective strip</b>	
<b>Note</b>	

Type	Qty.	Order No.
ELS 16/40 MC NE WS	40	1045620000
ELS 16/40 MC NE GE	40	1045630000
ELS 16/40 MM WS	2000	2005200000
ELS 16/40 MM GE	2000	2005260000
ESO 5 DIN A4 WS	10	1607710000
ESO 5 DIN A4 GE	10	1631350000
ESO 5 P DIN A4 WS	10	1670370000
ESO 5 P DIN A4 GE	10	1670380000
STR 5 F.SCHT 5	20	0294000000

Type	Qty.	Order No.
ELS 7/40 MC NE WS	40	1045640000
ELS 7/40 MC NE GE	40	1045650000
ELS 7/40 MM WS	3000	2518620000
ELS 7/40 MM GE	3000	2519160000
ESO 5 S DIN A4 WS	10	1631920000
STR 5 S F.SCHT 5 S	20	1631940000

**Technical drawing / application**



Tag carriers

Tag carriers

**SCHT 7**

**8 mm**

Terminal marker



**Technical data**

Material
Fire class acc. to UL 94
Ambient temperature (operational)
Application/manufacturer
Width
Height
Note

Polyamide 66
V-2
-40 °C...100 °C
Weidmueller
8 mm
39.3 mm

**Ordering data**

beige	●
white	○
Note	

Type	Qty.	Order No.
SCHT 7	20	0517960000

**Accessories**

<b>MultiCard</b>
<b>MultiMark</b>
<b>DIN A4 sheets</b>
Paper
Paper
Polyester
Polyester
<b>Protective strip</b>
Note

Type	Qty.	Order No.
DEK 5/5 MC NE WS	1000	1609801044
WS 10/5 M MC NE WS	720	1792000000
ELS 6/30 MC NE WS	80	1045570000
ELS 6/30 MM WS	3000	2009980000
DEK 5/5 MM WS	800	2007110000
WS 10/5 MM WS	800	2712130000
ESO 7 DIN A4 WS	10	1607720000
ESO 7 DIN A4 GE	10	1634780000
ESO 7 P DIN A4 GE	10	1670400000
ESO 7 P DIN A4 WS	10	1670390000
STR 7 F.SCHT 7	20	0515300000

**Technical drawing / application**





# Transparent sleeves

## Better perspective for cables and wires

### The right sleeves for flexible applications

The TM sleeves made out of PVC or halogen-free material are almost free from contaminants. The sleeves are a precisely-made markers for wires and cables with an external diameter from 1 to 40 mm. The simple mounting holds firmly to the wire and the sleeves can then be specifically marked using an inlay tag in the MultiCard format. Thanks to the slim design in five different lengths, the TM sleeves can be quickly and safely mounted even in compact cabinet systems.

### TM/HF sleeves – the benefits to you

- Versatile: Different sizes and lengths for a large variety of applications
- Safe: Firm hold on all common cables and wires
- Flexible: Labelling with the inlay tag in the MultiCard format

Environmentally friendly: TM/HF sleeves are free of halogen and, in the case of fire, do not cause corrosive or toxic gasses. Therefore as they are almost free from contaminants, the markers meet the highest safety requirements.

CLI T sleeves are not suited for labelling with P-Ink or STI pen in connection with TM-I MultiCard.



A marker for a wide variety areas application – with the TM sleeves you will always have a precise marker.

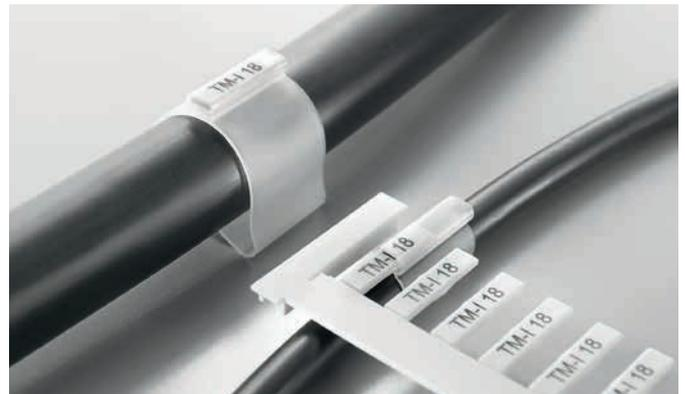

The TM sleeves are particularly suitable for outside applications, thanks to the protected insertion element.

## TM/HF

## Technical data

Material	Temperature range	Fire class acc. to UL 94	Colour
Polyethylene LD	-40 °C...80 °C	HB	Transparent

## Ordering data

Order No.	Type	Height	Wire O.D.	Connection cross-section	Qty.
1719760000	TM 0/12 HF/HB	12 mm	1.3 - 2 mm	0.22 - 0.5 mm <sup>2</sup>	1000
1719770000	TM 0/18 HF/HB	18 mm	1.3 - 2 mm	0.22 - 0.5 mm <sup>2</sup>	1000
1719780000	TM 1/12 HF/HB	12 mm	1.8 - 2.5 mm	0.5 - 1.5 mm <sup>2</sup>	1000
1719790000	TM 1/18 HF/HB	18 mm	1.8 - 2.5 mm	0.5 - 1.5 mm <sup>2</sup>	1000
1719800000	TM 2/12 HF/HB	12 mm	2.5 - 4 mm	0.75 - 2.5 mm <sup>2</sup>	1000
1719810000	TM 2/18 HF/HB	18 mm	2.5 - 4 mm	0.75 - 2.5 mm <sup>2</sup>	1000
1719820000	TM 3/12 HF/HB	12 mm	4 - 6.5 mm	2.5 - 6 mm <sup>2</sup>	500
1719830000	TM 3/18 HF/HB	18 mm	4 - 6.5 mm	2.5 - 6 mm <sup>2</sup>	500
1719840000	TM 4/12 HF/HB	12 mm	6 - 10 mm	10 - 35 mm <sup>2</sup>	500
1719850000	TM 4/18 HF/HB	18 mm	6 - 10 mm	10 - 35 mm <sup>2</sup>	500
1719860000	TM 5/12 HF/HB	12 mm	9 - 15 mm	25 - 70 mm <sup>2</sup>	200
1719870000	TM 5/18 HF/HB	18 mm	9 - 15 mm	25 - 70 mm <sup>2</sup>	200
1719880000	TM 6/12 HF/HB	12 mm	15 - 24 mm	35 - 150 mm <sup>2</sup>	200
1719890000	TM 6/18 HF/HB	18 mm	15 - 24 mm	35 - 150 mm <sup>2</sup>	200
1192770000	TM 7/18 HF/HB	18 mm	20 - 30 mm	120 - 240 mm <sup>2</sup>	100
1192780000	TM 8/18 HF/HB	18 mm	30 - 35 mm	240 - 300 mm <sup>2</sup>	50
1748820000	TMX 18 HF/HB	18 mm	10 - 317 mm	16 - 150 mm <sup>2</sup>	500

## TM/HF - twin sleeve

## Technical data

Material	Temperature range	Fire class acc. to UL 94	Colour
Polyethylene LD	-40 °C...80 °C	HB	Transparent

## Ordering data

Order No.	Type	Height	Wire O.D.	Connection cross-section	Qty.
1891810000	TM 0/18 TWIN HF/HB	18 mm	1.3 - 2.6 mm	0.22 - 1.5 mm <sup>2</sup>	500
1891780000	TM 1/18 TWIN HF/HB	18 mm	2.4 - 4 mm	1.5 - 2.5 mm <sup>2</sup>	500

## Accessories - MultiCard

## Technical data

Material	Temperature range	Fire class acc. to UL 94	Colour
Polyamide 66	-40 °C...100 °C	V-2	white

## Ordering data

Order No.	Type	Height	Width	Qty.
1718411044	TM-I 12 MC NE WS	12 mm	4 mm	320
1718431044	TM-I 18 MC NE WS	18 mm	4 mm	320

## Accessories - MultiMark

## Technical data

Material	Temperature range	Fire class acc. to UL 94	Colour
Polyester	-40 °C...150 °C	HB	white

## Ordering data

Order No.	Type	Height	Width	Qty.
2005440000	TM-I 12 MM WS	12 mm	4 mm	2000
2005470000	TM-I 18 MM WS	18 mm	4 mm	2000



## Transparent sleeves

## CLIT

## Technical data

Material	Temperature range	Fire class acc. to UL 94	Colour
PVC	-30 °C...80 °C	V-0	Transparent

## Ordering data

Order No.	Type	Height	Wire O.D.	Connection cross-section	Qty.
1764060000	CLIT 02-12	12 mm	1.3 - 3 mm	0.22 - 1.5 mm <sup>2</sup>	200
1764070000	CLIT 02-15	15 mm	1.3 - 3 mm	0.22 - 1.5 mm <sup>2</sup>	200
1764140000	CLIT 02-18	18 mm	1.3 - 3 mm	0.22 - 1.5 mm <sup>2</sup>	200
1764150000	CLIT 02-20	20 mm	1.3 - 3 mm	0.22 - 1.5 mm <sup>2</sup>	200
1889580000	CLIT 02-30	30 mm	1.3 - 3 mm	0.22 - 1.5 mm <sup>2</sup>	200
1764190000	CLIT 1-12	12 mm	2.5 - 5 mm	0.75 - 6 mm <sup>2</sup>	200
1764200000	CLIT 1-15	15 mm	2.5 - 5 mm	0.75 - 6 mm <sup>2</sup>	200
1764210000	CLIT 1-18	18 mm	2.5 - 5 mm	0.75 - 6 mm <sup>2</sup>	200
1764220000	CLIT 1-20	20 mm	2.5 - 5 mm	0.75 - 6 mm <sup>2</sup>	200
1889560000	CLIT 1-30	30 mm	2.5 - 5 mm	0.75 - 6 mm <sup>2</sup>	200
1764230000	CLIT 2-12	12 mm	4 - 10 mm	4 - 35 mm <sup>2</sup>	100
1764240000	CLIT 2-15	15 mm	4 - 10 mm	4 - 35 mm <sup>2</sup>	100
1764250000	CLIT 2-18	18 mm	4 - 10 mm	4 - 35 mm <sup>2</sup>	100
1764260000	CLIT 2-20	20 mm	4 - 10 mm	4 - 35 mm <sup>2</sup>	100
1889570000	CLIT 2-30	30 mm	4 - 10 mm	4 - 35 mm <sup>2</sup>	100
1764270000	CLIT 3-12	12 mm	8 - 16 mm	25 - 75 mm <sup>2</sup>	100
1764280000	CLIT 3-15	15 mm	8 - 16 mm	25 - 75 mm <sup>2</sup>	100
1764290000	CLIT 3-18	18 mm	8 - 16 mm	25 - 75 mm <sup>2</sup>	100
1764300000	CLIT 3-20	20 mm	8 - 16 mm	25 - 75 mm <sup>2</sup>	100
1889550000	CLIT 3-30	30 mm	8 - 16 mm	25 - 75 mm <sup>2</sup>	100



## Accessories - MultiCard

## Technical data

Material	Temperature range	Fire class acc. to UL 94	Colour
Polyamide 66	-40 °C...100 °C	V-2	white

## Ordering data

Order No.	Type	Height	Width	Qty.
1718411044	TM-I 12 MC NE WS	12 mm	4 mm	320
1609981044	TM-I 15 MC NE WS	15 mm	4 mm	400
1718431044	TM-I 18 MC NE WS	18 mm	4 mm	320
1680411044	TM-I 20 MC NE WS	20 mm	4 mm	400
1876390000	TM-I 30 MC NE WS	30 mm	4 mm	300

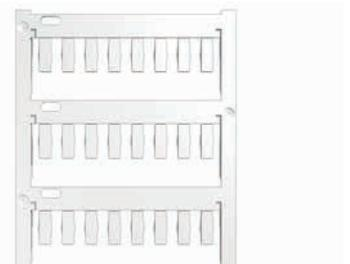

## Accessories - MultiMark

## Technical data

Material	Temperature range	Fire class acc. to UL 94	Colour
Polyester	-40 °C...150 °C	HB	white

## Ordering data

Order No.	Type	Height	Width	Qty.
2005440000	TM-I 12 MM WS	12 mm	4 mm	2000
2005450000	TM-I 15 MM WS	15 mm	4 mm	2000
2005470000	TM-I 18 MM WS	18 mm	4 mm	2000
2005490000	TM-I 20 MM WS	20 mm	4 mm	2000
2005530000	TM-I 30 MM WS	30 mm	4 mm	2000



## CLI T TM sleeve

## Technical data

Material	Temperature range	Fire class acc. to UL 94	Colour
PVC	-30 °C...60 °C	V-0	Transparent

## Ordering data

Order No.	Type	Height	Width	Qty.
1763270000	CLI TM 10-33	33 mm	6 mm	100
1763280000	CLI TM 20-33	33 mm	11.3 mm	100
1763390000	CLI TM 20-66	66 mm	11.3 mm	50

## Accessories

Order No.	Type	Height	Width	Number	Qty.
1600740000	CLI F 1-20 WS/GE	20 mm	4 mm	594	10
1764050000	CLI F 2-17.5 WS/GE	17.5 mm	9 mm	352	10
1718431044	TM-H 18 MC NE WS	18 mm	4 mm	64	320
1674760000	ESG 9/17 K MC NE WS	9 mm	17 mm	40	200
1631920000	ESO 5 S DIN A4 WS	40 mm	7 mm	140	10

## TM sleeve

## Technical data

Material	Temperature range	Fire class acc. to UL 94	Colour
PVC	-40 °C...80 °C	V-0	Transparent

## Ordering data

Order No.	Type	Height	Wire O.D.	Connection cross-section	Qty.
1798650000	TM 200/15 V0	15 mm	1 - 1.5 mm	0.22 - 1 mm <sup>2</sup>	1000
1798640000	TM 201/12 V0	12 mm	1.5 - 2.5 mm	0.25 - 1.5 mm <sup>2</sup>	1000
1798620000	TM 201/15 V0	15 mm	1.5 - 2.5 mm	0.25 - 1.5 mm <sup>2</sup>	1000
1798600000	TM 201/18 V0	18 mm	1.5 - 2.5 mm	0.25 - 1.5 mm <sup>2</sup>	1000
1798580000	TM 201/20 V0	20 mm	1.5 - 2.5 mm	0.25 - 1.5 mm <sup>2</sup>	1000
1507060000	TM 201/23 V0	23 mm	1.5 - 2.5 mm	0.25 - 1.5 mm <sup>2</sup>	1000
1874850000	TM 201/30 V0	30 mm	1.5 - 2.5 mm	0.25 - 1.5 mm <sup>2</sup>	500
1798560000	TM 202/12 V0	12 mm	2 - 4 mm	0.5 - 2.5 mm <sup>2</sup>	1000
1798540000	TM 202/15 V0	15 mm	2 - 4 mm	0.5 - 2.5 mm <sup>2</sup>	1000
1798530000	TM 202/18 V0	18 mm	2 - 4 mm	0.5 - 2.5 mm <sup>2</sup>	1000
1798520000	TM 202/20 V0	20 mm	2 - 4 mm	0.5 - 2.5 mm <sup>2</sup>	1000
1507070000	TM 202/23 V0	23 mm	2 - 4 mm	0.5 - 2.5 mm <sup>2</sup>	1000
1874760000	TM 202/30 V0	30 mm	2 - 4 mm	0.5 - 2.5 mm <sup>2</sup>	500
1798510000	TM 203/12 V0	12 mm	4 - 6 mm	2.5 - 10 mm <sup>2</sup>	500
1798490000	TM 203/15 V0	15 mm	4 - 6 mm	2.5 - 10 mm <sup>2</sup>	500
1798480000	TM 203/18 V0	18 mm	4 - 6 mm	2.5 - 10 mm <sup>2</sup>	500
1798470000	TM 203/20 V0	20 mm	4 - 6 mm	2.5 - 10 mm <sup>2</sup>	500
1507080000	TM 203/23 V0	23 mm	4 - 6 mm	2.5 - 10 mm <sup>2</sup>	500
1874770000	TM 203/30 V0	30 mm	4 - 6 mm	2.5 - 10 mm <sup>2</sup>	200
1806180000	TM 204/12 V0	12 mm	6 - 10 mm	6 - 16 mm <sup>2</sup>	500
1806240000	TM 204/15 V0	15 mm	6 - 10 mm	6 - 16 mm <sup>2</sup>	500
1806300000	TM 204/18 V0	18 mm	6 - 10 mm	6 - 16 mm <sup>2</sup>	500
1806360000	TM 204/20 V0	20 mm	6 - 10 mm	6 - 16 mm <sup>2</sup>	500
1507090000	TM 204/23 V0	23 mm	6 - 10 mm	6 - 16 mm <sup>2</sup>	500
1874780000	TM 204/30 V0	30 mm	6 - 10 mm	6 - 16 mm <sup>2</sup>	200
1806190000	TM 205/12 V0	12 mm	10 - 14 mm	16 - 35 mm <sup>2</sup>	200
1806250000	TM 205/15 V0	15 mm	10 - 14 mm	16 - 35 mm <sup>2</sup>	200
1806310000	TM 205/18 V0	18 mm	10 - 14 mm	16 - 35 mm <sup>2</sup>	200
1806370000	TM 205/20 V0	20 mm	10 - 14 mm	16 - 35 mm <sup>2</sup>	200
1507100000	TM 205/23 V0	23 mm	10 - 14 mm	16 - 35 mm <sup>2</sup>	200
1874790000	TM 205/30 V0	30 mm	10 - 14 mm	16 - 35 mm <sup>2</sup>	200
1806200000	TM 206/12 V0	12 mm	14 - 22 mm	35 - 120 mm <sup>2</sup>	200
1806260000	TM 206/15 V0	15 mm	14 - 22 mm	35 - 120 mm <sup>2</sup>	200
1806320000	TM 206/18 V0	18 mm	14 - 22 mm	35 - 120 mm <sup>2</sup>	200
1806380000	TM 206/20 V0	20 mm	14 - 22 mm	35 - 120 mm <sup>2</sup>	200
1507110000	TM 206/23 V0	23 mm	14 - 22 mm	35 - 120 mm <sup>2</sup>	200
1874800000	TM 206/30 V0	30 mm	14 - 22 mm	35 - 120 mm <sup>2</sup>	100
1866680000	TMX 30 V0	30 mm	10 - 317 mm	16 - 150 mm <sup>2</sup>	400
1724790000	TMC 9/20	20 mm	10 - 317 mm	16 - 150 mm <sup>2</sup>	240



**Transparent sleeves**

**Accessories - MultiCard**

**Technical data**

Material	Temperature range	Fire class acc. to UL 94	Colour
Polyamide 66	-40 °C...100 °C	V-2	white

**Ordering data**

Order No.	Type	Height	Width	Qty.
1718411044	TM-I 12 MC NE WS	12 mm	4 mm	320
1609981044	TM-I 15 MC NE WS	15 mm	4 mm	400
1718431044	TM-I 18 MC NE WS	18 mm	4 mm	320
1680411044	TM-I 20 MC NE WS	20 mm	4 mm	400
1428480000	TM-I 23 MC NE WS	23 mm	4 mm	400
1876390000	TM-I 30 MC NE WS	30 mm	4 mm	300

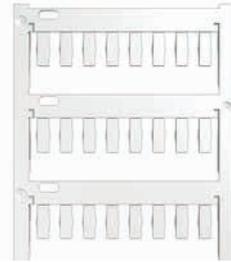

**Accessories - MultiMark**

**Technical data**

Material	Temperature range	Fire class acc. to UL 94	Colour
Polyester	-40 °C...150 °C	HB	white

**Ordering data**

Order No.	Type	Height	Width	Qty.
2005440000	TM-I 12 MM WS	12 mm	4 mm	2000
2005450000	TM-I 15 MM WS	15 mm	4 mm	2000
2005470000	TM-I 18 MM WS	18 mm	4 mm	2000
2005490000	TM-I 20 MM WS	20 mm	4 mm	2000
2005530000	TM-I 30 MM WS	30 mm	4 mm	2000
2005510000	TM-I 23 MM WS	23 mm	4 mm	2000







## WKM – Cable marker

### Firm hold for all cable diameters

#### The robust label holder for cable tie assembly

The halogen-free WKM transparent pocket gives excellent protection against outside influences. Thanks to its secure cable-tie lock-in ability, it is suitable for almost all conductor cross sections.

The previously marked tags are simply placed in the WKH holder and secured with the closing clip. The WKM cable marker is the right solution when it comes to being highly efficient at the labelling site.

#### WKM cable marker – the benefits to you

- Individual labelling of paper and polyester labels can take place using a normal office printer
- The robust design in conjunction with the MultiCard tags guarantees excellent protection against outside influences



Paper and polyester labels  
The following options are available:  
WKM 8/20 + ESO 8/20  
WKM 8/30 + ESO 7  
WKM 18/43 + ESO 5



MultiCard marker  
The following options are available:  
WKM 8/20 + ESG 7/20  
WKM 8/30 + ELS 6/30  
WKM 18/43 + ELS 16/40



The cable tie assembly offers secure attachment for almost all conductor cross sections and high durability, especially under high mechanical demand.



#### Technical data

Material	Polypropylene
UL 94 flammability rating	HB
Min. temperature, continuous	- 40 °C
Max. temperature, continuous	80 °C
Material colour	transparent

WKM

WKM 8/20

8 mm

WKM 8/30

8 mm



Technical data

Material
Fire class acc. to UL 94
Ambient temperature (operational)
Application/manufacturer
Width
Height
Note

Polypropylene
HB
-40 °C...80 °C
Wire and cable markers
8 mm
20 mm

Polypropylene
HB
-40 °C...80 °C
Wire and cable markers
8 mm
30 mm

Ordering data

Transparent
Note

Type	Qty.	Order No.
WKM 8/20	50	1753490000

Type	Qty.	Order No.
WKM 8/30	50	1631910000

Accessories

MultiCard
MultiMark
DIN A4 sheets
Note

Type	Qty.	Order No.
ESG 7/20 SIRIUS MC NE WS	200	1736181044
ESG 7/20 SIRIUS MC NE TU	200	1736181696
ESG 7/20 SIRIUS MC NE GE	200	1736181687
ELS 8/20 MM GE	3000	2005240000
ELS 8/20 MM WS	3000	2005180000
ESD 8/20 DIN A4 GE	10	1919900000
ESD 8/20 P DIN A4 WS	10	1919870000
ESD 8/20 P DIN A4 GE	10	1919880000
ESD 8/20 DIN A4 WS	10	1919890000

Type	Qty.	Order No.
ESG 7/20 SIRIUS MC NE WS	200	1736181044
ELS 6/30 MC NE GE	80	1045580000
ELS 6/30 MC NE WS	80	1045570000
ELS 6/30 MM GE	3000	2010620000
ELS 6/30 MM WS	3000	2009980000
THM ESO 7 PA WS	1	1339570000
THM ESO 7 PA GE	1	1339580000
ESO 7 DIN A4 WS	10	1607720000
ESO 7 P DIN A4 GE	10	1670400000
ESO 7 P DIN A4 WS	10	1670390000
ESO 7 DIN A4 GE	10	1634780000

Technical drawing / application



WKM

WKM 18/43

18 mm



**Technical data**

Material	Polypropylene
Fire class acc. to UL 94	HB
Ambient temperature (operational)	-40 °C...80 °C
Application/manufacturer	Wire and cable markers
Width	18 mm
Height	43 mm
Note	

Material	Polypropylene
Fire class acc. to UL 94	HB
Ambient temperature (operational)	-40 °C...80 °C
Application/manufacturer	Wire and cable markers
Width	18 mm
Height	43 mm
Note	

**Ordering data**

Transparent	
Note	

Type	Qty.	Order No.
WKM 18/43	50	1610700000

**Accessories**

MultiCard	
-----------	--

Type	Qty.	Order No.
ELS 16/40 MC NE GE	40	1045630000
ELS 16/40 MC NE WS	40	1045620000

MultiMark	
-----------	--

ELS 16/40 MM GE	2000	2005260000
ELS 16/40 MM WS	2000	2005200000

DIN A4 sheets	
---------------	--

Paper	ESO 5 DIN A4 WS	10	1607710000
Polyester	ESO 5 P DIN A4 WS	10	1670370000
Polyester	ESO 5 P DIN A4 GE	10	1670380000
Paper	ESO 5 DIN A4 GE	10	1631350000

Note	
------	--

**Technical drawing / application**





# Tag rails

## Boundless freedom of design

### High-contrast identification for side-by-side devices

The SCHS shielding rail can be fitted to almost any device, either glued or screwed. It is the preferred choice for high contrast labelling, especially for devices placed side by side. Some types of sturdy PVC rails have markers that can be clicked and locked into position. You therefore benefit from the large variety and the compatibility of the tag rails from our MultiCard product line. Take advantage of our innovative labelling systems, which is an alternative to engraving.

### Tag rails – the benefits to you

- Additional information to the equipment is easy to correlate
- Depending upon the application, the length can be increased because of the metre lengths that are delivered



The SCHS shielding rail can be fitted to almost any device, either glued or screwed, which makes it usable almost anywhere.



With the normal width size of 17.5 mm, as is the case with circuit breakers, the tag rail SchS2 is recommended along with the device marker ESG 8/17S.

### Technical data

Material	Hard PVC
Flammability classification to UL 94	VO
Temp., min.	-20 °C
Temp., max.	80 °C



Tag rails

SCHS 2

8 mm

SCHS 2 K

8 mm



Technical data

Material
Fire class acc. to UL 94
Ambient temperature (operational)
Application/manufacturer
Width
Height
Note

PVC
V-0
-20 °C...80 °C
8 mm
1000 mm

PVC
V-0
-20 °C...80 °C
Self-adhesive
8 mm
1000 mm

Ordering data

black	●
grey	●
Note	

Type	Qty.	Order No.
SCHS2	1	0337400000

Type	Qty.	Order No.
SCHS 2 K	1	1720600000

Accessories

MultiCard
MultiMark
Note

Type	Qty.	Order No.
ESG 8/17 SCHS MC NE WS	200	1720610000
DEK 5/5 MC NE WS	1000	1609801044
WS 8/5 MC NE WS	720	1640740000
DEK 5/5 MM WS	800	2007110000
WS 8/5 MM WS	800	2007150000

Type	Qty.	Order No.
ESG 8/17 SCHS MC NE WS	200	1720610000
DEK 5/5 MC NE WS	1000	1609801044
WS 8/5 MC NE WS	720	1640740000
DEK 5/5 MM WS	800	2007110000
WS 8/5 MM WS	800	2007150000

Technical drawing / application



Tag rails

SCHS 3 + SCHS 4

10 mm



Technical data

Material	PVC
Fire class acc. to UL 94	V-0
Ambient temperature (operational)	-20 °C...80 °C
Application/manufacturer	Self-adhesive
Width	10 mm
Height	1000 mm
Note	

Ordering data

black	●
grey	●
Note	

Type	Qty.	Order No.
SCHS3 K	1	1753480000
SCHS4 K	1	1753460000

Accessories

MultiCard	
MultiMark	
Note	

Type	Qty.	Order No.
ESG 7/20 SIRIUS MC NE GE	200	1736181687

Technical drawing / application

--	--



# Cabinet Infrastructure

<b>Cabinet Infrastructure</b>	Filter fans	G.2
	Heating solutions	G.10
	Thermostats and humidistats	G.14
	Cable ducts	G.17
	Accessories cable ducts	G.25
	Cable ties	G.30

# Modern thermal management for your control cabinet infrastructure

## Filter fans from Weidmüller

### Thermal Management with WI filter fans

Growing trends in digitalisation increase the proportion of active electronic components in control cabinets, resulting in more heat generation within. Our filter fans enable an efficient heat extraction and thus increase the life expectancy of your electronic components.

Due to their low energy consumption at high air flow rates, our filter fans ensure a reliable and economical cooling of your control cabinet. The combination of filter mat and gasket meets the high protection classes IP54 and IP55 even at constant high flow rates. Additionally, the innovative folded filter mat lasts 3 times as long as conventional products due to its larger surface area. Sophisticated details such as the snap mechanism on all four corners or the functional flap cover allow a quick, tool-free assembly, saving time and money.

Weidmüller's Thermal Management products are an important addition for your control cabinet infrastructure.



### Filter fans



### The perfect combination of filter fans and thermostats

By combining a filter fan with a thermostat, you will save energy, material and time. The thermostat controls when the filter fan is used. This reduces energy consumption and extends the life of the fan significantly. At the same time, filter mats need to be cleaned or replaced less frequently, which reduces maintenance costs. You optimize your environmental balance, reduce your costs and improve reliability in your production process.

### Heaters, thermostats and humidistat

Heaters for control cabinets, in combination with thermostats and humidistat, ensure pinpoint heat distribution and safe temperatures above the dew point. The use of thermostats and humidistat leads to energy savings and, thus, to a better environmental balance. By avoiding the hazards of condensation your production process will run reliably.

### Heat



### Control: Thermostats, Humidistat



# The right solution for every cooling challenge

## Filter fans from Weidmüller

The practical challenges are wide ranging. That's why we provide you with a broad portfolio of filter fans for different applications and installation locations. With various sizes, a wide range of protection classes, and products for EMC-sensitive areas, we have the right fan for you.



**Indoor filter fan IP54**

The closed frame prevents ingress of unfiltered air according to IP54. Available in grey (RAL 7035) and black (RAL 9011) as standard.



**Outdoor filter fan IP55**

For both indoor and outdoor use with innovative filter mat technology to ensure outstanding air-flow performance. The specially chosen plastic ensures high UV protection.



**EMC filter fan IP54**

For use near electromagnetic fields. Secure contact surface without the need for a beryllium copper seal and particularly environmentally friendly as no metal reinforced plastics are required.



**Slim-Line outdoor filter fan**

Optimised design for compact cabinets where space is a premium. Suitable for indoor and outdoor use due to IP55 protection and the use of UV-resistant plastic.



**Roof filter fans**

Ideal for indoor use in tight spaces. Optimised air flow and temperature distribution, protection according to IP33 or IP54 and high UV resistance.

## Filter fans

## Filter fans



## Technical data

<b>Voltage supply</b>	<b>Operating temperature range</b>
230 V AC	-40...55 °C

## Ordering data

Order No.	Type	Volume flow, free-blowing at 50 Hz	Protection degree	Colour	Width/Height	Width of installation cut-outs/height	Mounting depth/height	MTBF	Qty.
2556590000	FF 11 54/230V BK	19.00 m³/h	IP54	black	109 / 109 mm	92 / 92 mm	62 / 4 mm	52500 h	1
2556690000	FF 11 54/230V GY	19.00 m³/h	IP54	grey	109 / 109 mm	92 / 92 mm	62 / 4 mm	52500 h	1
2556630000	FF 22 54/230V BK	61.00 m³/h	IP54	black	145 / 145 mm	125 / 125 mm	70 / 5 mm	37500 h	1
2556620000	FF 22 54/230V GY	61.00 m³/h	IP54	grey	145 / 145 mm	125 / 125 mm	70 / 5 mm	37500 h	1
2556650000	FF 22 55/230V BK	56.00 m³/h	IP55	black	145 / 145 mm	125 / 125 mm	70 / 5 mm	37500 h	1
2556640000	FF 22 55/230V GY	56.00 m³/h	IP55	grey	145 / 145 mm	125 / 125 mm	70 / 5 mm	37500 h	1
2556690000	FF 32 54/230V BK	98.00 m³/h	IP54	black	202 / 202 mm	177 / 177 mm	87 / 6 mm	37500 h	1
2556680000	FF 32 54/230V GY	98.00 m³/h	IP54	grey	202 / 202 mm	177 / 177 mm	87 / 6 mm	37500 h	1
2556710000	FF 32 55/230V BK	100.00 m³/h	IP55	black	202 / 202 mm	177 / 177 mm	87 / 6 mm	37500 h	1
2556700000	FF 32 55/230V GY	100.00 m³/h	IP55	grey	202 / 202 mm	177 / 177 mm	87 / 6 mm	37500 h	1
2556760000	FF 42 54/230V BK	125.00 m³/h	IP54	black	252 / 252 mm	223 / 223 mm	97 / 6 mm	40000 h	1
2556750000	FF 42 54/230V GY	125.00 m³/h	IP54	grey	252 / 252 mm	223 / 223 mm	97 / 6 mm	40000 h	1
2556780000	FF 42 55/230V BK	145.00 m³/h	IP55	black	252 / 252 mm	223 / 223 mm	97 / 6 mm	40000 h	1
2556770000	FF 42 55/230V GY	145.00 m³/h	IP55	grey	252 / 252 mm	223 / 223 mm	97 / 6 mm	40000 h	1
2556830000	FF 43 54/230V BK	223.00 m³/h	IP54	black	252 / 252 mm	223 / 223 mm	113 / 6 mm	40000 h	1
2556820000	FF 43 54/230V GY	223.00 m³/h	IP54	grey	252 / 252 mm	223 / 223 mm	113 / 6 mm	40000 h	1
2556850000	FF 43 55/230V BK	233.00 m³/h	IP55	black	252 / 252 mm	223 / 223 mm	113 / 6 mm	40000 h	1
2556840000	FF 43 55/230V GY	233.00 m³/h	IP55	grey	252 / 252 mm	223 / 223 mm	113 / 6 mm	40000 h	1
2556880000	FF 65 54/230V BK	480.00 m³/h	IP54	black	320 / 320 mm	291 / 291 mm	150 / 7 mm	40000 h	1
2556870000	FF 65 54/230V GY	480.00 m³/h	IP54	grey	320 / 320 mm	291 / 291 mm	150 / 7 mm	40000 h	1
2556900000	FF 65 55/230V BK	505.00 m³/h	IP55	black	320 / 320 mm	291 / 291 mm	150 / 7 mm	40000 h	1
2556890000	FF 65 55/230V GY	505.00 m³/h	IP55	grey	320 / 320 mm	291 / 291 mm	150 / 7 mm	40000 h	1
2556920000	FF 66 54/230V BK	640.00 m³/h	IP54	black	320 / 320 mm	291 / 291 mm	150 / 7 mm	40000 h	1
2556910000	FF 66 54/230V GY	640.00 m³/h	IP54	grey	320 / 320 mm	291 / 291 mm	150 / 7 mm	40000 h	1
2556940000	FF 66 55/230V BK	770.00 m³/h	IP55	black	320 / 320 mm	291 / 291 mm	150 / 7 mm	40000 h	1
2556930000	FF 66 55/230V GY	770.00 m³/h	IP55	grey	320 / 320 mm	291 / 291 mm	150 / 7 mm	40000 h	1
2556960000	FF 67 54/230V BK	845.00 m³/h	IP54	black	320 / 320 mm	291 / 291 mm	150 / 7 mm	40000 h	1
2556950000	FF 67 54/230V GY	845.00 m³/h	IP54	grey	320 / 320 mm	291 / 291 mm	150 / 7 mm	40000 h	1
2556980000	FF 67 55/230V BK	925.00 m³/h	IP55	black	320 / 320 mm	291 / 291 mm	150 / 7 mm	40000 h	1
2556970000	FF 67 55/230V GY	925.00 m³/h	IP55	grey	320 / 320 mm	291 / 291 mm	150 / 7 mm	40000 h	1

## Exhaust filter



## Technical data

Operating temperature range  
-40...55 °C

## Ordering data

Order No.	Type	Protection degree	Colour	Width / Height	Width of installation cut-outs/height	Mounting depth/height	Qty.
2557070000	EF 10 54 GY	IP54	grey	109 / 109 mm	92 / 92 mm	19 / 4 mm	1
2557080000	EF 10 54 BK	IP54	black	109 / 109 mm	92 / 92 mm	19 / 4 mm	1
2557090000	EF 20 54 GY	IP54	grey	145 / 145 mm	125 / 125 mm	26 / 5 mm	1
2557100000	EF 20 54 BK	IP54	black	145 / 145 mm	125 / 125 mm	26 / 5 mm	1
2557110000	EF 20 55 GY	IP55	grey	145 / 145 mm	125 / 125 mm	26 / 5 mm	1
2557120000	EF 20 55 BK	IP55	black	145 / 145 mm	125 / 125 mm	26 / 5 mm	1
2557130000	EF 30 54 GY	IP54	grey	202 / 202 mm	177 / 177 mm	34 / 6 mm	1
2557140000	EF 30 54 BK	IP54	black	202 / 202 mm	177 / 177 mm	34 / 6 mm	1
2557150000	EF 30 55 GY	IP55	grey	202 / 202 mm	177 / 177 mm	34 / 6 mm	1
2557160000	EF 30 55 BK	IP55	black	202 / 202 mm	177 / 177 mm	34 / 6 mm	1
2557170000	EF 40 54 GY	IP54	grey	252 / 252 mm	223 / 223 mm	38 / 6 mm	1
2557180000	EF 40 54 BK	IP54	black	252 / 252 mm	223 / 223 mm	38 / 6 mm	1
2557190000	EF 40 55 GY	IP55	grey	252 / 252 mm	223 / 223 mm	38 / 6 mm	1
2557200000	EF 40 55 BK	IP55	black	252 / 252 mm	223 / 223 mm	38 / 6 mm	1
2557210000	EF 60 54 GY	IP54	grey	320 / 320 mm	291 / 291 mm	39 / 7 mm	1
2557220000	EF 60 54 BK	IP54	black	320 / 320 mm	291 / 291 mm	39 / 7 mm	1
2557230000	EF 60 55 GY	IP55	grey	320 / 320 mm	291 / 291 mm	39 / 7 mm	1
2557240000	EF 60 55 BK	IP55	black	320 / 320 mm	291 / 291 mm	39 / 7 mm	1

## Filter fans

## Filter fan EMC



## Technical data

<b>Voltage supply</b>	<b>Operating temperature range</b>
230 V AC	-40...55 °C

## Ordering data

Order No.	Type	Volume flow, free-blowing at 50 Hz	Protection degree	Colour	Width / Height	Width of installation cut-outs/height	Mounting depth/height	MTBF	Qty.
2557250000	FF-EMC 11 54/230V GY	25.00 m³/h	IP54	grey	109 / 109 mm	93 / 93 mm	62 / 4 mm	52500 h	1
2557260000	FF-EMC 11 54/230V BK	25.00 m³/h	IP54	black	109 / 109 mm	93 / 93 mm	62 / 4 mm	52500 h	1
2557270000	FF-EMC 22 54/230V GY	61.00 m³/h	IP54	grey	145 / 145 mm	126.5 / 126.5 mm	70 / 5 mm	37500 h	1
2557280000	FF-EMC 22 54/230V BK	61.00 m³/h	IP54	black	145 / 145 mm	126.5 / 126.5 mm	70 / 5 mm	37500 h	1
2557290000	FF-EMC 22 55/230V GY	56.00 m³/h	IP55	grey	145 / 145 mm	126.5 / 126.5 mm	70 / 5 mm	37500 h	1
2557300000	FF-EMC 22 55/230V BK	56.00 m³/h	IP55	black	145 / 145 mm	126.5 / 126.5 mm	70 / 5 mm	37500 h	1
2557310000	FF-EMC 32 54/230V GY	110.00 m³/h	IP54	grey	202 / 202 mm	178 / 178 mm	87 / 6 mm	37500 h	1
2557320000	FF-EMC 32 54/230V BK	110.00 m³/h	IP54	black	202 / 202 mm	178 / 178 mm	87 / 6 mm	37500 h	1
2557330000	FF-EMC 32 55/230V GY	100.00 m³/h	IP55	grey	202 / 202 mm	178 / 178 mm	87 / 6 mm	37500 h	1
2557340000	FF-EMC 32 55/230V BK	100.00 m³/h	IP55	black	202 / 202 mm	178 / 178 mm	87 / 6 mm	37500 h	1
2557350000	FF-EMC 42 54/230V GY	156.00 m³/h	IP54	grey	252 / 252 mm	224 / 224 mm	97 / 6 mm	40000 h	1
2557360000	FF-EMC 42 54/230V BK	156.00 m³/h	IP54	black	252 / 252 mm	224 / 224 mm	97 / 6 mm	40000 h	1
2557370000	FF-EMC 42 55/230V GY	145.00 m³/h	IP55	grey	252 / 252 mm	224 / 224 mm	97 / 6 mm	40000 h	1
2557380000	FF-EMC 42 55/230V BK	145.00 m³/h	IP55	black	252 / 252 mm	224 / 224 mm	97 / 6 mm	40000 h	1
2557390000	FF-EMC 43 54/230V GY	256.00 m³/h	IP54	grey	252 / 252 mm	224 / 224 mm	113 / 6 mm	40000 h	1
2557400000	FF-EMC 43 54/230V BK	256.00 m³/h	IP54	black	252 / 252 mm	224 / 224 mm	113 / 6 mm	40000 h	1
2557410000	FF-EMC 43 55/230V GY	233.00 m³/h	IP55	grey	252 / 252 mm	224 / 224 mm	113 / 6 mm	40000 h	1
2557420000	FF-EMC 43 55/230V BK	233.00 m³/h	IP55	black	252 / 252 mm	224 / 224 mm	113 / 6 mm	40000 h	1
2557430000	FF-EMC 65 54/230V GY	480.00 m³/h	IP54	grey	320 / 320 mm	292 / 292 mm	150 / 7 mm	40000 h	1
2557440000	FF-EMC 65 54/230V BK	480.00 m³/h	IP54	black	320 / 320 mm	292 / 292 mm	150 / 7 mm	40000 h	1
2557450000	FF-EMC 65 55/230V GY	505.00 m³/h	IP55	grey	320 / 320 mm	292 / 292 mm	150 / 7 mm	40000 h	1
2557460000	FF-EMC 65 55/230V BK	505.00 m³/h	IP55	black	320 / 320 mm	292 / 292 mm	150 / 7 mm	40000 h	1
2557470000	FF-EMC 66 54/230V GY	640.00 m³/h	IP54	grey	320 / 320 mm	292 / 292 mm	150 / 7 mm	40000 h	1
2557480000	FF-EMC 66 54/230V BK	640.00 m³/h	IP54	black	320 / 320 mm	292 / 292 mm	150 / 7 mm	40000 h	1
2557490000	FF-EMC 66 55/230V GY	770.00 m³/h	IP55	grey	320 / 320 mm	292 / 292 mm	150 / 7 mm	40000 h	1
2557500000	FF-EMC 66 55/230V BK	770.00 m³/h	IP55	black	320 / 320 mm	292 / 292 mm	150 / 7 mm	40000 h	1
2557510000	FF-EMC 67 54/230V GY	845.00 m³/h	IP54	grey	320 / 320 mm	292 / 292 mm	150 / 7 mm	40000 h	1
2557520000	FF-EMC 67 54/230V BK	845.00 m³/h	IP54	black	320 / 320 mm	292 / 292 mm	150 / 7 mm	40000 h	1
2557530000	FF-EMC 67 55/230V GY	925.00 m³/h	IP55	grey	320 / 320 mm	292 / 292 mm	150 / 7 mm	40000 h	1
2557540000	FF-EMC 67 55/230V BK	925.00 m³/h	IP55	black	320 / 320 mm	292 / 292 mm	150 / 7 mm	40000 h	1



## Exhaust filter EMC



## Technical data

**Operating temperature range**  
-40...55 °C

## Ordering data

Order No.	Type	Protection degree	Colour	Width / Height	Width of installation cut-outs...height	Mounting depth/height	Qty.
2557550000	EF-EMC 10 54 GY	IP54	grey	109 / 109 mm	93...93 mm	19 / 4 mm	1
2557560000	EF-EMC 10 54 BK	IP54	black	109 / 109 mm	93...93 mm	19 / 4 mm	1
2557570000	EF-EMC 20 54 GY	IP54	grey	145 / 145 mm	126.5...126.5 mm	26 / 5 mm	1
2557580000	EF-EMC 20 54 BK	IP54	black	145 / 145 mm	126.5...126.5 mm	26 / 5 mm	1
2557590000	EF-EMC 20 55 GY	IP55	grey	145 / 145 mm	126.5...126.5 mm	26 / 5 mm	1
2557600000	EF-EMC 20 55 BK	IP55	black	145 / 145 mm	126.5...126.5 mm	26 / 5 mm	1
2557610000	EF-EMC 30 54 GY	IP54	grey	202 / 202 mm	178...178 mm	34 / 6 mm	1
2557620000	EF-EMC 30 54 BK	IP54	black	202 / 202 mm	178...178 mm	34 / 6 mm	1
2557630000	EF-EMC 30 55 GY	IP55	grey	202 / 202 mm	178...178 mm	34 / 6 mm	1
2557640000	EF-EMC 30 55 BK	IP55	black	202 / 202 mm	178...178 mm	34 / 6 mm	1
2557650000	EF-EMC 40 54 GY	IP54	grey	252 / 252 mm	224...224 mm	38 / 6 mm	1
2557660000	EF-EMC 40 54 BK	IP54	black	252 / 252 mm	224...224 mm	38 / 6 mm	1
2557670000	EF-EMC 40 55 GY	IP55	grey	252 / 252 mm	224...224 mm	38 / 6 mm	1
2557680000	EF-EMC 40 55 BK	IP55	black	252 / 252 mm	224...224 mm	38 / 6 mm	1
2557690000	EF-EMC 60 54 GY	IP54	grey	320 / 320 mm	292...292 mm	39 / 7 mm	1
2557700000	EF-EMC 60 54 BK	IP54	black	320 / 320 mm	292...292 mm	39 / 7 mm	1
2557710000	EF-EMC 60 55 GY	IP55	grey	320 / 320 mm	292...292 mm	39 / 7 mm	1
2557720000	EF-EMC 60 55 BK	IP55	black	320 / 320 mm	292...292 mm	39 / 7 mm	1

## Filter fan Slim-Line



## Technical data

**Voltage supply** 230 V AC  
**Operating temperature range** -40...55 °C

## Ordering data

Order No.	Type	Volume flow, free-blowing at 50 Hz	Protection degree	Colour	Width / Height	Width of installation cut-outs/height	Mounting depth/height	MTBF	Qty.
2557000000	FF-SL 65 55/230V GY	500.00 m³/h	IP55	grey	320 / 320 mm	291 / 291 mm	124 / 7 mm	40000 h	1
2557010000	FF-SL 65 55/230V BK	500.00 m³/h	IP55	black	320 / 320 mm	291 / 291 mm	124 / 7 mm	40000 h	1
2557030000	FF-SL 67 55/230V GY	705.00 m³/h	IP55	grey	320 / 320 mm	291 / 291 mm	124 / 7 mm	40000 h	1
2557040000	FF-SL 67 55/230V BK	705.00 m³/h	IP55	black	320 / 320 mm	291 / 291 mm	124 / 7 mm	40000 h	1

## Filter fans

## Roof filter fans



## Technical data

<b>Voltage supply</b>	<b>Operating temperature range</b>
230 V AC	-15...55 °C

## Ordering data

Order No.	Type	Volume flow, free-blowing at 50 Hz	Protection degree	Colour	Width / Height	Width of installation cut-outs/height	Mounting depth/height	MTBF	Qty.
2557730000	RFF 605 54/230V GY	350.00 m³/h	IP54	grey	436 / 436 mm	291 / 291 mm	34 / 72 mm	50000 h	1
2557740000	RFF 605 33/230V GY	500.00 m³/h	IP33	grey	436 / 436 mm	291 / 291 mm	34 / 72 mm	50000 h	1
2557770000	RFF 607 54/230V GY	550.00 m³/h	IP54	grey	470 / 470 mm	291 / 291 mm	57 / 95 mm	40000 h	1
2557780000	RFF 607 33/230V GY	700.00 m³/h	IP33	grey	470 / 470 mm	291 / 291 mm	57 / 95 mm	40000 h	1
2557810000	RFF 610 54/230V GY	750.00 m³/h	IP54	grey	470 / 470 mm	291 / 291 mm	57 / 95 mm	40000 h	1
2557820000	RFF 610 33/230V GY	1000.00 m³/h	IP33	grey	470 / 470 mm	291 / 291 mm	57 / 95 mm	40000 h	1

## Roof exhaust filter



## Technical data

<b>Operating temperature range</b>
-15...55 °C

## Ordering data

Order No.	Type	Protection degree	Colour	Width / Height	Width of installation cut-outs/height	Mounting depth/height	Qty.
2557840000	REF 600 54 GY	IP54	grey	436 / 436 mm	291 / 291 mm	34 / 72 mm	1
2557850000	REF 600 33 GY	IP33	grey	436 / 436 mm	291 / 291 mm	34 / 72 mm	1

## Filter mats



## Technical data

**Operating temperature range**  
-40...55 °C

## Ordering data

Order No.	Type	Protection degree	Width / Height	Qty.
255660000	FF-FIMT 11 54	IP54	87 / 87 mm	5
255666000	FF-FIMT 2X 54	IP54	119 / 119 mm	5
255667000	FF-FIMT 2X 55	IP55	116 / 108 mm	5
255672000	FF-FIMT 3X 54	IP54	170 / 170 mm	5
255673000	FF-FIMT 3X 55	IP55	166 / 156 mm	5
255679000	FF-FIMT 4X 54	IP54	216 / 216 mm	5
255680000	FF-FIMT 4X 55	IP55	212 / 200 mm	5
255705000	FF-FIMT 6X 55	IP55	279 / 264 mm	5
256731000	FF-FIMT 6X 54	IP54	284 / 284 mm	5
255775000	RFF-FIMT 605X 54	IP54	290 / 70 mm	20
255779000	RFF-FIMT 607/610 54	IP54	290 / 95 mm	20

# Control Cabinet heating, for when it is cold outside

## Heating solutions from Weidmüller

Large temperature differences can lead to condensation in the control cabinet. To avoid the resulting dangers such as corrosion and short circuits, we offer various radiant heaters and fan heaters to meet all of your requirements.

### Radiant heater

#### Radiant heater RH-CBCO

For localised heating and small heating requirements. Compact form makes it ideal for confined spaces.



#### Radiant heater RH-TCO

Our standard radiant heater for all applications with a wide power range and various connection options. Ideal for confined spaces.



### Compact fan heater

#### Compact fan heater FH-TCO

Our new generation of fan heaters with PTC technology (positive temperature coefficient) are suitable for all applications within the cabinet. Thanks to its particularly fast heating effect, it is ideal for all systems that need to be heated quickly, e.g. in wind power generation. Designed in a robust and compact plastic housing.



#### Compact fan heater FH-TH

The modern PTC fan heater with integrated thermostat and fast heating effect. As no additional thermostat is necessary, an ideal solution for compact cabinets. It comes with automatic temperature control for high energy efficiency and a robust plastic housing.



Radiant heater

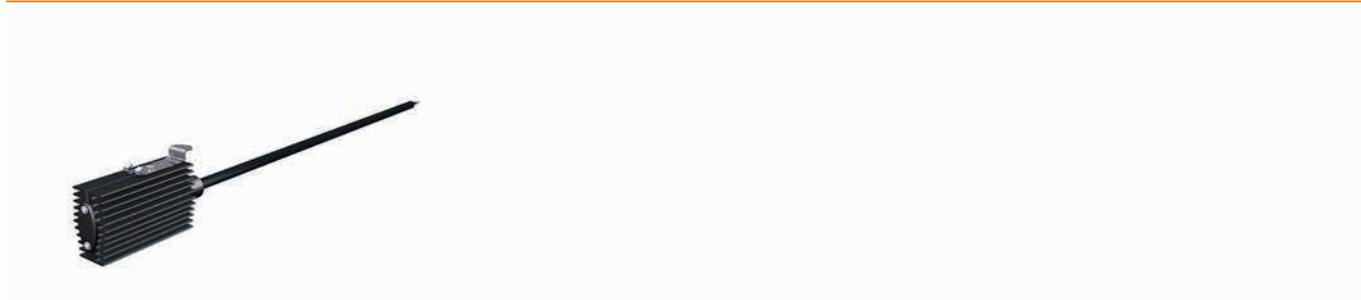

Technical data

Voltage supply	Operating temperature range	Type of mounting	With room thermostat
110 - 230 V AC / 60-50 Hz	-40...70 °C	Rail	No

Ordering data

Order No.	Type	Power	Colour	Type of connection	Width / Height / Depth	Qty.
2557860000	RH-CBCO 10W 110-250V BK	10 W	black	Pre-assembled cable	29,5 / 45 / 75 mm	1
2557870000	RH-CBCO 20W 110-250V BK	20 W	black	Pre-assembled cable	29,5 / 45 / 75 mm	1
2557880000	RH-CBCO 30W 110-250V BK	30 W	black	Pre-assembled cable	29,5 / 45 / 75 mm	1

Radiant heater

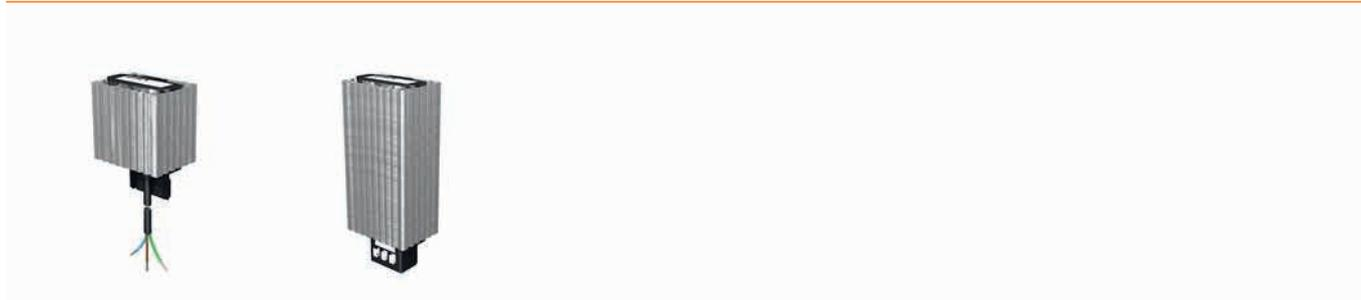

Technical data

Voltage supply	Operating temperature range	Type of mounting	With room thermostat
110 - 230 V AC / 60-50 Hz	-40...70 °C	Rail	No

Ordering data

Order No.	Type	Power	Colour	Type of connection	Width / Height / Depth	Qty.
2557890000	RH-CBCO 30W 110-250V	30 W	silver	Pre-assembled cable	70 / 100 / 50 mm	1
2557900000	RH-CBCO 45W 110-250V	45 W	silver	Pre-assembled cable	70 / 100 / 50 mm	1
2557930000	RH-CBCO 75W 110-250V	75 W	silver	Pre-assembled cable	70 / 175 / 50 mm	1
2557940000	RH-CBCO 100W 110-250V	100 W	silver	Pre-assembled cable	70 / 175 / 50 mm	1
2557950000	RH-CBCO 150W 110-250V	150 W	silver	Pre-assembled cable	70 / 250 / 50 mm	1
2557910000	RH-TCO 30W 110-250V	30 W	silver	Spring contact	70 / 100 / 50 mm	1
2557920000	RH-TCO 45W 110-250V	45 W	silver	Spring contact	70 / 100 / 50 mm	1
2557960000	RH-TCO 75W 110-250V	75 W	silver	Spring contact	70 / 175 / 50 mm	1
2557970000	RH-TCO 100W 110-250V	100 W	silver	Spring contact	70 / 175 / 50 mm	1
2557980000	RH-TCO 150W 110-250V	150 W	silver	Spring contact	70 / 250 / 50 mm	1



Fan heater



Technical data

Voltage supply	Operating temperature range	Type of mounting	With room thermostat
230 V AC	-40...70 °C	Rail	No

Ordering data

Order No.	Type	Power	Colour	Type of connection	Width / Height / Depth	Qty.
2557990000	FH-TCO 250W 230V	250 W	silver	Spring contact	85 / 186.5 / 104 mm	1
2558000000	FH-TCO 400W 230V	400 W	silver	Spring contact	85 / 226.5 / 104 mm	1

Fan heater



Technical data

Voltage supply	Operating temperature range	Type of mounting	With room thermostat
230 V AC	-40...70 °C	Rail, Screw mounting	No

Ordering data

Order No.	Type	Power	Colour	Type of connection	Width / Height / Depth	Qty.
2558010000	FH-TCO 200W 230V BK	200 W	black	Spring contact	88 / 142 / 126 mm	1
2558020000	FH-TCO 300W 230V BK	300 W	black	Spring contact	88 / 142 / 126 mm	1
2558030000	FH-TCO 400W 230V BK	400 W	black	Spring contact	88 / 142 / 126 mm	1
2558040000	FH-TCO 500W 230V BK	500 W	black	Spring contact	88 / 142 / 126 mm	1
2558050000	FH-TCO 650W 230V BK	650 W	black	Spring contact	88 / 142 / 126 mm	1
2558060000	FH-TCO 800W 230V BK	800 W	black	Spring contact	88 / 142 / 126 mm	1
2558070000	FH-TCO 1000W 230V BK	1000 W	black	Spring contact	88 / 142 / 126 mm	1
2558080000	FH-TCO 1200W 230V BK	1200 W	black	Spring contact	88 / 142 / 126 mm	1

Fan heater with thermostat



Technical data

Voltage supply	Operating temperature range	Type of mounting	With room thermostat
230 V AC	-40...70 °C	Rail, Screw mounting	Yes

Ordering data

Order No.	Type	Power	Colour	Type of connection	Width / Height / Depth	Qty.
2558090000	FH-TH 200W 230V BK	200 W	black	Spring contact	88 / 142 / 139 mm	1
2558100000	FH-TH 300W 230V BK	300 W	black	Spring contact	88 / 142 / 139 mm	1
2558110000	FH-TH 400W 230V BK	400 W	black	Spring contact	88 / 142 / 139 mm	1
2558120000	FH-TH 500W 230V BK	500 W	black	Spring contact	88 / 142 / 139 mm	1
2558130000	FH-TH 650W 230V BK	650 W	black	Spring contact	88 / 142 / 139 mm	1
2558140000	FH-TH 800W 230V BK	800 W	black	Spring contact	88 / 142 / 139 mm	1
2558150000	FH-TH 1000W 230V BK	1000 W	black	Spring contact	88 / 142 / 139 mm	1
2558160000	FH-TH 1200W 230V BK	1200 W	black	Spring contact	88 / 142 / 139 mm	1

# Perfectly regulate temperature and humidity

## Thermostats and humidistats from Weidmüller



A good climate in your control cabinet supports a safe and reliable operation of all your installed components. To make the control and regulation of temperature or humidity as easy as possible, we offer you our thermostats and humidistats.



### Compact Fan Heater

#### Thermostat THSW

Our standard solution for heater and filter fan control. Provides protection for heating systems and helps to save energy. Suitable for all industrial applications.



### Twin Thermostat

#### Twin Thermostat THSA

Space-saving combination for simultaneous switching of two devices in different temperature ranges. Suitable for all industrial applications.



### Humidistat

#### Humidistat HYSA

Humidity control and condensation protection, especially in high humidity environments. Suitable for all industrial applications.



## Thermostats



## Technical data

Operating temperature range	Type of connection	Type of mounting
-20...80 °C	Screw connection	Rail

## Ordering data

Order No.	Type	Switching difference	Switching tolerance	Switching current, NO/NC contact	Switching current cos φ = 0.6	Qty.
2558170000	THSW 1K -20°+40°C CO	1 K	±3 K	10 A / 5 A	2 A / 2 A	1
2558180000	THSW 3K -20°+40°C CO	3 K	±3 K	10 A / 5 A	2 A / 2 A	1
2558190000	THSW 1K 0°+60°C CO	1 K	±3 K	10 A / 5 A	2 A / 2 A	1
2558200000	THSW 3K 0°+60°C CO	3 K	±3 K	10 A / 5 A	2 A / 2 A	1
2558210000	THSW -20°+40°C NC	<7 K	±4 K	10 A /	2 A /	1
2558220000	THSW -20°+40°C NO	<7 K	±4 K	10 A	2 A	1
2558230000	THSW 0°+60°C NC	<7 K	±4 K	10 A /	2 A /	1
2558240000	THSW 0°+60°C NO	<7 K	±4 K	10 A	2 A	1

## Twin thermostats



## Technical data

Operating temperature range	Type of connection	Type of mounting
-20...80 °C	Screw connection	Rail

## Ordering data

Order No.	Type	Switching difference	Switching tolerance	Switching current, NO/NC contact	Switching current cos φ = 0.6	Qty.
2558250000	THSW 0°+60°C NO/NC	<7 K	±4 K	10 A / 10 A	2 A / 2 A	1
2558260000	THSW 0°+60°C NO/NO	<7 K	±4 K	10 A / 10 A	2 A / 2 A	1

## Thermostats and humidistat

## Humidistat



## Technical data

Operating temperature range	Type of connection	Type of mounting
0.01...60 °C	Screw connection	Rail

## Ordering data

Order No.	Type	Adjustable threshold for rel. humidity	Switching current, NO/NC contact	Switching difference	Switching current cos $\varphi = 0.6$	Qty.
2558270000	HYSW 40-90% R.F. CO	40 % / 90 %	2 A / 5 A	5 %	0.2 A / 0.2 A	1

## Humidistat with thermostat



## Technical data

Operating temperature range	Type of connection	Type of mounting
-20...60 °C	Screw connection	Rail

## Ordering data

Order No.	Type	Adjustable threshold for rel. humidity	Switching current, NO/NC contact	Switching difference	Switching current cos $\varphi = 0.6$	Qty.
2558280000	HYTH-SW 40-90% R.F. CO	40 % / 90 %	8 A / 8 A	4 %, 1 K	3 A / 3 A	1

# Incorporate the structures for flexibility within the cabinet

## Cable ducts as the basis for ordered cable routing

### Additional Structure brings Added Value

Increasing trends in digitalisation require higher packing densities in the cabinet. To maintain order within the cabinet, a clear and space-saving cable routing system is required. This is more than just an optical aspect, because orderly cable routing saves time and money. It facilitates maintenance and repair work and increases general operational safety.

As a partner for Industrial Connectivity, we know the challenges faced and provide you with a comprehensive range of cable ducts and accessories for all applications. Practical details like wire holding lugs for the fixing of already installed wires, as well as precisely punched holes according to DIN EN 50085-2-3, facilitate accurate installation. The clever closing mechanism allows easy latching and ensures a secure fit when closing the lid.

Together, we create sustainable structures with added value. We support you in all work steps from planning through to implementation and ongoing operation. Let's connect.



**Metric**



**DIN**



**Corner cable duct**



**Protective tube**



**Halogen-free  
-25 to 105 °C**



**EX-Area  
-25 to 105 °C**



**Halogen-free  
-25 to 120 °C**

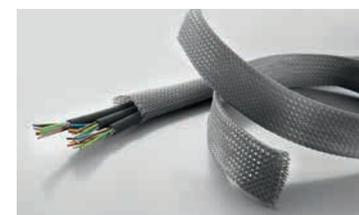

**Equipment**



### Perfectly coordinated complete system

Our product range includes cable ducts in metric versions as well as corner and DIN ducts. There are also variants made of halogen-free material. The range is supplemented by protective tubes, holders, separators, and professional marking solutions.

## Your easy way to flexible and durable cable routing

### The complete range of cable ducts from a single source

Orderly and flexible cable routing in the cabinet not only gives a good impression, but is also essential for functional and safe operation. With our cable ducts, we offer you a complete range from one source. Benefit from our sturdy, torsion-free cable ducts with clever details for quick and efficient installation.

## G

Our wide range of cable routing systems include metric cable ducts, DIN cable ducts and corner cable ducts.



#### Cable ducts

Our cable ducts are available in two basic versions: Metric and DIN. They differ in the slit width and the distance of slots. Ducts with finer slit width are advantageous for applications with small cable cross-sections in conjunction with terminal blocks. The variants designed as corner channels are particularly suitable for control cabinets with limited space and a high line density.

Halogen-free cable ducts offer you more operational safety in areas of increased fire protection

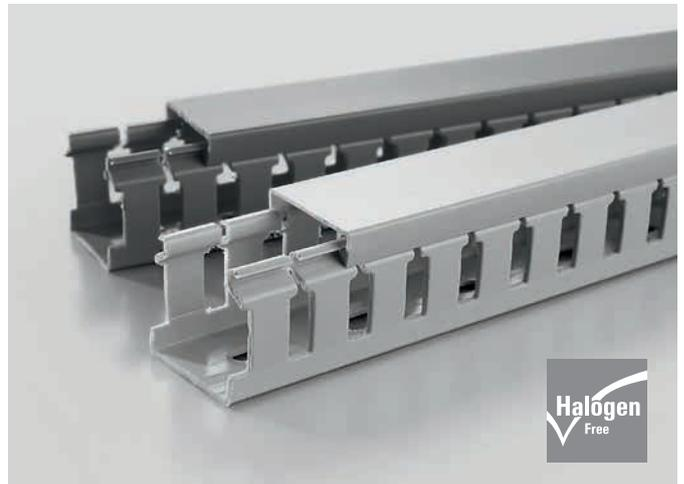

#### Halogen-free cable ducts

In applications where increased fire protection is required, our halogen-free cable ducts offer a higher level of operational safety. They are mainly used in traffic engineering, but also in tunnel systems or for building infrastructure. Our halogen-free materials are characterised by low smoke development and non-toxic waste gases.

### Your advantages with Weidmüller wiring conduits

- Sturdy cable ducts without torsion
- Wire holding lugs as a fixation aid
- Precisely punched bottom holes according to DIN EN 50085-2-3
- Secure fitting lid thanks to an optimum locking mechanism

Spiral and webbing hoses bundle and protect your cables.



### Cable protection conduits

Spiral and webbing hoses are particularly suitable for the construction of space-saving cable routing systems in switch gears and control cabinets. They are used for guiding, protecting and bundling cables and wires - for example, in the transition between the enclosure interior and the door.

More flexibility and efficiency with holders and separators for simple assembly.



### Accessories

With our practical accessories, you can prevent already installed cables and wires from falling out of the cabinet. This simplifies assembly and saves time. Data and power cables can be separated from each other with dividers in the same channel. The covers are also available as accessories and can be ordered individually if required.

Cable ducts

Metric cable duct; slit width 4 / slit clearance 6

Technical data

Material	Colour	Length	Operating temperature	Fire class acc. to UL 94
PVC / lead-free	grey	2000 mm	-5...60 °C	V-0

Ordering data

Order No.	Type	Height	Width	Slit width	Slit gap	Floor rails	Qty [m]
2589060000	CD 17X15 4/6 GY	17 mm	15 mm	4.00 mm	6.00 mm		120
2589080000	CD 30X15 4/6 GY	30 mm	15 mm	4.00 mm	6.00 mm		96
2589110000	CD 30X25 4/6 GY	30 mm	25 mm	4.00 mm	6.00 mm		80
2589100000	CD 40X15 4/6 GY	40 mm	15 mm	4.00 mm	6.00 mm		72
2589130000	CD 40X25 4/6 GY	40 mm	25 mm	4.00 mm	6.00 mm		60
2589210000	CD 40X40 4/6 GY	40 mm	40 mm	4.00 mm	6.00 mm		40
2589280000	CD 40X60 4/6 GY	40 mm	60 mm	4.00 mm	6.00 mm		24
2589350000	CD 40X80 4/6 GY	40 mm	80 mm	4.00 mm	6.00 mm		24
2589150000	CD 60X25 4/6 GY	60 mm	25 mm	4.00 mm	6.00 mm		40
2589230000	CD 60X40 4/6 GY	60 mm	40 mm	4.00 mm	6.00 mm		36
2589300000	CD 60X60 4/6 GY	60 mm	60 mm	4.00 mm	6.00 mm		24
2589370000	CD 60X80 4/6 GY	60 mm	80 mm	4.00 mm	6.00 mm		24
2589420000	CD 60X100 4/6 GY	60 mm	100 mm	4.00 mm	6.00 mm		20
2589180000	CD 80X25 4/6 GY	80 mm	25 mm	4.00 mm	6.00 mm		32
2589240000	CD 80X40 4/6 GY	80 mm	40 mm	4.00 mm	6.00 mm		24
2589310000	CD 80X60 4/6 GY	80 mm	60 mm	4.00 mm	6.00 mm		24
2589380000	CD 80X80 4/6 GY	80 mm	80 mm	4.00 mm	6.00 mm		24
2589440000	CD 80X100 4/6 GY	80 mm	100 mm	4.00 mm	6.00 mm		16
2589190000	CD 100X25 4/6 GY	100 mm	25 mm	4.00 mm	6.00 mm		24
2589260000	CD 100X40 4/6 GY	100 mm	40 mm	4.00 mm	6.00 mm		16
2589330000	CD 100X60 4/6 GY	100 mm	60 mm	4.00 mm	6.00 mm		16
2589670000	CD-BO 40X60 4/6 GY	40 mm	60 mm	4.00 mm	6.00 mm	1	24
2589600000	CD-BO 40X80 4/6 GY	40 mm	80 mm	4.00 mm	6.00 mm	1	24
2589710000	CD-BO 60X40 4/6 GY	60 mm	40 mm	4.00 mm	6.00 mm	1	36
2589640000	CD-BO 60X60 4/6 GY	60 mm	60 mm	4.00 mm	6.00 mm	1	24
2589570000	CD-BO 60X80 4/6 GY	60 mm	80 mm	4.00 mm	6.00 mm	1	24
2589530000	CD-BO 60X100 4/6 GY	60 mm	100 mm	4.00 mm	6.00 mm	1	20
2589470000	CD-BO 60X120 4/6 GY	60 mm	120 mm	4.00 mm	6.00 mm	1	16
2589690000	CD-BO 80X40 4/6 GY	80 mm	40 mm	4.00 mm	6.00 mm	1	24
2589620000	CD-BO 80X60 4/6 GY	80 mm	60 mm	4.00 mm	6.00 mm	1	24
2589550000	CD-BO 80X80 4/6 GY	80 mm	80 mm	4.00 mm	6.00 mm	1	24
2589510000	CD-BO 80X100 4/6 GY	80 mm	100 mm	4.00 mm	6.00 mm	1	16
2589490000	CD-BO 80X120 4/6 GY	80 mm	120 mm	4.00 mm	6.00 mm	1	16
2589400000	CD-BO 100X80 4/6 GY	100 mm	80 mm	4.00 mm	6.00 mm	1	16
2589450000	CD-BO 100X100 4/6 GY	100 mm	100 mm	4.00 mm	6.00 mm	1	16
2589500000	CD-BO 100X120 4/6 GY	100 mm	120 mm	4.00 mm	6.00 mm	2	8

For accessory assignment see product overview



Bottom rail

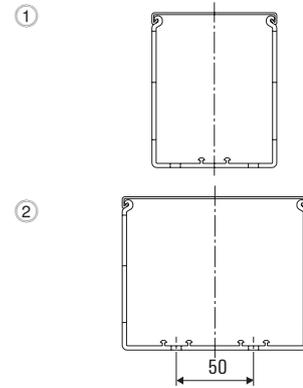

Retainer

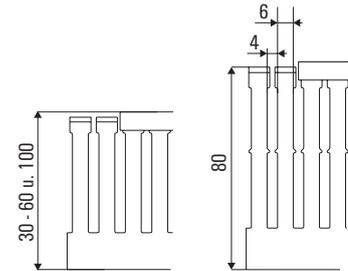

Metric cable duct; blue, slit width 4 / slit clearance 6

Technical data

Material	Colour	Length	Operating temperature	Fire class acc. to UL 94
PVC / lead-free	blue	2000 mm	-5...60 °C	V-0

Ordering data

Order No.	Type	Height	Width	Slit width	Slit gap	Floor rails	Qty [m]
2662660000	CD 40X25 4/6 BL	40 mm	25 mm	4.00 mm	6.00 mm		60
2662650000	CD 40X40 4/6 BL	40 mm	40 mm	4.00 mm	6.00 mm		40
2662460000	CD 40X60 4/6 BL	40 mm	60 mm	4.00 mm	6.00 mm		24
2662470000	CD 40X80 4/6 BL	40 mm	80 mm	4.00 mm	6.00 mm		24
2662600000	CD 60X25 4/6 BL	60 mm	25 mm	4.00 mm	6.00 mm		40
2662480000	CD 60X40 4/6 BL	60 mm	40 mm	4.00 mm	6.00 mm		36
2662490000	CD 60X60 4/6 BL	60 mm	60 mm	4.00 mm	6.00 mm		24
2662520000	CD 60X80 4/6 BL	60 mm	80 mm	4.00 mm	6.00 mm		24
2662530000	CD 60X100 4/6 BL	60 mm	100 mm	4.00 mm	6.00 mm		20
2662610000	CD 80X25 4/6 BL	80 mm	25 mm	4.00 mm	6.00 mm		32
2662540000	CD 80X40 4/6 BL	80 mm	40 mm	4.00 mm	6.00 mm		24
2662550000	CD 80X60 4/6 BL	80 mm	60 mm	4.00 mm	6.00 mm		24
2662560000	CD 80X80 4/6 BL	80 mm	80 mm	4.00 mm	6.00 mm		24
2662570000	CD 80X100 4/6 BL	80 mm	100 mm	4.00 mm	6.00 mm		16
2662620000	CD 100X25 4/6 BL	100 mm	25 mm	4.00 mm	6.00 mm		24
2662630000	CD 100X40 4/6 BL	100 mm	40 mm	4.00 mm	6.00 mm		16
2662640000	CD 100X60 4/6 BL	100 mm	60 mm	4.00 mm	6.00 mm		16
2662580000	CD-BO 100X80 4/6 BL	100 mm	80 mm	4.00 mm	6.00 mm	1	16
2662590000	CD-BO 100X100 4/6 BL	100 mm	100 mm	4.00 mm	6.00 mm	1	16



Retainer

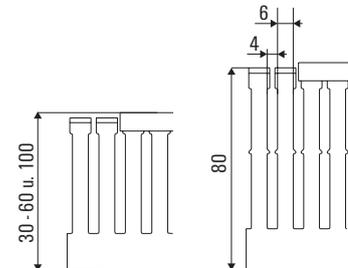

Metric cable duct; slit width 8 / slit clearance 12

Technical data

Material	Colour	Length	Operating temperature	Fire class acc. to UL 94
PVC / lead-free	grey	2000 mm	-5...60 °C	V-0

Ordering data

Order No.	Type	Height	Width	Slit width	Slit gap	Floor rails	Qty [m]
2588450000	CD 30X25 8/12 GY	30 mm	25 mm	8.00 mm	12.00 mm		80
2588560000	CD 30X40 8/12 GY	30 mm	40 mm	8.00 mm	12.00 mm		48
2588650000	CD 30X60 8/12 GY	30 mm	60 mm	8.00 mm	12.00 mm		32
2588460000	CD 40X25 8/12 GY	40 mm	25 mm	8.00 mm	12.00 mm		60
2588580000	CD 40X40 8/12 GY	40 mm	40 mm	8.00 mm	12.00 mm		40
2588660000	CD 40X60 8/12 GY	40 mm	60 mm	8.00 mm	12.00 mm		24
2588730000	CD 40X80 8/12 GY	40 mm	80 mm	8.00 mm	12.00 mm		24
2588510000	CD 60X25 8/12 GY	60 mm	25 mm	8.00 mm	12.00 mm		40
2588600000	CD 60X40 8/12 GY	60 mm	40 mm	8.00 mm	12.00 mm		36
2588680000	CD 60X60 8/12 GY	60 mm	60 mm	8.00 mm	12.00 mm		24
2588750000	CD 60X80 8/12 GY	60 mm	80 mm	8.00 mm	12.00 mm		24
2588820000	CD 60X100 8/12 GY	60 mm	100 mm	8.00 mm	12.00 mm		20
2588530000	CD 80X25 8/12 GY	80 mm	25 mm	8.00 mm	12.00 mm		32
2588610000	CD 80X40 8/12 GY	80 mm	40 mm	8.00 mm	12.00 mm		24
2588700000	CD 80X60 8/12 GY	80 mm	60 mm	8.00 mm	12.00 mm		24
2588770000	CD 80X80 8/12 GY	80 mm	80 mm	8.00 mm	12.00 mm		24
2588840000	CD 80X100 8/12 GY	80 mm	100 mm	8.00 mm	12.00 mm		16
2588540000	CD 100X25 8/12 GY	100 mm	25 mm	8.00 mm	12.00 mm		24
2588630000	CD 100X40 8/12 GY	100 mm	40 mm	8.00 mm	12.00 mm		16
2588720000	CD 100X60 8/12 GY	100 mm	60 mm	8.00 mm	12.00 mm		16
2588870000	CD 150X100 8/12 GY	150 mm	100 mm	8.00 mm	12.00 mm		8
2589890000	CD-BO 40X60 8/12 GY	40 mm	60 mm	8.00 mm	12.00 mm	1	24
2589820000	CD-BO 40X80 8/12 GY	40 mm	80 mm	8.00 mm	12.00 mm	1	24
2588800000	CD-BO 40X100 8/12 GY	40 mm	100 mm	8.00 mm	12.00 mm	1	16
2588890000	CD-BO 40X120 8/12 GY	40 mm	120 mm	8.00 mm	12.00 mm	2	20
2589920000	CD-BO 60X40 8/12 GY	60 mm	40 mm	8.00 mm	12.00 mm	1	36
2589850000	CD-BO 60X60 8/12 GY	60 mm	60 mm	8.00 mm	12.00 mm	1	24
2589800000	CD-BO 60X80 8/12 GY	60 mm	80 mm	8.00 mm	12.00 mm	1	24
2589760000	CD-BO 60X100 8/12 GY	60 mm	100 mm	8.00 mm	12.00 mm	1	20
2588910000	CD-BO 60X120 8/12 GY	60 mm	120 mm	8.00 mm	12.00 mm	2	16
2588960000	CD-BO 60X150 8/12 GY	60 mm	150 mm	8.00 mm	12.00 mm	2	12
2589010000	CD-BO 60X200 8/12 GY	60 mm	200 mm	8.00 mm	12.00 mm	3	8
2589910000	CD-BO 80X40 8/12 GY	80 mm	40 mm	8.00 mm	12.00 mm	1	24
2589840000	CD-BO 80X60 8/12 GY	80 mm	60 mm	8.00 mm	12.00 mm	1	24
2589790000	CD-BO 80X80 8/12 GY	80 mm	80 mm	8.00 mm	12.00 mm	1	24
2589740000	CD-BO 80X100 8/12 GY	80 mm	100 mm	8.00 mm	12.00 mm	1	16
2588920000	CD-BO 80X120 8/12 GY	80 mm	120 mm	8.00 mm	12.00 mm	2	16
2588970000	CD-BO 80X150 8/12 GY	80 mm	150 mm	8.00 mm	12.00 mm	2	12
2589030000	CD-BO 80X200 8/12 GY	80 mm	200 mm	8.00 mm	12.00 mm	3	8
2588790000	CD-BO 100X80 8/12 GY	100 mm	80 mm	8.00 mm	12.00 mm	1	16
2588850000	CD-BO 100X100 8/12 GY	100 mm	100 mm	8.00 mm	12.00 mm	1	16
2588940000	CD-BO 100X120 8/12 GY	100 mm	120 mm	8.00 mm	12.00 mm	2	8
2588990000	CD-BO 100X150 8/12 GY	100 mm	150 mm	8.00 mm	12.00 mm	2	8
2589040000	CD-BO 100X200 8/12 GY	100 mm	200 mm	8.00 mm	12.00 mm	3	8



Bottom rail

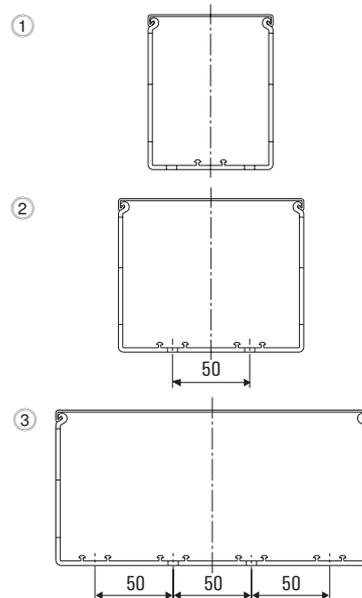

Retainer

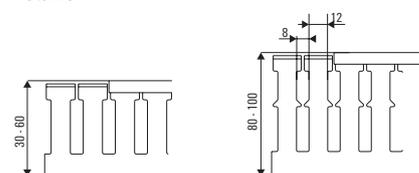

Metric cable duct corner duct, slit width 4 / slit clearance 6

Technical data

Material	Colour	Length	Operating temperature	Fire class acc. to UL 94
PVC / lead-free	grey	2000 mm	-5...60 °C	V-0

Ordering data

Order No.	Type	Height	Width	Slit width	Slit gap	Qty [m]
2589480000	CD-COD 90X90 4/6 GY	90 mm	90 mm	4.00 mm	6.00 mm	8
2589460000	CD-COD 110X110 4/6 GY	110 mm	110 mm	4.00 mm	6.00 mm	8



## Cable ducts

## DIN cable duct; slit width 5 / slit clearance 7.5

## Technical data

Material	Colour	Length	Operating temperature	Fire class acc. to UL 94
PVC / lead-free	grey	2000 mm	-5...60 °C	V-0

## Ordering data

Order No.	Type	Height	Width	Slit width	Slit gap	Qty [m]
2589520000	CD 25X25 5/7.5 GY	25 mm	25 mm	5.00 mm	7.50 mm	84
2589540000	CD 37.5X25 5/7.5 GY	37.5 mm	25 mm	5.00 mm	7.50 mm	64
2589590000	CD 37.5X37.5 5/7.5 GY	37.5 mm	37.5 mm	5.00 mm	7.50 mm	48
2589560000	CD 50X25 5/7.5 GY	50 mm	25 mm	5.00 mm	7.50 mm	52
2589610000	CD 50X37.5 5/7.5 GY	50 mm	37.5 mm	5.00 mm	7.50 mm	32
2590120000	CD 50X50 5/7.5 GY	50 mm	50 mm	5.00 mm	7.50 mm	24
2590170000	CD 50X75 5/7.5 GY	50 mm	75 mm	5.00 mm	7.50 mm	24
2590140000	CD 50X100 5/7.5 GY	50 mm	100 mm	5.00 mm	7.50 mm	16
2589580000	CD 75X25 5/7.5 GY	75 mm	25 mm	5.00 mm	7.50 mm	32
2589630000	CD 75X37.5 5/7.5 GY	75 mm	37.5 mm	5.00 mm	7.50 mm	32
2590150000	CD 75X50 5/7.5 GY	75 mm	50 mm	5.00 mm	7.50 mm	24
2590180000	CD 75X75 5/7.5 GY	75 mm	75 mm	5.00 mm	7.50 mm	16
2590190000	CD 75X100 5/7.5 GY	75 mm	100 mm	5.00 mm	7.50 mm	16
2590160000	CD 75X125 5/7.5 GY	75 mm	125 mm	5.00 mm	7.50 mm	12

## Accessories cable duct cover

## Technical data

Material	Colour	Length	Operating temperature	Fire class acc. to UL 94
PVC / lead-free	grey	2000 mm	-5...60 °C	V-0

## Ordering data

Order No.	Type	Width	Qty [m]
2590130000	CD-LID 15 GY	15 mm	2
2590110000	CD-LID 25 GY	25 mm	2
2590100000	CD-LID 37.5 GY	37.5 mm	2
2590080000	CD-LID 40 GY	40 mm	2
2590070000	CD-LID 50 GY	50 mm	2
2590050000	CD-LID 60 GY	60 mm	2
2590030000	CD-LID 75 GY	75 mm	2
2590020000	CD-LID 80 GY	80 mm	2
2590000000	CD-LID 100 GY	100 mm	2
2589990000	CD-LID 120 GY	120 mm	2
2589970000	CD-LID 125 GY	125 mm	2
2589950000	CD-LID 150 GY	150 mm	2
2589940000	CD-LID 200 GY	200 mm	2

## Halogen-free cable duct, light grey, slit width 5 / slit clearance 7.5

## Technical data

Material	Colour	Length	Operating temperature	Fire class acc. to UL 94
PC-ABS	Light Grey	2000 mm	-25...105 °C	V-0

## Ordering data

Order No.	Type	Height	Width	Slit width	Slit gap	Qty [m]
2589650000	CD-HF 25X25 5/7.5 LTGY	25 mm	25 mm	5.00 mm	7.50 mm	84
2589660000	CD-HF 37.5X25 5/7.5 LTGY	37.5 mm	25 mm	5.00 mm	7.50 mm	64
2589720000	CD-HF 37.5X37.5 5/7.5 LTGY	37.5 mm	37.5 mm	5.00 mm	7.50 mm	48
2589680000	CD-HF 50X25 5/7.5 LTGY	50 mm	25 mm	5.00 mm	7.50 mm	52
2589730000	CD-HF 50X37.5 5/7.5 LTGY	50 mm	37.5 mm	5.00 mm	7.50 mm	32
2589770000	CD-HF 50X50 5/7.5 LTGY	50 mm	50 mm	5.00 mm	7.50 mm	24
2589810000	CD-HF 50X75 5/7.5 LTGY	50 mm	75 mm	5.00 mm	7.50 mm	24
2589860000	CD-HF 50X100 5/7.5 LTGY	50 mm	100 mm	5.00 mm	7.50 mm	16
2589730000	CD-HF 75X25 5/7.5 LTGY	75 mm	25 mm	5.00 mm	7.50 mm	32
2589750000	CD-HF 75X37.5 5/7.5 LTGY	75 mm	37.5 mm	5.00 mm	7.50 mm	32
2589780000	CD-HF 75X50 5/7.5 LTGY	75 mm	50 mm	5.00 mm	7.50 mm	24
2589830000	CD-HF 75X75 5/7.5 LTGY	75 mm	75 mm	5.00 mm	7.50 mm	16
2589880000	CD-HF 75X100 5/7.5 LTGY	75 mm	100 mm	5.00 mm	7.50 mm	16
2589900000	CD-HF 75X125 5/7.5 LTGY	75 mm	125 mm	5.00 mm	7.50 mm	12



Retainer

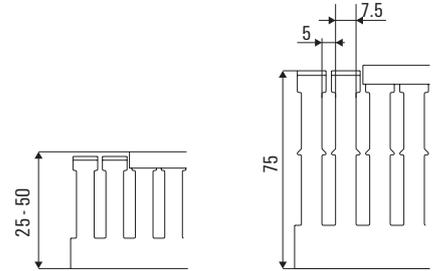



Halogen-free cable duct, blue, slit width 5 / slit clearance 7.5

Technical data

Material	Colour	Length	Operating temperature	Fire class acc. to UL 94
PC-ABS	blue	2000 mm	-25...105 °C	V-0

Ordering data

Order No.	Type	Height	Width	Slit width	Slit gap	Qty [m]
2704800000	CD-HF 37.5X25 5/7.5 BL	37.5 mm	25 mm	5.00 mm	7.50 mm	64
2704810000	CD-HF 37.5X37.5 5/7.5 BL	37.5 mm	37.5 mm	5.00 mm	7.50 mm	48
2704820000	CD-HF 50X25 5/7.5 BL	50 mm	25 mm	5.00 mm	7.50 mm	52
2704830000	CD-HF 50X37.5 5/7.5 BL	50 mm	37.5 mm	5.00 mm	7.50 mm	32
2704840000	CD-HF 50X50 5/7.5 BL	50 mm	50 mm	5.00 mm	7.50 mm	24
2704850000	CD-HF 50X75 5/7.5 BL	50 mm	75 mm	5.00 mm	7.50 mm	24
2704860000	CD-HF 50X100 5/7.5 BL	50 mm	100 mm	5.00 mm	7.50 mm	16
2704870000	CD-HF 75X25 5/7.5 BL	75 mm	25 mm	5.00 mm	7.50 mm	32
2704880000	CD-HF 75X37.5 5/7.5 BL	75 mm	37.5 mm	5.00 mm	7.50 mm	32
2704890000	CD-HF 75X50 5/7.5 BL	75 mm	50 mm	5.00 mm	7.50 mm	24
2704900000	CD-HF 75X75 5/7.5 BL	75 mm	75 mm	5.00 mm	7.50 mm	16
2704910000	CD-HF 75X100 5/7.5 BL	75 mm	100 mm	5.00 mm	7.50 mm	16
2704920000	CD-HF 75X125 5/7.5 BL	75 mm	125 mm	5.00 mm	7.50 mm	12

Accessories halogen-free cable duct cover

Technical data

Material	Colour	Length	Operating temperature	Fire class acc. to UL 94
PC-ABS	Light Grey	2000 mm	-25...105 °C	V-0

Ordering data

Order No.	Type	Width	Qty [m]
2589250000	CD-LID 25 LTGY	25 mm	2
2589220000	CD-LID 37.5 LTGY	37.5 mm	2
2589200000	CD-LID 50 LTGY	50 mm	2
2589170000	CD-LID 75 LTGY	75 mm	2
2589140000	CD-LID 100 LTGY	100 mm	2
2589120000	CD-LID 125 LTGY	125 mm	2

Halogen-free cable duct, dark grey, slit width 5 / slit clearance 7.5

Technical data

Material	Colour	Length	Operating temperature	Fire class acc. to UL 94
PPE	dark grey	2000 mm	-25...120 °C	V-0

Ordering data

Order No.	Type	Height	Width	Slit width	Slit gap	Qty [m]
2589930000	CD-HF 25X25 5/7.5 DKGY	25 mm	25 mm	5.00 mm	7.50 mm	84
2589960000	CD-HF 37.5X25 5/7.5 DKGY	37.5 mm	25 mm	5.00 mm	7.50 mm	64
2590040000	CD-HF 37.5X37.5 5/7.5 DKGY	37.5 mm	37.5 mm	5.00 mm	7.50 mm	48
2589980000	CD-HF 50X25 5/7.5 DKGY	50 mm	25 mm	5.00 mm	7.50 mm	52
2590060000	CD-HF 50X37.5 5/7.5 DKGY	50 mm	37.5 mm	5.00 mm	7.50 mm	32
2589410000	CD-HF 50X50 5/7.5 DKGY	50 mm	50 mm	5.00 mm	7.50 mm	24
2589360000	CD-HF 50X75 5/7.5 DKGY	50 mm	75 mm	5.00 mm	7.50 mm	24
2589320000	CD-HF 50X100 5/7.5 DKGY	50 mm	100 mm	5.00 mm	7.50 mm	16
2590010000	CD-HF 75X25 5/7.5 DKGY	75 mm	25 mm	5.00 mm	7.50 mm	32
2590090000	CD-HF 75X37.5 5/7.5 DKGY	75 mm	37.5 mm	5.00 mm	7.50 mm	32
2589390000	CD-HF 75X50 5/7.5 DKGY	75 mm	50 mm	5.00 mm	7.50 mm	24
2589340000	CD-HF 75X75 5/7.5 DKGY	75 mm	75 mm	5.00 mm	7.50 mm	16
2589290000	CD-HF 75X100 5/7.5 DKGY	75 mm	100 mm	5.00 mm	7.50 mm	16
2589270000	CD-HF 75X125 5/7.5 DKGY	75 mm	125 mm	5.00 mm	7.50 mm	12

Note: on request



Retainer

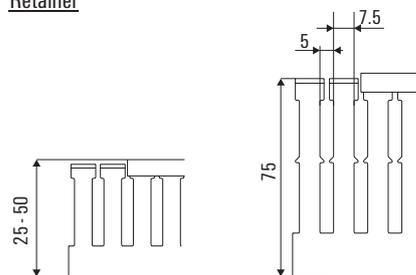

Cabinet Infrastructure

G

## Cable ducts

### Accessories halogen-free cable duct cover

#### Technical data

Material	Colour	Length	Operating temperature	Fire class acc. to UL 94
PPE	dark grey	2000 mm	-25...120 °C	V-0

#### Ordering data

Order No.	Type	Width	Qty [m]
2589090000	CD-LID 25 DKG	25 mm	2
2589070000	CD-LID 37.5 DKG	37.5 mm	2
2589050000	CD-LID 50 DKG	50 mm	2
2589020000	CD-LID 75 DKG	75 mm	2
2589000000	CD-LID 100 DKG	100 mm	2
2588980000	CD-LID 125 DKG	125 mm	2

Note: on request

### Flexible cable duct

#### Technical data

Material	Colour	Length	Operating temperature	Fire class acc. to UL 94
Polypropylene	grey (similar to RAL 7001)	500 mm	-15...80 °C	V-2

#### Ordering data

Order No.	Type	Height	Width	Slit width	Slit gap	Qty.
2562770000	CD-FLEX 12.5X12.5	12.5 mm	12.5 mm	5.00 mm	7.50 mm	50
2562780000	CD-FLEX 20X20	20 mm	20 mm	5.00 mm	7.50 mm	50
2562790000	CD-FLEX 30X30	30 mm	30 mm	5.00 mm	7.50 mm	50
2562800000	CD-FLEX 40X40	40 mm	40 mm	5.00 mm	7.50 mm	50

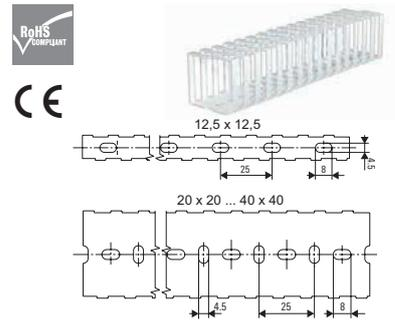

Accessories cable duct holders

Technical data

Material	Colour	Operating temperature	Fire class acc. to UL 94
Polyamide 6 (PA 6)	yellow	-40...100 °C	HB

Ordering data

Order No.	Type	Product type	Channel width	Qty.
2554080000	CD-RETA	Cable duct binder arm	40-120	100
2554020000	CD-RET 40	Cable duct binder	40	500
2554030000	CD-RET 60	Cable duct binder	37.5/50/60	500
2554050000	CD-RET 80	Cable duct binder	80	400
2554060000	CD-RET 100/120	Cable duct binder	75/100/120	250
2554070000	CD-RET 125	Cable duct binder	125	200



Horizontal wiring duct separator

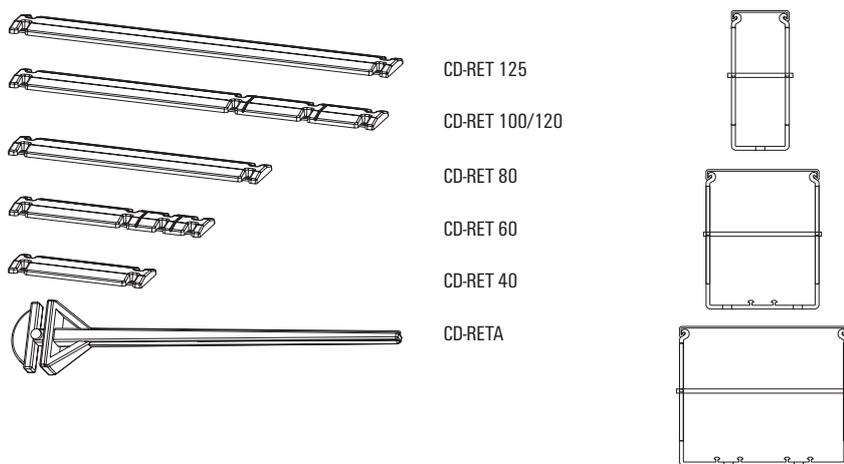

Accessories cable duct holders

Technical data

Material	Colour	Operating temperature	Fire class acc. to UL 94
Polyamide 6 (PA 6)	yellow	-40...100 °C	HB

Ordering data

Order No.	Type	Product type	Channel width	Qty.
2554100000	CD-RETT 60	Cable duct T-form binder	40/60/80/100/120	25
2554090000	CD-RETT 40	Cable duct T-form binder	40/60/80/100/120	40



Horizontal wiring duct separator

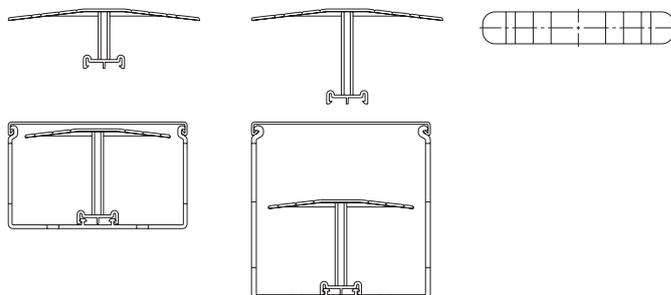

Accessories cable ducts

Cable duct accessories separators

Technical data

Material	Colour	Operating temperature	Fire class acc. to UL 94
PVC	grey	-5...60 °C	V-0

Ordering data

Order No.	Type	Product type	Length	Height	Qty.
2554000000	CD-SCCV	Cable duct screw cover			1000
2553980000	CD-SE 80	Cable duct separator	1000 mm	80 mm	32
2553960000	CD-SE 60	Cable duct separator	1000 mm	60 mm	50
2553950000	CD-SE 40/2	Cable duct separator	1000 mm	40 mm	30
2553970000	CD-SE 40	Cable duct separator	1000 mm	40 mm	60
2553990000	CD-SE 100	Cable duct separator	1000 mm	100 mm	32



Vertical wiring duct separator

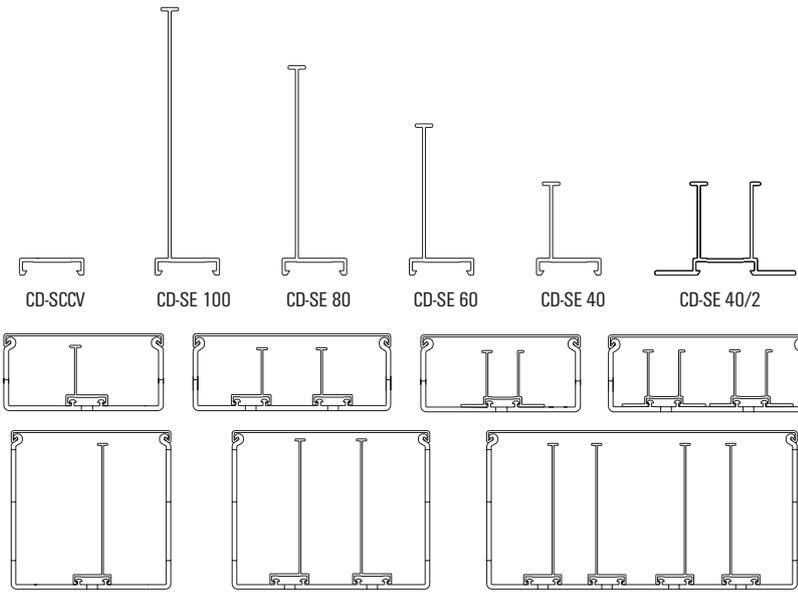

Cable duct accessories cable tie holder

Technical data

Material	Colour	Operating temperature	Fire class acc. to UL 94
PA	black, RAL 7021	-40...1000 °C	HB

Ordering data

Order No.	Type	Product type	Length	Height	Qty.
2554010000	CD-CTH	Cable duct cable tie holder	26 mm	19.6 mm	100

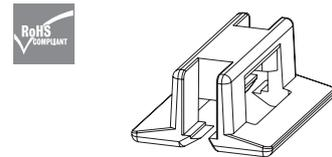

G

Accessories rivets and Expanding-rivet tool

Technical data

Material	Height	Diameter	Weight
Aluminium	224 mm	34 mm	142 g

Ordering data

Order No.	Type	Product type	Drill-hole diameter	Colour	Qty.
2562710000	EXRV-T 6.5	Expanding-rivet tool	6.5 mm	silver, black	4
2562720000	EXRV-T 4.5	Expanding-rivet tool	4.5 mm	silver, green	4

Accessories

Order No.	Type	Product type	Drill-hole diameter	Colour	Qty.
2562690000	EXRV 6.5	Expanding rivet	6.5 mm	black	1000
2562700000	EXRV 4.5	Expanding rivet	4.5 mm	green	1000



Protective cable hose coil

Technical data

Material	Colour	Operating temperature
Polyethylene	black, RAL 7021	-15...60 °C

Ordering data

Order No.	Type	Nominal diameter	Bundle diameter	Length	Fire class acc. to UL 94	Qty [m]
2588590000	CBC-SP 2-12/50 BK	1.5 mm	2...12 mm	400000 mm		50
2588830000	CBC-SP 2-12/50 TP	1.5 mm	2...12 mm	400000 mm		50
2588690000	CBC-SP 2-12/50 V2 WT	1.5 mm	2...12 mm	400000 mm V-2		50
2588570000	CBC-SP 5-50/25 BK	4.2 mm	5...50 mm	200000 mm		25
2588810000	CBC-SP 5-50/25 TP	4.2 mm	5...50 mm	200000 mm		25
2588670000	CBC-SP 5-50/25 V2 WT	4.2 mm	5...50 mm	200000 mm V-2		25
2588550000	CBC-SP 8-70/25 BK	6 mm	8...70 mm	100000 mm		25
2588780000	CBC-SP 8-70/25 TP	6 mm	8...70 mm	100000 mm		25
2588520000	CBC-SP 12-100/25 BK	7.6 mm	12...100 mm	100000 mm		25
2588760000	CBC-SP 12-100/25 TP	7.6 mm	12...100 mm	100000 mm		25
2588640000	CBC-SP 12-100/25 V2 WT	7.6 mm	12...100 mm	100000 mm V-2		25
2588500000	CBC-SP 14-120/25 BK	9.6 mm	14...120 mm	100000 mm		25
2588740000	CBC-SP 14-120/25 TP	9.6 mm	14...120 mm	100000 mm		25
2588620000	CBC-SP 14-120/25 V2 WT	9.6 mm	14...120 mm	100000 mm V-2		25
2588710000	CBC-SP 18-140/20 TP	11.6 mm	18...140 mm	60000 mm		20



Protective cable hose and tools

Technical data

Material	Colour	Operating temperature	Fire class acc. to UL 94
Polypropylene	black, RAL 7021	-20...90 °C	HB

Ordering data

Order No.	Type	Nominal diameter	Bundle diameter	Length	Qty [m]
2588490000	CBC 8/100 BK	8 mm	8 mm	100000 mm	100
2588480000	CBC 15/50 BK	15 mm	15 mm	50000 mm	50
2588470000	CBC 20/30 BK	20 mm	20 mm	30000 mm	30
2589430000	CBC 25/20 BK	25 mm	25 mm	20000 mm	20

Accessories

Order No.	Type	Product type	Diameter	Colour	Qty.
2553910000	CBC-T 8	Protective cable hose tool	8	green	10
2553920000	CBC-T 15	Protective cable hose tool	15	green	10
2553930000	CBC-T 20	Protective cable hose tool	20	green	10
2553940000	CBC-T 25	Protective cable hose tool	25	green	5

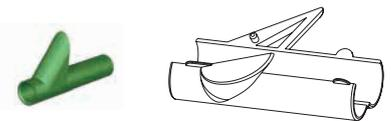

Accessories cable ducts

Protective fabric-reinforced cable hose

Technical data

Material	Colour	Operating temperature	Fire class acc. to UL 94
Polyethylene terephthalate PET	Silver grey	-50...150 °C	HB

Ordering data

Order No.	Type	Nominal diameter	Bundle diameter	Length	Qty [m]
2588950000	CBC-FB 5-10/200	5 mm	5...10 mm	100000 mm	200
2588930000	CBC-FB 10-18/200	10 mm	10...18 mm	200000 mm	200
2588900000	CBC-FB 20-30/100	20 mm	20...30 mm	100000 mm	100
2588880000	CBC-FB 30-45/100	30 mm	30...45 mm	100000 mm	100
2588860000	CBC-FB 50-75/50	50 mm	50...75 mm	50000 mm	50



Accessories cable duct marker

Technical data

Operating temperature
-5...60 °C

Ordering data

Order No.	Type	Product type	Height	Colour	Length	Material	Qty.
2554120000	CD-LBK	Cable duct tag rail kit	30 mm	yellow, grey	500 mm	PVC	20
2562850000	CD-LBH	Cable duct tag rail holder	30 mm	yellow	25 mm	PA	150
2562680000	CD-LB	Cable duct tag rail	15 mm	grey	1000 mm	PVC	150

G

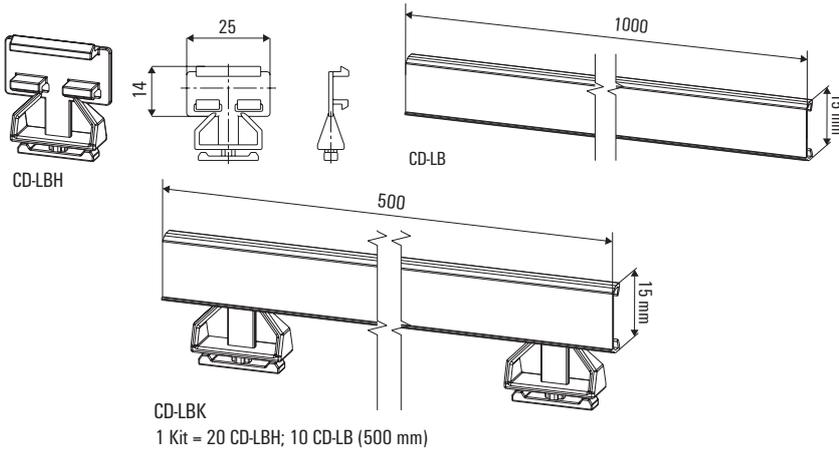

Accessories: cable duct marker

Technical data

Product type	Fire class acc. to UL 94
Device markers	V-0

Ordering data

Order No.	Type	Height	Colour	Length	Operating temperature	Material	Qty.
2006580000	EL 12 MM GE 30M	12 mm	yellow	30000 mm	-40...120 °C	Polyester	1
2006570000	EL 12 MM WS 30M	12 mm	white	30000 mm	-40...120 °C	Polyester	1
2006560000	EL 12 MM SI 30M	12 mm	silver	30000 mm	-40...120 °C	Polyester	1
1876570000	CC 15/17 MC NE WS	15 mm	white		-40...100 °C	Polyamide 66	80
1876770000	CC 15/27 MC NE WS	15 mm	white		-40...100 °C	Polyamide 66	80
1877260000	CC 15/49 MC NE WS	15 mm	white		-40...100 °C	Polyamide 66	40
1877350000	CC 15/60 MC NE WS	15 mm	white		-40...100 °C	Polyamide 66	40



1876770000 - CC 15/27 MC NE WS: Suitable for CD-LBH

**SCHS 3 + SCHS 4**

**Technical data**

Material	Operating temperature	Fire class acc. to UL 94	Version
PVC	-20...80 °C	V-0	Self-adhesive

**Ordering data**

Order No.	Type	Product type	Width	Colour	Height	Qty.
1753480000	SCHS3 K	Accessories	10 mm	black	1000 mm	1
1753460000	SCHS4 K	Accessories	10 mm	grey	1000 mm	1



## Cable ties

## Cable ties

## Technical data

Material	Operating temperature	Fire class acc. to UL 94	Halogen
Polyamide 66	-40...85 °C	V-2	No

## Ordering data

Natural Order No.	black Order No.	Type	Height	Width	Cable diameter, max.	Tensile strength	Qty.
1278600000	1697890000	CB 98/2.5	98 mm	2.5 mm	21 mm	80 N	100
7940006040	7940006047	CB 135/2.5	135 mm	2.5 mm	32 mm	80 N	100
1278700000	1697900000	CB 140/3.5	140 mm	3.6 mm	35 mm	130 N	100
1723540000	1723560000	CB 160/4.5	160 mm	4.5 mm	40 mm	220 N	100
7940006048	7940006049	CB 160/2.6	160 mm	2.6 mm	40 mm	80 N	100
1723550000	1723570000	CB 178/4.8	178 mm	4.8 mm	45 mm	220 N	100
1278800000	1697910000	CB 200/4.5	200 mm	4.5 mm	50 mm	220 N	100
7940006050	7940006051	CB 200/2.6	200 mm	2.6 mm	50 mm	80 N	100
1720630000	1720660000	CB 200/3.5	200 mm	3.6 mm	50 mm	130 N	100
7940006064	7940006065	CB 180/7.8	180 mm	7.8 mm	45 mm	540 N	100
7940006076	7940006077	CB 225/12.5	225 mm	12.5 mm	57 mm	1080 N	50
7940006066	7940006067	CB 240/7.8	240 mm	7.8 mm	63 mm	540 N	100
7940006054	7940006055	CB 250/4.8	250 mm	4.8 mm	68 mm	220 N	100
1720640000	1720650000	CB 290/3.5	290 mm	3.6 mm	80 mm	130 N	100
1278900000	1697920000	CB 290/4.5	290 mm	4.8 mm	80 mm	220 N	100
7940006068	7940006069	CB 300/7.8	300 mm	7.8 mm	80 mm	540 N	100
7940006056	7940006057	CB 370/3.5	370 mm	3.6 mm	103 mm	130 N	100
1279000000	1697930000	CB 360/4.5	360 mm	4.8 mm	103 mm	220 N	100
1279100000	1697940000	CB 365/7.5	365 mm	7.8 mm	100 mm	540 N	100
7940006058	7940006059	CB 390/4.5	390 mm	4.5 mm	106 mm	220 N	100
7940006060	7940006061	CB 430/4.5	430 mm	4.8 mm	115 mm	220 N	100
7940006070	7940006071	CB 450/7.5	450 mm	7.8 mm	130 mm	540 N	100
7940006078	7940006079	CB 500/12.5	500 mm	12.5 mm	143 mm	1080 N	50
7940006072	7940006073	CB 540/7.5	540 mm	7.8 mm	158 mm	540 N	100
1720680000	1720670000	CB 750/7.5	750 mm	7.8 mm	220 mm	540 N	100
7940006074	7940006075	CB 780/9.0	780 mm	9 mm	233 mm	700 N	100
7940006082		CB 850/12.5	850 mm	12.5 mm	255 mm	1080 N	50
	7940006085	CB 1000/12.5	1000 mm	12.5 mm	302 mm	1080 N	50



## Releasable cable ties

## Technical data

Material	Operating temperature	Fire class acc. to UL 94	Halogen
Polyamide 66	-40...85 °C	V-2	No

## Ordering data

Natural Order No.	black Order No.	Type	Height	Width	Cable diameter, max.	Tensile strength	Qty.
1059200000	1059210000	CB-R 200/7.5	200 mm	7.5 mm	40 mm	220 N	100
1059220000	1059230000	CB-R 250/7.5	250 mm	7.5 mm	70 mm	220 N	100
1059240000	1059250000	CB-R 350/7.5	350 mm	7.5 mm	100 mm	220 N	100



## VO cable ties for transportation industry

## Technical data

Material	Operating temperature	Fire class acc. to UL 94	Halogen
Polyamide 66	-40...85 °C	V-0	No

## Ordering data

Order No.	Type	Colour	Height	Width	Cable diameter, max.	Tensile strength	Qty.
2659500000	CB-VT 140/3.6 HF/VO WT	white	140 mm	3.6 mm	35 mm	150 N	100
2659510000	CB-VT 200/3.6 HF/VO WT	white	200 mm	3.6 mm	50 mm	150 N	100
2659520000	CB-VT 200/4.8 HF/VO WT	white	200 mm	4.8 mm	50 mm	220 N	100
2659530000	CB-VT 290/4.8 HF/VO WT	white	290 mm	4.8 mm	79 mm	220 N	100
2659540000	CB-VT 365/7.5 HF/VO WT	white	365 mm	7.5 mm	100 mm	540 N	100
2659490000	CB-VT 98/2.5 HF/VO WT	white	98 mm	2.5 mm	21 mm	80 N	100





## UV stabilised cable ties

## Technical data

Material	Operating temperature	Fire class acc. to UL 94	Halogen
Polyamide 66	-40...85 °C	V-2	No

## Ordering data

Order No.	Type	Colour	Height	Width	Cable diameter, max.	Tensile strength	Qty.
2659320000	CB-UVR 140/3.6 BK	black	140 mm	3.6 mm	35 mm	150 N	100
2659330000	CB-UVR 200/3.6 BK	black	200 mm	3.6 mm	50 mm	150 N	100
2659340000	CB-UVR 200/4.8 BK	black	200 mm	4.8 mm	50 mm	220 N	100
2659350000	CB-UVR 290/4.8 BK	black	290 mm	4.8 mm	79 mm	220 N	100
2659360000	CB-UVR 365/7.5 BK	black	365 mm	7.5 mm	100 mm	540 N	100
2659310000	CB-UVR 98/2.5 BK	black	98 mm	2.5 mm	21 mm	80 N	100



## Heat stabilised cable ties

## Technical data

Material	Operating temperature	Fire class acc. to UL 94	Halogen
Polyamide 66	-40...125 °C	V-2	No

## Ordering data

black Order No.	Natural Order No.	Type	Height	Width	Cable diameter, max.	Tensile strength	Qty.
2659370000	2659430000	CB-HTR 98/2.5	98 mm	2.5 mm	21 mm	80 N	100
2659380000	2659440000	CB-HTR 140/3.6	140 mm	3.6 mm	35 mm	150 N	100
2659390000	2659450000	CB-HTR 200/3.6	200 mm	3.6 mm	50 mm	150 N	100
2659400000	2659460000	CB-HTR 200/4.8	200 mm	4.8 mm	50 mm	220 N	100
2659410000	2659470000	CB-HTR 290/4.8	290 mm	4.8 mm	79 mm	220 N	100
2659420000	2659480000	CB-HTR 365/7.5	365 mm	7.5 mm	100 mm	540 N	100



## Detectable cable ties

## Technical data

Material	Operating temperature	Fire class acc. to UL 94	Halogen
Polyamide 66	-25...85 °C	HB	No

## Ordering data

Order No.	Type	Colour	Height	Width	Cable diameter, max.	Tensile strength	Qty.
2602750000	CB-DT 100/2.5 BL	blue	100 mm	2.5 mm	24 mm	80 N	100
2602760000	CB-DT 140/3.5 BL	blue	140 mm	3.5 mm	36 mm	180 N	100
2602770000	CB-DT 200/4.5 BL	blue	200 mm	4.5 mm	51 mm	220 N	100
2602780000	CB-DT 280/4.5 BL	blue	280 mm	4.5 mm	76 mm	220 N	100
2602790000	CB-DT 380/4.5 BL	blue	380 mm	4.5 mm	110 mm	220 N	100



## Stainless steel cable ties

## Technical data

Material	Operating temperature	Fire class acc. to UL 94	Halogen
Stainless steel 1.4301	-80...538 °C		No

## Ordering data

Order No.	Type	Colour	Height	Width	Cable diameter, max.	Tensile strength	Qty.
1699800000	SCT 4.6/127 C	silver	127 mm	4.6 mm	25 mm	445 N	100
1699900000	SCT 4.6/266 C	silver	266 mm	4.6 mm	69 mm	445 N	100
1699910000	SCT 4.6/360 C	silver	360 mm	4.6 mm	101 mm	445 N	100
1699920000	SCT 4.6/520	silver	520 mm	4.6 mm	152 mm	445 N	100
1699930000	SCT 4.6/679	silver	679 mm	4.6 mm	203 mm	445 N	100
1699940000	SCT 4.6/838	silver	838 mm	4.6 mm	254 mm	445 N	100
1699810000	SCT 4.6/201 C	silver	201 mm	4.6 mm	51 mm	445 N	100



## Cable ties

### Stainless steel cable ties, coated

#### Technical data

Material	Operating temperature	Fire class acc. to UL 94	Halogen
Stainless steel, polyester coated	-80...150 °C		No

#### Ordering data

Order No.	Type	Colour	Height	Width	Cable diameter, max.	Tensile strength	Qty.
1015220000	SCT-C 4.6/100	black	100 mm	4.6 mm	21 mm	445 N	100
1015230000	SCT-C 4.6/125	black	125 mm	4.6 mm	27 mm	445 N	100
1015240000	SCT-C 4.6/150	black	150 mm	4.6 mm	35 mm	445 N	100
1015250000	SCT-C 4.6/200	black	200 mm	4.6 mm	50 mm	445 N	100
1015270000	SCT-C 4.6/360	black	360 mm	4.6 mm	100 mm	445 N	100
1015280000	SCT-C 4.6/520	black	520 mm	4.6 mm	150 mm	445 N	100
1015290000	SCT-C 4.6/680	black	680 mm	4.6 mm	200 mm	445 N	100
1015300000	SCT-C 4.6/840	black	840 mm	4.6 mm	250 mm	445 N	100
1015310000	SCT-C 7.9/200	black	200 mm	7.9 mm	50 mm	1112 N	100
1015320000	SCT-C 7.9/360	black	360 mm	7.9 mm	100 mm	1112 N	100
1015330000	SCT-C 7.9/520	black	520 mm	7.9 mm	150 mm	1112 N	100
1015340000	SCT-C 7.9/680	black	680 mm	7.9 mm	200 mm	1112 N	100
1015350000	SCT-C 7.9/840	black	840 mm	7.9 mm	250 mm	1112 N	100



## Accessories cable ties

## Ordering data

natural Order No.	black Order No.	Type	Dimensions (LxW) mm	Ø-Mounting hole (mm)	Max. (mm) Cable tie width	Fig.	A	B	C	D	H
1279200000		CBH 8.1/6.2	8.1 x 6.2	6.5	7.8	1	10	10.5	8.1	6.2	18.7
1289200000	1697950000	CBH 19/19	19 x 19		3.6	2	19	19	4	4.1	5
1289400000	1697960000	CBH 27/27	27 x 27		4.8	2	27	27	6	4.8	6.5
1279300000		CBDM 200/4.5	200 x 4.5	6.3							
	1859410000	CBFP 43.5/10	43.5 x 10	8	9	3	10	37	6.5	9.7	



CBH 8.1/6.2

CBDM 200/4.5



CBH 19/19

CBH 27/27



CBFP

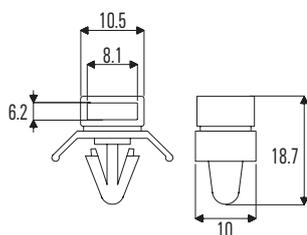

Figure 1

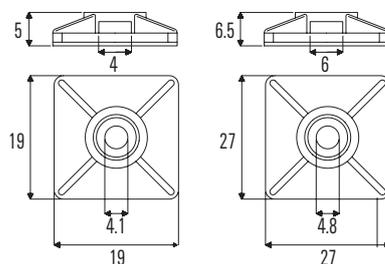

Figure 2

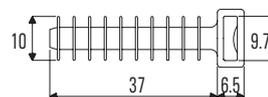

Figure 3

Cable tie tools are compact tools with which the cable tie is tightened and the excess tie cut off in one operation.

## Accessories tool

## Ordering data

Order No.	Type	Colour	Length	Weight	Qty.
1296000000	CABLE TIE TOOL RT-1	rot	160 mm	260	1
1774470000	WSM TOOL AUTOMATIK	silber	275 mm	579	1
1774480000	WSM TOOL MANUELL	silber	220 mm	633	1





# Service and support

---

<b>Service and support</b>	Our expertise for your requirements	V.2
	Engineering support and customised assembly	V.3
	Personal Support	V.4

---

## Our expertise for your requirements

### Service connects – worldwide



Automation technology functions are becoming more complex in a globally-oriented world facing ambitious targets in terms of energy efficiency and smart production. We are your equal partners for the best connections in Industrial Connectivity.

Our personal support can answer any questions reliably and expertly. Our online services are available 365 day a year around the clock to provide answers to your questions on our products - from user documentation through software to planning tools.

In short: Weidmüller's global service combines our expertise with your requirements.



**Your way to our service**  
[www.weidmueller.com/service](http://www.weidmueller.com/service)

## Engineering support and customised assembly

Automation engineering and connectivity consulting belongs to our services as well as assembly of engineered products. We also support the process from the idea to the product with our Weidmüller Configurator and the Configure-to-Order process.



### Consulting and engineering

The challenge for you is reducing costs and increasing efficiency. This requires intelligent, individual solutions. Whether it is modified products, pre-fitted mounting rails or complete small cabinets - our application centres provide a highly qualified custom-made engineering and production service.



### Connectivity Consulting

Alongside our product offering, we support you with our range of services through all the phases of machine construction. The result of this collaboration is a reduction of up to 30% in cycle times, up to 20% more space in the control cabinet and significant fault reduction. Our experienced Connectivity Consulting team delivers a practical impetus rather than just abstract theories.



### Fitted mounting rails

Your processes in panel building have to be fast, flexible and productive. This is the only way you can cut your costs and increase efficiency. Depending on the application in question, you will have different requirements with respect to the engineering service, delivery speed and flexibility to be provided.



### Processed and assembled enclosures

To compete internationally, your plants need to satisfy high standards of safety, quality and performance. The smart combination of consultation, application expertise and industry know-how is our key to finding a custom-fit solution for your application. Reduce costs and increase efficiency

## Personal support

Exactly the right help and information on our solutions and products



If our products are used in your automation technology applications, you need the best possible individual support, from planning through installation to operation. For every stage of your application, we can offer the right tools and information for our products and solutions. Up-to-date, uncomplicated, comprehensive and around the clock via our service portal at [www.weidmueller.com/support](http://www.weidmueller.com/support).

V



**Your way to your local personal support**  
[www.weidmueller.com/support](http://www.weidmueller.com/support)





### Technical downloads

All information, such as technical data, manuals, certificates and much more for the appropriate use of our products and solutions in your application



### Engineering data

For the quick integration of our products into your design, there are a lot of digital product data for engineering systems like EPLAN, Zuken E3.series, WSCAD and many others available for download.



### Product software

Our software makes using and configuration of our products easier for you when it comes to operation, configuration and monitoring



### Approvals, certificates & declaration of conformity

We supply product- or company-related approvals and certificates for your documentation



### Security advisory board

Our Product Security Incident Response Team (PSIRT) continuously informs you about possible security-related vulnerabilities of our products



# Index

---

<b>Index</b>	Index Type	X.2
	Index Order No.	X.13
	Addresses worldwide	X.26

---

Type	Order No.	Page
<b>A</b>		
ADAPTER ALU STI-S	1762440000	C.13
ADAPTER ALU STI-S	1762440000	C.15
<b>B</b>		
BZT 1 WS 10/5	1805490000	F.5
BZT 1 ZA WS 10/5	1805620000	F.5
BZT 2 WS 10/5	1805480000	F.5
<b>C</b>		
CB 1000/12.5 BLACK	7940006085	G.30
CB 135/2.5 BLACK	7940006047	G.30
CB 135/2.5 NATUR	7940006040	G.30
CB 140/3.5 BLACK	1278700000	G.30
CB 140/3.6 NATUR	1697900000	G.30
CB 160/2.6 BLACK	7940006049	G.30
CB 160/2.6 NATUR	7940006048	G.30
CB 160/4.5 BLACK	1723560000	G.30
CB 160/4.5 NATUR	1723540000	G.30
CB 178/4.8 BLACK	1723570000	G.30
CB 178/4.8 NATUR	1723550000	G.30
CB 180/7.8 BLACK	7940006065	G.30
CB 180/7.8 NATUR	7940006064	G.30
CB 200/2.6 BLACK	7940006051	G.30
CB 200/2.6 NATUR	7940006050	G.30
CB 200/3.5 BLACK	1720660000	G.30
CB 200/3.5 NATUR	1720630000	G.30
CB 200/4.5 BLACK	1697910000	G.30
CB 200/4.5 NATUR	1278800000	G.30
CB 225/12.5 BLACK	7940006077	G.30
CB 225/12.5 NATUR	7940006076	G.30
CB 240/7.8 BLACK	7940006067	G.30
CB 240/7.8 NATUR	7940006066	G.30
CB 250/4.8 BLACK	7940006055	G.30
CB 250/4.8 NATUR	7940006054	G.30
CB 290/3.5 BLACK	1720650000	G.30
CB 290/3.5 NATUR	1720640000	G.30
CB 290/4.5 BLACK	1697920000	G.30
CB 290/4.5 NATUR	1278900000	G.30
CB 300/7.8 BLACK	7940006069	G.30
CB 300/7.8 NATUR	7940006068	G.30
CB 360/4.5 BLACK	1697930000	G.30
CB 360/4.5 NATUR	1279000000	G.30
CB 365/7.5 BLACK	1697940000	G.30
CB 365/7.5 NATUR	1279100000	G.30
CB 370/3.5 BLACK	7940006057	G.30
CB 370/3.5 NATUR	7940006056	G.30
CB 390/4.5 BLACK	7940006059	G.30
CB 390/4.5 NATUR	7940006058	G.30
CB 430/4.5 BLACK	7940006061	G.30
CB 430/4.5 NATUR	7940006060	G.30
CB 450/7.5 BLACK	7940006071	G.30
CB 450/7.5 NATUR	7940006070	G.30
CB 500/12.5 BLACK	7940006079	G.30
CB 500/12.5 NATUR	7940006078	G.30
CB 540/7.5 BLACK	7940006073	G.30
CB 540/7.5 NATUR	7940006072	G.30
CB 750/7.5 BLACK	1720670000	G.30
CB 750/7.5 NATUR	1720680000	G.30
CB 780/9.0 BLACK	7940006075	G.30
CB 780/9.0 NATUR	7940006074	G.30
CB 850/12.5 NATUR	7940006082	G.30
CB 98/2.5 BLACK	1697980000	G.30
CB 98/2.5 NATUR	1278600000	G.30
CBC 15/60 BK	2588480000	G.27
CBC 20/30 BK	2588470000	G.27
CBC 25/20 BK	2588430000	G.27
CBC 8/100 BK	2588490000	G.27
CBC-FB 10-18/200	2588930000	G.28
CBC-FB 20-30/100	2588900000	G.28
CBC-FB 30-45/100	2588880000	G.28
CBC-FB 50-75/50	2588860000	G.28
CBC-FB 5-10/200	2588950000	G.28
CBC-SP 12-100/25 BK	2588520000	G.27
CBC-SP 12-100/25 TP	2588760000	G.27
CBC-SP 12-100/25 V2 WT	2588640000	G.27
CBC-SP 14-120/25 BK	2588500000	G.27
CBC-SP 14-120/25 TP	2588740000	G.27
CBC-SP 14-120/25 V2 WT	2588820000	G.27
CBC-SP 18-140/20 TP	2588710000	G.27
CBC-SP 2-12/50 BK	2588950000	G.27
CBC-SP 2-12/50 TP	2588830000	G.27
CBC-SP 2-12/50 V2 WT	2588690000	G.27
CBC-SP 5-50/25 BK	2588570000	G.27
CBC-SP 5-50/25 TP	2588810000	G.27
CBC-SP 5-50/25 V2 WT	2588670000	G.27
CBC-SP 8-70/25 BK	2588950000	G.27
CBC-SP 8-70/25 TP	2588780000	G.27
CBC-T 15	2553920000	G.27
CBC-T 20	2553930000	G.27
CBC-T 25	2553940000	G.27
CBC-T 8	2553910000	G.27
CBDM 200/4.5 NA	1279300000	G.33
CB-DT 100/2.5 BL	2602750000	G.31
CB-DT 140/3.5 BL	2602760000	G.31
CB-DT 200/4.5 BL	2602770000	G.31

Type	Order No.	Page
CB-DT 280/4.5 BL	2602780000	G.31
CB-DT 380/4.5 BL	2602790000	G.31
CBFP 43.5/10 BLACK	1859410000	G.33
CBH 19/19 BLACK	1697950000	G.33
CBH 19/19 NATUR	1289200000	G.33
CBH 27/27 NATUR	1289400000	G.33
CBH 27/27 SW	1697960000	G.33
CBH 8.1/6.2 NATUR	1279200000	G.33
CB-HTR 140/3.6 BK	2659380000	G.31
CB-HTR 140/3.6 NC	2659440000	G.31
CB-HTR 200/3.6 BK	2659430000	G.31
CB-HTR 200/3.6 NC	2659450000	G.31
CB-HTR 200/4.8 BK	2659400000	G.31
CB-HTR 200/4.8 NC	2659460000	G.31
CB-HTR 290/4.8 BK	2659410000	G.31
CB-HTR 290/4.8 NC	2659470000	G.31
CB-HTR 365/7.5 BK	2659420000	G.31
CB-HTR 365/7.5 NC	2659480000	G.31
CB-HTR 98/2.5 BK	2659370000	G.31
CB-HTR 98/2.5 NC	2659430000	G.31
CB-R 200/7.5 BLACK	1059210000	G.30
CB-R 200/7.5 NATUR	1059200000	G.30
CB-R 250/7.5 BLACK	1059230000	G.30
CB-R 250/7.5 NATUR	1059220000	G.30
CB-R 350/7.5 BLACK	1059250000	G.30
CB-R 350/7.5 NATUR	1059240000	G.30
CB-UVR 140/3.6 BK	2659320000	G.31
CB-UVR 200/3.6 BK	2659330000	G.31
CB-UVR 200/4.8 BK	2659340000	G.31
CB-UVR 290/4.8 BK	2659350000	G.31
CB-UVR 365/7.5 BK	2659360000	G.31
CB-UVR 98/2.5 BK	2659310000	G.31
CB-VT 140/3.6 HF/V0 WT	2659500000	G.30
CB-VT 200/3.6 HF/V0 WT	2659510000	G.30
CB-VT 200/4.8 HF/V0 WT	2659520000	G.30
CB-VT 290/4.8 HF/V0 WT	2659530000	G.30
CB-VT 365/7.5 HF/V0 WT	2659540000	G.30
CC 15/17 K MC NE GE	1131920000	C.159
CC 15/17 K MC NE GR	1079540000	C.159
CC 15/17 K MC NE RT	1288320000	C.159
CC 15/17 K MC NE SI	1288580000	C.159
CC 15/17 K MC NE WS	1876590000	C.159
CC 15/17 K MC SDR	1876600000	C.159
CC 15/17 MC NE GE	1131930000	C.159
CC 15/17 MC NE GR	1079530000	C.159
CC 15/17 MC NE SI	1876610000	C.159
CC 15/17 MC NE WS	1876570000	C.159
CC 15/17 MC NE WS	1876570000	G.28
CC 15/17 MC SDR	1876620000	C.159
CC 15/27 K MC NE GE	1131910000	C.159
CC 15/27 K MC NE GR	1079560000	C.159
CC 15/27 K MC NE RT	1288330000	C.159
CC 15/27 K MC NE SI	1876780000	C.159
CC 15/27 K MC NE WS	1876640000	C.159
CC 15/27 K MC SDR	1876750000	C.159
CC 15/27 MC NE GE	1131940000	C.159
CC 15/27 MC NE GR	1079550000	C.159
CC 15/27 MC NE SI	1876760000	C.159
CC 15/27 MC NE WS	1876770000	C.159
CC 15/27 MC NE WS	1876770000	F.21
CC 15/27 MC NE WS	1876770000	G.28
CC 15/27 MC SDR	1876630000	C.159
CC 15/27 MM GE	2005630000	D.38
CC 15/27 MM GR	2005660000	D.38
CC 15/27 MM SW	2005690000	D.38
CC 15/27 MM WS	2005680000	D.38
CC 15/45 K MC NE GE	1111260000	C.160
CC 15/45 K MC NE GR	1111270000	C.160
CC 15/45 K MC NE WS	1111250000	C.160
CC 15/45 K MC SDR	1111200000	C.160
CC 15/45 MC NE GE	1111230000	C.160
CC 15/45 MC NE GR	1111240000	C.160
CC 15/45 MC NE WS	1111210000	C.160
CC 15/45 MC SDR	1111190000	C.160
CC 15/45 MM GE	2005520000	D.38
CC 15/45 MM GR	2005540000	D.38
CC 15/45 MM SW	2005570000	D.38
CC 15/45 MM WS	2005500000	D.38
CC 15/49 K MC NE GE	1131970000	C.160
CC 15/49 K MC NE GR	1079580000	C.160
CC 15/49 K MC NE RT	1288380000	C.160
CC 15/49 K MC NE SI	1877270000	C.160
CC 15/49 K MC NE WS	1877220000	C.160
CC 15/49 K MC SDR	1877230000	C.160
CC 15/49 MC NE GE	1076970000	C.160
CC 15/49 MC NE GR	1079570000	C.160
CC 15/49 MC NE SI	1877240000	C.160
CC 15/49 MC NE WS	1877260000	C.160
CC 15/49 MC NE WS	1877260000	F.21
CC 15/49 MC NE WS	1877260000	G.28
CC 15/49 MC SDR	1877200000	C.160
CC 15/60 K MC NE GE	1131890000	C.161
CC 15/60 K MC NE GR	1072650000	C.161
CC 15/60 K MC NE RT	1288340000	C.161
CC 15/60 K MC NE SI	1877360000	C.161
CC 15/60 K MC NE WS	1877310000	C.161
CC 15/60 K MC SDR	1877320000	C.161

Type	Order No.	Page
CC 15/60 MC NE GE	1131960000	C.161
CC 15/60 MC NE GR	1072640000	C.161
CC 15/60 MC NE SI	1877340000	C.161
CC 15/60 MC NE WS	1877350000	C.161
CC 15/60 MC NE WS	1877350000	F.21
CC 15/60 MC NE WS	1877350000	G.28
CC 15/60 MC SDR	1877300000	C.161
CC 15/60 MM GE	2005430000	D.38
CC 15/60 MM GR	2005460000	D.38
CC 15/60 MM SW	2005480000	D.38
CC 15/60 MM WS	2005410000	D.38
CC 15/60 04MM MC NE GE	1131880000	C.161
CC 15/60 04MM MC NE GR	1304060000	C.161
CC 15/60 04MM MC NE SI	1059990000	C.161
CC 15/60 04MM MC NE WS	1057580000	C.161
CC 15/60 04MM MC SDR	1060010000	C.161
CC 30/60 K MC NE GE	1078320000	C.162
CC 30/60 K MC NE GR	1072680000	C.162
CC 30/60 K MC NE RT	1085430000	C.162
CC 30/60 K MC NE SI	1934330000	C.162
CC 30/60 K MC NE WS	1934390000	C.162
CC 30/60 K MC SDR	1934370000	C.162
CC 30/60 MC NE GE	1009320000	C.162
CC 30/60 MC NE GR	1072670000	C.162
CC 30/60 MC NE SI	1934400000	C.162
CC 30/60 MC NE WS	1934420000	C.162
CC 30/60 MC SDR	1934410000	C.162
CC 30/60 MM GE	2005350000	D.38
CC 30/60 MM GR	2005370000	D.38
CC 30/60 MM SW	2005390000	D.38
CC 30/60 MM WS	2005330000	D.38
CC 30/60 04MM MC NE BL	1158840000	C.163
CC 30/60 04MM MC NE GE	1083160000	C.163
CC 30/60 04MM MC NE GR	1158820000	C.163
CC 30/60 04MM MC NE RT	1083170000	C.163
CC 30/60 04MM MC NE WS	1158830000	C.163
CC 30/60 04MM MC NE WS	1083150000	C.163
CC 30/60 04MM MC SDR	1083190000	C.163
CC 85/27 K MC NE GE	1526120000	C.163
CC 85/27 K MC NE GR	1526130000	C.163
CC 85/27 K MC NE SI	2123070000	C.163
CC 85/27 K MC NE WS	1526100000	C.163
CC 85/27 K MC SDR	1526140000	C.163
CC 85/27 MC NE GE	1520940000	C.163
CC 85/27 MC NE GR	1520970000	C.163
CC 85/27 MC NE WS	1520930000	C.163
CC 85/27 MC SDR	1525850000	C.163
CC 85/54 K MC NE GE	1138440000	C.164
CC 85/54 K MC NE GR	1138450000	C.164
CC 85/54 K MC NE RT	1288390000	C.164
CC 85/54 K MC NE WS	1138430000	C.164
CC 85/54 K MC SDR	1138470000	C.164
CC 85/54 MC NE GE	1138410000	C.164
CC 85/54 MC NE GR	1138420000	C.164
CC 85/54 MC NE WS	1138400000	C.164
CC 85/54 MC SDR	1138460000	C.164
CC 85/54 MM GE	2005280000	D.38



Type	Order No.	Page	Type	Order No.	Page	Type	Order No.	Page	Type	Order No.	Page
CLJ C 1-3 GE/SW 9 MP	0252611529	E.16	CLJ C 1-3 WS/SW 4 CD	1568250004	E.18	CLJ C 1-6 GE/SW 30 MP	0252711551	E.21	CLJ C 1-6 GE/SW 80 CD	1868811601	E.24
CLJ C 1-3 GE/SW A CD	1568251637	E.19	CLJ C 1-3 WS/SW 5 CD	1568250005	E.18	CLJ C 1-6 GE/SW 31 CD	1868811552	E.23	CLJ C 1-6 GE/SW 80 MP	0252711601	E.22
CLJ C 1-3 GE/SW A CD	1568251797	E.20	CLJ C 1-3 WS/SW 6 CD	1568250006	E.18	CLJ C 1-6 GE/SW 31 MP	0252711552	E.21	CLJ C 1-6 GE/SW 81 CD	1868811602	E.24
CLJ C 1-3 GE/SW A CD	1568251799	E.20	CLJ C 1-3 WS/SW 7 CD	1568250007	E.18	CLJ C 1-6 GE/SW 32 CD	1868811553	E.23	CLJ C 1-6 GE/SW 81 MP	0252711602	E.22
CLJ C 1-3 GE/SW A MP	0252611637	E.17	CLJ C 1-3 WS/SW 8 CD	1568250008	E.18	CLJ C 1-6 GE/SW 32 MP	0252711553	E.21	CLJ C 1-6 GE/SW 82 CD	1868811603	E.24
CLJ C 1-3 GE/SW A MP	0252611697	E.17	CLJ C 1-3 WS/SW 9 CD	1568251530	E.18	CLJ C 1-6 GE/SW 33 CD	1868811554	E.23	CLJ C 1-6 GE/SW 82 MP	0252711603	E.22
CLJ C 1-3 GE/SW A MP	0252611699	E.17	CLJ C 1-3 WS/SW 9 MP	0252611530	E.16	CLJ C 1-6 GE/SW 33 MP	0252711554	E.21	CLJ C 1-6 GE/SW 83 CD	1868811604	E.24
CLJ C 1-3 GE/SW AC CD	1568251752	E.20	CLJ C 1-3 WS/SW A CD	1568251021	E.19	CLJ C 1-6 GE/SW 34 CD	1868811555	E.23	CLJ C 1-6 GE/SW 83 MP	0252711604	E.22
CLJ C 1-3 GE/SW AC MP	0252611752	E.17	CLJ C 1-3 WS/SW B CD	1568251022	E.19	CLJ C 1-6 GE/SW 34 MP	0252711555	E.21	CLJ C 1-6 GE/SW 84 CD	1868811605	E.24
CLJ C 1-3 GE/SW A CD	1568251735	E.20	CLJ C 1-3 WS/SW C CD	1568251023	E.19	CLJ C 1-6 GE/SW 35 CD	1868811556	E.23	CLJ C 1-6 GE/SW 84 MP	0252711605	E.22
CLJ C 1-3 GE/SW B CD	1568251639	E.19	CLJ C 1-3 WS/SW D CD	1568251024	E.19	CLJ C 1-6 GE/SW 35 MP	0252711556	E.21	CLJ C 1-6 GE/SW 85 CD	1868811606	E.24
CLJ C 1-3 GE/SW B MP	0252611639	E.17	CLJ C 1-3 WS/SW E CD	1568251025	E.19	CLJ C 1-6 GE/SW 36 CD	1868811557	E.23	CLJ C 1-6 GE/SW 85 MP	0252711606	E.22
CLJ C 1-3 GE/SW C CD	1568251641	E.19	CLJ C 1-3 WS/SW ET CD	1568251053	E.20	CLJ C 1-6 GE/SW 36 MP	0252711557	E.21	CLJ C 1-6 GE/SW 86 CD	1868811607	E.24
CLJ C 1-3 GE/SW C MP	0252611641	E.17	CLJ C 1-3 WS/SW F CD	1568251026	E.19	CLJ C 1-6 GE/SW 37 CD	1868811558	E.23	CLJ C 1-6 GE/SW 86 MP	0252711607	E.22
CLJ C 1-3 GE/SW D CD	1568251643	E.19	CLJ C 1-3 WS/SW G CD	1568251027	E.19	CLJ C 1-6 GE/SW 37 MP	0252711558	E.21	CLJ C 1-6 GE/SW 87 CD	1868811608	E.24
CLJ C 1-3 GE/SW D MP	0252611643	E.17	CLJ C 1-3 WS/SW H CD	1568251028	E.19	CLJ C 1-6 GE/SW 38 CD	1868811559	E.23	CLJ C 1-6 GE/SW 87 MP	0252711608	E.22
CLJ C 1-3 GE/SW E CD	1568251645	E.19	CLJ C 1-3 WS/SW I CD	1568251029	E.19	CLJ C 1-6 GE/SW 38 MP	0252711559	E.21	CLJ C 1-6 GE/SW 88 CD	1868811609	E.24
CLJ C 1-3 GE/SW E MP	0252611645	E.17	CLJ C 1-3 WS/SW J CD	1568251030	E.19	CLJ C 1-6 GE/SW 39 CD	1868811560	E.23	CLJ C 1-6 GE/SW 88 MP	0252711609	E.22
CLJ C 1-3 GE/SW ET CD	1568251746	E.20	CLJ C 1-3 WS/SW K CD	1568251031	E.19	CLJ C 1-6 GE/SW 39 MP	0252711560	E.21	CLJ C 1-6 GE/SW 89 CD	1868811610	E.24
CLJ C 1-3 GE/SW ET MP	0252611746	E.17	CLJ C 1-3 WS/SW L CD	1568251032	E.19	CLJ C 1-6 GE/SW 40 CD	1868811561	E.23	CLJ C 1-6 GE/SW 89 MP	0252711610	E.22
CLJ C 1-3 GE/SW F CD	1568251647	E.19	CLJ C 1-3 WS/SW M CD	1568251033	E.19	CLJ C 1-6 GE/SW 40 MP	0252711561	E.21	CLJ C 1-6 GE/SW 90 CD	1868811611	E.24
CLJ C 1-3 GE/SW F MP	0252611647	E.17	CLJ C 1-3 WS/SW N CD	1568251034	E.19	CLJ C 1-6 GE/SW 41 CD	1868811562	E.23	CLJ C 1-6 GE/SW 90 MP	0252711611	E.22
CLJ C 1-3 GE/SW G CD	1568251649	E.19	CLJ C 1-3 WS/SW O CD	1568251035	E.19	CLJ C 1-6 GE/SW 41 MP	0252711562	E.21	CLJ C 1-6 GE/SW 91 CD	1868811612	E.24
CLJ C 1-3 GE/SW G MP	0252611649	E.17	CLJ C 1-3 WS/SW O CD	1568251057	E.20	CLJ C 1-6 GE/SW 42 CD	1868811563	E.23	CLJ C 1-6 GE/SW 91 MP	0252711612	E.22
CLJ C 1-3 GE/SW H CD	1568251651	E.19	CLJ C 1-3 WS/SW P CD	1568251036	E.19	CLJ C 1-6 GE/SW 42 MP	0252711563	E.21	CLJ C 1-6 GE/SW 92 CD	1868811613	E.24
CLJ C 1-3 GE/SW H MP	0252611651	E.17	CLJ C 1-3 WS/SW PET. CD	1568251058	E.20	CLJ C 1-6 GE/SW 43 CD	1868811564	E.23	CLJ C 1-6 GE/SW 92 MP	0252711613	E.22
CLJ C 1-3 GE/SW I CD	1568251653	E.19	CLJ C 1-3 WS/SW Q CD	1568251037	E.19	CLJ C 1-6 GE/SW 43 MP	0252711564	E.21	CLJ C 1-6 GE/SW 93 CD	1868811614	E.24
CLJ C 1-3 GE/SW I MP	0252611653	E.17	CLJ C 1-3 WS/SW R CD	1568251038	E.19	CLJ C 1-6 GE/SW 44 CD	1868811565	E.23	CLJ C 1-6 GE/SW 93 MP	0252711614	E.22
CLJ C 1-3 GE/SW J CD	1568251655	E.19	CLJ C 1-3 WS/SW S CD	1568251039	E.19	CLJ C 1-6 GE/SW 44 MP	0252711565	E.21	CLJ C 1-6 GE/SW 94 CD	1868811615	E.24
CLJ C 1-3 GE/SW J MP	0252611655	E.17	CLJ C 1-3 WS/SW T CD	1568251040	E.19	CLJ C 1-6 GE/SW 45 CD	1868811566	E.23	CLJ C 1-6 GE/SW 94 MP	0252711615	E.22
CLJ C 1-3 GE/SW K CD	1568251657	E.19	CLJ C 1-3 WS/SW U CD	1568251041	E.19	CLJ C 1-6 GE/SW 45 MP	0252711566	E.21	CLJ C 1-6 GE/SW 95 CD	1868811616	E.24
CLJ C 1-3 GE/SW K MP	0252611657	E.17	CLJ C 1-3 WS/SW V CD	1568251042	E.19	CLJ C 1-6 GE/SW 46 CD	1868811567	E.23	CLJ C 1-6 GE/SW 95 MP	0252711616	E.22
CLJ C 1-3 GE/SW L CD	1568251659	E.19	CLJ C 1-3 WS/SW W CD	1568251043	E.19	CLJ C 1-6 GE/SW 46 MP	0252711567	E.21	CLJ C 1-6 GE/SW 96 CD	1868811617	E.24
CLJ C 1-3 GE/SW L MP	0252611659	E.17	CLJ C 1-3 WS/SW X CD	1568251054	E.19	CLJ C 1-6 GE/SW 47 CD	1868811568	E.23	CLJ C 1-6 GE/SW 96 MP	0252711617	E.22
CLJ C 1-3 GE/SW M CD	1568251661	E.19	CLJ C 1-3 WS/SW Y CD	1568251045	E.19	CLJ C 1-6 GE/SW 47 MP	0252711568	E.21	CLJ C 1-6 GE/SW 97 CD	1868811618	E.24
CLJ C 1-3 GE/SW M MP	0252611661	E.17	CLJ C 1-3 WS/SW Z CD	1568251046	E.19	CLJ C 1-6 GE/SW 48 CD	1868811569	E.23	CLJ C 1-6 GE/SW 97 MP	0252711618	E.22
CLJ C 1-3 GE/SW N CD	1568251663	E.19	CLJ C 1-30 SDR SG	1912660000	E.10	CLJ C 1-6 GE/SW 48 MP	0252711569	E.21	CLJ C 1-6 GE/SW 98 CD	1868811619	E.24
CLJ C 1-3 GE/SW N MP	0252611663	E.17	CLJ C 1-33 SDR SG	1912670000	E.10	CLJ C 1-6 GE/SW 49 CD	1868811570	E.23	CLJ C 1-6 GE/SW 98 MP	0252711619	E.22
CLJ C 1-3 GE/SW O CD	1568251665	E.20	CLJ C 1-39 SDR SG	1912680000	E.10	CLJ C 1-6 GE/SW 49 MP	0252711570	E.21	CLJ C 1-6 GE/SW 99 CD	1868811620	E.24
CLJ C 1-3 GE/SW O CD	1568251795	E.20	CLJ C 1-6 GE/NE CD	1868811687	E.8	CLJ C 1-6 GE/SW 50 CD	1868811571	E.23	CLJ C 1-6 GE/SW 99 MP	0252711620	E.22
CLJ C 1-3 GE/SW O CD	1568251736	E.20	CLJ C 1-6 GE/SW 01 CD	1868811522	E.23	CLJ C 1-6 GE/SW 50 MP	0252711571	E.21	CLJ C 1-6 GE/SW A1 CD	1868811726	E.25
CLJ C 1-3 GE/SW O MP	0252611665	E.17	CLJ C 1-6 GE/SW 01 MP	0252711522	E.21	CLJ C 1-6 GE/SW 51 CD	1868811572	E.23	CLJ C 1-6 GE/SW A1 MP	0252711726	E.22
CLJ C 1-3 GE/SW O MP	0252611695	E.17	CLJ C 1-6 GE/SW 02 CD	1868811523	E.23	CLJ C 1-6 GE/SW 51 MP	0252711572	E.21	CLJ C 1-6 GE/SW A2 CD	1868811727	E.25
CLJ C 1-3 GE/SW P CD	1568251667	E.19	CLJ C 1-6 GE/SW 02 MP	0252711523	E.21	CLJ C 1-6 GE/SW 52 CD	1868811573	E.23	CLJ C 1-6 GE/SW A2 MP	0252711727	E.22
CLJ C 1-3 GE/SW P MP	0252611667	E.17	CLJ C 1-6 GE/SW 03 CD	1868811524	E.23	CLJ C 1-6 GE/SW 52 MP	0252711573	E.21	CLJ C 1-6 GE/SW I1 CD	1868811739	E.25
CLJ C 1-3 GE/SW PET. CD	1568251747	E.20	CLJ C 1-6 GE/SW 03 MP	0252711524	E.21	CLJ C 1-6 GE/SW 53 CD	1868811574	E.23	CLJ C 1-6 GE/SW I2 CD	1868811740	E.25
CLJ C 1-3 GE/SW PET. MP	0252611747	E.17	CLJ C 1-6 GE/SW 04 CD	1868811525	E.23	CLJ C 1-6 GE/SW 53 MP	0252711574	E.21	CLJ C 1-6 GE/SW IC CD	1868811741	E.25
CLJ C 1-3 GE/SW O CD	1568251669	E.19	CLJ C 1-6 GE/SW 04 MP	0252711525	E.21	CLJ C 1-6 GE/SW 54 CD	1868811575	E.23	CLJ C 1-6 GE/SW L1 CD	1868811728	E.25
CLJ C 1-3 GE/SW Q MP	0252611669	E.17	CLJ C 1-6 GE/SW 05 CD	1868811526	E.23	CLJ C 1-6 GE/SW 54 MP	0252711575	E.21	CLJ C 1-6 GE/SW L1 MP	0252711728	E.22
CLJ C 1-3 GE/SW R CD	1568251671	E.19	CLJ C 1-6 GE/SW 05 MP	0252711526	E.21	CLJ C 1-6 GE/SW 55 CD	1868811576	E.23	CLJ C 1-6 GE/SW L2 CD	1868811729	E.25
CLJ C 1-3 GE/SW R MP	0252611671	E.17	CLJ C 1-6 GE/SW 06 CD	1868811527	E.23	CLJ C 1-6 GE/SW 55 MP	0252711576	E.21	CLJ C 1-6 GE/SW L2 MP	0252711729	E.22
CLJ C 1-3 GE/SW S CD	1568251673	E.19	CLJ C 1-6 GE/SW 06 MP	0252711527	E.21	CLJ C 1-6 GE/SW 56 CD	1868811577	E.23	CLJ C 1-6 GE/SW L3 CD	1868811730	E.25
CLJ C 1-3 GE/SW S MP	0252611673	E.17	CLJ C 1-6 GE/SW 07 CD	1868811528	E.23	CLJ C 1-6 GE/SW 56 MP	0252711577	E.21	CLJ C 1-6 GE/SW L3 MP	0252711730	E.22
CLJ C 1-3 GE/SW T CD	1568251676	E.19	CLJ C 1-6 GE/SW 07 MP	0252711528	E.21	CLJ C 1-6 GE/SW 57 CD	1868811578	E.23	CLJ C 1-6 GE/SW MP CD	1868811731	E.25
CLJ C 1-3 GE/SW T MP	0252611676	E.17	CLJ C 1-6 GE/SW 08 CD	1868811529	E.23	CLJ C 1-6 GE/SW 57 MP	0252711578	E.21	CLJ C 1-6 GE/SW PE CD	1868811733	E.25
CLJ C 1-3 GE/SW U CD	1568251679	E.19	CLJ C 1-6 GE/SW 08 MP	0252711529	E.21	CLJ C 1-6 GE/SW 58 CD	1868811579	E.23	CLJ C 1-6 GE/SW PE MP	0252711733	E.22
CLJ C 1-3 GE/SW U MP	0252611679	E.17	CLJ C 1-6 GE/SW 09 CD	1868811530	E.23	CLJ C 1-6 GE/SW 58 MP	0252711579	E.21	CLJ C 1-6 GE/SW U1 CD	1868811735	E.25
CLJ C 1-3 GE/SW V CD	1568251681	E.19	CLJ C 1-6 GE/SW 09 MP	0252711530	E.21	CLJ C 1-6 GE/SW 59 CD	1868811580	E.23	CLJ C 1-6 GE/SW U2 CD	1868811736	E.25
CLJ C 1-3 GE/SW V MP	0252611681	E.17	CLJ C 1-6 GE/SW 10 CD	1868811531	E.23	CLJ C 1-6 GE/SW 59 MP	0252711580	E.21	CLJ C 1-6 GE/SW U3 CD	1868811737	E.25
CLJ C 1-3 GE/SW W CD	1568251683	E.19	CLJ C 1-6 GE/SW 10 MP	0252711531	E.21	CLJ C 1-6 GE/SW 60 CD	1868811581	E.23	CLJ C 1-6 GE/SW UN CD	1868811738	E.25
CLJ C 1-3 GE/SW W MP	0252611683	E.17	CLJ C 1-6 GE/SW 11 CD	1868811532	E.23	CLJ C 1-6 GE/SW 60 MP	0252711581	E.21	CLJ C 1-6 GE/SW X1 CD	1868811150	E.25
CLJ C 1-3 GE/SW X CD	1568251687	E.19	CLJ C 1-6 GE/SW 11 MP	0252711532	E.21	CLJ C 1-6 GE/SW 61 CD	1868811582	E.23	CLJ C 1-6 GE/SW X2 CD	1868811151	E.25
CLJ C 1-3 GE/SW Y MP	0252611687	E.17	CLJ C 1-6 GE/SW 12 CD	1868811533	E.23	CLJ C 1-6 GE/SW 61 MP	0252711582	E.21	CLJ C 1-6 SDR CD	0252709999	E.9
CLJ C 1-3 GE/SW Y CD	1568251696	E.19	CLJ C 1-6 GE/SW 12 MP	0252711533	E.21	CLJ C 1-6 GE/SW 62 CD	1868811583	E.23	CLJ C 1-6 SDR SG	1912700000	E.10
CLJ C 1-3 GE/SW Y CD	0252611696	E.17	CLJ C 1-6 GE/SW 13 CD	1868811534	E.23	CLJ C 1-6 GE/SW 62 MP	0252711583	E.21	CLJ C 1-6 GE/SW PEN CD	1868811734	E.25
CLJ C 1-3 GE/SW Z CD	1568251698	E.19	CLJ C 1-6 GE/SW 13 MP	0252711534	E.21	CLJ C 1-6 GE/SW 63 CD	1868811584	E.23	CLJ C 1-6 GE/SW PEN MP	0252711734	E.22
CLJ C 1-3 GE/SW Z MP	0252611698	E.17	CLJ C 1-6 GE/SW 14 CD	1868811535	E.23	CLJ C 1-6 GE/SW 63 MP	0252711584	E.21	CLJ C 1-9 SDR CD	0252009999	E.9
CLJ C 1-3 GN NE CD	1568251688	E.8	CLJ C 1-6 GE/SW 14 MP	0252711535	E.21	CLJ C 1-6 GE/SW 64 CD	1868811585	E.23	CLJ C 1-9 SDR SG	1868819999	E.10
CLJ C 1-3 GN/WS 5 CD	1568251518	E.18	CLJ C 1-6 GE/SW 15 CD	1868811536	E.23	CLJ C 1-6 GE/SW 64 MP	0252711585	E.21	CLJ C 2-12 SDR SG	1873380000	E.10
CLJ C 1-3 GN/WS 5 MP	0252611518	E.17	CLJ C 1-6 GE/SW 15 MP	0252711536	E.21	CLJ C 1-6 GE/SW 65 CD	1868811586	E.23	CLJ C 2-15 SDR SG	1873390000	E.10
CLJ C 1-3 GR NE CD	1568251691	E.8	CLJ C 1-6 GE/SW 16 CD	1868811537	E.23	CLJ C 1-6 GE/SW 65 MP	0252711586	E.21	CLJ C 2-18 GE NE SG	1871831687	E.8
CLJ C 1-3 GR/WS 8 CD	1568251527	E.18	CLJ C 1-6 GE/SW 16 MP	0252711537	E.21	CLJ C 1-6 GE/SW 66 CD	1868811587	E.23	CLJ C 2-18 SDR SG	1871839999	E.10
CLJ C 1-3 GR/WS 8 MP	0252611527	E.16									

Type	Order No.	Page
CLI C 2.4 GE/SW 1 CD	1568261505	E.27
CLI C 2.4 GE/SW 1 MP	0251311505	E.26
CLI C 2.4 GE/SW 2 CD	1568261508	E.27
CLI C 2.4 GE/SW 2 MP	0251311508	E.26
CLI C 2.4 GE/SW 3 CD	1568261511	E.27
CLI C 2.4 GE/SW 3 MP	0251311511	E.26
CLI C 2.4 GE/SW 4 CD	1568261514	E.27
CLI C 2.4 GE/SW 4 MP	0251311514	E.25
CLI C 2.4 GE/SW 5 CD	1568261517	E.27
CLI C 2.4 GE/SW 5 MP	0251311517	E.26
CLI C 2.4 GE/SW 6 CD	1568261520	E.27
CLI C 2.4 GE/SW 6 MP	0251311520	E.26
CLI C 2.4 GE/SW 7 CD	1568261523	E.27
CLI C 2.4 GE/SW 7 MP	0251311523	E.26
CLI C 2.4 GE/SW 8 CD	1568261526	E.27
CLI C 2.4 GE/SW 8 MP	0251311526	E.26
CLI C 2.4 GE/SW 9 CD	1568261529	E.27
CLI C 2.4 GE/SW 9 MP	0251311529	E.26
CLI C 2.4 GE/SW A CD	1568261637	E.28
CLI C 2.4 GE/SW A MP	1568261697	E.28
CLI C 2.4 GE/SW B CD	1568261699	E.28
CLI C 2.4 GE/SW B MP	0251311637	E.26
CLI C 2.4 GE/SW A MP	0251311697	E.27
CLI C 2.4 GE/SW A MP	0251311699	E.27
CLI C 2.4 GE/SW AC CD	1568261752	E.28
CLI C 2.4 GE/SW AC MP	0251311752	E.27
CLI C 2.4 GE/SW A CD	1568261735	E.28
CLI C 2.4 GE/SW A MP	0251311735	E.27
CLI C 2.4 GE/SW B CD	1568261639	E.28
CLI C 2.4 GE/SW B MP	0251311639	E.26
CLI C 2.4 GE/SW C CD	1568261641	E.28
CLI C 2.4 GE/SW C MP	0251311641	E.26
CLI C 2.4 GE/SW D CD	1568261643	E.28
CLI C 2.4 GE/SW D MP	0251311643	E.26
CLI C 2.4 GE/SW E CD	1568261645	E.28
CLI C 2.4 GE/SW E MP	0251311645	E.26
CLI C 2.4 GE/SW ET CD	1568261746	E.28
CLI C 2.4 GE/SW ET MP	0251311746	E.27
CLI C 2.4 GE/SW F CD	1568261647	E.28
CLI C 2.4 GE/SW F MP	0251311647	E.26
CLI C 2.4 GE/SW G CD	1568261649	E.28
CLI C 2.4 GE/SW G MP	0251311649	E.26
CLI C 2.4 GE/SW H CD	1568261651	E.28
CLI C 2.4 GE/SW H MP	0251311651	E.26
CLI C 2.4 GE/SW I CD	1568261653	E.28
CLI C 2.4 GE/SW I MP	0251311653	E.26
CLI C 2.4 GE/SW J CD	1568261655	E.28
CLI C 2.4 GE/SW J MP	0251311655	E.26
CLI C 2.4 GE/SW K CD	1568261657	E.28
CLI C 2.4 GE/SW K MP	0251311657	E.26
CLI C 2.4 GE/SW L CD	1568261659	E.28
CLI C 2.4 GE/SW L MP	0251311659	E.26
CLI C 2.4 GE/SW M CD	1568261661	E.28
CLI C 2.4 GE/SW M MP	0251311661	E.26
CLI C 2.4 GE/SW N CD	1568261663	E.28
CLI C 2.4 GE/SW N MP	0251311663	E.26
CLI C 2.4 GE/SW O CD	1568261665	E.28
CLI C 2.4 GE/SW O MP	1568261695	E.28
CLI C 2.4 GE/SW P CD	1568261736	E.28
CLI C 2.4 GE/SW P MP	0251311665	E.26
CLI C 2.4 GE/SW Q CD	0251311685	E.26
CLI C 2.4 GE/SW Q MP	0251311685	E.26
CLI C 2.4 GE/SW R CD	1568261671	E.28
CLI C 2.4 GE/SW R MP	0251311671	E.26
CLI C 2.4 GE/SW S CD	1568261673	E.28
CLI C 2.4 GE/SW S MP	0251311673	E.26
CLI C 2.4 GE/SW T CD	1568261676	E.28
CLI C 2.4 GE/SW T MP	0251311676	E.26
CLI C 2.4 GE/SW U CD	1568261679	E.28
CLI C 2.4 GE/SW U MP	0251311679	E.26
CLI C 2.4 GE/SW V CD	1568261681	E.28
CLI C 2.4 GE/SW V MP	0251311681	E.26
CLI C 2.4 GE/SW W CD	1568261683	E.28
CLI C 2.4 GE/SW W MP	0251311683	E.26
CLI C 2.4 GE/SW X CD	1568261687	E.28
CLI C 2.4 GE/SW X MP	0251311687	E.26
CLI C 2.4 GE/SW Y CD	1568261696	E.28
CLI C 2.4 GE/SW Y MP	0251311696	E.26
CLI C 2.4 GE/SW Z CD	1568261698	E.28
CLI C 2.4 GE/SW Z MP	0251311698	E.26
CLI C 2.4 GN/WS 5 CD	1568261518	E.27
CLI C 2.4 GN/WS 5 MP	0251311518	E.25
CLI C 2.4 GR/SW 8 CD	1568261527	E.28
CLI C 2.4 GR/SW 8 MP	0251311527	E.25
CLI C 2.4 OR/SW 3 CD	1568261512	E.27
CLI C 2.4 OR/SW 3 MP	0251311512	E.25
CLI C 2.4 RT/WS 2 CD	1568261737	E.28
CLI C 2.4 RT/WS 2 MP	1568261509	E.27
CLI C 2.4 RT/WS 2 MP	0251311509	E.25
CLI C 2.4 SDR CD	1568269999	E.10
CLI C 2.4 SW/WS 0 CD	1568261503	E.27
CLI C 2.4 SW/WS 0 MP	0251311503	E.25

Type	Order No.	Page
CLI C 2.4 VI/WS 7 CD	1568261524	E.27
CLI C 2.4 VI/WS 7 MP	0251311524	E.25
CLI C 2.4 WS/WS - MP	0251311049	E.27
CLI C 2.4 WS/WS + MP	0251311048	E.27
CLI C 2.4 WS/WS 0 MP	0251311000	E.26
CLI C 2.4 WS/WS 1 MP	0251310001	E.26
CLI C 2.4 WS/WS 2 MP	0251310002	E.26
CLI C 2.4 WS/WS 3 MP	0251310003	E.26
CLI C 2.4 WS/WS 4 MP	0251310004	E.26
CLI C 2.4 WS/WS 5 MP	0251310005	E.26
CLI C 2.4 WS/WS 6 MP	0251310006	E.26
CLI C 2.4 WS/WS 7 MP	0251310007	E.26
CLI C 2.4 WS/WS 8 MP	0251310008	E.26
CLI C 2.4 WS/WS 9 CD	1568261530	E.27
CLI C 2.4 WS/WS 9 MP	0251310009	E.25
CLI C 2.4 WS/WS 9 MP	0251310009	E.26
CLI C 2.6 GE/SW L1 CD	1871901728	E.29
CLI C 2.6 GE/SW L1 MP	1871891728	E.29
CLI C 2.6 GE/SW L2 CD	1871901729	E.29
CLI C 2.6 GE/SW L2 MP	1871891729	E.29
CLI C 2.6 GE/SW L3 CD	1871901730	E.29
CLI C 2.6 GE/SW L3 MP	1871891730	E.29
CLI C 2.6 GE/SW L3 CD	1871901731	E.29
CLI C 2.6 GE/SW L3 MP	1871901731	E.29
CLI C 2.6 SDR CD	1871909999	E.10
CLI C 2.9 GE NE CD	1871971687	E.8
CLI C 2.9 GE/SW PEN CD	1871971734	E.29
CLI C 2.9 GE/SW PEN MP	1872031734	E.29
CLI C 2.9 SDR CD	1899240000	E.10
CLI C 2.9 SDR SG	1871979999	E.10
CLI C 3-12 SDR SG	1873420000	E.11
CLI C 3-15 SDR SG	1873430000	E.11
CLI C 3-18 SDR SG	1872679999	E.11
CLI C 3-21 SDR SG	1873410000	E.11
CLI C 3-24 SDR SG	1912770000	E.11
CLI C 3-27 SDR SG	1912780000	E.11
CLI C 3-30 SDR SG	1912790000	E.11
CLI C 3-33 SDR SG	1912800000	E.11
CLI C 3-36 SDR SG	1912810000	E.11
CLI C 3-39 SDR SG	1912820000	E.11
CLI C 3-6 BL/WS - MP	0253411741	E.31
CLI C 3-6 GE/SW / MP	0253411742	E.31
CLI C 3-6 GE/SW - MP	0253411740	E.31
CLI C 3-6 GE/SW . MP	0253411748	E.31
CLI C 3-6 GE/SW : MP	0253411750	E.31
CLI C 3-6 GE/SW + MP	0253411738	E.31
CLI C 3-6 GE/SW - MP	0253411751	E.31
CLI C 3-6 GE/SW 0 MP	0253411502	E.30
CLI C 3-6 GE/SW 1 MP	0253411505	E.30
CLI C 3-6 GE/SW 2 MP	0253411508	E.30
CLI C 3-6 GE/SW 3 MP	0253411511	E.30
CLI C 3-6 GE/SW 4 MP	0253411514	E.30
CLI C 3-6 GE/SW 5 MP	0253411517	E.30
CLI C 3-6 GE/SW 6 MP	0253411520	E.30
CLI C 3-6 GE/SW 7 MP	0253411523	E.30
CLI C 3-6 GE/SW 8 MP	0253411526	E.30
CLI C 3-6 GE/SW 9 MP	0253411529	E.30
CLI C 3-6 GE/SW A MP	0253411637	E.30
CLI C 3-6 GE/SW A MP	0253411697	E.31
CLI C 3-6 GE/SW A MP	0253411699	E.31
CLI C 3-6 GE/SW AC MP	0253411752	E.31
CLI C 3-6 GE/SW B MP	0253411639	E.30
CLI C 3-6 GE/SW C MP	0253411641	E.30
CLI C 3-6 GE/SW D MP	0253411643	E.30
CLI C 3-6 GE/SW E MP	0253411645	E.30
CLI C 3-6 GE/SW ET MP	0253411746	E.31
CLI C 3-6 GE/SW F MP	0253411647	E.30
CLI C 3-6 GE/SW G MP	0253411649	E.30
CLI C 3-6 GE/SW H MP	0253411651	E.30
CLI C 3-6 GE/SW I MP	0253411653	E.30
CLI C 3-6 GE/SW J MP	0253411655	E.30
CLI C 3-6 GE/SW K MP	0253411657	E.30
CLI C 3-6 GE/SW L MP	0253411659	E.30
CLI C 3-6 GE/SW M MP	0253411661	E.30
CLI C 3-6 GE/SW N MP	0253411663	E.30
CLI C 3-6 GE/SW O MP	0253411665	E.30
CLI C 3-6 GE/SW 0 MP	0253411695	E.31
CLI C 3-6 GE/SW 1 MP	0253411667	E.30
CLI C 3-6 GE/SW R MP	0253411671	E.30
CLI C 3-6 GE/SW S MP	0253411673	E.30
CLI C 3-6 GE/SW T MP	0253411676	E.30
CLI C 3-6 GE/SW U MP	0253411679	E.30
CLI C 3-6 GE/SW V MP	0253411681	E.30
CLI C 3-6 GE/SW W MP	0253411683	E.30
CLI C 3-6 GE/SW X MP	0253411687	E.30
CLI C 3-6 GE/SW Y MP	0253411696	E.30
CLI C 3-6 GE/SW Z MP	0253411698	E.30
CLI C 3-6 SDR SG	1872309999	E.11
CLI C 3-9 GE/SW A1 MP	0253511726	E.31
CLI C 3-9 GE/SW A2 MP	0253511727	E.31
CLI C 3-9 GE/SW L1 MP	0253511728	E.31
CLI C 3-9 GE/SW L2 MP	0253511729	E.31
CLI C 3-9 GE/SW L3 MP	0253511730	E.31
CLI C 3-9 GE/SW PE MP	0253511733	E.31
CLI C 3-9 GE/SW PEN MP	1872661733	E.31
CLI C 3-9 GE/SW SL MP	0253511735	E.31
CLI C 3-9 GE/SW X1 MP	0253511750	E.31
CLI C 3-9 GE/SW X2 MP	0253511751	E.31
CLI C 3-9 GE/SW X3 MP	0253511752	E.31

Type	Order No.	Page
CLI C 3-9 SDR SG	1872659999	E.11
CLI CD-BOX	1763290000	E.52
CLI F 1-20 WS/GE	1600740000	F.13
CLI F 2-17.5 WS/GE	1764050000	F.13
CLI M 2-12 SDR SG	1873450000	E.45
CLI M 2-15 SDR SG	1899260000	E.45
CLI M 2-18 SDR SG	1899230000	E.45
CLI M 2-21 SDR SG	1873460000	E.45
CLI M 2-24 SDR SG	1912860000	E.45
CLI M 2-25Q GE NE SG	1886531687	E.45
CLI M 2-25Q SDR SG	1579500000	E.45
CLI M 2-27 SDR SG	1912870000	E.45
CLI M 2-30 SDR SG	1912880000	E.45
CLI M 2-33 SDR SG	1912920000	E.45
CLI M 2-36 SDR SG	1912950000	E.45
CLI M 2-39 SDR SG	1912960000	E.45
CLI M 2-4 BL/WS - CD	1568301741	E.48
CLI M 2-4 BL/WS 6 CD	1568301521	E.48
CLI M 2-4 BL/WS 6 MP	1733651521	E.46
CLI M 2-4 BR/WS 1 CD	1568301506	E.48
CLI M 2-4 BR/WS 1 MP	1733651506	E.46
CLI M 2-4 GE NE CD	1568300001	E.45
CLI M 2-4 GE NE MP	1733650004	E.45
CLI M 2-4 GE/SW / CD	1568301742	E.48
CLI M 2-4 GE/SW / MP	1733651742	E.46
CLI M 2-4 GE/WS 5 MP	1568301740	E.48
CLI M 2-4 GE/WS - MP	1733651740	E.46
CLI M 2-4 GE/WS - CD	1568301748	E.48
CLI M 2-4 GE/WS . MP	1733651748	E.46
CLI M 2-4 GE/WS : MP	1568301521	E.48
CLI M 2-4 GE/WS + MP	1733651738	E.46
CLI M 2-4 GE/WS - MP	1568301751	E.48
CLI M 2-4 GE/WS - MP	1733651751	E.46
CLI M 2-4 GE/WS 0 CD	1568301502	E.49
CLI M 2-4 GE/WS 0 MP	1733651502	E.47
CLI M 2-4 GE/WS 1 CD	1568301505	E.49
CLI M 2-4 GE/WS 1 MP	1733651505	E.47
CLI M 2-4 GE/WS 2 CD	1568301508	E.49
CLI M 2-4 GE/WS 2 MP	1733651508	E.47
CLI M 2-4 GE/WS 3 CD	1568301511	E.49
CLI M 2-4 GE/WS 3 MP	1733651511	E.47
CLI M 2-4 GE/WS 4 CD	1568301514	E.48
CLI M 2-4 GE/WS 4 CD	1568301514	E.49
CLI M 2-4 GE/WS 4 MP	1733651514	E.46
CLI M 2-4 GE/WS 4 MP	1733651514	E.47
CLI M 2-4 GE/WS 5 CD	1568301517	E.49
CLI M 2-4 GE/WS 5 MP	1733651517	E.47
CLI M 2-4 GE/WS 6 CD	1568301520	E.49
CLI M 2-4 GE/WS 6 MP	1733651520	E.47
CLI M 2-4 GE/WS 7 CD	1568301523	E.49
CLI M 2-4 GE/WS 7 MP	1733651523	E.47
CLI M 2-4 GE/WS 8 CD	1568301526	E.49
CLI M 2-4 GE/WS 8 MP	1733651526	E.47
CLI M 2-4 GE/WS 9 CD	1568301529	E.49
CLI M 2-4 GE/WS 9 MP	1733651529	E.47
CLI M 2-4 GE/WS A CD	1568301637	E.49
CLI M 2-4 GE/WS A CD	1568301694	E.48
CLI M 2-4 GE/WS A CD	1568301699	E.48
CLI M 2-4 GE/WS A MP	1733651637	E.47
CLI M 2-4 GE/WS A MP	1733651697	E.46
CLI M 2-4 GE/WS A MP	1733651699	E.46
CLI M 2-4 GE/WS AC CD	1568301752	E.48
CLI M 2-4 GE/WS AC MP	1733651752	E.46
CLI M 2-4 GE/WS A CD	1568301735	E.48
CLI M 2-4 GE/WS B CD	1568301639	E.49
CLI M 2-4 GE/WS B MP	1733651639	E.47
CLI M 2-4 GE/WS C CD	1568301641	E.49
CLI M 2-4 GE/WS C MP	1733651641	E.47
CLI M 2-4 GE/WS D CD	1568301643	E.49
CLI M 2-4 GE/WS D MP	1733651643	E.47
CLI M 2-4 GE/WS E CD	1568301645	E.49
CLI M 2-4 GE/WS E MP	1733651645	E.47
CLI M 2-4 GE/WS ET CD	1568301746	E.48
CLI M 2-4 GE/WS ET MP	1733651746	E.46
CLI M 2-4 GE/WS F CD	1568301647	E.49
CLI M 2-4 GE/WS F MP	1733651647	E.47
CLI M 2-4 GE/WS G CD	1568301649	E.49
CLI M 2-4 GE/WS G MP	1733651649	E.47
CLI M 2-4 GE/WS H CD	1568301651	E.49
CLI M 2-4 GE/WS H MP	1733651651	E.47
CLI M 2-4 GE/WS I CD	1568301653	E.49
CLI M 2-4 GE/WS I MP	1733651653	E.47
CLI M 2-4 GE/WS J CD	1568301655	E.49
CLI M 2-4 GE/WS J MP	1733651655	E.47</

Type	Order No.	Page	Type	Order No.	Page	Type	Order No.	Page	Type	Order No.	Page
CLI 0 20-3 GE/SW - MP	0648101740	E.42	CLI R 02-3 GE/SW 4	0560001513	E.33	CLI R 1-3 VI/WS 7	0572901523	E.35	DEK 5 GW 18	0522660018	E.3
CLI 0 20-3 GE/SW + MP	0648101738	E.42	CLI R 02-3 GE/SW 5	0560001516	E.33	CLI R 1-3 WS/ SW 9	0572901529	E.35	DEK 5 GW 19	0522660019	E.3
CLI 0 20-3 GE/SW 0 MP	0648101502	E.41	CLI R 02-3 GE/SW 6	0560001519	E.33	CLI RH 20-02 CLI R 02	0563700000	E.51	DEK 5 GW 2	0522660002	E.3
CLI 0 20-3 GE/SW 1 MP	0648101505	E.41	CLI R 02-3 GE/SW 7	0560001522	E.33	CLI RH 20-10 CLI R 10	0563600000	E.51	DEK 5 GW 20	0522660020	E.3
CLI 0 20-3 GE/SW 2 MP	0648101508	E.41	CLI R 02-3 GE/SW 8	0560001525	E.33	CLI RS 3 MDCLI C 02	0559200000	E.51	DEK 5 GW 21	0522660021	E.3
CLI 0 20-3 GE/SW 3 MP	0648101511	E.41	CLI R 02-3 GE/SW 9	0560001528	E.33	CLI RS 4 MDCLI C1+02	0559300000	E.51	DEK 5 GW 3	0522660003	E.3
CLI 0 20-3 GE/SW 4 MP	0648101514	E.41	CLI R 02-3 GE/SW A	0560001638	E.34	CLI RS 5 MDCLI C 1	0648300000	E.51	DEK 5 GW 4	0522660004	E.3
CLI 0 20-3 GE/SW 5 MP	0648101517	E.41	CLI R 02-3 GE/SW A	0560001698	E.34	CLI T 02-12	1764060000	F.12	DEK 5 GW 5	0522660005	E.3
CLI 0 20-3 GE/SW 6 MP	0648101520	E.41	CLI R 02-3 GE/SW B	0560001640	E.34	CLI T 02-15	1764070000	F.12	DEK 5 GW 6	0522660006	E.3
CLI 0 20-3 GE/SW 7 MP	0648101523	E.41	CLI R 02-3 GE/SW C	0560001642	E.34	CLI T 02-18	1764140000	F.12	DEK 5 GW 7	0522660007	E.3
CLI 0 20-3 GE/SW 8 MP	0648101526	E.41	CLI R 02-3 GE/SW D	0560001644	E.34	CLI T 02-20	1764150000	F.12	DEK 5 GW 8	0522660008	E.3
CLI 0 20-3 GE/SW 9 MP	0648101529	E.41	CLI R 02-3 GE/SW E	0560001646	E.34	CLI T 02-30	1889580000	F.12	DEK 5 GW 9	0522660009	E.3
CLI 0 20-3 GE/SW A MP	0648101637	E.41	CLI R 02-3 GE/SW F	0560001648	E.34	CLI T 1-12	1764190000	F.12	DEK 5 GW A	0522761021	E.3
CLI 0 20-3 GE/SW A MP	0648101697	E.42	CLI R 02-3 GE/SW G	0560001650	E.34	CLI T 1-15	1764200000	F.12	DEK 5 GW B	0522761022	E.3
CLI 0 20-3 GE/SW A MP	0648101699	E.42	CLI R 02-3 GE/SW H	0560001652	E.34	CLI T 1-18	1764210000	F.12	DEK 5 GW ERDE	0576261202	E.3
CLI 0 20-3 GE/SW B MP	0648101639	E.41	CLI R 02-3 GE/SW I	0560001654	E.34	CLI T 1-20	1764220000	F.12	DEK 5 GW ERDE I.K.R.	0576261203	E.3
CLI 0 20-3 GE/SW C MP	0648101641	E.41	CLI R 02-3 GE/SW J	0560001656	E.34	CLI T 1-30	1889560000	F.12	DEK 5 GW F	0522761026	E.3
CLI 0 20-3 GE/SW D MP	0648101643	E.41	CLI R 02-3 GE/SW K	0560001658	E.34	CLI T 2-12	1764230000	F.12	DEK 5 GW L	0522761032	E.3
CLI 0 20-3 GE/SW E MP	0648101645	E.41	CLI R 02-3 GE/SW L	0560001660	E.34	CLI T 2-15	1764240000	F.12	DEK 5 GW L1	0522361075	E.3
CLI 0 20-3 GE/SW F MP	0648101647	E.41	CLI R 02-3 GE/SW M	0560001662	E.34	CLI T 2-18	1764250000	F.12	DEK 5 GW L2	0522361076	E.3
CLI 0 20-3 GE/SW G MP	0648101649	E.41	CLI R 02-3 GE/SW N	0560001664	E.34	CLI T 2-20	1764260000	F.12	DEK 5 GW L3	0522361077	E.3
CLI 0 20-3 GE/SW H MP	0648101651	E.41	CLI R 02-3 GE/SW O	0560001666	E.34	CLI T 2-30	1889570000	F.12	DEK 5 GW N	0522761034	E.3
CLI 0 20-3 GE/SW I MP	0648101653	E.41	CLI R 02-3 GE/SW P	0560001695	E.34	CLI T 3-12	1764270000	F.12	DEK 5 GW O	0522761035	E.3
CLI 0 20-3 GE/SW J MP	0648101655	E.41	CLI R 02-3 GE/SW Q	0560001668	E.34	CLI T 3-15	1764280000	F.12	DEK 5 GW PE	0537261187	E.3
CLI 0 20-3 GE/SW K MP	0648101657	E.41	CLI R 02-3 GE/SW R	0560001670	E.34	CLI T 3-18	1764290000	F.12	DEK 5 GW R	0522761038	E.3
CLI 0 20-3 GE/SW L MP	0648101659	E.41	CLI R 02-3 GE/SW R	0560001672	E.34	CLI T 3-20	1764300000	F.12	DEK 5 GW S	0522761039	E.3
CLI 0 20-3 GE/SW M MP	0648101661	E.41	CLI R 02-3 GE/SW S	0560001675	E.34	CLI T 3-30	1889550000	F.12	DEK 5 GW T	0522761040	E.3
CLI 0 20-3 GE/SW N MP	0648101663	E.41	CLI R 02-3 GE/SW T	0560001678	E.34	CLI TM 10-33	1763270000	F.13	DEK 5 GW U	0522761041	E.3
CLI 0 20-3 GE/SW O MP	0648101665	E.41	CLI R 02-3 GE/SW U	0560001680	E.34	CLI TM 20-33	1763280000	F.13	DEK 5 GW V	0522761042	E.3
CLI 0 20-3 GE/SW P MP	0648101695	E.42	CLI R 02-3 GE/SW V	0560001682	E.34	CLI TM 20-66	1763390000	F.13	DEK 5 GW W	0522761043	E.3
CLI 0 20-3 GE/SW P MP	0648101667	E.41	CLI R 02-3 GE/SW W	0560001684	E.34				DEK 5 GW X	0522761044	E.3
CLI 0 20-3 GE/SW Q MP	0648101669	E.41	CLI R 02-3 GE/SW X	0560001693	E.34				DEK 5/3,5 MC FSZ 101-110	1762320101	E.3
CLI 0 20-3 GE/SW R MP	0648101671	E.41	CLI R 02-3 GE/SW Y	0560001697	E.34				DEK 5/3,5 MC FSZ 1-10	1762320001	E.3
CLI 0 20-3 GE/SW S MP	0648101673	E.41	CLI R 02-3 GE/SW Z	0560001699	E.34	DEK 5 FS 101-150	0473560101	E.3	DEK 5/3,5 MC FSZ 111-120	1762320111	E.3
CLI 0 20-3 GE/SW T MP	0648101676	E.41	CLI R 02-3 GN/WS 5	0560001518	E.33	DEK 5 FS 1-50	0473560001	E.3	DEK 5/3,5 MC FSZ 121-130	1762320111	E.3
CLI 0 20-3 GE/SW U MP	0648101679	E.41	CLI R 02-3 GR/SW 8	0560001527	E.33	DEK 5 FS 151-200	0473560151	E.3	DEK 5/3,5 MC FSZ 21-30	1762320121	E.3
CLI 0 20-3 GE/SW V MP	0648101681	E.41	CLI R 02-3 OR/SW 3	0560001512	E.33	DEK 5 FS 201-250	0473560201	E.3	DEK 5/3,5 MC FSZ 31-40	1762320031	E.3
CLI 0 20-3 GE/SW W MP	0648101683	E.41	CLI R 02-3 RT/WS +	0560001739	E.35	DEK 5 FS 51-100	0473560051	E.3	DEK 5/3,5 MC FSZ 41-50	1762320041	E.3
CLI 0 20-3 GE/SW X MP	0648101687	E.41	CLI R 02-3 RT/WS 2	0560001509	E.33	DEK 5 FSZ 1-10	0460660001	E.3	DEK 5/3,5 MC FSZ 51-60	1762320051	E.3
CLI 0 20-3 GE/SW Y MP	0648101696	E.41	CLI R 02-3 SDR	0560009999	E.32	DEK 5 FSZ 11-20	0460660011	E.3	DEK 5/3,5 MC FSZ 61-70	1762320061	E.3
CLI 0 20-3 GE/SW Z MP	0648101698	E.41	CLI R 02-3 SW/WS 0	0560001503	E.33	DEK 5 FSZ 21-30	0460660021	E.3	DEK 5/3,5 MC FSZ 71-80	1762320071	E.3
CLI 0 20-3 SDR MP	0648109999	E.39	CLI R 02-3 VI/WS 7	0560001524	E.33	DEK 5 FSZ 31-40	0460660031	E.3	DEK 5/3,5 MC FSZ 81-90	1762320081	E.3
CLI 0 30-3 GE NE MP	0689800000	E.39	CLI R 02-3 WS/ SW 9	0560001530	E.33	DEK 5 FSZ 41-50	0460660041	E.3	DEK 5/3,5 MC FSZ 91-100	1762320091	E.3
CLI 0 30-3 GE/SW - MP	0648201740	E.43	CLI R 1 F. CLI C 1-3	0532100000	E.51	DEK 5 FSZ 51-60	0460660051	E.3	DEK 5/3,5 MC FSZ 91-100	1762320091	E.3
CLI 0 30-3 GE/SW + MP	0648201738	E.43	CLI R 1 3 BL NE	0572900002	E.32	DEK 5 FSZ 61-70	0460660061	E.3	DEK 5/3,5 MC NE GE	1369480000	F.6
CLI 0 30-3 GE/SW 0 MP	0648201502	E.42	CLI R 1 3 BL/WS -	0572901741	E.36	DEK 5 FSZ 71-80	0460660071	E.3	DEK 5/3,5 MC NE WS	1755270000	C.27
CLI 0 30-3 GE/SW 1 MP	0648201505	E.42	CLI R 1 3 BL/WS 6	0572901520	E.35	DEK 5 FSZ 81-90	0460660081	E.3	DEK 5/3,5 MC NE WS	1755270000	F.6
CLI 0 30-3 GE/SW 2 MP	0648201508	E.42	CLI R 1 3 BL/WS N	0572901746	E.36	DEK 5 FSZ 91-100	0460660091	E.3	DEK 5/3,5 MC SDR	1767130000	C.27
CLI 0 30-3 GE/SW 3 MP	0648201511	E.42	CLI R 1 3 BR/WS 1	0572901505	E.35	DEK 5 FW 1,3,5...99	1358460000	E.3	DEK 5/3,5 MM BP WS	2619760000	D.11
CLI 0 30-3 GE/SW 4 MP	0648201514	E.42	CLI R 1 3 GE NE	0572901687	E.32	DEK 5 FW 101-150	0473460101	E.3	DEK 5/3,5 MM BP WS	2619760000	F.6
CLI 0 30-3 GE/SW 5 MP	0648201517	E.42	CLI R 1 3 GE/SW -	0572901740	E.36	DEK 5 FW 1-50	0473460001	E.3	DEK 5/3,5 MM WS	2007100000	D.11
CLI 0 30-3 GE/SW 6 MP	0648201520	E.42	CLI R 1 3 GE/SW .	0572901749	E.36	DEK 5 FW 151-200	0473460151	E.3	DEK 5/3,5 PLUS MC NE WS	2003750000	C.27
CLI 0 30-3 GE/SW 7 MP	0648201523	E.42	CLI R 1 3 GE/SW /	0572901743	E.36	DEK 5 FW 2,4...100	1358560000	E.3	DEK 5/3,5 PLUS MC SDR	2003750000	F.6
CLI 0 30-3 GE/SW 8 MP	0648201526	E.42	CLI R 1 3 GE/SW +	0572901738	E.36	DEK 5 FW 201-250	0473460201	E.3	DEK 5/3,5 PLUS MC SDR	2007790000	C.27
CLI 0 30-3 GE/SW 9 MP	0648201529	E.42	CLI R 1 3 GE/SW 0	0572901503	E.35	DEK 5 FW 251-300	0473460251	E.3	DEK 5/30 MC NE WS	1951920000	C.33
CLI 0 30-3 GE/SW A MP	0648201637	E.43	CLI R 1 3 GE/SW 1	0572901506	E.35	DEK 5 FW 301-350	0473460301	E.3	DEK 5/30 MC NE WS	1951920000	F.4
CLI 0 30-3 GE/SW A MP	0648201697	E.42	CLI R 1 3 GE/SW 2	0572901509	E.35	DEK 5 FW 351-400	0473460351	E.3	DEK 5/30 MC NE WS	1951920000	F.5
CLI 0 30-3 GE/SW A MP	0648201699	E.43	CLI R 1 3 GE/SW 3	0572901512	E.35	DEK 5 FW 401-450	0473460401	E.3	DEK 5/30 MC NE WS	1025680000	C.33
CLI 0 30-3 GE/SW B MP	0648201639	E.43	CLI R 1 3 GE/SW 4	0572901515	E.35	DEK 5 FW 451-500	0473460451	E.3	DEK 5/5 MC NE GE	1609801693	C.28
CLI 0 30-3 GE/SW C MP	0648201641	E.43	CLI R 1 3 GE/SW 5	0572901518	E.35	DEK 5 FW 501-550	0473460501	E.3	DEK 5/5 MC NE BL	1609801687	C.28
CLI 0 30-3 GE/SW D MP	0648201643	E.43	CLI R 1 3 GE/SW 6	0572901521	E.35	DEK 5 FW 51-100	0473460051	E.3	DEK 5/5 MC NE GN	1609801688	C.28
CLI 0 30-3 GE/SW E MP	0648201645	E.43	CLI R 1 3 GE/SW 7	0572901524	E.35	DEK 5 FW 551-600	0473460551	E.3	DEK 5/5 MC NE GR	1609801691	C.28
CLI 0 30-3 GE/SW ET MP	0648201746	E.43	CLI R 1 3 GE/SW 8	0572901527	E.35	DEK 5 FW 601-650	0473460601	E.3	DEK 5/5 MC NE OR	1238340000	C.28
CLI 0 30-3 GE/SW F MP	0648201647	E.43	CLI R 1 3 GE/SW 9	0572901530	E.35	DEK 5 FW 651-700	0473460651	E.3	DEK 5/5 MC NE RT	1609801686	C.28
CLI 0 30-3 GE/SW G MP	0648201649	E.43	CLI R 1 3 GE/SW A	0572901638	E.36	DEK 5 FW 701-750	0473460701	E.3	DEK 5/5 MC NE WS	1609801044	F.22
CLI 0 30-3 GE/SW H MP	0648201651	E.43	CLI R 1 3 GE/SW A	0572901698	E.36	DEK 5 FW 751-800	0473460751	E.3	DEK 5/5 MC NE WS	1609801044	F.4
CLI 0 30-3 GE/SW I MP	0648201653	E.43	CLI R 1 3 GE/SW B	0572901640	E.36	DEK 5 FW 801-850	0473460801	E.3	DEK 5/5 MC NE WS	1609801044	F.5
CLI 0 30-3 GE/SW I MP	0648201655	E.43	CLI R 1 3 GE/SW C	0572901642	E.36	DEK 5 FW 851-900	0473460851	E.3	DEK 5/5 MC NE WS	1609801044	F.6
CLI 0 30-3 GE/SW K MP	0648201657	E.43	CLI R 1 3 GE/SW D	0572901644	E.36	DEK 5 FW 901-950	0473460901	E.3	DEK 5/5 MC NE WS	1609801044	F.8
CLI 0 30-3 GE/SW L MP	0648201659	E.43	CLI R 1 3 GE/SW E	0572901646	E.36	DEK 5 FWZ 1,3,5-19	0235860000	E.3	DEK 5/5 MC NE WS	1609801044	F.8
CLI 0 30-3 GE/SW M MP	0648201661	E.43	CLI R 1 3 GE/SW ET	0572901745	E.36	DEK 5 FWZ 1-10	0523060001	E.3	DEK 5/5 MC SDR	1609810000	C.28
CLI 0 30-3 GE/SW N MP	0648201663	E.43	CLI R 1 3 GE/SW F	0572901648	E.36	DEK 5 FWZ 11-20	0523060011	E.3	DEK 5/5 MM BP WS	2619770000	D.11
CLI 0 30-3 GE/SW O MP	0648201665	E.43	CLI R 1 3 GE/SW G	0572901650	E.36	DEK 5 FWZ 2,4,6-20	0236160000	E.3	DEK 5/5 MM WS	2007110000	D.11
CLI 0 30-3 GE/SW P MP	0648201695	E.43	CLI R 1 3 GE/SW H	0572901652	E.36	DEK 5 FWZ 21,23,25-39	0235960000	E.3	DEK 5/5 MM WS	2007110000	F.22
CLI 0 30-3 GE/SW Q MP	0648201667	E.43	CLI R 1 3 GE/SW I	0572901654	E.36	DEK 5 FWZ 21-30	0523060021	E.3	DEK 5/5 MM WS	2007110000	F.5
CLI 0 30-3 GE/SW R MP	0648201669	E.43	CLI R 1 3 GE/SW J	0572901656	E.36	DEK 5 FWZ 22,24,26-40	0236260000	E.3	DEK 5/5 MM WS	2007110000	F.6
CLI 0 30-3 GE/SW S MP	0648201671	E.43	CLI R 1 3 GE/SW K	0572901658	E.36	DEK 5 FWZ 31-40	052306003				





Type	Order No.	Page	Type	Order No.	Page	Type	Order No.	Page	Type	Order No.	Page
ESO 8/20 DIN A4 GE	1919900000	F.17	FF-FIMT 3X 54	2556720000	G.9	HS-FR 3.2-6.4/25 MM W	2621620000	D.28	HSS H.8.5-25.4 EL Y30M	1505830000	D.29
ESO 8/20 DIN A4 WS	1919890000	F.17	FF-FIMT 3X 55	2556730000	G.9	HS-FR 3.2-6.4/25 MM Y	2621630000	D.28	HSSHF 1.2-2.4 EL B30M	1562840000	D.31
ESO 8/20 P DIN A4 GE	1919880000	F.17	FF-FIMT 4X 54	2556790000	G.9	HS-FR 3.2-6.4/50 MM W	2621800000	D.28	HSSHF 1.2-2.4 EL G30M	1562940000	D.31
ESO 8/20 P DIN A4 WS	1919870000	F.17	FF-FIMT 4X 55	2556800000	G.9	HS-FR 3.2-6.4/50 MM Y	2621810000	D.28	HSSHF 1.2-2.4 EL R30M	1562740000	D.31
ES0/SCHS1 500X12,5X0,3	0139000000	F.21	FF-FIMT 6X 54	2567310000	G.9	HS-FR 4.8-9.5/25 MM W	2621640000	D.28	HSSHF 1.2-2.4 EL SW30M	2518740000	D.31
ET S7-12/50 GE-A4	1804800000	D.45	FF-FIMT 6X 55	2567050000	G.9	HS-FR 4.8-9.5/25 MM Y	2621650000	D.28	HSSHF 1.2-2.4 EL W13M	1423330000	D.30
ET S7-12/50-TU-A4	1865440000	D.45	FF-SL 65 55/230V BK	2557010000	G.7	HS-FR 4.8-9.5/50 MM W	2621820000	D.28	HSSHF 1.2-2.4 EL W30M	1513240000	D.31
ET S7-200-TU-A4-1	1045500000	D.45	FF-SL 65 55/230V GY	2557000000	G.7	HS-FR 4.8-9.5/50 MM Y	2621830000	D.28	HSSHF 1.2-2.4 EL Y13M	1423220000	D.30
ET S7-200-TU-A4-2	1045490000	D.45	FF-SL 67 55/230V BK	2557040000	G.7	HS-FR 6.4-12.7/25 MM W	2621660000	D.28	HSSHF 1.2-2.4 EL Y30M	1513140000	D.31
ET S7-300-GE-A4-1	1821020000	D.45	FF-SL 67 55/230V GY	2557030000	G.7	HS-FR 6.4-12.7/25 MM Y	2621670000	D.28	HSSHF 1.2-2.4 EL Y75M	1562640000	D.32
ET S7-300-GE-A4-2	1847650000	D.45	FH-TCO 1000W 230V BK	2558070000	G.12	HS-FR 6.4-12.7/50 MM W	2621840000	D.28	HSSHF 1.6-3.2 EL B30M	1562850000	D.31
ET S7-300-TU-A4-1	1865450000	D.45	FH-TCO 1200W 230V BK	2558080000	G.12	HS-FR 6.4-12.7/50 MM Y	2621850000	D.28	HSSHF 1.6-3.2 EL G30M	1562950000	D.31
ET S7-300-TU-A4-2	1865460000	D.45	FH-TCO 200W 230V BK	2558010000	G.12	HS-FR 9.5-19.1/25 MM W	2621680000	D.28	HSSHF 1.6-3.2 EL R30M	1562750000	D.31
ET S7-400-GE-A4-1	1821040000	D.45	FH-TCO 250W 230V	2557990000	G.12	HS-FR 9.5-19.1/25 MM Y	2621690000	D.28	HSSHF 1.6-3.2 EL SW30M	2518920000	D.31
ET S7-400-GE-A4-2	1821030000	D.45	FH-TCO 300W 230V BK	2558020000	G.12	HS-FR 9.5-19.1/50 MM W	2621860000	D.28	HSSHF 1.6-3.2 EL W13M	1423340000	D.30
ET S7-400-GE-A4-3	1847640000	D.45	FH-TCO 400W 230V	2558000000	G.12	HS-FR 9.5-19.1/50 MM Y	2621870000	D.28	HSSHF 1.6-3.2 EL W30M	1513250000	D.31
ET S7-400-TU-A4-1	1865470000	D.45	FH-TCO 400W 230V BK	2558030000	G.12	HS-HF 1.2-2.4/12 MM W	2526230000	D.26	HSSHF 1.6-3.2 EL Y13M	1423230000	D.30
ET S7-400-TU-A4-2	1865480000	D.45	FH-TCO 500W 230V BK	2558040000	G.12	HS-HF 1.2-2.4/12 MM Y	2526240000	D.26	HSSHF 1.6-3.2 EL Y30M	1513150000	D.31
ET S7-400-TU-A4-3	1865490000	D.45	FH-TCO 650W 230V BK	2558050000	G.12	HS-HF 1.2-2.4/25 MM W	2437830000	D.27	HSSHF 1.6-3.2 EL Y75M	1562650000	D.32
ETO CC 15/17 TRANSPAR.	1880850000	C.159	FH-TCO 800W 230V BK	2558060000	G.12	HS-HF 1.2-2.4/25 MM Y	2437840000	D.27	HSSHF 12.7-25.4 EL B30M	1562930000	D.31
ETO CC 15/27 TRANSPAR.	1880810000	C.159	FH-TH 1000W 230V BK	2558150000	G.13	HS-HF 1.2-2.4/50 MM W	2437850000	D.27	HSSHF 12.7-25.4 EL G30M	1563040000	D.31
ETO CC 15/49 TRANSPAR.	1880830000	C.160	FH-TH 1200W 230V BK	2558160000	G.13	HS-HF 1.2-2.4/50 MM Y	2437860000	D.27	HSSHF 12.7-25.4 EL R30M	1562830000	D.31
ETO CC 15/60 TRANSPAR.	1880840000	C.161	FH-TH 200W 230V BK	2558090000	G.13	HS-HF 1.6-3.2/12 MM W	2526250000	D.26	HSSHF 12.7-25.4 EL SW30M	2518980000	D.31
ETO CC 30/60 TRANSPAR.	1934440000	C.162	FH-TH 300W 230V BK	2558100000	G.13	HS-HF 1.6-3.2/12 MM Y	2526260000	D.26	HSSHF 12.7-25.4 EL W10M	1423410000	D.29
ETO SM 22/22 TRANSPAR.	1880720000	C.150	FH-TH 400W 230V BK	2558110000	G.13	HS-HF 1.6-3.2/25 MM W	2437870000	D.27	HSSHF 12.7-25.4 EL W30M	1513330000	D.31
ETO SM 27/12.5	1720580000	C.151	FH-TH 500W 230V BK	2558120000	G.13	HS-HF 1.6-3.2/25 MM Y	2437880000	D.27	HSSHF 12.7-25.4 EL Y10M	1423290000	D.29
ETO SM 27/18 TRANSPAR.	1720590000	C.151	FH-TH 650W 230V BK	2558130000	G.13	HS-HF 1.6-3.2/50 MM W	2437890000	D.27	HSSHF 12.7-25.4 EL Y30M	1513230000	D.31
ETO SM 27/27	1805840000	C.152	FH-TH 800W 230V BK	2558140000	G.13	HS-HF 1.6-3.2/50 MM Y	2437900000	D.27	HSSHF 12.7-25.4 EL Y50M	1562730000	D.31
ETO SM 27/8	1720570000	C.150				HS-HF 12.7-25.4/25 MM W	2437910000	D.27	HS-SHF 2.4-4.8 EL SW30M	2518930000	D.31
EXRV 4.5	2562700000	G.27				HS-HF 12.7-25.4/25 MM Y	2437920000	D.27	HSSHF 2.4-4.8 EL B30M	1562870000	D.31
EXRV 6.5	2562690000	G.27				HS-HF 12.7-25.4/50 MM W	2437930000	D.27	HSSHF 2.4-4.8 EL G30M	1562970000	D.31
EXRV-T 4.5	2562720000	G.27				HS-HF 12.7-25.4/50 MM Y	2437940000	D.27	HSSHF 2.4-4.8 EL R30M	1562770000	D.31
EXRV-T 6.5	2562710000	G.27				HS-HF 19.5-38.1/25 MM W	2437950000	D.27	HSSHF 2.4-4.8 EL W13M	1423350000	D.30
						HS-HF 19.5-38.1/25 MM Y	2437960000	D.27	HS-SHF 2.4-4.8 EL W30M	1513270000	D.31
						HS-HF 19.5-38.1/50 MM W	2437970000	D.27	HS-SHF 2.4-4.8 EL Y13M	1423240000	D.30
						HS-HF 19.5-38.1/50 MM Y	2437980000	D.27	HS-SHF 2.4-4.8 EL Y30M	1513170000	D.31
						HS-HF 2.4-4.8/12 MM W	2526270000	D.26	HS-SHF 2.4-4.8 EL Y75M	1562670000	D.32
						HS-HF 2.4-4.8/12 MM Y	2526280000	D.26	HSSHF 2.4-4.8 EL B30M	1562880000	D.31
						HS-HF 2.4-4.8/25 MM W	2437990000	D.27	HSSHF 3.2-6.4 EL G30M	1562980000	D.31
						HS-HF 2.4-4.8/25 MM Y	2438000000	D.27	HSSHF 3.2-6.4 EL R30M	1562780000	D.31
						HS-HF 2.4-4.8/50 MM W	2438010000	D.27	HSSHF 3.2-6.4 EL SW30M	2518940000	D.31
						HS-HF 2.4-4.8/50 MM Y	2438020000	D.27	HSSHF 3.2-6.4 EL W13M	1423360000	D.30
						HS-HF 3.2-6.4/12 MM W	2526290000	D.26	HSSHF 3.2-6.4 EL W30M	1513280000	D.31
						HS-HF 3.2-6.4/12 MM Y	2526300000	D.26	HSSHF 3.2-6.4 EL Y13M	1423250000	D.30
						HS-HF 3.2-6.4/25 MM B	2438030000	D.27	HSSHF 3.2-6.4 EL Y30M	1513180000	D.31
						HS-HF 3.2-6.4/25 MM W	2438040000	D.27	HSSHF 3.2-6.4 EL Y75M	1562680000	D.32
						HS-HF 3.2-6.4/25 MM Y	2438050000	D.27	HSSHF 4.8-9.5 EL B30M	1562890000	D.31
						HS-HF 3.2-6.4/50 MM W	2438060000	D.27	HSSHF 4.8-9.5 EL G30M	1562990000	D.31
						HS-HF 3.2-6.4/50 MM Y	2438070000	D.27	HSSHF 4.8-9.5 EL R30M	1562790000	D.31
						HS-HF 4.8-9.5/12 MM W	2526310000	D.26	HSSHF 4.8-9.5 EL SW30M	2518950000	D.31
						HS-HF 4.8-9.5/12 MM Y	2526320000	D.26	HSSHF 4.8-9.5 EL W13M	1423370000	D.30
						HS-HF 4.8-9.5/25 MM B	2438080000	D.27	HSSHF 4.8-9.5 EL W30M	1513290000	D.31
						HS-HF 4.8-9.5/25 MM W	2438090000	D.27	HSSHF 4.8-9.5 EL Y13M	1423260000	D.30
						HS-HF 4.8-9.5/25 MM Y	2438100000	D.27	HSSHF 4.8-9.5 EL Y30M	1513190000	D.31
						HS-HF 4.8-9.5/50 MM W	2438110000	D.27	HSSHF 4.8-9.5 EL Y75M	1562690000	D.32
						HS-HF 4.8-9.5/50 MM Y	2438120000	D.27	HS-HF 6.4-12.7 EL B30M	1562900000	D.31
						HS-HF 6.4-12.7/12 MM W	2526330000	D.26	HS-HF 6.4-12.7 EL G30M	1563020000	D.31
						HS-HF 6.4-12.7/12 MM Y	2526340000	D.26	HS-HF 6.4-12.7 EL R30M	1562800000	D.31
						HS-HF 6.4-12.7/25 MM B	2438130000	D.27	HS-HF 6.4-12.7 EL SW30M	2518960000	D.31
						HS-HF 6.4-12.7/25 MM W	2438140000	D.27	HS-HF 6.4-12.7 EL W13M	1423380000	D.30
						HS-HF 6.4-12.7/25 MM Y	2438150000	D.27	HS-HF 6.4-12.7 EL W30M	1513300000	D.31
						HS-HF 6.4-12.7/50 MM W	2438160000	D.27	HS-HF 6.4-12.7 EL Y13M	1423270000	D.30
						HS-HF 6.4-12.7/50 MM Y	2438170000	D.27	HS-HF 6.4-12.7 EL Y30M	1513200000	D.31
						HS-HF 9.5-19.1/25 MM R	2438180000	D.27	HS-HF 6.4-12.7 EL Y75M	1562700000	D.32
						HS-HF 9.5-19.1/25 MM W	2438190000	D.27	HSSHF 9.5-19.1 EL B30M	1562920000	D.31
						HS-HF 9.5-19.1/25 MM Y	2438200000	D.27	HSSHF 9.5-19.1 EL G30M	1563030000	D.31
						HS-HF 9.5-19.1/50 MM W	2438210000	D.27	HSSHF 9.5-19.1 EL R30M	1562820000	D.31
						HS-HF 9.5-19.1/50 MM Y	2438220000	D.27	HS-HF 9.5-19.1 EL SW30M	2518970000	D.31
						HSS 0.8-2.4 EL W13M	1489620000	D.29	HS-SHF 9.5-19.1 EL W10M	1423390000	D.29
						HSS 0.8-2.4 EL W30M	1505840000	D.29	HS-SHF 9.5-19.1 EL W30M	1513200000	D.31
						HSS 0.8-2.4 EL Y13M	1489530000	D.29	HS-SHF 9.5-19.1 EL Y10M	1423280000	D.29
						HSS 0.8-2.4 EL Y30M	1505760000	D.29	HS-SHF 9.5-19.1 EL Y30M	1513220000	D.31
						HSS 1.0-3.2 EL W13M	1489630000	D.29	HS-SHF 9.5-19.1 EL Y50M	1562720000	D.31
						HSS 1.0-3.2 EL W30M	1505850000	D.29	HS-SHF 9.5-19.1 EL Y75M	1562680000	D.32
						HSS 1.0-3.2 EL Y13M	1489540000	D.29	HS-SHF 12.7-25.4 EL B30M	1562930000	D.31
						HSS 1.0-3.2 EL Y30M	1505770000	D.29	HS-SHF 12.7-25.4 EL G30M	1563040000	D.31
						HSS 1.6-4.8 EL W13M	1489640000	D.29	HS-SHF 12.7-25.4 EL R30M	1562800000	D.31
						HSS 1.6-4.8 EL W30M	1505860000	D.29	HS-SHF 12.7-25.4 EL SW30M	2518960000	D.31
						HSS 1.6-4.8 EL Y13M	1489550000	D.29	HS-SHF 12.7-25.4 EL W13M	1423380000	D.30
						HSS 1.6-4.8 EL Y30M	1505780000	D.29	HS-SHF 12.7-25.4 EL W30M	1513300000	D.31
						HSS 2.1-6.4 EL W13M	1489650000	D.29	HS-SHF 12.7-25.4 EL Y13M	1423270000	D.30
						HSS 2.1-6.4 EL W30M	1505870000	D.29	HS-SHF 12.7-25.4 EL Y30M	1513200000	D.31
						HSS 2.1-6.4 EL Y13M	1489560000	D.29	HS-SHF 12.7-25.4 EL Y75M	1562700000	D.32
						HSS 2.1-6.4 EL Y30M	1505790000	D.29	HS-SHF 12.7-25.4 EL Y75M	1562920000	D.31
						HSS 3.2-9.5 EL W13M	1489660000	D.29	HS-SHF 12.7-25.4 EL Y75M	1562920000	D.31
						HSS 3.2-9.5 EL W30M	1505880000	D.29	HS-SHF 12.7-25.4 EL Y75M	1562920000	D.31
						HSS 3.2-9.5 EL Y13M	1489570000	D.29	HS-SHF 12.7-25.4 EL Y75M	1562920000	D.31
						HSS 3.2-9.5 EL Y30M	1505890000	D.29	HS-SHF 12.7-25.4 EL Y75M	1562920000	D.31
						HSS 4.2-12.7 EL W13M	1489670000	D.29	HS-SHF 12.7-25.4 EL Y75M	1562920000	D.31
						HSS 4.2-12.7 EL W30M	1505890000	D.29	HS-SHF 12.7-		

Type	Order No.	Page
INLAY CC-M UNIVERSAL	1341120000	C.173
INLAY CC-M UNIVERSAL	1341120000	C.175
INLAY CC-M UNIVERSAL	1341120000	C.176
INLAY CC-M UNIVERSAL	1341120000	C.177
INLAY CC-M UNIVERSAL	1341120000	C.179
INLAY SFX-M 11/60	1341110000	C.118
INLAY SFX-M 11/60	1341110000	C.118
INLAY SFX-M 17/60	1500330000	C.118

## K

KABELBINDERZANGE RT-1	1296000000	G.33
KSW 2.5 &lt; 100MM SONDR.	1629920000	E.61
KSW 2.5 &lt; 150MM SONDR.	1629940000	E.61
KSW 2.5 24/3,5 1-24	1652200001	E.61
KSW 2.5 8/5,08 1-8	1630100001	E.61
KSW 2.5 8/5,08 9-16	1630100009	E.61
KSW 2.5 &lt; 50MM SDR	1629900000	E.61
KSW 2.5 EL WS 50M	1812660000	E.61
KSW 4 &lt; 100MM SDR	1629930000	E.61
KSW 4 &lt; 150MM SONDR.	1629950000	E.61
KSW 4 &lt; 50MM SDR	1629910000	E.61
KSW 4 10/5,08 W 1-10	1705820001	E.61
KSW 4 16/3,5 1-16	1630150001	E.61
KSW 4 16/5,08 1-16	1630160001	E.61
KSW 4 16/5,08 17-32	1630160017	E.61
KSW 4 24/5,08 1-24	1630180001	E.61
KSW 4 8/5,08 1-8	1630200001	E.61
KSW 4.0 EL WS 50M	1812670000	E.61

## L

LM MT300 105/105 SI	1975160000	D.46
LM MT300 105/148 SI	1724170001	D.46
LM MT300 105/148 WS	1724171044	D.46
LM MT300 12/6 GE	1882910000	D.46
LM MT300 15/4.6 GE	1724141687	D.46
LM MT300 15/4.6 SI	1724140001	D.46
LM MT300 15/4.6 WS	1724141044	D.46
LM MT300 15/6 GE	1686361687	D.46
LM MT300 15/6 SI	1686360001	D.46
LM MT300 15/6 WS	1686361044	D.46
LM MT300 15/9 GE	1882890000	D.46
LM MT300 17/6 GE	1835820000	D.46
LM MT300 17/9 GE	1724151687	D.46
LM MT300 17/9 SI	1724150001	D.46
LM MT300 17/9 WS	1724151044	D.46
LM MT300 18/6.5 GE	1749321687	D.46
LM MT300 18/6.5 SI	1749320001	D.46
LM MT300 18/6.5 WS	1749321044	D.46
LM MT300 19/6.3 GE	1835830000	D.46
LM MT300 20/8 GE	1686381687	D.46
LM MT300 20/8 SI	1686380001	D.46
LM MT300 20/8 WS	1686381044	D.46
LM MT300 202/12 GE	1915320000	D.46
LM MT300 210/148 GE	1724181687	D.46
LM MT300 210/148 SI	1724180001	D.46
LM MT300 210/297 GE	1686441687	D.46
LM MT300 210/297 SI	1686440001	D.46
LM MT300 210/297 WS	1686441044	D.46
LM MT300 25.4/12.7 GE	1686391687	D.46
LM MT300 25.4/12.7 SI	1686390001	D.46
LM MT300 25.4/12.7 WS	1686391044	D.46
LM MT300 26/10 GE	1686401687	D.46
LM MT300 26/10 SI	1686400001	D.46
LM MT300 26/10 WS	1686401044	D.46
LM MT300 27/18 SI	1873810000	D.46
LM MT300 27/8 GE	1861510000	D.46
LM MT300 30/20 GE	1724161687	D.46
LM MT300 30/20 SI	1724160001	D.46
LM MT300 30/20 WS	1724161044	D.46
LM MT300 35/16 WS	1140460000	D.46
LM MT300 40/6 WS	1760461044	D.46
LM MT300 56/22 GE	1686421687	D.46
LM MT300 56/22 SI	1686420001	D.46
LM MT300 56/22 WS	1686421044	D.46
LM MT300 60/36 GE	1686431687	D.46
LM MT300 60/36 SI	1686430001	D.46
LM MT300 60/36 WS	1686431044	D.46
LM MT300 89/34 WS	1003400000	D.46
LM WO 15/140 WS	1773880000	D.23
LM WO 15/70 WS	1759871044	D.23
LM WO 18/34 GE	1695711687	D.23
LM WO 18/34 WS	1695711044	D.23
LM WO 23/55 GE	1695721687	D.23
LM WO 23/55 WS	1695721044	D.23
LM WO 25.4/57 GE	1768390000	D.23
LM WO 25.4/57 WS	1768380000	D.23
LM WO 25.4/95 WS	1768400000	D.23
LM WO 25/140 GE	1712491687	D.23
LM WO 25/140 WS	1712491044	D.23
LM WO 25/68 GE	1695731687	D.23
LM WO 25/68 WS	1695731044	D.23
LM WO 36/93 GE	1695741687	D.23
LM WO 36/93 WS	1695741044	D.23
LM WO 37/25 GE	1768430000	D.23

Type	Order No.	Page
MARKO-C. 25X25X25 B/DR.	1700530001	E.58
MARKO-C. 50X50X50 B/DR.	1700540001	E.58
MARKO-C. 100X100X100 B/DR	1700550001	E.58
MARKO-C.200X200X200 B/DR	1700560001	E.58
MCP AP BASIC	1139880000	C.15
MCP AP LABELS	1924370000	C.13
MCP AP LABELS	1924370000	C.15
MCP AP PLUS	1924360000	C.13
MCP AP SF4-6	1924310000	C.13
MCP AP SF4-6	1924310000	C.15
MCP BASIC 2	2438520000	C.15
MCP BASIC 2 COVER	2439080000	C.15
MCP EP	1935130000	C.15
MCP EP SFC 3	1058090000	C.13
MCP EP SFC 3	1058090000	C.15
MCP PLUS 2	2439510000	C.13
MCP PLUS 2 COVER	2493070000	C.13
MF 10/10 MC NE WS	1866760000	C.63
MF 10/10 MC SDR	1856770000	C.63
MF 10/5 CABUR MC NE WS	1864510000	C.59
MF 10/5 MC NE WS	1677160000	C.58
MF 10/5 MC SDR	1677170000	C.58
MF 10/5 MM BP WS	2712150000	D.12
MF 10/5 MM WS	2519170000	D.12
MF 10/6 MC NE WS	1677220000	C.61
MF 10/6 MC SDR	1677230000	C.61
MF 10/6 MM BP WS	2712160000	D.12
MF 10/6 MM WS	2519180000	D.12
MF 10/8 MC NE WS	1868440000	C.62
MF 10/8 MC SDR	1868430000	C.62
MF 10/8 MM BP WS	2712170000	D.12
MF 10/8 MM WS	2519190000	D.12
MF 12/5 CABUR MC NE WS	1864520000	C.60
MF 12/5 MC CABUR SDR	1038670000	C.60
MF 12/5 MC NE WS	1677180000	C.59
MF 12/5 MC SDR	1677190000	C.59
MF 4/5.2 MC NE WS	1907530000	C.60
MF 4/5.2 MC SDR	1038690000	C.60
MF 5/10 MC NE WS	1945050000	C.63
MF 5/10 MC SDR	1038730000	C.63
MF 5/12 MC NE WS	1250090000	C.64
MF 5/12 MC SDR	1250080000	C.64
MF 5/3.5 MC NE WS	1521010000	C.56
MF 5/3.5 MC SDR	1525840000	C.56
MF 5/4 MC NE WS	1724189000	C.56
MF 5/4 MC SDR	1877670000	C.56
MF 5/5 MC NE WS	1816250000	C.57
MF 5/5 MC SDR	1816320000	C.57
MF 5/5 MM WS	2519200000	D.12
MF 5/6 MC NE WS	1816260000	C.61
MF 5/6 MC SDR	1816330000	C.61
MF 5/6 MM WS	2519210000	D.12
MF 5/7.5 MC NE WS	1877680000	C.62
MF 5/7.5 MC SDR	1877660000	C.62
MF 8/5 MC NE WS	1677140000	C.58
MF 8/5 MC SDR	1677150000	C.58
MF 8/5 MM WS	2518500000	D.12
MF-ABB 12/5 MC NE WS	2047320000	C.78
MF-ABB 12/5 MC SDR	2047460000	C.78
MF-ABB 12/6 MC NE WS	2047340000	C.78
MF-ABB 12/6 MC SDR	2047510000	C.78
MF-ABB 12/8 MC NE WS	2047350000	C.79
MF-ABB 12/8 MC SDR	2047520000	C.79
MFF 10/6 MC NE GE	1957340000	C.65
MFF 10/6 MC NE WS	1856780000	C.65
MFF 10/6 MC SDR	1856790000	C.65
MFF 9/4 MC NE WS	1877720000	C.65
MFF 9/4 MC SDR	1877700000	C.65
MF-SI 10/5 MC NE WS	1889190000	C.75
MF-SI 10/5 MC SDR	1889170000	C.75
MF-SI 10/5.6 MC NE WS	1889800000	C.77
MF-SI 10/5.6 MC SDR	1889790000	C.77
MF-SI 10/6 MC NE WS	1889260000	C.76
MF-SI 10/6 MC SDR	1889250000	C.76
MF-SI 7/5.6.5 MC NE WS	1889780000	C.77
MF-SI 7/5.6.5 MC SDR	1889770000	C.77
MF-SI 8/5 MC NE WS	1889180000	C.75
MF-SI 8/5 MC SDR	1886270000	C.75
MF-SI 8/6 MC NE WS	1889240000	C.76
MF-SI 8/6 MC SDR	1889230000	C.76
MF-W 5/5 MINI MC NE BL	1924270000	C.71
MF-W 5/5 MINI MC NE GE	1924280000	C.71
MF-W 5/5 MINI MC NE GN	1924290000	C.71
MF-W 5/5 MINI MC NE RT	1924260000	C.71
MF-W 5/5 MINI MC NE WS	1816240000	C.71
MF-W 5/5 MINI MC SDR	1816310000	C.71
MF-W 5/5 MINI MM WS	2519220000	D.12
MF-W 9/3.5F MC NE WS	1521040000	C.66
MF-W 9/3.5F MC SDR	1525830000	C.66
MF-W 9/4 MC NE WS	1877730000	C.66
MF-W 9/4 MC SDR	1877710000	C.66
MF-W 9/4.2F MC NE WS	1011430000	C.67
MF-W 9/4.2F MC SDR	1038750000	C.67
MF-W 9/5 F MM WS	2519240000	D.12
MF-W 9/5 MC NE GE	1027310000	C.68
MF-W 9/5 MC NE WS	1816270000	C.68
MF-W 9/5 MC SDR	1816340000	C.68

## M

Type	Order No.	Page
MF-W 9/5 MM WS	2519230000	D.12
MF-W 9/5.2 F MM WS	2519250000	D.12
MF-W 9/5.2F MC NE WS	1011410000	C.69
MF-W 9/5.2F MC SDR	1038760000	C.69
MF-W 9/5F MC NE GR	1045980000	C.68
MF-W 9/5F MC NE WS	1816280000	C.68
MF-W 9/5F MC SDR	1816350000	C.68
MF-W 9/6 MC NE WS	1816290000	C.70
MF-W 9/6 MC SDR	1816360000	C.70
MF-W 9/6.2F MC NE WS	1011420000	C.70
MF-W 9/6.2F MC SDR	1038770000	C.70
MF-W 12/5 MC NE WS	1692270000	C.73
MF-W 12/5 MC SDR	1692280000	C.73
MF-W 12/6 MC NE WS	1692290000	C.74
MF-W 12/6 MC SDR	1692300000	C.74
MF-W 12/6 MC NE WS	1716800000	C.72
MF-W 12/6 MC SDR	1716810000	C.72
MF-W 9/5 MC NE WS	1716840000	C.72
MF-W 9/5 MC SDR	1716850000	C.72
MF-W 9/6 MC NE WS	1716820000	C.73
MF-W 9/6 MC SDR	1716830000	C.73
MM PLUS ROLLER MF	2661610000	D.7
MM PLUS ROLLER MF-W	2661620000	D.7
MM PLUS ROLLER TB	2661600000	D.7
M-PRINT PRO	1905490000	B.4
M-PRINT PRO	1905490000	C.11

## P

PAGETAB 15/9	1686160000	E.58
PAGETAB 19/11	1686170000	E.58
PAGETAB 20/8	1686180000	E.58
PAGETAB 28/11	1686190000	E.58
PAGETAB 38/11	1686200000	E.58
PAGETAB 56/22	1686210000	E.58
PAGETAB 60/35	1686220000	E.58
P-CLEANER	1924330000	C.13
P-CLEANER	1924330000	C.15
PINK 2.0	1924340000	C.13
PINK 2.0	1924340000	C.15
PJ ADV TNAW	1338710000	C.11
PJ ADV TNTK INK C	1338680000	C.11
PJ ADV TNTK INK K	1338690000	C.11
PJ ADV TNTK INK M	1338670000	C.11
PJ ADV TNTK INK SET	1338720000	C.11
PJ ADV TNTK INK Y	1338650000	C.11
PJ CON FLUID SET	2715650000	C.11
PJ CON INK C	2715610000	C.11
PJ CON INK K	2715640000	C.11
PJ CON INK M	2715620000	C.11
PJ CON INK SET	2715600000	C.11
PJ CON INK Y	2715630000	C.11
PJ CON TEXTILE COVER	2715670000	C.11
PJ CON WASTE PAD	2715660000	C.11
PJ CON WIFI STICK	2715680000	C.11
PLOTTER PEN 0.25 P-INK	1920640000	C.13
PLOTTER PEN 0.25 P-INK	1920640000	C.15
PLOTTER PEN 0.35 P-INK	1920650000	C.13
PLOTTER PEN 0.35 P-INK	1920650000	C.15
PLOTTER PEN 0.50 P-INK	1005710000	C.13
PLOTTER PEN 0.50 P-INK	1005710000	C.15
PLOTTER PEN 0.70 P-INK	1011450000	C.13
PLOTTER PEN 0.70 P-INK	10114500	

Type	Order No.	Page	Type	Order No.	Page	Type	Order No.	Page	Type	Order No.	Page
SCT-C 4.6/200	1015250000	G.32	SFC 0/12 MC NE WS	1813130000	C.111	SFX 10/23 MC NE WS V2	1852390000	C.109	SM 19/42 K MC NE GR	1248640000	C.149
SCT-C 4.6/360	1015270000	G.32	SFC 0/12 MC SDR	1813180000	C.111	SFX 10/23 MC SDR V2	1852380000	C.109	SM 19/42 K MC NE WS	1248620000	C.149
SCT-C 4.6/520	1015280000	G.32	SFC 0/21 MC NE BL	1813220000	C.111	SFX 10/60 S MC NE BL	1248840000	C.109	SM 19/42 K MC SDR	1248560000	C.149
SCT-C 4.6/680	1015290000	G.32	SFC 0/21 MC NE GE	1813210000	C.111	SFX 10/60 S MC NE GE	1248820000	C.109	SM 22/22 K MC NE GE	1131830000	C.150
SCT-C 4.6/840	1015300000	G.32	SFC 0/21 MC NE RT	1813200000	C.111	SFX 10/60 S MC NE GE V0	2009900000	C.109	SM 22/22 K MC NE GR	1014650000	C.150
SCT-C 7.9/200	1015310000	G.32	SFC 0/21 MC NE WS	1813190000	C.111	SFX 10/60 S MC NE RT	1248830000	C.109	SM 22/22 K MC NE SI	1877590000	C.150
SCT-C 7.9/360	1015320000	G.32	SFC 0/21 MC SDR	1813230000	C.111	SFX 10/60 S MC NE WS	1248810000	C.109	SM 22/22 K MC NE WS	1877570000	C.150
SCT-C 7.9/520	1015330000	G.32	SFC 0/30 MC NE BL	1813270000	C.111	SFX 10/60 S MC NE WS V0	2009890000	C.109	SM 22/22 K MC SDR	1877580000	C.150
SCT-C 7.9/680	1015340000	G.32	SFC 0/30 MC NE GE	1813260000	C.111	SFX 10/60 S MC SDR	1248750000	C.109	SM 22/22 MM GE	2535620000	D.36
SCT-C 7.9/840	1015350000	G.32	SFC 0/30 MC NE RT	1813250000	C.111	SFX 11/60 MC NE BL	1051870000	C.109	SM 22/22 MM GR	2535630000	D.36
SERV-P. DIAM16 L1 SW/WS	1707350001	E.58	SFC 0/30 MC NE WS	1813240000	C.111	SFX 11/60 MC NE GE	1860150000	C.109	SM 22/22 MM WS	2535610000	D.36
SERV-P. DIAM16 L2 SW/WS	1707350002	E.58	SFC 0/30 MC SDR	1813280000	C.111	SFX 11/60 MC NE GE V0	1076890000	C.109	SM 27/12.5 K MC NE GE	1131810000	C.151
SERV-P. DIAM16 L3 SW/WS	1707350003	E.58	SFC 1/12 MC NE BL	1747320002	C.111	SFX 11/60 MC NE RT	1963850000	C.109	SM 27/12.5 K MC NE GR	1027830000	C.151
SERV-P. DIAM16 N BL/WS	1707350004	E.58	SFC 1/12 MC NE GE	1747320004	C.111	SFX 11/60 MC NE WS	1860120000	C.109	SM 27/12.5 K MC NE SI	1713720000	C.151
SERV-P. DIAM16 PE GE/GN	1707350006	E.58	SFC 1/12 MC NE RT	1747320003	C.111	SFX 11/60 MC NE WS V0	1432750000	C.109	SM 27/12.5 K MC NE WS	1699880000	C.151
SERV-P. DIAM16ERDE GE/GN	1707350005	E.58	SFC 1/12 MC NE WS	1747320001	C.111	SFX 11/60 MC SDR	1860140000	C.109	SM 27/12.5 K MC SDR	1699890000	C.151
SF 0/12 MC NE BL V2	1919220000	C.107	SFC 1/12 MC SDR	1752720000	C.111	SFX 11/60 MM BL	2519060000	D.17	SM 27/12.5 MC NE GE	1131860000	C.151
SF 0/12 MC NE GE V2	1919210000	C.107	SFC 1/21 MC NE BL	1779080002	C.111	SFX 11/60 MM BP GE	2712120000	D.17	SM 27/12.5 MC NE GR	1079490000	C.151
SF 0/12 MC NE RT V2	1919230000	C.107	SFC 1/21 MC NE GE	1779080004	C.111	SFX 11/60 MM BP WS	2712110000	D.17	SM 27/12.5 MC NE SI	1713700000	C.151
SF 0/12 MC NE WS V2	1919240000	C.107	SFC 1/21 MC NE RT	1779080003	C.111	SFX 11/60 MM GE	2005400000	D.17	SM 27/12.5 MC NE WS	1699840000	C.151
SF 0/12 MC SDR V2	1919250000	C.107	SFC 1/21 MC NE WS	1779080001	C.111	SFX 11/60 MM GN	2519050000	D.17	SM 27/12.5 MM GE	2006510000	D.36
SF 0/21 MC NE BL V2	1918510000	C.107	SFC 1/21 MC SDR	1779090000	C.111	SFX 11/60 MM RT	2519040000	D.17	SM 27/12.5 MM GN	2006550000	D.36
SF 0/21 MC NE GE V2	1918480000	C.107	SFC 1/30 MC NE BL	1805720000	C.111	SFX 11/60 MM SW	2518650000	D.17	SM 27/12.5 MM GR	2006520000	D.36
SF 0/21 MC NE RT V2	1918490000	C.107	SFC 1/30 MC NE GE	1805730000	C.111	SFX 11/60 MM WS	2005340000	D.17	SM 27/12.5 MM RT	2006540000	D.36
SF 0/21 MC NE WS V2	1918500000	C.107	SFC 1/30 MC NE RT	1805740000	C.111	SFX 14/23 MC NE BL V2	1852450000	C.109	SM 27/12.5 MM SW	2006530000	D.36
SF 0/21 MC SDR V2	1918470000	C.107	SFC 1/30 MC NE WS	1805760000	C.111	SFX 14/23 MC NE GE V2	1852410000	C.109	SM 27/12.5 MM WS	2006500000	D.36
SF 00/12 MC NE BL V2	1919270000	C.107	SFC 1/30 MC SDR	1805750000	C.111	SFX 14/23 MC NE RT V2	1852420000	C.109	SM 27/12.5 SDR	1699850000	C.151
SF 00/12 MC NE GE V2	1919260000	C.107	SFC 2.5/12 MC NE BL	1062030000	C.111	SFX 14/23 MC NE WS V2	1852440000	C.109	SM 27/18 K MC NE GE	1915340000	C.151
SF 00/12 MC NE RT V2	1919280000	C.107	SFC 2.5/12 MC NE GE	1062010000	C.111	SFX 14/23 MC SDR V2	1852430000	C.109	SM 27/18 K MC NE GR	1073340000	C.151
SF 00/12 MC NE WS V2	1919290000	C.107	SFC 2.5/12 MC NE RT	1062020000	C.111	SFX 30/60 MC NE BL	1369540000	C.109	SM 27/18 K MC NE SI	1906120000	C.151
SF 00/12 MC SDR V2	1919300000	C.107	SFC 2.5/12 MC NE WS	1062000000	C.111	SFX 30/60 MC NE GE	1083240000	C.109	SM 27/18 K MC NE SI	1713760000	C.151
SF 00/21 MC NE BL V2	1918590000	C.107	SFC 2.5/12 MC SDR	1062040000	C.111	SFX 30/60 MC NE RT	1369550000	C.109	SM 27/18 K MC NE WS	1707270000	C.151
SF 00/21 MC NE GE V2	1918600000	C.107	SFC 2.5/21 MC NE BL	1062090000	C.111	SFX 30/60 MC NE WS	1083230000	C.109	SM 27/18 K MC NE WS	1707280000	C.151
SF 00/21 MC NE RT V2	1918570000	C.107	SFC 2.5/21 MC NE GE	1062070000	C.111	SFX 30/60 MC SDR	1083260000	C.109	SM 27/18 MC NE GE	1131850000	C.151
SF 00/21 MC NE WS V2	1918580000	C.107	SFC 2.5/21 MC NE RT	1062080000	C.111	SFX 30/60 MM BL	2519140000	D.17	SM 27/18 MC NE GN	1346130000	C.151
SF 00/21 MC SDR V2	1918530000	C.107	SFC 2.5/21 MC NE WS	1062050000	C.111	SFX 30/60 MM GE	2005420000	D.17	SM 27/18 MC NE GR	1014640000	C.151
SF 1/12 MC NE BL V2	1919360000	C.107	SFC 2.5/21 MC SDR	1062110000	C.111	SFX 30/60 MM GN	2519110000	D.17	SM 27/18 MC NE RT	1906110000	C.151
SF 1/12 MC NE GE V2	1919340000	C.107	SFC 2/12 MC NE BL	1758320002	C.111	SFX 30/60 MM RT	2519130000	D.17	SM 27/18 MC NE SI	1713740000	C.151
SF 1/12 MC NE RT V2	1919320000	C.107	SFC 2/12 MC NE GE	1758320004	C.111	SFX 30/60 MM SW	2519120000	D.17	SM 27/18 MC NE WS	1699860000	C.151
SF 1/12 MC NE WS V2	1919390000	C.107	SFC 2/12 MC NE RT	1758320003	C.111	SFX 30/60 MM WS	2005360000	D.17	SM 27/18 MC SDR	1699870000	C.151
SF 1/12 MC SDR V2	1919420000	C.107	SFC 2/12 MC NE WS	1758320001	C.111	SFX 9/24 MC NE BL V2	1852500000	C.109	SM 27/18 MM GE	2006300000	D.36
SF 1/21 MC NE BL V2	1918620000	C.107	SFC 2/12 MC SDR	1763480000	C.111	SFX 9/24 MC NE GE V2	1852460000	C.109	SM 27/18 MM GN	2006380000	D.36
SF 1/21 MC NE GE V2	1918610000	C.107	SFC 2/21 MC NE BL	1805770000	C.111	SFX 9/24 MC NE RT V2	1852470000	C.109	SM 27/18 MM GR	2006340000	D.36
SF 1/21 MC NE RT V2	1918600000	C.107	SFC 2/21 MC NE GE	1805780000	C.111	SFX 9/24 MC NE WS V2	1852490000	C.109	SM 27/18 MM RT	2006360000	D.36
SF 1/21 MC NE WS V2	1918630000	C.107	SFC 2/21 MC NE RT	1805790000	C.111	SFX 9/24 MC SDR V2	1852480000	C.109	SM 27/18 MM SW	2006320000	D.36
SF 1/21 MC SDR V2	1918640000	C.107	SFC 2/21 MC NE WS	1805810000	C.111	SFX 9/24 MM BL	2519100000	D.17	SM 27/18 MM WS	2006280000	D.36
SF 2/12 MC NE BL V2	1919480000	C.107	SFC 2/21 MC SDR	1805800000	C.111	SFX 9/24 MM BP GE	2712100000	D.17	SM 27/18 MC NE GN	1428180000	C.153
SF 2/12 MC NE GE V2	1919470000	C.107	SFC 2/30 MC NE BL	1805820000	C.111	SFX 9/24 MM BP WS	2712090000	D.17	SM 27/18.22 K MC NE WS	1428170000	C.153
SF 2/12 MC NE RT V2	1919460000	C.107	SFC 2/30 MC NE GE	1805830000	C.111	SFX 9/24 MM GE	2005380000	D.17	SM 27/18.22 K MC SDR	1433870000	C.153
SF 2/12 MC NE WS V2	1919490000	C.107	SFC 2/30 MC NE RT	1805850000	C.111	SFX 9/24 MM GN	2519080000	D.17	SM 27/18.22 MM GE	2005810000	D.37
SF 2/12 MC SDR V2	1919500000	C.107	SFC 2/30 MC NE WS	1805870000	C.111	SFX 9/24 MM RT	2519090000	D.17	SM 27/18.22 MM GN	2005920000	D.37
SF 2/21 MC NE BL V2	1918700000	C.107	SFC 2/30 MC SDR	1805860000	C.111	SFX 9/24 MM SW	2519070000	D.17	SM 27/18.22 MM GR	2005860000	D.37
SF 2/21 MC NE GE V2	1918660000	C.107	SFC 3/12 MC NE BL	1025250000	C.111	SFX 9/24 MM WS	2005320000	D.17	SM 27/18.22 MM RT	2005900000	D.37
SF 2/21 MC NE RT V2	1918670000	C.107	SFC 3/12 MC NE GE	1025230000	C.111	SFX 9/24 S MC NE BL	1323480000	C.109	SM 27/18.22 MM SW	2005880000	D.37
SF 2/21 MC NE WS V2	1918690000	C.107	SFC 3/12 MC NE RT	1025240000	C.111	SFX 9/24 S MC NE GE	1323450000	C.109	SM 27/18.22 MM WS	2005840000	D.37
SF 2/21 MC SDR V2	1918650000	C.107	SFC 3/12 MC NE WS	1025220000	C.111	SFX 9/24 S MC NE GE V0	2009940000	C.109	SM 27/27 K MC NE GE	1131800000	C.152
SF 3/12 MC NE BL V2	1919550000	C.107	SFC 3/12 MC SDR	1025550000	C.111	SFX 9/24 S MC NE RT	1323470000	C.109	SM 27/27 K MC NE GR	1079520000	C.152
SF 3/12 MC NE GE V2	1919520000	C.107	SFC 3/21 MC NE BL	1025300000	C.111	SFX 9/24 S MC NE WS	1323440000	C.109	SM 27/27 K MC NE SI	1782990000	C.152
SF 3/12 MC NE RT V2	1919530000	C.107	SFC 3/21 MC NE GE	1025270000	C.111	SFX 9/24 S MC NE WS V0	2009930000	C.109	SM 27/27 K MC NE WS	1783000000	C.152
SF 3/12 MC NE WS V2	1919540000	C.107	SFC 3/21 MC NE RT	1025290000	C.111	SFX 9/24 S MC SDR	1323490000	C.109	SM 27/27 K MC SDR	1783010000	C.152
SF 3/12 MC SDR V2	1919510000	C.107	SFC 3/21 MC NE WS	1025260000	C.111	SFX 9/40 S MC NE BL	1248790000	C.109	SM 27/27 MC NE GE	1131840000	C.152
SF 3/21 MC NE BL V2	1918200000	C.107	SFC 3/21 MC SDR	1025560000	C.111	SFX 9/40 S MC NE GE	1248770000	C.109	SM 27/27 MC NE GR	1079510000	C.152
SF 3/21 MC NE GE V2	1918890000	C.107	SFC 3/30 MC NE BL	1025340000	C.111	SFX 9/40 S MC NE RT	2009920000	C.109	SM 27/27 MC NE SI	1773230000	C.152
SF 3/21 MC NE RT V2	1918900000	C.107	SFC 3/30 MC NE GE	1025320000	C.111	SFX 9/40 S MC NE WS	1248780000	C.109	SM 27/27 MC NE WS	1773220000	C.152
SF 3/21 MC NE WS V2	1918910000	C.107	SFC 3/30 MC NE RT	1025330000	C.111	SFX 9/40 S MC NE WS	1248760000	C.109	SM 27/27 MC SDR	1773240000	C.152
SF 3/21 MC SDR V2	1918880000	C.107	SFC 3/30 MC NE WS	1025310000	C.111	SFX 9/40 S MC NE WS V0	2009910000	C.109	SM 27/27 K MC NE GE	1131820000	C.150
SF 4.5/21 MC NE BL V2	1919030000	C.107	SFC 3/30 MC SDR	1025570000	C.111	SFX 9/40 S MC SDR	1248740000	C.109	SM 27/8 K MC NE GR	1079480000	C.150
SF 4.5/21 MC NE GE V2	1919000000	C.107	SFM 3/12 2.5-3.3 MM GE	2719180000	D.15	SFX-DT 10/60 S MC NE BL	2602740000	C.109	SM 27/8 K MC NE SI	1771930000	C.150
SF 4.5/21 MC NE RT V2	1919010000	C.107	SFM 3/12 2.5-3.3 MM WS	2719150000	D.15	SFX-DT 11/60 MC NE BL	2602730000	C.109	SM 27/8 K MC NE WS	1812630000	C.150
SF 4.5/21 MC NE WS V2	1919020000	C.107	SFM 3/18 2.5-3.3 MM GE	2719190000	D.15	SFX-DT 11/60 MM BL	2621480000	D.17	SM 27/8 K MC NE WS	1173690000	C.150
SF 4.5/21 MC SDR V2	1918990000	C.107	SFM 3/18 2.5-3.3 MM WS	2719160000	D.15	SFX-DT 9/24 MC NE BL	2602720000	C.109	SM 27/8 K MC NE WS	1131870000	C.150
SF 4/12 MC NE BL V2	1919590000	C.107	SFM 3/24 2.5-3.3 MM GE	2719200000	D.15	SFX-DT 9/24 MM BL	2621490000	D.17	SM 27/8 MC NE GR	1079470000	C.150
SF 4/12 MC NE GE V2	1919580000	C.107	SFM 3/24 2.5-3.3 MM WS	2719170000	D.15	SFXM 11/60 AL	1327780000	C.117	SM 27/8 MC NE SI	1713680000	C.150
SF 4/12 MC NE RT V2	1919570000	C.107	SFR 1/12 MC NE GE	1318650000	C.107	SFXM 11/60 ST	1327790000	C.117	SM 27/8 MC NE WS	1699820000	C.150
SF 4/12 MC NE WS V2	1919600000	C.107	SFR 1/12 MC NE WS	1318640000	C.107	SFXM 11/60 ST SDR	1474430000	C.117	SM 27/8 MC SDR	1699830000	C.150
SF 4/12 MC SDR V2	1919610000	C.107									

Type	Order No.	Page
SM 44/44-21 MC NE WS	1323570000	C.155
SM 44/44-21 MC SDR	1323640000	C.155
SM 45/45-24 MC NE GE	1248660000	C.155
SM 45/45-24 MC NE GR	1248670000	C.155
SM 45/45-24 MC NE WS	1248650000	C.155
SM 45/45-24 MC SDR	1248750000	C.156
SM 46/46-30 MC NE GE	1323510000	C.156
SM 46/46-30 MC NE GR	1323520000	C.156
SM 46/46-30 MC NE WS	1323500000	C.156
SM 46/46-30 MC SDR	1323610000	C.156
SM DIA 60-22 K MC NE GE	1323750000	C.156
SM DIA 60-22 MC SDR	1323740000	C.156
SM DIA 60-22 MM GE	2006060000	D.37
SM-DT 27/27 K MC NE BL	2737790000	C.152
SM-DT 27/27 MC NE BL	2737780000	C.152
SM-DT-H 27/27 BL	2737800000	C.152
SMFO 18/9.5 MM SI	2621170000	D.36
SMFO 18/9.5 MM WS	2621160000	D.36
SMFO 22/22 MM GE	2712080000	D.36
SMFO 22/22 MM SI	2712070000	D.36
SMFO 22/22 MM WS	2712060000	D.36
SMFO 27/12.5 MM GE	2621230000	D.36
SMFO 27/12.5 MM SI	2621240000	D.36
SMFO 27/12.5 MM WS	2621220000	D.36
SMFO 27/18 MM GE	2621110000	D.36
SMFO 27/18 MM SI	2621100000	D.36
SMFO 27/18 MM WS	2621100000	D.36
SMFO 27/18-22 MM GE	2621140000	D.37
SMFO 27/18-22 MM SI	2621130000	D.37
SMFO 27/18-22 MM WS	2621150000	D.37
SMFO 27/8 MM GE	2621080000	D.36
SMFO 27/8 MM SI	2621090000	D.36
SMFO 27/8 MM WS	2621070000	D.36
SMFO 36/18-30 MM GE	2621200000	D.37
SMFO 36/18-30 MM SI	2621210000	D.37
SMFO 36/18-30 MM WS	2621190000	D.37
SMFO DIA 60-22 MM GE	2621180000	D.37
SMH 27/12.5 SW	1716640000	C.151
SMH 27/18 SW	1716630000	C.151
SMH 27/27 SW	1782710000	C.152
SNAPMARK 1.5	2628200000	F.6
SNAPMARK I	1805880000	F.6
STI WATERPROOF SCHWARZ	0508401694	C.13
STI WATERPROOF SCHWARZ	0508401694	C.13
STR 5 F.SCHT 5	0294000000	E.17
STR 5 S F.SCHT 5 S	1631940000	F.7
STR 7 F.SCHT 7	0515300000	F.4
STR 7 F.SCHT 7	0515300000	F.5
STR 7 F.SCHT 7	0515300000	F.8
STR CC 15/17 TRANSPARENT	1888310000	C.159
STR CC 15/27 TRANSPARENT	1888290000	C.159
STR CC 15/49 TRANSPARENT	1888300000	C.160
STR CC 15/60 TRANSPARENT	1888280000	C.161
STR CC 30/60 TRANSPARENT	1934540000	C.162
STR F.SCHS	0139200000	F.21
SYMBOLP. 25X25X25 B/DR	1741090000	E.58
SYMBOLP. 50X50X50 B/DR	1741100000	E.58
SYMBOLP. 75X75X75 B/DR	1741110000	E.58

## T

TABPACK 14X9	1686110000	E.59
TABPACK 15X6	1686120000	E.59
TABPACK 19X11 M. RAND	1686130000	E.59
TABPACK 21X8	1686140000	E.59
TABPACK FLAG 54/8 WS	1107340000	E.59
THM EL 100 GE 30M	1419980000	D.43
THM EL 100 SI 30M	1517270000	D.43
THM EL 100 WS 30M	1420010000	D.43
THM EL 24 SI 3L 30M	1356520000	D.43
THM EL 30 GE 30M	1517190000	D.43
THM EL 30 SI 30M	1517200000	D.43
THM EL 30 WS 30M	1517180000	D.43
THM EL 50 GE 30M	1517230000	D.43
THM EL 50 SI 30M	1517240000	D.43
THM EL 50 WS 30M	1517220000	D.43
THM EL 60 SI 50M	1391400000	D.43
THM EL VIN 100 GE 30M	1463830000	D.43
THM EL VIN 100 WS 30M	2518700000	D.43
THM EL VIN 15 WS 2L 30M	1307670000	D.43
THM EL VIN 15 WS 5L 30M	1096170000	D.43
THM EL VIN 24 WS 3L 30M	1105550000	D.43
THM EL VIN 25 GE 30M	1463810000	D.43
THM EL VIN 38 WS 30M	1105560000	D.43
THM EL VIN 45 WS 30M	1474640000	D.43
THM EL VIN 50 GE 30M	1463820000	D.43
THM ESO 7 PA GE	1339580000	F.17
THM ESO 7 PA WS	1339570000	F.17
THM ET 20D5P 12.8/31 GE	1487690000	D.44
THM ET 20D5P 12.8/31 TU	1487680000	D.44
THM ET 28/28 WS	2539410000	D.18
THM ET 55/55 WS	2539380000	D.18
THM ET DIA 55 WS	2539400000	D.18
THM ET S7 1500 GE	1991670000	D.44
THM ET S7 1500 TU	1991680000	D.44
THM ET S7 1500-13 GE	2093070000	D.44
THM ET S7 1500-13 TU	2093010000	D.44
THM ET S7 300-1 GE	1161770000	D.44
THM ET S7 300-1 TU	1161750000	D.44

Type	Order No.	Page
THM ET S7 300-2 GE	1161740000	D.44
THM ET S7 300-2 TU	1161730000	D.44
THM ET S7 400 TU	1161710000	D.44
THM ET S7 50/12.5 GE	1161810000	D.44
THM ET S7 50/12.5 WS	1161790000	D.44
THM ET S7 50/25 GE	1095590000	D.44
THM ET S7 50/25 TU	1161780000	D.44
THM ET TA 58/55 WS	2539390000	D.18
THM GEW 15/6 GE	1059790000	D.43
THM GEW 15/6 WS	1059780000	D.43
THM GEW 15/9 GE	1365630000	D.43
THM GEW 17/9 GE	1059810000	D.43
THM GEW 17/9 WS	1059800000	D.43
THM GEW 18/6 GE	1059830000	D.43
THM GEW 18/6 WS	1059820000	D.43
THM GEW 18/9 GE	1059850000	D.43
THM GEW 18/9 WS	1059840000	D.43
THM GEW 20/10 GE	2712030000	D.43
THM GEW 20/10 WS	2712020000	D.43
THM GEW 20/12 GE	1391380000	D.43
THM GEW 20/8 GE	1059880000	D.43
THM GEW 20/8 WS	1059870000	D.43
THM GEW 30/8 GE	1114450000	D.43
THM GEW 38/19 GE	1335100000	D.43
THM GEW 45/23 GE	1368740000	D.43
THM MMP CASE	2457760000	D.5
THM MMP CUTTER	1331600000	D.5
THM MMP EXT.RH	1302920000	D.5
THM MMP PERFORATOR	1416330000	D.5
THM MMP ROLLER 115	1357420000	D.5
THM MMP ROLLER 115	1357420000	D.7
THM MMP ROLLER MF	2518600000	D.5
THM MMP ROLLER MF-W	2519150000	D.5
THM MMP ROLLER SFM 3	2719270000	D.5
THM MMP ROLLER SFM 3	2719270000	D.7
THM MMP ROLLER TB	2438500000	D.5
THM MT30X 100/90 SI	1058770000	D.42
THM MT30X 101/150 SI/G	1778170000	D.42
THM MT30X 101/48 GE	1751821687	D.42
THM MT30X 101/48 GE/G	1192740000	D.42
THM MT30X 101/48 SI	1751820001	D.42
THM MT30X 101/48 WS	1751821044	D.42
THM MT30X 101/74 GE	1061810000	D.42
THM MT30X 101/74 RT	1466270000	D.42
THM MT30X 101/74 SI	1762960001	D.42
THM MT30X 101/74 WS	2456620000	D.42
THM MT30X 12/6 GE	1391390000	D.41
THM MT30X 15/4 GE	1072690000	D.41
THM MT30X 15/5.1 GE	1984130000	D.41
THM MT30X 15/6 GE	1753231687	D.41
THM MT30X 15/6 SI	1753230001	D.41
THM MT30X 15/6 WS	1753231044	D.41
THM MT30X 15/9 GE	1058740000	D.41
THM MT30X 15/9 WS	1058750000	D.41
THM MT30X 16.5/5.1 GE	1516990000	D.41
THM MT30X 16/7 GE	1852520000	D.41
THM MT30X 17.5/17.5 SI	1338280000	D.41
THM MT30X 17/8 GE	1027620000	D.41
THM MT30X 17/8 WS	2712050000	D.41
THM MT30X 17/9 GE	1856650000	D.41
THM MT30X 17/9 SI	1356500000	D.41
THM MT30X 17/9 WS	1988130000	D.41
THM MT30X 18/6 GE	1753271687	D.41
THM MT30X 18/6 SI	1753270001	D.41
THM MT30X 18/6 WS	1753271044	D.41
THM MT30X 18/6.5 SI	2713810000	D.41
THM MT30X 18/9 GE	1753251687	D.41
THM MT30X 18/9 SI	1753250001	D.41
THM MT30X 18/9 WS	1753251044	D.41
THM MT30X 20/100 WS	1085440000	D.41
THM MT30X 20/8 GE	1753241687	D.41
THM MT30X 20/8 WS	1753241044	D.41
THM MT30X 24/157 SI	1317010000	D.41
THM MT30X 25.4/50.8 SI	1378120000	D.41
THM MT30X 25.9/7.1 WS	1891770000	D.41
THM MT30X 25/12 GE	1751751687	D.41
THM MT30X 25/12 SI	1751750001	D.41
THM MT30X 25/12 WS	1751751044	D.41
THM MT30X 25/17.5 SI	1770090000	D.41
THM MT30X 26/10 GE	1751761687	D.41
THM MT30X 26/10 SI	1751760001	D.41
THM MT30X 26/10 WS	1751761044	D.41
THM MT30X 27/27 SI	1477340000	D.41
THM MT30X 27/85 WS	1449830000	D.41
THM MT30X 30/20 GE	1753261687	D.41
THM MT30X 30/20 SI	1753260001	D.41
THM MT30X 30/20 WS	1753261044	D.41
THM MT30X 30/52 SI	1014680000	D.41
THM MT30X 32/9 GE	1356490000	D.41
THM MT30X 32/9 SI	1751770001	D.41
THM MT30X 32/9 WS	1751771044	D.41
THM MT30X 36/89 WS	1180910000	D.41
THM MT30X 38.1/31.8 SI	1862350000	D.41
THM MT30X 38/17 WS	1011610000	D.41
THM MT30X 38/19 GE	1751801687	D.41
THM MT30X 38/19 SI	1751800001	D.41
THM MT30X 38/19 WS	1751801044	D.41
THM MT30X 45/23 GE	1751811687	D.41
THM MT30X 45/23 SI	1751810001	D.41

Type	Order No.	Page
THM MT30X 45/23 WS	1751811044	D.41
THM MT30X 50/18 WS	2621550000	D.41
THM MT30X 57/27 SI	1852540000	D.41
THM MT30X 63.5/50.8 SI	1378110000	D.42
THM MT30X 65/35 GE	1751831687	D.42
THM MT30X 65/35 RT	1538740000	D.42
THM MT30X 65/35 SI	1751830001	D.42
THM MT30X 65/35 SI/G	1751830004	D.42
THM MT30X 65/35 WS	1751831044	D.42
THM MT30X 76.2/50.8 WS	1378130000	D.42
THM MT30X 76/25 WS	1498790000	D.42
THM MT30X 8/8 GE	1310540000	D.41
THM MT30X 8/8 WS	1954070000	D.41
THM MT30X 89/60 SI	1003410000	D.42
THM MT30X 89/60 WS	1498780000	D.42
THM MT30X DIA 30 GE	2712040000	D.42
THM MULTIMARK	2599430000	D.5
THM MULTIMARK PLUS	2599440000	D.7
THM PLUS M PERFORATOR	1540770000	D.7
THM VIN 101/150 GE/G	1192760000	D.42
THM VIN 101/74 GE/G	1192750000	D.42
THM VIN 36/18 SI	1209010000	D.42
THM WO 12/18 GE	1856630000	D.21
THM WO 12/18 WS	1856640000	D.21
THM WO 14/22 WS	2621530000	D.21
THM WO 15/140 WS	1429450000	D.21
THM WO 15/70 WS	1429440000	D.21
THM WO 17.8/34 WS	1774380000	D.21
THM WO 20/32 WS	2621500000	D.21
THM WO 24.5/100 WS	2004970000	D.21
THM WO 24.5/62 WS	1109130000	D.21
THM WO 24/69 WS	2621520000	D.21
THM WO 25.4/93 WS	2711990000	D.21
THM WO 25.4/95.2 WS	1109140000	D.21
THM WO 25/140 GE	1751561687	D.21
THM WO 25/140 WS	1751561044	D.21
THM WO 25/37 WS	2621510000	D.21
THM WO 25/76 GE	1774340000	D.21
THM WO 25/76 WS	1774350000	D.21
THM WO 33.5/93.1 GE	1774410000	D.21
THM WO 33.5/93.1 WS	1774400000	D.21
THM WO 50.8/150 BL	1109190000	D.21
THM WO 50.8/150 GE	1109180000	D.21
THM WO 50.8/150 RT	1109170000	D.21
THM WO 50.8/150 WS	1109150000	D.21
THM WO 51/36 WS	1934190000	D.21
THM WO T 24.5/100 WS	1003380000	D.21
THM WO T 24.5/62 WS	1003420000	D.21
THM WO VIN 12.7/19 WS	2657100000	D.22
THM WO VIN 12.7/38.1 WS	2657110000	D.22
THM WO VIN 12/18 WS	1382940000	D.22
THM WO VIN 17.8/34 WS	1382930000	D.22
THM WO VIN 24.5/100 WS	1391430000	D.22
THM WO VIN 24.5/62 WS	1391410000	D.22
THM WO VIN 25.4/19 SP WS	2657130000	D.22
THM WO VIN 25.4/19 WS	2657120000	D.22
THM WO VIN 25.4/31.8 SP WS	2657150000	D.22
THM WO VIN 25.4/31.8 WS	2657140000	D.22
THM WO VIN 25.4/36.5 GE IW	2625560000	D.22
THM WO VIN 25.4/36.5 WS IW	1110600000	D.22
THM WO VIN 25.4/38.1 SP WS	2657170000	D.22
THM WO VIN 25.4/38.1 WS	2657160000	D.22
THM WO VIN 25.4/57.2 SP WS	2657190000	D.22
THM WO VIN 25.4/57.2 WS	2657180000	D.22
THM WO VIN 25.4/63.5 SP WS	2657210000	D.22
THM WO VIN 25.4/63.5 WS	2657200000	D.22
THM WO VIN 25.4/95.2 WS IW	1110610000	D.22
THM WO VIN 25/25 WS	1253150000	D.22
THM WO VIN 49.5/57.1 WS	1882900000	D.22
THM WO-Q 25/19.1 WS	2711870000	D.21
THM WO-Q 25/31.8 WS	2711880000	D.21
THM WO-Q 25/38.1 WS	2711890000	D.21
THM WO-Q 25/51.4 WS	2711900000	D.21

Type	Order No.	Page
TMH 18 MM WS	2005470000	F.14
TMH 20 MC NE BL	1680411693	C.113
TMH 20 MC NE GE	1680411687	C.113
TMH 20 MC NE RT	1680411686	C.113
TMH 20 MC NE WS	1680411044	C.113
TMH 20 MC NE WS	1680411044	F.12
TMH 20 MC NE WS	1680411044	F.14
TMH 20 MC SDR	1680420000	C.113
TMH 20 MM BL	2005950000	D.16
TMH 20 MM GE	2005640000	D.16
TMH 20 MM RT	2005820000	D.16
TMH 20 MM WS	2005490000	D.16
TMH 20 MM WS	2005490000	F.12
TMH 20 MM WS	2005490000	F.14
TMH 23 MC NE BL	1428520000	C.113
TMH 23 MC NE GE	1428490000	C.113
TMH 23 MC NE RT	1428510000	C.113
TMH 23 MC NE WS	1428480000	C.113
TMH 23 MC NE WS	1428480000	F.14
TMH 23 MC SDR	1433830000	C.113
TMH 23 MM BL	2005970000	D.16
TMH 23 MM GE	2005670000	D.16
TMH 23 MM RT	2005850000	D.16
TMH 23 MM WS	2005510000	D.16
TMH 23 MM WS	2005510000	F.14
TMH 30 MC NE BL	1876400000	C.113
TMH 30 MC NE GE	1876370000	C.113
TMH 30 MC NE RT	1876380000	C.113
TMH 30 MC NE WS	1876390000	C.113
TMH 30 MC NE WS	1876390000	F.12
TMH 30 MC NE WS	1876390000	F.14
TMH 30 MC SDR	1876320000	C.113
TMH 30 MM BL	2005990000	D.16
TMH 30 MM GE	2005700000	D.16
TMH 30 MM RT	2005870000	D.16
TMH 30 MM WS	2005630000	D.16
TMH 30 MM WS	2005630000	F.12
TMH 30 MM WS	2005630000	F.14
TMX 18 HF/HB	1748820000	F.11
TMX 30 VO	1866680000	F.13

## V

VT SFX 10/23 MC NE GE VO	1727770004	C.109
VT SFX 10/23 MC NE WS VO	1727770001	C.109
VT SFX 14/23 MC NE GE VO	1689490004	C.109
VT SFX 14/23 MC NE WS VO	1689490001	C.109
VT SFX 9/24 MC NE GE VO	1727740004	C.109
VT SFX 9/24 MC NE WS VO	1727740001	C.109

## W

WAD 12 MC B GE/SW	2445090000	C.97
WAD 12 MC NE GE	2445080000	C.97
WAD 12 MC NE WS	2445070000	C.97
WAD 12 MC SDR	2445100000	C.97
WAD 27 M. BL	1062860000	F.3
WAD 27 NEUTRAL	1062960000	F.3
WAD 5 MC B GE/SW	1120450000	C.95
WAD 5 MC NE GE	1112920000	C.95
WAD 5 MC NE WS	1112910000	C.95
WAD 5 MC SDR	1112930000	C.95
WAD 8 MC B GE/SW	1120470000	C.96
WAD 8 MC NE GE	1112950000	C.96
WAD 8 MC NE WS	1112940000	C.96
WAD 8 MC SDR	1112970000	C.96
WKM 18/43	1610700000	C.100
WKM 18/43	1610700000	C.115
WKM 18/43	1610700000	F.18
WKM 8/20	1753490000	F.17
WKM 8/30	1631910000	C.115
WKM 8/30	1631910000	C.99
WKM 8/30	1631910000	F.17
WM 0/12 1.0-2.0 MM GE	2006250000	D.15
WM 0/12 1.0-2.0 MM WS	2006170000	D.15
WM 0/21 1.0-2.0 MM GE	2006090000	D.15
WM 0/21 1.0-2.0 MM WS	2006010000	D.15
WM 0/6 1.0-2.0 MM GE	2006410000	D.15
WM 0/6 1.0-2.0 MM WS	2006330000	D.15
WM 1/12 2.0-3.5 MM GE	2006270000	D.15
WM 1/12 2.0-3.5 MM WS	2006190000	D.15
WM 1/21 2.0-3.5 MM GE	2006110000	D.15
WM 1/21 2.0-3.5 MM WS	2006030000	D.15
WM 1/6 2.0-3.5 MM GE	2006430000	D.15
WM 1/6 2.0-3.5 MM WS	2006350000	D.15
WM 2/12 3.5-5.0 MM GE	2006290000	D.15
WM 2/12 3.5-5.0 MM WS	2006210000	D.15
WM 2/21 3.5-5.0 MM GE	2006130000	D.15
WM 2/21 3.5-5.0 MM WS	2006050000	D.15
WM 2/6 3.5-5.0 MM GE	2006450000	D.15
WM 2/6 3.5-5.0 MM WS	2006370000	D.15
WM 3/12 5.0-8.0 MM GE	2006310000	D.15
WM 3/12 5.0-8.0 MM WS	2006230000	D.15
WM 3/21 5.0-8.0 MM GE	2006150000	D.15
WM 3/21 5.0-8.0 MM WS	2006070000	D.15
WM 3/6 5.0-8.0 MM GE	2006470000	D.15
WM 3/6 5.0-8.0 MM WS	2006390000	D.15
WS 10/12 MC NE WS	1905970000	C.46
WS 10/12 MC SDR	1906060000	C.46

Type	Order No.	Page
WS 10/15 MC NE WS	1854090000	C.47
WS 10/15 MC SDR	1854100000	C.47
WS 10/3.5 PLUS MC NE WS	2003760000	C.35
WS 10/3.5 PLUS MC SDR	2007760000	C.35
WS 10/5 M MC NE WS	1792000000	C.38
WS 10/5 M MC NE WS	1792000000	F.6
WS 10/5 M MC NE WS	1792000000	F.8
WS 10/5 M PLUS MC NE WS	2003770000	C.38
WS 10/5 M PLUS MC SDR	2007770000	C.38
WS 10/5 MC M SDR	1792010000	C.38
WS 10/5 MC NE BL	1773531693	C.37
WS 10/5 MC NE GE	1773531687	C.37
WS 10/5 MC NE RT	1773531686	C.37
WS 10/5 MC NE WS	1635000000	C.37
WS 10/5 MC SDR	1635010000	C.37
WS 10/5 MM WS	2712130000	D.11
WS 10/5 MM WS	2712130000	F.6
WS 10/5 MM WS	2712130000	F.8
WS 10/5 PLUS MC NE WS	1046380000	C.37
WS 10/5 PLUS MC SDR	1046320000	C.37
WS 10/6 M MC NE WS	1818400000	C.42
WS 10/6 M PLUS MC NE WS	2003780000	C.43
WS 10/6 M PLUS MC SDR	2007780000	C.43
WS 10/6 MC M NE BL	1069080000	C.42
WS 10/6 MC M NE GE	1917430000	C.42
WS 10/6 MC M NE GN	1917420000	C.42
WS 10/6 MC M NE RT	1917440000	C.42
WS 10/6 MC M NE VI	1069090000	C.42
WS 10/6 MC M SDR	1818410000	C.42
WS 10/6 MC NE WS	1828450000	C.41
WS 10/6 MC SDR	1828460000	C.41
WS 10/6 MM WS	2712140000	D.11
WS 10/6 PLUS MC NE WS	1046390000	C.42
WS 10/6 PLUS MC SDR	1046330000	C.42
WS 10/8 PLUS MC NE WS	1905950000	C.45
WS 10/8 PLUS MC SDR	1906030000	C.45
WS 12/3.5 MC NE WS	1778270000	C.35
WS 12/3.5 MC SDR	1778280000	C.35
WS 12/3.5 MM BP WS	2619840000	D.11
WS 12/3.5 MM BP WS	2619840000	F.6
WS 12/3.5 MM WS	2007180000	D.11
WS 12/3.5 MM WS	2007180000	F.6
WS 12/5 MC NE BL	1773541693	C.39
WS 12/5 MC NE GE	1773541687	C.39
WS 12/5 MC NE OR	1773541690	C.39
WS 12/5 MC NE RT	1773541686	C.39
WS 12/5 MC NE WS	1609860000	C.39
WS 12/5 MC NE WS	1609860000	F.4
WS 12/5 MC NE WS	1609860000	F.5
WS 12/5 MC SDR	1609870000	C.39
WS 12/5 MM BP WS	2619850000	D.11
WS 12/5 MM WS	2007190000	D.11
WS 12/5 MM WS	2007190000	F.5
WS 12/5 PLUS MC NE WS	1927510000	C.39
WS 12/5 PLUS MC SDR	1927520000	C.39
WS 12/6 MC NE BL	1773551693	C.43
WS 12/6 MC NE BR	1773551692	C.43
WS 12/6 MC NE GE	1773551687	C.43
WS 12/6 MC NE OR	1773551690	C.43
WS 12/6 MC NE RT	1773551686	C.43
WS 12/6 MC NE WS	1773551689	C.43
WS 12/6 MC NE WS	1609800000	C.43
WS 12/6 MC SDR	1609910000	C.43
WS 12/6 MM BP WS	2619860000	D.11
WS 12/6 MM WS	2007200000	D.11
WS 12/6 PLUS MC NE WS	1927530000	C.44
WS 12/6 PLUS MC SDR	1927540000	C.44
WS 12/6.5 MC NE BL	1773561693	C.44
WS 12/6.5 MC NE GE	1773561687	C.44
WS 12/6.5 MC NE RT	1773561686	C.44
WS 12/6.5 MC NE WS	1609920000	C.44
WS 12/6.5 MC SDR	1609930000	C.44
WS 12/6.5 MM WS	2619930000	D.11
WS 12/8 MM BP WS	2619870000	D.11
WS 12/8 MM WS	2007210000	D.11
WS 12/8 PLUS MC NE WS	1906000000	C.45
WS 12/8 PLUS MC SDR	1906010000	C.45
WS 14/5 MC NE WS	1768090000	C.40
WS 14/5 MC SDR	1852980000	C.40
WS 15/5 MC NE GE	1773571687	C.40
WS 15/5 MC NE WS	1609880000	C.40
WS 15/5 MC SDR	1609890000	C.40
WS 7.8/9.2 PLUS MC NE GR	1208970000	C.46
WS 7.8/9.2 PLUS MC SDR	1270640000	C.46
WS 8/3.5 MM BP WS	2619800000	D.11
WS 8/3.5 MM WS	2007140000	D.11
WS 8/5 MC NE BL	1773521693	C.36
WS 8/5 MC NE GE	1773521687	C.36
WS 8/5 MC NE RT	1773521690	C.36
WS 8/5 MC NE WS	1773521686	C.36
WS 8/5 MC NE WS	1640740000	C.36
WS 8/5 MC NE WS	1640740000	F.22
WS 8/5 MC SDR	1640750000	C.36
WS 8/5 MM BP WS	2619810000	D.11
WS 8/5 MM WS	2007150000	D.11
WS 8/5 MM WS	2007150000	F.22
WS 8/5 PLUS MC NE WS	1951870000	C.36
WS 8/5 PLUS MC SDR	1038790000	C.36
WS 8/6 MM BP WS	2619820000	D.11

Type	Order No.	Page
WS 8/6 MM WS	2007160000	D.11
WS 8/6 PLUS MC NE WS	1951880000	C.41
WS 8/6 PLUS MC SDR	1038820000	C.41
WS 8/8 MM BP WS	2619830000	D.11
WS 8/8 MM WS	2007170000	D.11
WS-A 12/8 MM WS	2448920000	D.11
WS-A 8/10 MM WS	2619890000	D.11
WS-A 8/12 MM WS	2619900000	D.11
WS-A 8/16 MM WS	2619910000	D.11
WS-A 8/8 MM WS	2448930000	D.11
WSK 12_LEER	0335900000	E.52
WSK 12.M.CLI.3 GE/SW BEZ.09/+/-	0336000000	E.52
WSM 10 -	1712501740	E.55
WSM 10 (	1712501744	E.55
WSM 10 .	1712501743	E.55
WSM 10 /	1712501739	E.55
WSM 10 -	1712501741	E.55
WSM 10 ~	1712501056	E.55
WSM 10 +	1712501738	E.55
WSM 10 -	1712501742	E.55
WSM 10 0	1712501000	E.55
WSM 10 1	1712500001	E.55
WSM 10 2	1712500002	E.55
WSM 10 3	1712500003	E.55
WSM 10 4	1712500004	E.55
WSM 10 5	1712500005	E.55
WSM 10 6	1712500006	E.55
WSM 10 7	1712500007	E.55
WSM 10 8	1712500008	E.55
WSM 10 9	1712500009	E.55
WSM 10 A	1712501637	E.55
WSM 10 A	1712501054	E.55
WSM 10 A	1712501700	E.55
WSM 10 A	1712501672	E.55
WSM 10 B	1712501639	E.55
WSM 10 C	1712501641	E.55
WSM 10 D	1712501643	E.55
WSM 10 E	1712501645	E.55
WSM 10 ERDE	1712501053	E.55
WSM 10 F	1712501647	E.55
WSM 10 G	1712501649	E.55
WSM 10 H	1712501651	E.55
WSM 10 I	1712501653	E.55
WSM 10 J	1712501655	E.55
WSM 10 K	1712501657	E.55
WSM 10 L	1712501659	E.55
WSM 10 M	1712501661	E.55
WSM 10 N	1712501663	E.55
WSM 10 O	1712501665	E.55
WSM 10 0	1712501055	E.55
WSM 10 Ø	1712501670	E.55
WSM 10 P	1712501667	E.55
WSM 10 Q	1712501669	E.55
WSM 10 R	1712501671	E.55
WSM 10 S	1712501673	E.55
WSM 10 T	1712501676	E.55
WSM 10 U	1712501679	E.55
WSM 10 V	1712501699	E.55
WSM 10 V	1712501681	E.55
WSM 10 W	1712501683	E.55
WSM 10 X	1712501687	E.55
WSM 10 Y	1712501696	E.55
WSM 10 Z	1712501698	E.55
WSM SERVICE BOX KOMP.	1924930000	E.55
WSM TOOL AUTOMATIK	1774470000	G.33
WSM TOOL MANUELL	1774480000	G.33
WSMC 11-15	1891670000	E.56
WSMC 1-5	1912170000	E.56
WSMC 16-20	1912140000	E.56
WSMC 21-25	1912150000	E.56
WSMC 26-30	1912160000	E.56
WSMC 6-10	1891680000	E.56
WSMH 108MM	1774530000	E.56
WSMH 176MM	1002680000	E.56
WSMH 288MM	1774490000	E.56
WSMH 48MM	1774500000	E.56
WSMH 60MM	1774510000	E.56
WSMH 84MM	1774520000	E.56

## Z

ZGB 15	1636530000	F.4
ZGB 30	1611930000	F.5
ZS 10/5 MC NE WS	1610000000	C.51
ZS 10/5 MC SDR	1610010000	C.51
ZS 12/6 MC NE WS	1610020000	C.52
ZS 12/6 MC SDR	1610030000	C.52
ZS 15/5 MC NE WS	1646630000	C.51
ZS 15/5 MC SDR	1646640000	C.51
ZS 30/5 MC NE WS	2681880000	C.52
ZS 30/5 MC SDR	2682070000	C.52

Order No.	Type	Page
<b>013000000</b>		
0133360001	DEK 6 FSZ 1-10	E.3
0133360011	DEK 6 FSZ 11-20	E.3
0133360021	DEK 6 FSZ 21-30	E.3
0133360031	DEK 6 FSZ 31-40	E.3
0133360041	DEK 6 FSZ 41-50	E.3
0139800000	SCHS1	F.21
0139000000	ESO/SCHS1 500X12,5X0,3	F.21
0139200000	STR F.SCHS	F.21

## 017000000

0171111687	CLJ C 1-3 GE NE MP	E.7
0171301687	CLJ C 2-4 GE NE CD	E.8

## 018000000

0189400000	CLJ MH 110 HSTR	E.51
------------	-----------------	------

## 021000000

0213811687	CLJ C 02-3 GE NE MP	E.7
------------	---------------------	-----

## 023000000

0235860000	DEK 5 FWZ 1,3,5-19	E.3
0235960000	DEK 5 FWZ 21,23,25-39	E.3
0236060000	DEK 5 FWZ 41,43,45-59	E.3
0236160000	DEK 5 FWZ 2,4,6-20	E.3
0236260000	DEK 5 FWZ 22,24,26-40	E.3
0236360000	DEK 5 FWZ 42,44,46-60	E.3

## 025000000

0251310001	CLJ C 2-4 WS/SW 1 MP	E.26
0251310002	CLJ C 2-4 WS/SW 2 MP	E.26
0251310003	CLJ C 2-4 WS/SW 3 MP	E.26
0251310004	CLJ C 2-4 WS/SW 4 MP	E.26
0251310005	CLJ C 2-4 WS/SW 5 MP	E.26
0251310006	CLJ C 2-4 WS/SW 6 MP	E.26
0251310007	CLJ C 2-4 WS/SW 7 MP	E.26
0251310008	CLJ C 2-4 WS/SW 8 MP	E.26
0251310009	CLJ C 2-4 WS/SW 9 MP	E.25
0251310010	CLJ C 2-4 WS/SW 10 MP	E.26
0251310011	CLJ C 2-4 WS/SW + MP	E.27
0251311049	CLJ C 2-4 WS/SW -MP	E.27
0251311502	CLJ C 2-4 GE/SW 0 MP	E.26
0251311503	CLJ C 2-4 SW/WS 0 MP	E.25
0251311505	CLJ C 2-4 GE/SW 1 MP	E.26
0251311506	CLJ C 2-4 BR/WS 1 MP	E.25
0251311508	CLJ C 2-4 GE/SW 2 MP	E.26
0251311509	CLJ C 2-4 RT/WS 2 MP	E.25
0251311511	CLJ C 2-4 GE/SW 3 MP	E.26
0251311512	CLJ C 2-4 OR/SW 3 MP	E.25
0251311514	CLJ C 2-4 GE/SW 4 MP	E.26
0251311514	CLJ C 2-4 GE/SW 4 MP	E.26
0251311517	CLJ C 2-4 GE/SW 5 MP	E.26
0251311518	CLJ C 2-4 GN/WS 5 MP	E.25
0251311520	CLJ C 2-4 GE/SW 6 MP	E.26
0251311520	CLJ C 2-4 BL/WS 6 MP	E.25
0251311523	CLJ C 2-4 GE/SW 7 MP	E.26
0251311524	CLJ C 2-4 V/WS 7 MP	E.25
0251311526	CLJ C 2-4 GE/SW 8 MP	E.26
0251311527	CLJ C 2-4 GR/SW 8 MP	E.25
0251311529	CLJ C 2-4 GE/SW 9 MP	E.26
0251311637	CLJ C 2-4 GE/SW A MP	E.26
0251311639	CLJ C 2-4 GE/SW B MP	E.26
0251311641	CLJ C 2-4 GE/SW C MP	E.26
0251311643	CLJ C 2-4 GE/SW D MP	E.26
0251311645	CLJ C 2-4 GE/SW E MP	E.26
0251311647	CLJ C 2-4 GE/SW F MP	E.26
0251311649	CLJ C 2-4 GE/SW G MP	E.26
0251311651	CLJ C 2-4 GE/SW H MP	E.26
0251311653	CLJ C 2-4 GE/SW I MP	E.26
0251311655	CLJ C 2-4 GE/SW J MP	E.26
0251311657	CLJ C 2-4 GE/SW K MP	E.26
0251311659	CLJ C 2-4 GE/SW L MP	E.26
0251311661	CLJ C 2-4 GE/SW M MP	E.26
0251311663	CLJ C 2-4 GE/SW N MP	E.26
0251311665	CLJ C 2-4 GE/SW O MP	E.26
0251311667	CLJ C 2-4 GE/SW P MP	E.26
0251311669	CLJ C 2-4 GE/SW Q MP	E.26
0251311671	CLJ C 2-4 GE/SW R MP	E.26
0251311673	CLJ C 2-4 GE/SW S MP	E.26
0251311676	CLJ C 2-4 GE/SW T MP	E.26
0251311679	CLJ C 2-4 GE/SW U MP	E.26
0251311681	CLJ C 2-4 GE/SW V MP	E.26
0251311683	CLJ C 2-4 GE/SW W MP	E.26
0251311687	CLJ C 2-4 GE/SW X MP	E.26
0251311695	CLJ C 2-4 GE/SW 0 MP	E.27
0251311696	CLJ C 2-4 GE/SW Y MP	E.27
0251311697	CLJ C 2-4 GE/SW Z MP	E.27
0251311698	CLJ C 2-4 GE/SW A MP	E.26
0251311699	CLJ C 2-4 GE/SW B MP	E.26
0251311700	CLJ C 2-4 GE/SW C MP	E.26
0251311701	CLJ C 2-4 GE/SW D MP	E.26
0251311702	CLJ C 2-4 GE/SW E MP	E.26
0251311703	CLJ C 2-4 GE/SW F MP	E.26
0251311704	CLJ C 2-4 GE/SW G MP	E.26
0251311705	CLJ C 2-4 GE/SW H MP	E.26
0251311706	CLJ C 2-4 GE/SW I MP	E.26
0251311707	CLJ C 2-4 GE/SW J MP	E.26
0251311708	CLJ C 2-4 GE/SW K MP	E.26
0251311709	CLJ C 2-4 GE/SW L MP	E.26
0251311710	CLJ C 2-4 GE/SW M MP	E.26
0251311711	CLJ C 2-4 GE/SW N MP	E.26
0251311712	CLJ C 2-4 GE/SW O MP	E.26
0251311713	CLJ C 2-4 GE/SW P MP	E.26
0251311714	CLJ C 2-4 GE/SW Q MP	E.26
0251311715	CLJ C 2-4 GE/SW R MP	E.26
0251311716	CLJ C 2-4 GE/SW S MP	E.26
0251311717	CLJ C 2-4 GE/SW T MP	E.26
0251311718	CLJ C 2-4 GE/SW U MP	E.26
0251311719	CLJ C 2-4 GE/SW V MP	E.26
0251311720	CLJ C 2-4 GE/SW W MP	E.26
0251311721	CLJ C 2-4 GE/SW X MP	E.26
0251311722	CLJ C 2-4 GE/SW Y MP	E.26
0251311723	CLJ C 2-4 GE/SW Z MP	E.26
0251311724	CLJ C 2-4 GE/SW A MP	E.26
0251311725	CLJ C 2-4 GE/SW B MP	E.26
0251311726	CLJ C 2-4 GE/SW C MP	E.26
0251311727	CLJ C 2-4 GE/SW D MP	E.26
0251311728	CLJ C 2-4 GE/SW E MP	E.26
0251311729	CLJ C 2-4 GE/SW F MP	E.26
0251311730	CLJ C 2-4 GE/SW G MP	E.26
0251311731	CLJ C 2-4 GE/SW H MP	E.26
0251311732	CLJ C 2-4 GE/SW I MP	E.26
0251311733	CLJ C 2-4 GE/SW J MP	E.26
0251311734	CLJ C 2-4 GE/SW K MP	E.26
0251311735	CLJ C 2-4 GE/SW L MP	E.26
0251311736	CLJ C 2-4 GE/SW M MP	E.26
0251311737	CLJ C 2-4 GE/SW N MP	E.26
0251311738	CLJ C 2-4 GE/SW O MP	E.26

Order No.	Type	Page
0251311740	CLJ C 2-4 GE/SW -MP	E.27
0251311742	CLJ C 2-4 GE/SW /MP	E.27
0251311746	CLJ C 2-4 GE/SW ET MP	E.27
0251311747	CLJ C 2-4 GE/SW PET. MP	E.27
0251311748	CLJ C 2-4 GE/SW .MP	E.27
0251311750	CLJ C 2-4 GE/SW :MP	E.27
0251311751	CLJ C 2-4 GE/SW - MP	E.27
0251311752	CLJ C 2-4 GE/SW AC MP	E.27
0251111503	CLJ C 02-3 WS/WS 0 MP	E.11
0252111506	CLJ C 02-3 BR/WS 1 MP	E.11
0252111509	CLJ C 02-3 RT/WS 2 MP	E.11
0252111512	CLJ C 02-3 OR/SW 3 MP	E.11
0252111514	CLJ C 02-3 GE/SW 4 MP	E.11
0252111518	CLJ C 02-3 GN/WS 5 MP	E.11
0252111521	CLJ C 02-3 BL/WS 6 MP	E.11
0252111524	CLJ C 02-3 V/WS 7 MP	E.11
0252111527	CLJ C 02-3 GR/SW 8 MP	E.11
0252111530	CLJ C 02-3 WS/SW 9 MP	E.11
0252111637	CLJ C 02-3 GE/SW A MP	E.12
0252111639	CLJ C 02-3 GE/SW B MP	E.12
0252111641	CLJ C 02-3 GE/SW C MP	E.12
0252111643	CLJ C 02-3 GE/SW D MP	E.12
0252111645	CLJ C 02-3 GE/SW E MP	E.12
0252111647	CLJ C 02-3 GE/SW F MP	E.12
0252111649	CLJ C 02-3 GE/SW G MP	E.12
0252111651	CLJ C 02-3 GE/SW H MP	E.12
0252111653	CLJ C 02-3 GE/SW I MP	E.12
0252111655	CLJ C 02-3 GE/SW J MP	E.12
0252111657	CLJ C 02-3 GE/SW K MP	E.12
0252111659	CLJ C 02-3 GE/SW L MP	E.12
0252111661	CLJ C 02-3 GE/SW M MP	E.12
0252111663	CLJ C 02-3 GE/SW N MP	E.12
0252111665	CLJ C 02-3 GE/SW O MP	E.12
0252111667	CLJ C 02-3 GE/SW P MP	E.12
0252111669	CLJ C 02-3 GE/SW Q MP	E.12
0252111671	CLJ C 02-3 GE/SW R MP	E.12
0252111673	CLJ C 02-3 GE/SW S MP	E.12
0252111676	CLJ C 02-3 GE/SW T MP	E.12
0252111679	CLJ C 02-3 GE/SW U MP	E.12
0252111681	CLJ C 02-3 GE/SW V MP	E.12
0252111683	CLJ C 02-3 GE/SW W MP	E.12
0252111687	CLJ C 02-3 GE/SW X MP	E.12
0252111695	CLJ C 02-3 GE/SW 0 MP	E.12
0252111696	CLJ C 02-3 GE/SW Y MP	E.12
0252111697	CLJ C 02-3 GE/SW A MP	E.12
0252111698	CLJ C 02-3 GE/SW B MP	E.12
0252111699	CLJ C 02-3 GE/SW C MP	E.12
0252111726	CLJ C 02-6 GE/SW A1 MP	E.15
0252111727	CLJ C 02-6 GE/SW A2 MP	E.15
0252111728	CLJ C 02-6 GE/SW A1 MP	E.15
0252111729	CLJ C 02-6 GE/SW L2 MP	E.15
0252111730	CLJ C 02-6 GE/SW L3 MP	E.15
0252111734	CLJ C 02-9 GE/SW PEN MP	E.15
0252111737	CLJ C 02-3 RT/WS + MP	E.12
0252111738	CLJ C 02-3 GE/SW + MP	E.12
0252111740	CLJ C 02-3 GE/SW - MP	E.12
0252111741	CLJ C 02-3 BL/WS - MP	E.12
0252111742	CLJ C 02-3 GE/SW /MP	E.12
0252111746	CLJ C 02-3 GE/SW ET MP	E.12
0252111748	CLJ C 02-3 GE/SW .MP	E.12
0252111750	CLJ C 02-3 GE/SW :MP	E.12
0252111751	CLJ C 02-3 GE/SW - MP	E.12
0252111752	CLJ C 02-3 GE/SW AC MP	E.12
0252509999	CLJ C 02-15 SDR SG	E.9
0252611502	CLJ C 1-3 GE/SW 0 MP	E.16
0252611503	CLJ C 1-3 WS/WS 0 MP	E.16
0252611505	CLJ C 1-3 GE/SW 1 MP	E.16
0252611506	CLJ C 1-3 BR/WS 1 MP	E.16
0252611508	CLJ C 1-3 GE/SW 2 MP	E.16
0252611509	CLJ C 1-3 RT/WS 2 MP	E.16
0252611511	CLJ C 1-3 GE/SW 3 MP	E.16
0252611512	CLJ C 1-3 OR/SW 3 MP	E.16
0252611514	CLJ C 1-3 GE/SW 4 MP	E.16
0252611517	CLJ C 1-3 GE/SW 5 MP	E.16
0252611518	CLJ C 1-3 GN/WS 5 MP	E.16
0252611520	CLJ C 1-3 GE/SW 6 MP	E.16
0252611521	CLJ C 1-3 BL/WS 6 MP	E.16
0252611523	CLJ C 1-3 GE/SW 7 MP	E.16
0252611524	CLJ C 1-3 V/WS 7 MP	E.16
0252611526	CLJ C 1-3 GE/SW 8 MP	E.16
0252611527	CLJ C 1-3 GR/SW 8 MP	E.16
0252611529	CLJ C 1-3 GE/SW 9 MP	E.16
0252611530	CLJ C 1-3 WS/WS 9 MP	E.16
0252611637	CLJ C 1-3 GE/SW A MP	E.17
0252611639	CLJ C 1-3 GE/SW B MP	E.17
0252611641	CLJ C 1-3 GE/SW C MP	E.17
0252611643	CLJ C 1-3 GE/SW D MP	E.17
0252611645	CLJ C 1-3 GE/SW E MP	E.17
0252611647	CLJ C 1-3 GE/SW F MP	E.17
0252611649	CLJ C 1-3 GE/SW G MP	E.17
0252611651	CLJ C 1-3 GE/SW H MP	E.17
0252611653	CLJ C 1-3 GE/SW I MP	E.17
0252611655	CLJ C 1-3 GE/SW J MP	E.17
0252611657	CLJ C 1-3 GE/SW K MP	E.17
0252611659	CLJ C 1-3 GE/SW L MP	E.17
0252611661	CLJ C 1-3 GE/SW M MP	E.17
0252611663	CLJ C 1-3 GE/SW N MP	E.17
0252611664	CLJ C 1-3 BL/WS N MP	E.17
0252611665	CLJ C 1-3 GE/SW O MP	E.17

Order No.	Type	Page
0252611667	CLJ C 1-3 GE/SW P MP	E.17
0252611669	CLJ C 1-3 GE/SW Q MP	E.17
0252611671	CLJ C 1-3 GE/SW R MP	E.17
0252611673	CLJ C 1-3 GE/SW S MP	E.17
0252611676	CLJ C 1-3 GE/SW T MP	E.17
0252611679	CLJ C 1-3 GE/SW U MP	E.17
0252611681	CLJ C 1-3 GE/SW V MP	E.17
0252611683	CLJ C 1-3 GE/SW W MP	E.17
0252611687	CLJ C 1-3 GE/SW X MP	E.17
0252611695	CLJ C 1-3 GE/SW 0 MP	E.17
0252611696	CLJ C 1-3 GE/SW Y MP	E.17
0252611697	CLJ C 1-3 GE/SW A MP	E.17
0252611698	CLJ C 1-3 GE/SW Z MP	E.17
0252611699	CLJ C 1-3 GE/SW A MP	E.17
0252611737	CLJ C 1-3 RT/WS + MP	E.17
0252611738	CLJ C 1-3 GE/SW + MP	E.17
0252611740	CLJ C 1-3 GE/SW - MP	E.17
0252611741	CLJ C 1-3 BL/WS - MP	E.17
0252611742	CLJ C 1-3 GE/SW /MP	E.17
0252611746	CLJ C 1-3 GE/SW ET MP	E.17
0252611747	CLJ C 1-3 GE/SW .MP	E.17
0252611748	CLJ C 1-3 GE/SW :MP	E.17
0252611750	CLJ C 1-3 GE/SW - MP	E.17
0252611751	CLJ C 1-3 GE/SW AC MP	E.17
0252611752	CLJ C 1-3 GE/SW AC MP	E.17
0252709999	CLJ C 1-6 SDR CD	E.9
0252711522	CLJ C 1-6 GE/SW 01 MP	E.21
0252711523	CLJ C 1-6 GE/SW 02 MP	E.21
0252711524	CLJ C 1-6 GE/SW 03 MP	E.21
0252711525	CLJ C 1-6 GE/SW 04 MP	E.21
0252711526	CLJ C 1-6 GE/SW 05 MP	E.21
0252711527	CLJ C 1-6 GE/SW 06 MP	E.21
0252711528	CLJ C 1-6 GE/SW 07 MP	E.21
0252711529	CLJ C 1-6 GE/SW 08 MP	E.21
0252711530	CLJ C 1-6 GE/SW 09 MP	E.21
0252711531	CLJ C 1-6 GE/SW 10 MP	E.21
0252711532	CLJ C 1-6 GE/SW 11 MP	E.21
0252711533	CLJ C 1-	

Order No.	Type	Page
-----------	------	------

## 0330000000

0335900000	WSK 12 , LEER	E.52
0336000000	WSK 12 M. CLI C 1-3 GE/SW BEZ.D.9/+/-	E.52
0337400000	SCHS2	C.134
0337400000	SCHS2	F.22

## 0350000000

0354361187	DEK 5 FWZ L1-PE	E.3
0354361203	DEK 5 FWZ L1-EIK	E.3

## 0400000000

0407360001	DEK 6,5 FSZ 1-10	E.3
0407360011	DEK 6,5 FSZ 11-20	E.3

## 0460000000

0460660001	DEK 5 FSZ 1-10	E.3
0460660011	DEK 5 FSZ 11-20	E.3
0460660021	DEK 5 FSZ 21-30	E.3
0460660031	DEK 5 FSZ 31-40	E.3
0460660041	DEK 5 FSZ 41-50	E.3
0460660051	DEK 5 FSZ 51-60	E.3
0460660061	DEK 5 FSZ 61-70	E.3
0460660071	DEK 5 FSZ 71-80	E.3
0460660081	DEK 5 FSZ 81-90	E.3
0460660091	DEK 5 FSZ 91-100	E.3
0468160001	DEK 6,5 FW 1-50	E.3
0468160051	DEK 6,5 FW 51-100	E.3
0468160101	DEK 6,5 FW 101-150	E.3
0468260001	DEK 6,5 FS 1-50	E.3
0468260051	DEK 6,5 FS 51-100	E.3
0468260101	DEK 6,5 FS 101-150	E.3
0468660001	DEK 6 FW 1-50	E.3
0468660051	DEK 6 FW 51-100	E.3
0468660101	DEK 6 FW 101-150	E.3
0468660151	DEK 6 FW 151-200	E.3
0468660201	DEK 6 FW 201-250	E.3
0468660251	DEK 6 FW 251-300	E.3
0468660301	DEK 6 FW 301-350	E.3
0468660351	DEK 6 FW 351-400	E.3
0468660451	DEK 6 FW 451-500	E.3
0468660501	DEK 6 FW 501-550	E.3
0468660551	DEK 6 FW 551-600	E.3
0468660601	DEK 6 FW 601-650	E.3
0468660651	DEK 6 FW 651-700	E.3
0468660701	DEK 6 FW 701-750	E.3
0468660751	DEK 6 FW 751-800	E.3
0468660801	DEK 6 FW 801-850	E.3
0468660851	DEK 6 FW 851-900	E.3
0468660901	DEK 6 FW 901-950	E.3
0468660951	DEK 6 FW 951-999	E.3
0468760001	DEK 6 FS 1-50	E.3
0468760051	DEK 6 FS 51-100	E.3
0468760101	DEK 6 FS 101-150	E.3

## 0470000000

0473460001	DEK 5 FW 1-50	E.3
0473460051	DEK 5 FW 51-100	E.3
0473460101	DEK 5 FW 101-150	E.3
0473460151	DEK 5 FW 151-200	E.3
0473460201	DEK 5 FW 201-250	E.3
0473460251	DEK 5 FW 251-300	E.3
0473460301	DEK 5 FW 301-350	E.3
0473460351	DEK 5 FW 351-400	E.3
0473460401	DEK 5 FW 401-450	E.3
0473460451	DEK 5 FW 451-500	E.3
0473460501	DEK 5 FW 501-550	E.3
0473460551	DEK 5 FW 551-600	E.3
0473460601	DEK 5 FW 601-650	E.3
0473460651	DEK 5 FW 651-700	E.3
0473460701	DEK 5 FW 701-750	E.3
0473460751	DEK 5 FW 751-800	E.3
0473460801	DEK 5 FW 801-850	E.3
0473460851	DEK 5 FW 851-900	E.3
0473460901	DEK 5 FW 901-950	E.3
0473560001	DEK 5 FS 1-50	E.3
0473560051	DEK 5 FS 51-100	E.3
0473560101	DEK 5 FS 101-150	E.3
0473560151	DEK 5 FS 151-200	E.3
0473560201	DEK 5 FS 201-250	E.3

## 0500000000

0508401694	STI WATERPROOF SCHWARZ	C.13
0508401694	STI WATERPROOF SCHWARZ	C.16

## 0510000000

0515300000	STR 7 F.SCHT 7	F.4
0515300000	STR 7 F.SCHT 7	F.5
0515300000	STR 7 F.SCHT 7	F.8
0517960000	SCHT 7	F.8
0518960001	DEK 6 FWZ 1-10	E.3
0518960011	DEK 6 FWZ 11-20	E.3
0518960021	DEK 6 FWZ 21-30	E.3

Order No.	Type	Page
-----------	------	------

0518960031	DEK 6 FWZ 31-40	E.3
0518960041	DEK 6 FWZ 41-50	E.3
0518960051	DEK 6 FWZ 51-60	E.3
0518960061	DEK 6 FWZ 61-70	E.3
0518960071	DEK 6 FWZ 71-80	E.3
0518960081	DEK 6 FWZ 81-90	E.3
0518960091	DEK 6 FWZ 91-100	E.3
051896101	DEK 6 FWZ 101-110	E.3
0519060001	DEK 6,5 FWZ 1-10	E.3
0519060011	DEK 6,5 FWZ 11-20	E.3
0519060021	DEK 6,5 FWZ 21-30	E.3

## 0520000000

0522361075	DEK 5 GW L1	E.3
0522361076	DEK 5 GW L2	E.3
0522361077	DEK 5 GW L3	E.3
0522660001	DEK 5 GW 1	E.3
0522660002	DEK 5 GW 2	E.3
0522660003	DEK 5 GW 3	E.3
0522660004	DEK 5 GW 4	E.3
0522660005	DEK 5 GW 5	E.3
0522660006	DEK 5 GW 6	E.3
0522660007	DEK 5 GW 7	E.3
0522660008	DEK 5 GW 8	E.3
0522660009	DEK 5 GW 9	E.3
0522660010	DEK 5 GW 10	E.3
0522660011	DEK 5 GW 11	E.3
0522660012	DEK 5 GW 12	E.3
0522660013	DEK 5 GW 13	E.3
0522660014	DEK 5 GW 14	E.3
0522660015	DEK 5 GW 15	E.3
0522660016	DEK 5 GW 16	E.3
0522660017	DEK 5 GW 17	E.3
0522660018	DEK 5 GW 18	E.3
0522660019	DEK 5 GW 19	E.3
0522660020	DEK 5 GW 20	E.3
0522660021	DEK 5 GW 21	E.3
0522761021	DEK 5 GW A	E.3
0522761022	DEK 5 GW B	E.3
0522761026	DEK 5 GW F	E.3
0522761032	DEK 5 GW L	E.3
0522761034	DEK 5 GW N	E.3
0522761035	DEK 5 GW D	E.3
0522761038	DEK 5 GW R	E.3
0522761039	DEK 5 GW S	E.3
0522761040	DEK 5 GW T	E.3
0522761041	DEK 5 GW U	E.3
0522761042	DEK 5 GW V	E.3
0522761043	DEK 5 GW W	E.3
0522761044	DEK 5 GW X	E.3
0523060001	DEK 5 FWZ 1-10	E.3
0523060011	DEK 5 FWZ 11-20	E.3
0523060021	DEK 5 FWZ 21-30	E.3
0523060031	DEK 5 FWZ 31-40	E.3
0523060041	DEK 5 FWZ 41-50	E.3
0523060051	DEK 5 FWZ 51-60	E.3
0523060061	DEK 5 FWZ 61-70	E.3
0523060071	DEK 5 FWZ 71-80	E.3
0523060081	DEK 5 FWZ 81-90	E.3
0523060091	DEK 5 FWZ 91-100	E.3
0524400000	CLI MH 70 HSTR	E.51
0526960001	DEK 6 GW 1	E.3
0526960002	DEK 6 GW 2	E.3
0526960003	DEK 6 GW 3	E.3
0526960004	DEK 6 GW 4	E.3
0526960005	DEK 6 GW 5	E.3
0526960006	DEK 6 GW 6	E.3
0526960008	DEK 6 GW 8	E.3
0526960010	DEK 6 GW 10	E.3

## 0530000000

0532100000	CLI R 1 F. CLI C 1-3	E.51
0537261187	DEK 5 GW PE	E.3

## 0550000000

0558360000	DEK 5 FWZ U.V.W.N,PE	E.3
0559200000	CLI RS 3 MDCLI C 02	E.51
0559300000	CLI RS 4 MDCLI C1-02	E.51
0559900000	CLI R 02 F. CLI C 02-3	E.51

## 0560000000

0560001501	CLI R 02-3 GE/SW 0	E.33
0560001503	CLI R 02-3 SW/SW 0	E.33
0560001504	CLI R 02-3 GE/SW 1	E.33
0560001506	CLI R 02-3 BR/WS 1	E.33
0560001507	CLI R 02-3 GE/SW 2	E.33
0560001509	CLI R 02-3 RT/WS 2	E.33
0560001510	CLI R 02-3 GE/SW 3	E.33
0560001512	CLI R 02-3 OR/SW 3	E.33
0560001513	CLI R 02-3 GE/SW 4	E.33
0560001516	CLI R 02-3 GE/SW 5	E.33
0560001518	CLI R 02-3 GN/WS 5	E.33
0560001519	CLI R 02-3 GE/SW 6	E.33
0560001521	CLI R 02-3 BL/WS 6	E.33
0560001522	CLI R 02-3 GE/SW 7	E.33

Order No.	Type	Page
-----------	------	------

0560001524	CLI R 02-3 VI/WS 7	E.33
0560001525	CLI R 02-3 GE/SW 8	E.33
0560001527	CLI R 02-3 GR/SW 8	E.33
0560001528	CLI R 02-3 GE/SW 9	E.33
0560001530	CLI R 02-3 WS/SW 9	E.33
0560001638	CLI R 02-3 GE/SW A	E.34
0560001640	CLI R 02-3 GE/SW B	E.34
0560001642	CLI R 02-3 GE/SW C	E.34
0560001644	CLI R 02-3 GE/SW D	E.34
0560001646	CLI R 02-3 GE/SW E	E.34
0560001648	CLI R 02-3 GE/SW F	E.34
0560001650	CLI R 02-3 GE/SW G	E.34
0560001652	CLI R 02-3 GE/SW H	E.34
0560001654	CLI R 02-3 GE/SW I	E.34
0560001656	CLI R 02-3 GE/SW J	E.34
0560001658	CLI R 02-3 GE/SW K	E.34
0560001660	CLI R 02-3 GE/SW L	E.34
0560001662	CLI R 02-3 GE/SW M	E.34
0560001664	CLI R 02-3 GE/SW N	E.34
0560001666	CLI R 02-3 GE/SW O	E.34
0560001668	CLI R 02-3 GE/SW P	E.34
0560001670	CLI R 02-3 GE/SW Q	E.34
0560001672	CLI R 02-3 GE/SW R	E.34
0560001675	CLI R 02-3 GE/SW S	E.34
0560001678	CLI R 02-3 GE/SW T	E.34
0560001680	CLI R 02-3 GE/SW U	E.34
0560001682	CLI R 02-3 GE/SW V	E.34
0560001684	CLI R 02-3 GE/SW W	E.34
0560001687	CLI R 02-3 GE NE	E.32
0560001693	CLI R 02-3 GE/SW X	E.34
0560001695	CLI R 02-3 GE/SW 0	E.34
0560001697	CLI R 02-3 GE/SW Y	E.34
0560001698	CLI R 02-3 GE/SW A	E.34
0560001699	CLI R 02-3 GE/SW Z	E.34
0560001738	CLI R 02-3 GE/SW +	E.34
0560001739	CLI R 02-3 RT/WS +	E.35
0560001740	CLI R 02-3 GE/SW -	E.34
0560001741	CLI R 02-3 BL/WS -	E.35
0560001743	CLI R 02-3 GE/SW /	E.34
0560001749	CLI R 02-3 GE/SW /	E.34
0560009999	CLI R 02-3 SDR	E.32
0563600000	CLI RH 20-10 CLI R 10	E.51
0563700000	CLI RH 20-02 CLI R 02	E.51

## 0570000000

0572900002	CLI R 1-3 BL NE	E.32
0572901502	CLI R 1-3 SW/WS 0	E.35
0572901503	CLI R 1-3 GE/SW 0	E.35
0572901505	CLI R 1-3 BR/WS 0	E.35
0572901506	CLI R 1-3 GE/SW 1	E.35
0572901508	CLI R 1-3 RT/WS 2	E.35
0572901509	CLI R 1-3 GE/SW 2	E.35
0572901511	CLI R 1-3 OR/SW 3	E.35
0572901512	CLI R 1-3 GE/SW 3	E.35
0572901515	CLI R 1-3 GE/SW 4	E.35
0572901517	CLI R 1-3 GN/WS 5	E.35
0572901518	CLI R 1-3 GE/SW 5	E.35
0572901520	CLI R 1-3 BL/WS 6	E.35
0572901521	CLI R 1-3 GE/SW 6	E.35
0572901523	CLI R 1-3 VI/WS 7	E.35
0572901524	CLI R 1-3 GE/SW 7	E.35
0572901526	CLI R 1-3 GR/SW 8	E.35



Order No.	Type	Page
0648201520	CLI 0 30/3 GE/SW 6 MP	E.42
0648201523	CLI 0 30/3 GE/SW 7 MP	E.42
0648201526	CLI 0 30/3 GE/SW 8 MP	E.42
0648201529	CLI 0 30/3 GE/SW 9 MP	E.42
0648201637	CLI 0 30/3 GE/SW A MP	E.43
0648201639	CLI 0 30/3 GE/SW B MP	E.43
0648201641	CLI 0 30/3 GE/SW C MP	E.43
0648201643	CLI 0 30/3 GE/SW D MP	E.43
0648201645	CLI 0 30/3 GE/SW E MP	E.43
0648201647	CLI 0 30/3 GE/SW F MP	E.43
0648201649	CLI 0 30/3 GE/SW G MP	E.43
0648201651	CLI 0 30/3 GE/SW H MP	E.43
0648201653	CLI 0 30/3 GE/SW I MP	E.43
0648201655	CLI 0 30/3 GE/SW J MP	E.43
0648201657	CLI 0 30/3 GE/SW K MP	E.43
0648201659	CLI 0 30/3 GE/SW L MP	E.43
0648201661	CLI 0 30/3 GE/SW M MP	E.43
0648201663	CLI 0 30/3 GE/SW N MP	E.43
0648201665	CLI 0 30/3 GE/SW O MP	E.43
0648201667	CLI 0 30/3 GE/SW P MP	E.43
0648201669	CLI 0 30/3 GE/SW Q MP	E.43
0648201671	CLI 0 30/3 GE/SW R MP	E.43
0648201673	CLI 0 30/3 GE/SW S MP	E.43
0648201676	CLI 0 30/3 GE/SW T MP	E.43
0648201679	CLI 0 30/3 GE/SW U MP	E.43
0648201681	CLI 0 30/3 GE/SW V MP	E.43
0648201683	CLI 0 30/3 GE/SW W MP	E.43
0648201687	CLI 0 30/3 GE/SW X MP	E.43
0648201695	CLI 0 30/3 GE/SW Y MP	E.43
0648201696	CLI 0 30/3 GE/SW Z MP	E.43
0648201697	CLI 0 30/3 GE/SW A MP	E.43
0648201698	CLI 0 30/3 GE/SW B MP	E.43
0648201699	CLI 0 30/3 GE/SW C MP	E.43
0648201738	CLI 0 30/3 GE/SW + MP	E.43
0648201740	CLI 0 30/3 GE/SW - MP	E.43
0648201746	CLI 0 30/3 GE/SW ET MP	E.43
0648209999	CLI 0 30/3 SDR MP	E.40
0648300000	CLI RS 5 MDCU C 1	E.51

## 0680000000

0689600000	CLI 0 10/3 GE NE MP	E.39
0689700000	CLI 0 20/3 GE NE MP	E.39
0689800000	CLI 0 30/3 GE NE MP	E.39

## 1000000000

1001140001	ESG X20 MC NE WS	C.142
1001150001	ESG X20 MC NE BL	C.142
1001160001	ESG X20 MC NE OR	C.142
1001170001	ESG X20 MC NE RT	C.142
1002680000	WSMH 176MM	E.56
1003380000	THM WO T 24.5/100 WS	D.21
1003400000	LM MT300 89/340 WS	D.46
1003410000	THM MT30X 89/60 SI	D.42
1003420000	THM WO T 24.5/62 WS	D.21
1005710000	PLOTTER PEN 0.50 PINK	C.13
1005710000	PLOTTER PEN 0.50 PINK	C.15
1009320000	CC 30/60 MC NE GE	C.162

## 1010000000

1010860000	ESG 9/20 L MC NE GE	C.139
1011320000	DEK 5/6 PLUS MC NE WS	C.30
1011410000	MF-W 9/6.2F MC NE WS	C.69
1011420000	MF-W 9/6.2F MC NE WS	C.70
1011430000	MF-W 9/4.2F MC NE WS	C.67
1011440000	PLOTTERPEN 0,7	C.13
1011440000	PLOTTERPEN 0,7	C.15
1011450000	PLOTTER PEN 0.70 PINK	C.13
1011450000	PLOTTER PEN 0.70 PINK	C.15
1011610000	THM MT30X 38/17 WS	D.41
1014840000	SM 27/18 MC NE GR	C.151
1014850000	SM 22/22 K MC NE GR	C.150
1014860000	THM MT30X 30/52 SI	D.41
1015220000	SCT-C 4.6/100	G.32
1015230000	SCT-C 4.6/125	G.32
1015240000	SCT-C 4.6/150	G.32
1015250000	SCT-C 4.6/200	G.32
1015270000	SCT-C 4.6/360	G.32
1015280000	SCT-C 4.6/520	G.32
1015290000	SCT-C 4.6/680	G.32
1015300000	SCT-C 4.6/840	G.32
1015310000	SCT-C 7.9/200	G.32
1015320000	SCT-C 7.9/360	G.32
1015330000	SCT-C 7.9/520	G.32
1015340000	SCT-C 7.9/680	G.32
1015350000	SCT-C 7.9/840	G.32
1016030000	DMC 12/27 MC NE WS	C.125
1018190000	DMC 12/27 MC NE GE	C.125

## 1020000000

1025220000	SFC 3/12 MC NE WS	C.111
1025230000	SFC 3/12 MC NE GE	C.111
1025240000	SFC 3/12 MC NE RT	C.111
1025250000	SFC 3/12 MC NE BL	C.111
1025260000	SFC 3/21 MC NE WS	C.111
1025270000	SFC 3/21 MC NE GE	C.111

Order No.	Type	Page
1025290000	SFC 3/21 MC NE RT	C.111
1025300000	SFC 3/21 MC NE BL	C.111
1025310000	SFC 3/30 MC NE WS	C.111
1025320000	SFC 3/30 MC NE GE	C.111
1025330000	SFC 3/30 MC NE RT	C.111
1025340000	SFC 3/30 MC NE BL	C.111
1025550000	SFC 3/12 MC SDR	C.111
1025560000	SFC 3/21 MC SDR	C.111
1025570000	SFC 3/30 MC SDR	C.111
1025680000	DEK 5/30 MC SDR	C.33
1026550000	ESG X20 10/7 MC NE WS	C.142
1026560000	ESG X20 10/7 MC NE BL	C.142
1026570000	ESG X20 10/7 MC NE RT	C.142
1026580000	ESG X20 10/7 MC NE DR	C.142
1027280000	ESG-M 9/17 MC NE WS	C.144
1027290000	ESG-M 8/20 MC NE WS	C.144
1027310000	MF-W 9/5 MC NE GE	C.68
1027620000	THM MT30X 17/8 GE	D.41
1027830000	SM 27/12.5 K MC NE GR	C.151

## 1030000000

1038650000	DEK 5/6 PLUS MC SDR	C.30
1038670000	MF 12/5 MC CABUR SDR	C.60
1038690000	MF 4/5/2 MC SDR	C.60
1038730000	MF 5/10 MC SDR	C.63
1038750000	MF-W 9/4.2F MC SDR	C.67
1038760000	MF-W 9/5.2F MC SDR	C.69
1038770000	MF-W 9/6.2F MC SDR	C.70
1038790000	WS 8/5 PLUS MC SDR	C.36
1038820000	WS 8/6 PLUS MC SDR	C.41
1038830000	DMC 12/27 MC SDR	C.125
1038840000	ESG 5/10 MC SDR	C.127
1038850000	ESG 8/11 MC SDR	C.132
1038860000	ESG 8/13.5/43.3 SAI SDR	C.132
1038870000	ESG 8/17 L MC SDR	C.133
1038880000	ESG 9/10 MC SDR	C.136
1038890000	ESG X20 MC SDR	C.142
1038910000	ESG-M 8/20 MC SDR	C.144
1038920000	ESG-M 9/17 MC SDR	C.144
1038930000	ESG X20 10/7 MC SDR	C.142
1038940000	ESG 9/6 MC SDR	C.141

## 1040000000

1045490000	ET S7-200-TU-A4-2	D.45
1045500000	ET S7-200-TU-A4-1	D.45
1045670000	ELS 6/30 MC NE WS	C.115
1045670000	ELS 6/30 MC NE WS	C.115
1045670000	ELS 6/30 MC NE WS	F.17
1045670000	ELS 6/30 MC NE WS	F.4
1045670000	ELS 6/30 MC NE WS	F.8
1045680000	ELS 6/30 MC NE GE	C.115
1045680000	ELS 6/30 MC NE GE	C.115
1045680000	ELS 6/30 MC NE GE	F.17
1045680000	ELS 6/30 MC NE GE	F.4
1045620000	ELS 16/40 MC NE WS	C.100
1045620000	ELS 16/40 MC NE WS	C.115
1045620000	ELS 16/40 MC NE WS	F.18
1045620000	ELS 16/40 MC NE WS	F.7
1045620000	ELS 16/40 MC NE WS	F.7
1045630000	ELS 16/40 MC NE GE	C.100
1045630000	ELS 16/40 MC NE GE	C.115
1045630000	ELS 16/40 MC NE GE	F.18
1045630000	ELS 16/40 MC NE GE	F.7
1045640000	ELS 7/40 MC NE WS	C.99
1045650000	ELS 7/40 MC NE GE	C.99
1045650000	ELS 7/40 MC NE GE	F.7
1045660000	ELS 6/30 MC SDR	C.115
1045660000	ELS 6/30 MC SDR	C.99
1045690000	ELS 16/40 MC SDR	C.100
1045690000	ELS 16/40 MC SDR	C.115
1045700000	ELS 7/40 MC SDR	C.99
1045980000	MF-W 9/5F MC NE GR	C.68
1046320000	WS 10/5 PLUS MC SDR	C.37
1046330000	WS 10/6 PLUS MC SDR	C.42
1046340000	DEK 5/6.5 PLUS MC NE WS	C.31
1046350000	DEK 5/8 PLUS MC NE WS	C.32
1046360000	DEK 5/6.5 PLUS MC SDR	C.31
1046370000	DEK 5/8 PLUS MC SDR	C.32
1046380000	WS 10/5 PLUS MC NE WS	C.37
1046390000	WS 10/6 PLUS MC NE WS	C.42

## 1050000000

1051870000	SFX 11/60 MC NE BL	C.109
1057580000	CC 15/60 04MM MC NE WS	C.161
1058090000	MCP EP SFC 3	C.13
1058090000	MCP EP SFC 3	C.15
1058740000	THM MT30X 15/9 GE	D.41
1058750000	THM MT30X 15/9 WS	D.41
1058770000	THM MT30X 100/90 SI	D.42
1059200000	CB-R 200/7.5 NATUR	G.30
1059210000	CB-R 200/7.5 BLACK	G.30
1059220000	CB-R 250/7.5 NATUR	G.30
1059230000	CB-R 250/7.5 BLACK	G.30
1059240000	CB-R 350/7.5 NATUR	G.30
1059250000	CB-R 350/7.5 BLACK	G.30
1059780000	THM GEW 15/6 WS	D.43

Order No.	Type	Page
1059790000	THM GEW 15/6 GE	D.43
1059800000	THM GEW 17/9 WS	D.43
1059810000	THM GEW 17/9 GE	D.43
1059820000	THM GEW 18/6 WS	D.43
1059830000	THM GEW 18/6 GE	D.43
1059840000	THM GEW 18/9 WS	D.43
1059850000	THM GEW 18/9 GE	D.43
1059870000	THM GEW 20/8 WS	D.43
1059880000	THM GEW 20/8 GE	D.43
1059990000	CC 15/60 04MM MC NE SI	C.161

## 1060000000

1060010000	CC 15/60 04MM MC SDR	C.161
1061810000	THM MT30X 101/74 GE	D.42
1062000000	SFC 2.5/12 MC NE WS	C.111
1062010000	SFC 2.5/12 MC NE GE	C.111
1062020000	SFC 2.5/12 MC NE RT	C.111
1062030000	SFC 2.5/12 MC NE BL	C.111
1062040000	SFC 2.5/12 MC SDR	C.111
1062050000	SFC 2.5/21 MC NE WS	C.111
1062070000	SFC 2.5/21 MC NE GE	C.111
1062080000	SFC 2.5/21 MC NE RT	C.111
1062090000	SFC 2.5/21 MC NE BL	C.111
1062110000	SFC 2.5/21 MC SDR	C.111
1062860000	WAD 27/12.5 K MC NE GE	F.3
1062960000	WAD 27 NEUTRAL	F.3
1069080000	WS 10/6 MC M NE BL	C.42
1069090000	WS 10/6 MC M NE VI	C.42

## 1070000000

1072640000	CC 15/60 MC NE GR	C.161
1072650000	CC 15/60 K MC NE GR	C.161
1072670000	CC 30/60 MC NE GR	C.162
1072680000	CC 30/60 K MC NE GR	C.162
1072690000	THM MT30X 15/4 GE	D.41
1073340000	SM 27/18 K MC NE GR	C.151
1076890000	SFX 11/60 MC NE GE VO	C.109
1076970000	CC 15/49 MC NE GE	C.160
1078320000	CC 30/60 K MC NE GE	C.162
1079470000	SM 27/8 MC NE GR	C.150
1079480000	SM 27/8 K MC NE GR	C.150
1079490000	SM 27/12.5 MC NE GR	C.151
1079510000	SM 27/27 MC NE GR	C.152
1079520000	SM 27/27 K MC NE GR	C.152
1079530000	CC 15/17 MC NE GR	C.159
1079540000	CC 15/17 K MC NE GR	C.159
1079550000	CC 15/27 MC NE GR	C.159
1079560000	CC 15/27 K MC NE GR	C.159
1079570000	CC 15/49 MC NE GR	C.160
1079580000	CC 15/49 K MC NE GR	C.160

## 1080000000

1082490000	ESG 6.6/11 BHZ 5.00/02	C.129
1082520000	ESG 6.6/15 BHZ 5.00/03	C.130
1082540000	ESG 6.6/20 BHZ 5.00/04	C.130
1083150000	CC 30/60 04MM MC NE WS	C.163
1083160000	CC 30/60 04MM MC NE GE	C.163
1083170000	CC 30/60 04MM MC NE GR	C.163
1083190000	CC 30/60 04MM MC SDR	C.163
1083230000	SFX 30/60 MC NE WS	C.109
1083240000	SFX 30/60 MC NE GE	C.109
1083260000	SFX 30/60 MC SDR	C.109
1085430000	CC 30/60 K MC NE RT	C.162
1085440000	THM MT30X 20/100 WS	D.41

## 1090000000

1095590000	THM ET S7 50/25 GE	D.44
1096170000	THM EL VIN 15 WS 5L 30M	D.43

## 1100000000

1105550000	THM EL VIN 24 WS 3L 30M	D.43
1105560000	THM EL VIN 38 WS 30M	D.43
1107340000	TABPACK FLAG 54/8 WS	E.59
1109130000	THM WO 24.5/62 WS	D.21
1109140000	THM WO 25.4/95.2 WS	D.21
1109150000	THM WO 50.8/150 WS	D.21
1109170000	THM WO 50.8/150 RT	D.21
1109180000	THM WO 50.8/150 GE	D.21
1109190000	THM WO 50.8/150 BL	D.21

Order No.	Type	Page
1248510000	CC 85/54 04MM MC NE GR	C.165
1248520000	CC DIA 30/4,2 MC NE WS	C.166
1248530000	CC DIA 30/4,2 MC NE GE	C.166
1248540000	CC DIA 30/4,2 MC NE GR	C.166
1248550000	SM 18/9,5 K MC SDR	C.149
1248560000	SM 19/42 K MC SDR	C.149
1248570000	SM 45/45-24 MC SDR	C.155
1248580000	SM 18/9,5 K MC NE WS	C.149
1248590000	SM 18/9,5 K MC NE GE	C.149
1248610000	SM 18/9,5 K MC NE GR	C.149
1248620000	SM 19/42 K MC NE WS	C.149
1248630000	SM 19/42 K MC NE GE	C.149
1248640000	SM 19/42 K MC NE GR	C.149
1248650000	SM 45/45-24 MC NE WS	C.155
1248660000	SM 45/45-24 MC NE GE	C.155
1248670000	SM 45/45-24 MC NE GR	C.155
1248740000	SFX 9/40 S MC SDR	C.109
1248750000	SFX 10/60 S MC SDR	C.109
1248760000	SFX 9/40 S MC NE WS	C.109
1248770000	SFX 9/40 S MC NE GE	C.109
1248780000	SFX 9/40 S MC NE RT	C.109
1248790000	SFX 9/40 S MC NE BL	C.109
1248810000	SFX 10/60 S MC NE WS	C.109
1248820000	SFX 10/60 S MC NE GE	C.109
1248830000	SFX 10/60 S MC NE RT	C.109
1248840000	SFX 10/60 S MC NE BL	C.109

## 1250000000

1250080000	MF 5/12 MC SDR	C.64
1250090000	MF 5/12 MC NE WS	C.64
1251510000	THM WO VIN 25/25 WS	D.22

## 1260000000

1266120000	CC DIA 30/3,5 MC NE WS	C.165
1266130000	CC DIA 30/3,5 MC NE GE	C.165
1266140000	CC DIA 30/3,5 MC NE GR	C.165
1266150000	CC DIA 30/3,5 SDR	C.165

## 1270000000

1270640000	WS 7,8/9,2 PLUS MC SDR	C.46
1276960001	DEK 8 FWZ 1-10	E.3
1276960011	DEK 8 FWZ 11-20	E.3
1276960021	DEK 8 FWZ 21-30	E.3
1276960031	DEK 8 FWZ 31-40	E.3
1276960041	DEK 8 FWZ 41-50	E.3
1276960051	DEK 8 FWZ 51-60	E.3
1278600000	CB 98/2,5 NATUR	G.30
1278700000	CB 140/3,5 NATUR	G.30
1278800000	CB 200/4,5 NATUR	G.30
1278900000	CB 290/4,5 NATUR	G.30
1279000000	CB 360/4,5 NATUR	G.30
1279100000	CB 365/7,5 NATUR	G.30
1279200000	CBH 8.1/6.2 NATUR	G.33
1279300000	CBDM 200/4,5 NA	G.33

## 1280000000

1288320000	CC 15/17 K MC NE RT	C.159
1288330000	CC 15/27 K MC NE RT	C.159
1288340000	CC 15/60 K MC NE RT	C.161
1288380000	CC 15/49 K MC NE RT	C.160
1288390000	CC 85/54 K MC NE RT	C.164
1289200000	CBH 19/19 NATUR	G.33
1289400000	CBH 27/27 NATUR	G.33
1289660001	DEK 8 FSZ 1-10	E.3
1289660011	DEK 8 FSZ 11-20	E.3
1289660021	DEK 8 FSZ 21-30	E.3
1289660031	DEK 8 FSZ 31-40	E.3
1289660041	DEK 8 FSZ 41-50	E.3
1289660051	DEK 8 FSZ 51-60	E.3

## 1290000000

1296000000	KABELBINDERZANGE RT-1	G.33
------------	-----------------------	------

## 1300000000

1302920000	THM MMP EXT.RH	D.5
1304060000	CC 15/60 04MM MC NE GR	C.161
1307670000	THM EL VIN 15 WS 2L 30M	D.43

## 1310000000

1310540000	THM MT30X 8/8 GE	D.41
1317010000	THM MT30X 24/157 SI	D.41
1318061187	DEK 6 GW PE	E.3
1318061198	DEK 6 GW -	E.3
1318061199	DEK 6 GW -	E.3
1318061202	DEK 6 GW ERDE	E.3
1318640000	SFR 1/12 MC NE WS	C.107
1318650000	SFR 1/12 MC NE GE	C.107
1318660000	SFR 2/12 MC NE WS	C.118
1318670000	SFR 2/12 MC NE GE	C.107
1318680000	SFR 3/12 MC NE WS	C.107
1318690000	SFR 3/12 MC NE GE	C.107
1318710000	SFR 1/21MC NE WS	C.107

Order No.	Type	Page
1318720000	SFR 1/21 MC NE GE	C.107
1318730000	SFR 2/21 MC NE WS	C.107
1318740000	SFR 2/21 MC NE GE	C.107
1318750000	SFR 3/21 MC NE WS	C.107
1318760000	SFR 3/21 MC NE GE	C.107
1318770000	SFR 1/12 MC SDR	C.107
1318780000	SFR 2/12 MC SDR	C.107
1318790000	SFR 3/12 MC SDR	C.107
1318810000	SFR 1/21 MC SDR	C.107
1318820000	SFR 2/21 MC SDR	C.107
1318830000	SFR 3/21 MC SDR	C.107

## 1320000000

1323440000	SFX 9/24 S MC NE WS	C.109
1323450000	SFX 9/24 S MC NE GE	C.109
1323470000	SFX 9/24 S MC NE RT	C.109
1323480000	SFX 9/24 S MC NE BL	C.109
1323490000	SFX 9/24 S MC SDR	C.109
1323500000	SM 46/46-30 MC NE WS	C.156
1323510000	SM 46/46-30 MC NE GE	C.156
1323520000	SM 46/46-30 MC NE GR	C.156
1323530000	SM 42/42-30 K MC NE WS	C.154
1323540000	SM 42/42-30 K MC NE GE	C.154
1323550000	SM 42/42-30 K MC NE GR	C.154
1323570000	SM 44/44-21 MC NE WS	C.155
1323580000	SM 44/44-21 MC NE GE	C.155
1323600000	SM 44/44-21 MC NE GR	C.155
1323610000	SM 46/46-30 MC SDR	C.156
1323620000	SM 42/42-30 K MC SDR	C.154
1323640000	SM 44/44-21 MC SDR	C.155
1323700000	PM 2,7/2,6 MC SDR	C.48
1323710000	PM 2,7/2,6 MC NE	C.48
1323720000	TMH 12/18 MC SDR	C.113
1323730000	TMH 12/18 MC NE WS	C.113
1323740000	SM DIA 60-22 MC SDR	C.156
1323750000	SM DIA 60-22 K MC NE GE	C.156
1327600000	CC-M 85/54 AL	C.175
1327620000	CC-M 85/54 ST	C.175
1327630000	CC-M 27/18 AL	C.169
1327640000	CC-M 27/18 ST	C.169
1327650000	CC-M 85/27 AL	C.170
1327670000	CC-M 85/27 ST	C.170
1327680000	CC-M 30/60 AL	C.177
1327690000	CC-M 30/60 ST	C.177
1327700000	CC-M 15/60 AL	C.176
1327720000	CC-M 15/60 ST	C.176
1327730000	CC-M 15/45 AL	C.172
1327740000	CC-M 15/45 ST	C.172
1327750000	CC-M DIA 30 AL	C.179
1327770000	CC-M DIA 30 ST	C.179
1327780000	SFX-M 11/60 AL	C.117
1327790000	SFX-M 11/60 ST	C.117
1327800000	CC-M 85/54 4X3 AL	C.175
1327820000	CC-M 85/54 4X3 ST	C.175
1327830000	CC-M 85/27 2X3 AL	C.170
1327840000	CC-M 85/27 2X3 ST	C.170
1327850000	CC-M 30/60 2X3 AL	C.177
1327870000	CC-M 30/60 2X3 ST	C.177
1327880000	CC-M 15/60 2X3 AL	C.176
1327890000	CC-M 15/60 2X3 ST	C.176
1327900000	CC-M 15/45 2X3 AL	C.173
1327920000	CC-M 15/45 2X3 ST	C.173

## 1330000000

1331600000	THM MMP CUTTER	D.5
1335100000	THM GEW 38/19 GE	D.43
1336680000	SM 37,5/17 MC SDR	C.153
1336710000	SM 37,5/17 MC NE WS	C.153
1336720000	SM 37,5/17 MC NE GR	C.153
1338280000	THM MT30X 17,5/17,5 SI	D.41
1338650000	PJ ADV TMTK INK Y	C.11
1338670000	PJ ADV TMTK INK M	C.11
1338680000	PJ ADV TMTK INK C	C.11
1338690000	PJ ADV TMTK INK K	C.11
1338710000	PJ ADV TNAW	C.11
1338720000	PJ ADV TMTK INK SET	C.11
1339570000	THM ESO 7 PA WS	F.17
1339580000	THM ESO 7 PA GE	F.17

## 1340000000

1341030000	INLAY CC-M 85/54	C.175
1341040000	INLAY CC-M 27/18	C.169
1341050000	INLAY CC-M 85/27	C.170
1341070000	INLAY CC-M 30/60	C.177
1341080000	INLAY CC-M 15/60	C.113
1341090000	INLAY CC-M 15/45	C.172
1341090000	INLAY CC-M 15/45	C.173
1341100000	INLAY CC-M DIA 30	C.179
1341110000	INLAY SFX-M 11/60	C.117
1341110000	INLAY SFX-M 11/60	C.118
1341120000	INLAY CC-M UNIVERSAL	C.118
1341120000	INLAY CC-M UNIVERSAL	C.117
1341120000	INLAY CC-M UNIVERSAL	C.169
1341120000	INLAY CC-M UNIVERSAL	C.170
1341120000	INLAY CC-M UNIVERSAL	C.172
1341120000	INLAY CC-M UNIVERSAL	C.173

Order No.	Type	Page
1341120000	INLAY CC-M UNIVERSAL	C.175
1341120000	INLAY CC-M UNIVERSAL	C.176
1341120000	INLAY CC-M UNIVERSAL	C.177
1341120000	INLAY CC-M UNIVERSAL	C.179
1341130000	DKB CC 30/60	C.177
1341140000	DKB CC 27/18	C.169
1341150000	DKB CC 15/60	C.176
1341170000	DKB CC 15/45	C.172
1341180000	DKB CC DIA 30	C.179
1341590000	DEK 5/5 S MC SDR	C.29
1341620000	DEK 5/5 S MC NE WS	C.29
1341630000	DEK 5/8-11,5 MC NE WS	C.33
1346130000	SM 27/18 MC NE GN	C.151
1346320000	ESG 6,6/15 BHZ 5,00 SDR	C.130
1346330000	ESG 6,6/11 BHZ 5,00 SDR	C.129

## 1350000000

1356490000	THM MT30X 32/9 GE	D.41
1356500000	THM MT30X 17/9 SI	D.41
1356520000	THM EL 24 SI 3L 30M	D.43
1357420000	THM MMP ROLLER 115	D.5
1357420000	THM MMP ROLLER 115	D.7
1358460000	DEK 5 FW 1,3,5...99	E.3
1358560000	DEK 5 FW 2,4...100	E.3
1358660000	DEK 6 FW 1,3,5...99	E.3
1358760000	DEK 6 FW 2,4...100	E.3

## 1360000000

1364020000	DEK 5/6,5 PLUS MC NE GE	C.31
1366530000	THM GEW 15/9 GE	D.43
1368740000	THM GEW 45/23 GE	D.43
1369480000	DEK 5/3,5 MC NE GE	F.6
1369540000	SFX 30/60 MC NE BL	C.109
1369550000	SFX 30/60 MC NE RT	C.109

## 1370000000

1378110000	THM MT30X 63,5/50,8 SI	D.42
1378120000	THM MT30X 45,4/50,8 SI	D.41
1378130000	THM MT30X 76,2/50,8 WS	D.42
1378710000	ESG 6/15 RIDER MC NE GE	C.128
1378720000	DEK 5/6 PLUS MC NE OR	C.30

## 1380000000

1382930000	THM WO VIN 17,8/34 WS	D.22
1382940000	THM WO VIN 12/18 WS	D.22

## 1390000000

1390400000	CC-M 18/52 2X3 AL	C.174
1390430000	INLAY CC-M 18/52	C.174
1391380000	THM GEW 20/12 GE	D.43
1391390000	THM MT30X 12/8 GE	D.41
1391400000	THM EL 60 SI 50M	D.43
1391410000	THM WO VIN 24,5/62 WS	D.22
1391430000	THM WO VIN 24,5/100 WS	D.22

## 1400000000

1409630000	TMH 12/18 MC NE GE	C.113
------------	--------------------	-------

## 1410000000

1411800000	ELS 16/40 K MC NE WS	C.100
1411800000	ELS 16/40 K MC NE WS	C.115
1415670000	CC-M 58/35 2X3 ST	C.172
1415680000	CC-M 70/48 2X3 ST	C.174
1415710000	CC-M 58/35 2X3 AL	C.172
1415720000	CC-M 70/48 2X3 AL	C.174
1415730000	CC-M 58/35 ST	C.171
1415740000	CC-M 70/48 ST	C.173
1415750000	CC-M 58/35 AL	C.171
1415770000	CC-M 70/48 AL	C.173
1415940000	INLAY CC-M 70/48	C.174
1415940000	INLAY CC-M 70/48	C.173
1415950000	INLAY CC-M 58/35	C.171
1415950000	INLAY CC-M 58/35	C.172
1416330000	THM MMP PERFORATOR	D.5
1419980000	THM EL 100 GE 30M	D.43

## 1420000000

1420010000	THM EL 100 WS 30M	D.43
1421160000	TMH 12/18 MC NE BL	C.113
1421170000	TMH 12/18 MC NE RT	C.113
1422560000	SFX-M 11/60-5 AL	C.117
1422570000	SFX-M 11/60-5 ST	C.117

Order No.	Type	Page
1489580000	HSS 4.2-12.7 EL Y13M	D.29
1489590000	HSS 6.4-19.1 EL Y10M	D.28
1489610000	HSS 8.5-25.4 EL Y10M	D.28
1489620000	HSS 0.8-2.4 EL W13M	D.29
1489630000	HSS 1.0-3.2 EL W13M	D.29
1489640000	HSS 1.6-4.8 EL W13M	D.29
1489650000	HSS 2.1-6.4 EL W13M	D.29
1489660000	HSS 3.2-9.5 EL W13M	D.29
1489670000	HSS 4.2-12.7 EL W13M	D.29
1489680000	HSS 6.4-19.1 EL W10M	D.28
1489690000	HSS 8.5-25.4 EL W10M	D.28

## 1490000000

1498780000	THM MT30X 89/60 WS	D.42
1498790000	THM MT30X 76/25 WS	D.42

## 1500000000

Order No.	Type	Page
1500150000	CC-M 10/30 2X2.5 ST	C.171
1500170000	CC-M 27/70 2X3 AL	C.178
1500190000	CC-M 27/70 2X3 ST	C.178
1500200000	CC-M 43/70 AL	C.178
1500220000	CC-M 43/70 ST	C.178
1500230000	SFX-M 12/40-5 AL	C.118
1500240000	SFX-M 12/40-5 ST	C.118
1500250000	SFX-M 17/60-5 AL	C.118
1500270000	SFX-M 17/60-5 ST	C.118
1500290000	INLAY CC-M 27/70	C.178
1500300000	INLAY CC-M 43/70	C.178
1500330000	INLAY SFX-M 17/60	C.118
1500340000	DKB CC 43/70	C.178
15005140000	CC-M 10/30 2X2.5 AL SDR	C.171
15005150000	CC-M 10/30 2X2.5 ST SDR	C.171
15005160000	CC-M 27/70 2X3 AL SDR	C.178
15005170000	CC-M 27/70 2X3 ST SDR	C.178
15005180000	CC-M 43/70 AL SDR	C.178
15005190000	CC-M 43/70 ST SDR	C.178
15005210000	SFX-M 12/40-5 AL SDR	C.118
15005220000	SFX-M 12/40-5 ST SDR	C.118
15005230000	SFX-M 17/60-5 AL SDR	C.118
15005240000	SFX-M 17/60-5 ST SDR	C.118
15005350000	CC-M 18/52 2X3 ST	C.174
15005360000	CC-M 18/52 2X3 AL SDR	C.174
15005370000	CC-M 18/52 2X3 ST SDR	C.174
15005760000	HSS 0.8-2.4 EL Y30M	D.29
15005770000	HSS 1.0-3.2 EL Y30M	D.29
15005780000	HSS 1.6-4.8 EL Y30M	D.29
15005790000	HSS 2.1-6.4 EL Y30M	D.29
15005800000	HSS 3.2-9.5 EL Y30M	D.29
15005810000	HSS 4.2-12.7 EL Y30M	D.29
15005820000	HSS 6.4-19.1 EL Y30M	D.29
15005830000	HSS 8.5-25.4 EL Y30M	D.29
15005840000	HSS 0.8-2.4 EL W30M	D.29
15005850000	HSS 1.0-3.2 EL W30M	D.29
15005860000	HSS 1.6-4.8 EL W30M	D.29
15005870000	HSS 2.1-6.4 EL W30M	D.29
15005880000	HSS 3.2-9.5 EL W30M	D.29
15005890000	HSS 4.2-12.7 EL W30M	D.29
15005900000	HSS 6.4-19.1 EL W30M	D.29
15005910000	HSS 8.5-25.4 EL W30M	D.29
1507060000	TM 201/23 VO	F.13
1507070000	TM 202/23 VO	F.13
1507080000	TM 203/23 VO	F.13
1507090000	TM 204/23 VO	F.13
1507100000	TM 205/23 VO	F.13
1507110000	TM 206/23 VO	F.13

## 1510000000

1513140000	HSS-HF 1.2-2.4 EL Y30M	D.31
1513150000	HSS-HF 1.6-3.2 EL Y30M	D.31
1513170000	HSS-HF 2.4-4.8 EL Y30M	D.31
1513180000	HSS-HF 3.2-6.4 EL Y30M	D.31
1513190000	HSS-HF 4.8-9.5 EL Y30M	D.31
1513200000	HSS-HF 6.4-12.7 EL Y30M	D.31
1513210000	HSS-HF 9.5-19.1 EL Y30M	D.31
1513230000	HSS-HF 12.7-25.4 EL Y30M	D.31
1513240000	HSS-HF 1.2-2.4 EL W30M	D.31
1513250000	HSS-HF 1.6-3.2 EL W30M	D.31
1513270000	HSS-HF 2.4-4.8 EL W30M	D.31
1513280000	HSS-HF 3.2-6.4 EL W30M	D.31
1513290000	HSS-HF 4.8-9.5 EL W30M	D.31
1513300000	HSS-HF 6.4-12.7 EL W30M	D.31
1513320000	HSS-HF 9.5-19.1 EL W30M	D.31
1513330000	HSS-HF 12.7-25.4 EL W30M	D.31
1516990000	THM MT30X 16.5/5.1 GE	D.41
1517180000	THM EL 30 WS 30M	0.43
1517190000	THM EL 30 GE 30M	0.43
1517200000	THM EL 30 SI 30M	0.43
1517220000	THM EL 50 WS 30M	0.43
1517230000	THM EL 50 GE 30M	0.43
1517240000	THM EL 50 SI 30M	0.43
1517270000	THM EL 100 SI 30M	0.43

## 1520000000

1520930000	CC 85/27 MC NE WS	C.163
1520940000	CC 85/27 MC NE GE	C.163

Order No.	Type	Page
1520970000	CC 85/27 MC NE GR	C.163
1520980000	ESG 9/26 SCM ECO MC NE WS	C.143
1520990000	ESG 9/26 SCM ECO MC NE GE	C.143
1521000000	ESG 9/26 SCM ECO MC NE GR	C.143
1521010000	MF 5/3.5 MC NE WS	C.56
1521040000	MF-W 9/3.5F MC NE WS	C.66
1525800000	ESG 9/26 SCM ECO MC SDR	C.143
1525830000	MF-W 9/3.5F MC SDR	C.66
1525840000	MF 5/3.5 MC SDR	C.56
1525850000	CC 85/27 MC SDR	C.163
1526100000	CC 85/27 K MC NE WS	C.163
1526120000	CC 85/27 K MC NE GE	C.163
1526130000	CC 85/27 K MC NE GR	C.163
1526140000	CC 85/27 K MC SDR	C.163

## 1530000000

1538740000	THM MT30X 65/35 RT	D.42
------------	--------------------	------

## 1540000000

1540770000	THM PLUS M PERFORATOR	D.7
------------	-----------------------	-----

## 1560000000

1562640000	HSS-HF 1.2-2.4 EL Y75M	D.32
1562650000	HSS-HF 1.6-3.2 EL Y75M	D.32
1562670000	HSS-HF 2.4-4.8 EL Y75M	D.32
1562680000	HSS-HF 3.2-6.4 EL Y75M	D.32
1562690000	HSS-HF 4.8-9.5 EL Y75M	D.32
1562700000	HSS-HF 6.4-12.7 EL Y75M	D.32
1562720000	HSS-HF 9.5-19.1 EL Y50M	D.31
1562730000	HSS-HF 12.7-25.4 EL Y50M	D.31
1562740000	HSS-HF 1.2-2.4 EL R30M	D.31
1562750000	HSS-HF 1.6-3.2 EL R30M	D.31
1562770000	HSS-HF 2.4-4.8 EL R30M	D.31
1562780000	HSS-HF 3.2-6.4 EL R30M	D.31
1562790000	HSS-HF 4.8-9.5 EL R30M	D.31
1562800000	HSS-HF 6.4-12.7 EL R30M	D.31
1562820000	HSS-HF 9.5-19.1 EL R30M	D.31
1562830000	HSS-HF 12.7-25.4 EL R30M	D.31
1562840000	HSS-HF 1.2-2.4 EL B30M	D.31
1562850000	HSS-HF 1.6-3.2 EL B30M	D.31
1562870000	HSS-HF 2.4-4.8 EL B30M	D.31
1562880000	HSS-HF 3.2-6.4 EL B30M	D.31
1562890000	HSS-HF 4.8-9.5 EL B30M	D.31
1562900000	HSS-HF 6.4-12.7 EL B30M	D.31
1562920000	HSS-HF 9.5-19.1 EL B30M	D.31
1562930000	HSS-HF 12.7-25.4 EL B30M	D.31
1562940000	HSS-HF 1.2-2.4 EL G30M	D.31
1562950000	HSS-HF 1.6-3.2 EL G30M	D.31
1562970000	HSS-HF 2.4-4.8 EL G30M	D.31
1562980000	HSS-HF 3.2-6.4 EL G30M	D.31
1562990000	HSS-HF 4.8-9.5 EL G30M	D.31
1563020000	HSS-HF 6.4-12.7 EL G30M	D.31
1563030000	HSS-HF 9.5-19.1 EL G30M	D.31
1563040000	HSS-HF 12.7-25.4 EL G30M	D.31
1568241055	CLJ C 02-3 GE/SW A CD	E.14
1568241056	CLJ C 02-3 GE/SW B CD	E.14
1568241057	CLJ C 02-3 GE/SW C CD	E.14
1568241058	CLJ C 02-3 GE/NE CD	E.7
1568241502	CLJ C 02-3 GE/SW 0 CD	E.13
1568241503	CLJ C 02-3 SW/WS 0 CD	E.13
1568241505	CLJ C 02-3 GE/SW 1 CD	E.13
1568241506	CLJ C 02-3 BR/WS 1 CD	E.13
1568241508	CLJ C 02-3 GE/SW 2 CD	E.13
1568241509	CLJ C 02-3 RT/WS 2 CD	E.13
1568241511	CLJ C 02-3 GE/SW 3 CD	E.13
1568241512	CLJ C 02-3 OR/SW 3 CD	E.13
1568241514	CLJ C 02-3 GE/SW 4 CD	E.13
1568241517	CLJ C 02-3 GE/SW 5 CD	E.13
1568241518	CLJ C 02-3 GN/WS 5 CD	E.13
1568241520	CLJ C 02-3 GE/SW 6 CD	E.13
1568241521	CLJ C 02-3 BL/WS 6 CD	E.13
1568241523	CLJ C 02-3 GE/SW 7 CD	E.13
1568241524	CLJ C 02-3 VI/WS 7 CD	E.13
1568241526	CLJ C 02-3 GE/SW 8 CD	E.13
1568241527	CLJ C 02-3 GR/SW 8 CD	E.13
1568241529	CLJ C 02-3 GE/SW 9 CD	E.13
1568241530	CLJ C 02-3 WS/SW 9 CD	E.13
1568241637	CLJ C 02-3 GE/SW A CD	E.14
1568241639	CLJ C 02-3 GE/SW B CD	E.14
1568241641	CLJ C 02-3 GE/SW C CD	E.14
1568241643	CLJ C 02-3 GE/SW D CD	E.14
1568241645	CLJ C 02-3 GE/SW E CD	E.14
1568241647	CLJ C 02-3 GE/SW F CD	E.14
1568241649	CLJ C 02-3 GE/SW G CD	E.14
1568241651	CLJ C 02-3 GE/SW H CD	E.14
1568241653	CLJ C 02-3 GE/SW I CD	E.14
1568241655	CLJ C 02-3 GE/SW J CD	E.14
1568241657	CLJ C 02-3 GE/SW K CD	E.14
1568241659	CLJ C 02-3 GE/SW L CD	E.14
1568241661	CLJ C 02-3 GE/SW M CD	E.14
1568241663	CLJ C 02-3 GE/SW N CD	E.14
1568241665	CLJ C 02-3 GE/SW O CD	E.14
1568241667	CLJ C 02-3 GE/SW P CD	E.14
1568241669	CLJ C 02-3 GE/SW Q CD	E.14
1568241671	CLJ C 02-3 GE/SW R CD	E.14
1568241673	CLJ C 02-3 GE/SW S CD	E.14

Order No.	Type	Page
1568241676	CLJ C 02-3 GE/SW T CD	E.14
1568241679	CLJ C 02-3 GE/SW U CD	E.14
1568241681	CLJ C 02-3 GE/SW V CD	E.14
1568241683	CLJ C 02-3 GE/SW W CD	E.14
1568241686	CLJ C 02-3 GE/SW X CD	E.14
1568241698	CLJ C 02-3 GE/SW Y CD	E.14
1568241698	CLJ C 02-3 GE/SW Z CD	E.14
1568241726	CLJ C 02-6 GE/SW A1 CD	E.15
1568241727	CLJ C 02-6 GE/SW A2 CD	E.15
1568241728	CLJ C 02-6 GE/SW L1 CD	E.15
1568241729	CLJ C 02-6 GE/SW L2 CD	E.15
1568241730	CLJ C 02-6 GE/SW L3 CD	E.15
1568241734	CLJ C 02-9 GE/SW PEN CD	E.15
1568241735	CLJ C 02-3 GE/SW A CD	E.12
1568241736	CLJ C 02-3 GE/SW B CD	E.12
1568241737	CLJ C 02-3 RT/WS + CD	E.14
1568241738	CLJ C 02-3 GE/SW + CD	E.14
1568241740	CLJ C 02-3 GE/SW - CD	E.14
1568241741	CLJ C 02-3 BL/WS - CD	E.14
1568241742	CLJ C 02-3 GE/SW / CD	E.14
1568241746	CLJ C 02-3 GE/SW ET CD	E.14
1568241747	CLJ C 02-3 GE/SW PET. CD	E.14
1568241748	CLJ C 02-3 GE/SW 8 CD	E.14
1568241750	CLJ C 02-3 GE/SW : CD	E.14
1568241751	CLJ C 02-3 GE/SW = CD	E.14
1568241752	CLJ C 02-3 GE/SW AC CD	E.14
1568249999	CLJ C 02-3 SDR CD	E.9
1568250001	CLJ C 1-3 WS/SW 1 CD	E.18
1568250002	CLJ C 1-3 WS/SW 2 CD	E.18
1568250003	CLJ C 1-3 WS/SW 3 CD	E.18
1568250004	CLJ C 1-3 WS/SW 4 CD	E.18
1568250005	CLJ C 1-3 WS/SW 5 CD	E.18
1568250006	CLJ C 1-3 WS/SW 6 CD	E.18
1568250007	CLJ C 1-3 WS/SW 7 CD	E.18
1568250008	CLJ C 1-3 WS/SW 8 CD	E.18
1568251000	CLJ C 1-3 WS/SW 0 CD	E.19
1568251021	CLJ C 1-3 WS/SW A CD	E.19
1568251022	CLJ C 1-3 WS/SW B CD	E.19
1568251023	CLJ C 1-3 WS/SW C CD	E.19
1568251024	CLJ C 1-3 WS/SW D CD	E.19
1568251025	CLJ C 1-3 WS/SW E CD	E.19
1568251026	CLJ C 1-3 WS/SW F CD	E.19
1568251027	CLJ C 1-3 WS/SW G CD	E.19
1568251028	CLJ C 1-3 WS/SW H CD	E.19
1568251029	CLJ C 1-3 WS/SW I CD	E.19
1568251030	CLJ C 1-3 WS/SW J CD	E.19
1568251031	CLJ C 1-3 WS/SW K CD	E.19
1568251032	CLJ C 1-3 WS/SW L CD	E.19
1568251033	CLJ C 1-3 WS/SW M CD	E.19
1568251034	CLJ C 1-3 WS/SW N CD	E.19
1568251035	CLJ C 1-3 WS/SW O CD	E.19
1568251036	CLJ C 1-3 WS/SW P CD	E.19
1568251037	CLJ C 1-3 WS/SW Q CD	E.19
1568251038	CLJ C 1-3 WS/SW R CD	E.19
1568251039	CLJ C 1-3 WS/SW S CD	E.19
1568251040	CLJ C 1-3 WS/SW T CD	E.19
1568251041	CLJ C 1-3 WS/SW U CD	E.19
1568251042	CLJ C 1-3 WS/SW V CD	E.19
1568251043	CLJ C 1-3 WS/SW W CD	E.19
1568251044	CLJ C 1-3 WS/NE CD	E.8
1568251045	CLJ C 1-3 WS/SW Y CD	E.19
1568251046	CLJ C 1-3 WS/SW Z CD	E.19
1568251047	CLJ C 1-3 WS/WS - CD	E.20
1568251048	CLJ C 1-3 WS/SW + CD	E.20
1568251049	CLJ C 1-3 WS/SW - CD	E.20
1568251050	CLJ C 1-3 WS/SW / CD	E.20
1568251051	CLJ C 1-3 WS/SW : CD	E.20
1568251052	CLJ	

Order No.	Type	Page
1568261746	CLI C 2.4 GE/SW ET CD	E.28
1568261747	CLI C 2.4 GE/SW PET. CD	E.28
1568261748	CLI C 2.4 GE/SW CD	E.28
1568261750	CLI C 2.4 GE/SW : CD	E.28
1568261751	CLI C 2.4 GE/SW - CD	E.28
1568261752	CLI C 2.4 GE/SW AC CD	E.28
1568269999	CLI C 2.4 SDR CD	E.10
1568300001	CLI M 2.4 GE NE CD	E.45
1568300002	CLI M 2.4 WS/SW 2 CD	E.49
1568300003	CLI M 2.4 WS/SW 3 CD	E.49
1568300004	CLI M 2.4 GE/SW 4 CD	E.49
1568300005	CLI M 2.4 WS/SW 5 CD	E.49
1568300006	CLI M 2.4 WS/SW 6 CD	E.49
1568300007	CLI M 2.4 WS/SW 7 CD	E.49
1568300008	CLI M 2.4 WS/SW 8 CD	E.49
1568301000	CLI M 2.4 WS/SW 0 CD	E.49
1568301502	CLI M 2.4 GE/SW 0 CD	E.49
1568301503	CLI M 2.4 SW/WS 0 CD	E.49
1568301505	CLI M 2.4 GE/SW 1 CD	E.49
1568301506	CLI M 2.4 BR/WS 1 CD	E.48
1568301508	CLI M 2.4 GE/SW 2 CD	E.49
1568301509	CLI M 2.4 RT/WS 2 CD	E.49
1568301511	CLI M 2.4 GE/SW 3 CD	E.49
1568301512	CLI M 2.4 OR/SW 3 CD	E.48
1568301514	CLI M 2.4 GE/SW 4 CD	E.48
1568301514	CLI M 2.4 GE/SW 4 CD	E.49
1568301517	CLI M 2.4 GE/SW 5 CD	E.48
1568301518	CLI M 2.4 GN/WS 5 CD	E.49
1568301520	CLI M 2.4 GE/SW 6 CD	E.48
1568301521	CLI M 2.4 BL/WS 6 CD	E.48
1568301523	CLI M 2.4 GE/SW 7 CD	E.49
1568301524	CLI M 2.4 VI/WS 7 CD	E.48
1568301526	CLI M 2.4 GE/SW 8 CD	E.49
1568301527	CLI M 2.4 GR/SW 8 CD	E.48
1568301529	CLI M 2.4 GE/SW 9 CD	E.49
1568301530	CLI M 2.4 WS/SW 9 CD	E.48
1568301530	CLI M 2.4 WS/SW 9 CD	E.49
1568301637	CLI M 2.4 GE/SW A CD	E.49
1568301639	CLI M 2.4 GE/SW B CD	E.49
1568301641	CLI M 2.4 GE/SW C CD	E.49
1568301643	CLI M 2.4 GE/SW D CD	E.49
1568301645	CLI M 2.4 GE/SW E CD	E.49
1568301647	CLI M 2.4 GE/SW F CD	E.49
1568301649	CLI M 2.4 GE/SW G CD	E.49
1568301651	CLI M 2.4 GE/SW H CD	E.49
1568301653	CLI M 2.4 GE/SW I CD	E.49
1568301655	CLI M 2.4 GE/SW J CD	E.49
1568301657	CLI M 2.4 GE/SW K CD	E.49
1568301659	CLI M 2.4 GE/SW L CD	E.49
1568301661	CLI M 2.4 GE/SW M CD	E.49
1568301663	CLI M 2.4 GE/SW N CD	E.49
1568301665	CLI M 2.4 GE/SW O CD	E.49
1568301667	CLI M 2.4 GE/SW P CD	E.49
1568301669	CLI M 2.4 GE/SW Q CD	E.49
1568301671	CLI M 2.4 GE/SW R CD	E.49
1568301673	CLI M 2.4 GE/SW S CD	E.49
1568301676	CLI M 2.4 GE/SW T CD	E.49
1568301679	CLI M 2.4 GE/SW U CD	E.49
1568301681	CLI M 2.4 GE/SW V CD	E.49
1568301683	CLI M 2.4 GE/SW W CD	E.49
1568301687	CLI M 2.4 GE/SW X CD	E.49
1568301694	CLI M 2.4 GE/SW A CD	E.48
1568301695	CLI M 2.4 GE/SW 0 CD	E.48
1568301696	CLI M 2.4 GE/SW Y CD	E.49
1568301697	CLI M 2.4 WS/SW 1 CD	E.49
1568301698	CLI M 2.4 GE/SW 2 CD	E.49
1568301699	CLI M 2.4 GE/SW A CD	E.48
1568301735	CLI M 2.4 GE/SW A CD	E.48
1568301736	CLI M 2.4 GE/SW B CD	E.48
1568301738	CLI M 2.4 GE/SW - CD	E.48
1568301740	CLI M 2.4 GE/SW - CD	E.48
1568301741	CLI M 2.4 BL/WS - CD	E.48
1568301742	CLI M 2.4 GE/SW / CD	E.48
1568301746	CLI M 2.4 GE/SW ET CD	E.48
1568301747	CLI M 2.4 GE/SW PET. CD	E.48
1568301748	CLI M 2.4 GE/SW CD	E.48
1568301750	CLI M 2.4 GE/SW : CD	E.48
1568301751	CLI M 2.4 GE/SW - CD	E.48
1568301752	CLI M 2.4 GE/SW AC CD	E.48
1568309999	CLI M 2.4 SDR CD	E.46

## 1570000000

1579500000	CLI M 2:250 SDR SG	E.45
------------	--------------------	------

## 1600000000

1600740000	CLI F 1:20 WS/GE	F.13
1603290000	CC-H 85/54 SW	C.164
1607710000	ESD 5 DIN A4 WS	F.18
1607710000	ESD 5 DIN A4 WS	F.7
1607720000	ESD 7 DIN A4 WS	F.17
1607720000	ESD 7 DIN A4 WS	F.4
1607720000	ESD 7 DIN A4 WS	F.5
1607720000	ESD 7 DIN A4 WS	F.8
1609801044	DEK 5/5 MC NE WS	C.28
1609801044	DEK 5/5 MC NE WS	F.22
1609801044	DEK 5/5 MC NE WS	F.4
1609801044	DEK 5/5 MC NE WS	F.5

Order No.	Type	Page
1609801044	DEK 5/5 MC NE WS	F.6
1609801044	DEK 5/5 MC NE WS	F.8
1609801686	DEK 5/5 MC NE RT	C.28
1609801687	DEK 5/5 MC NE GE	C.28
1609801688	DEK 5/5 MC NE GN	C.28
1609801691	DEK 5/5 MC NE GR	C.28
1609801693	DEK 5/5 MC NE BL	C.28
1609810000	DEK 5/5 MC SDR	C.28
1609820000	DEK 5/6 MC NE WS	C.29
1609830000	DEK 5/6 MC SDR	C.29
1609840000	DEK 5/6.5 MC NE WS	C.30
1609850000	DEK 5/6.5 MC SDR	C.30
1609860000	WS 12/5 MC NE WS	C.39
1609860000	WS 12/5 MC NE WS	F.4
1609860000	WS 12/5 MC NE WS	F.5
1609870000	WS 12/5 MC SDR	C.39
1609880000	WS 15/5 MC NE WS	C.40
1609890000	WS 15/5 MC SDR	C.40
1609900000	WS 12/6 MC NE WS	C.43
1609910000	WS 12/6 MC SDR	C.43
1609920000	WS 12/6.5 MC NE WS	C.44
1609930000	WS 12/6.5 MC SDR	C.44
1609940000	ESG 9/20 MC NE WS	C.139
1609950000	ESG 9/20 MC SDR	C.139
1609981044	TMH 15 MC NE WS	C.113
1609981044	TMH 15 MC NE WS	F.12
1609981044	TMH 15 MC NE WS	F.14
1609981686	TMH 15 MC NE RT	C.113
1609981687	TMH 15 MC NE GE	C.113
1609981693	TMH 15 MC NE BL	C.113
1609990000	TMH 15 MC SDR	C.113

## 1610000000

1610000000	ZS 10/5 MC NE WS	C.51
1610010000	ZS 10/5 MC SDR	C.51
1610020000	ZS 12/6 MC NE WS	C.52
1610030000	ZS 12/6 MC SDR	C.52
1610700000	WK M 18/43	C.100
1610700000	WK M 18/43	C.115
1610700000	WK M 18/43	F.18
1611930000	ZGB 30	F.5

## 1620000000

1629900000	KSW 2.5 &lt; 50MM SDR	E.61
1629910000	KSW 4 &lt; 50MM SDR	E.61
1629920000	KSW 2.5 &lt; 100MM SONDDR.	E.61
1629930000	KSW 4 &lt; 100MM SDR	E.61
1629940000	KSW 2.5 &lt; 150MM SONDDR.	E.61
1629950000	KSW 4 &lt; 150MM SONDDR.	E.61

## 1630000000

1630100001	KSW 2.5 8/5/08 1-8	E.61
1630100009	KSW 2.5 8/5/08 9-16	E.61
1630150001	KSW 4 16/3.5 1-16	E.61
1630160001	KSW 4 16/5/08 1-16	E.61
1630160017	KSW 4 16/5/08 17-32	E.61
1630180001	KSW 4 24/5/08 1-24	E.61
1630200001	KSW 4 8/5/08 1-8	E.61
1631350000	ESD 5 DIN A4 GE	F.18
1631350000	ESD 5 DIN A4 GE	F.7
1631640001	CC-H 85/54 SW	C.164
1631640002	CC-H 85/54 GR	C.164
1631640003	CC-H 85/54 BG	C.164
1631910000	WK M 8/30	C.115
1631910000	WK M 8/30	C.99
1631910000	WK M 8/30	F.17
1631920000	ESD 5 S DIN A4 WS	F.13
1631920000	ESD 5 S DIN A4 WS	F.7
1631930000	SCHT 5 S	C.99
1631930000	SCHT 5 S	F.7
1631940000	STR 5 S F.SCHT 5 S	F.7
1634780000	ESD 7 DIN A4 GE	F.17
1634780000	ESD 7 DIN A4 GE	F.4
1634780000	ESD 7 DIN A4 GE	F.5
1634780000	ESD 7 DIN A4 GE	F.8
1634790000	CLI M 2:400 SDR SG	E.45
1635000000	WS 10/5 MC NE WS	C.37
1635010000	WS 10/5 MC SDR	C.37
1636530000	ZGB 15	F.4

## 1640000000

1640740000	WS 8/5 MC NE WS	C.36
1640740000	WS 8/5 MC NE WS	F.22
1640750000	WS 8/5 MC SDR	C.36
1646630000	ZS 15/5 MC NE WS	C.51
1646640000	ZS 15/5 MC SDR	C.51

## 1650000000

1652220000	ESG 8/19 MC NE WS	C.136
1652230000	ESG 8/19 MC SDR	C.136
1652250001	KSW 2.5 24/3.5 1-24	E.61
1653340001	DEK 8 FW 1:50 TAMPOPR.	E.3
1653340051	DEK 8 FW 5:100 TAMPOPR.	E.3
1653350001	DEK 8 FS 1:50 TAMPOPR.	E.3

Order No.	Type	Page
-----------	------	------

## 1670000000

1670370000	ESD 5 P DIN A4 WS	F.18
1670370000	ESD 5 P DIN A4 WS	F.7
1670380000	ESD 5 P DIN A4 GE	F.18
1670380000	ESD 5 P DIN A4 GE	F.7
1670390000	ESD 7 P DIN A4 WS	F.17
1670390000	ESD 7 P DIN A4 WS	F.4
1670390000	ESD 7 P DIN A4 WS	F.5
1670390000	ESD 7 P DIN A4 WS	F.8
1670400000	ESD 7 P DIN A4 GE	F.17
1670400000	ESD 7 P DIN A4 GE	F.4
1670400000	ESD 7 P DIN A4 GE	F.5
1670400000	ESD 7 P DIN A4 GE	F.8
1674740000	ESG 8/17 MC NE WS	C.133
1674750000	ESG 8/17 MC SDR	C.133
1674760000	ESG 9/17 K MC NE WS	C.138
1674760000	ESG 9/17 K MC NE WS	F.13
1674770000	ESG 9/17 K MC SDR	C.138
1675130001	CC-H 85/27 SW	C.163
1675130002	CC-H 85/27 GR	C.163
1671740000	MF 8/5 MC NE WS	C.58
1671750000	MF 8/5 MC SDR	C.58
1671760000	MF 10/5 MC NE WS	C.58
1671770000	MF 10/5 MC SDR	C.58
1671780000	MF 12/5 MC NE WS	C.59
1671790000	MF 12/5 MC SDR	C.59
1677220000	MF 10/6 MC NE WS	C.61
1677230000	MF 10/6 MC SDR	C.61

## 1680000000

1680411044	TMH 20 MC NE WS	C.113
1680411044	TMH 20 MC NE WS	F.12
1680411044	TMH 20 MC NE WS	F.14
1680411686	TMH 20 MC NE RT	C.113
1680411687	TMH 20 MC NE GE	C.113
1680411693	TMH 20 MC NE BL	C.113
1680420000	TMH 20 MC SDR	C.113
1686110000	TABPACK 14X9	E.59
1686120000	TABPACK 15X6	E.59
1686130000	TABPACK 19X11 M. RAND	E.59
1686140000	TABPACK 21X8	E.59
1686160000	PAGETAB 15/9	E.58
1686170000	PAGETAB 19/11	E.58
1686180000	PAGETAB 20/8	E.58
1686190000	PAGETAB 28/11	E.58
1686200000	PAGETAB 38/11	E.58
1686210000	PAGETAB 56/22	E.58
1686220000	PAGETAB 80/35	E.58
1686360001	LM MT300 15/6 SI	D.46
1686361044	LM MT300 15/6 WS	D.46
1686361687	LM MT300 15/6 GE	D.46
1686380001	LM MT300 20/8 SI	D.46
1686381044	LM MT300 20/8 WS	D.46
1686381687	LM MT300 20/8 GE	D.46
1686390001	LM MT300 25.4/12.7 SI	D.46
1686391044	LM MT300 25.4/12.7 WS	D.46
1686391687	LM MT300 25.4/12.7 GE	D.46
1686400001	LM MT300 26/10 SI	D.46
1686401044	LM MT300 26/10 WS	D.46
1686401687	LM MT300 26/10 GE	D.46
1686420001	LM MT300 56/22 SI	D.46
1686421044	LM MT300 56/22 WS	D.46
1686421687	LM MT300 56/22 GE	D.46
1686430001	LM MT300 60/36 SI	D.46
1686431044	LM MT300 60/36 WS	D.46
1686431687	LM MT300 60/36 GE	D.46
1686440001	LM MT300 210/297 SI	D.46
1686441044	LM MT300 210/297 WS	D.46
1686441687	LM MT300 210/297 GE	D.46
1689490001</		

Order No.	Type	Page
1718411044	TMH 12 MC NE WS	F.11
1718411044	TMH 12 MC NE WS	F.12
1718411044	TMH 12 MC NE WS	F.14
1718411686	TMH 12 MC NE RT	C.113
1718411687	TMH 12 MC NE GE	C.113
1718411693	TMH 12 MC NE BL	C.113
1718420000	TMH 12 MC SDR	C.113
1718431044	TMH 18 MC NE WS	C.113
1718431044	TMH 18 MC NE WS	F.11
1718431044	TMH 18 MC NE WS	F.12
1718431044	TMH 18 MC NE WS	F.13
1718431044	TMH 18 MC NE WS	F.14
1718431686	TMH 18 MC NE RT	C.113
1718431687	TMH 18 MC NE GE	C.113
1718431693	TMH 18 MC NE BL	C.113
1718440000	TMH 18 MC SDR	C.113
1719760000	TM 0/12 HF/HB	F.11
1719770000	TM 0/18 HF/HB	F.11
1719780000	TM 1/12 HF/HB	F.11
1719790000	TM 1/18 HF/HB	F.11
1719800000	TM 2/12 HF/HB	F.11
1719810000	TM 2/18 HF/HB	F.11
1719820000	TM 3/12 HF/HB	F.11
1719830000	TM 3/18 HF/HB	F.11
1719840000	TM 4/12 HF/HB	F.11
1719850000	TM 4/18 HF/HB	F.11
1719860000	TM 5/12 HF/HB	F.11
1719870000	TM 5/18 HF/HB	F.11
1719880000	TM 6/12 HF/HB	F.11
1719890000	TM 6/18 HF/HB	F.11

## 1720000000

1720570000	ETO SM 27/8	C.150
1720580000	ETO SM 27/12,5	C.151
1720590002	ETO SM 27/18 TRANSPAR.	C.151
1720600000	SCHS2 K	C.134
1720600000	SCHS2 K	F.22
1720610000	ESG 8/17 SCHS MC NE WS	C.134
1720610000	ESG 8/17 SCHS MC NE WS	F.11
1720620000	DEK 5/7,5 MC NE WS	C.31
1720630000	CB 200/3,5 NATUR	G.30
1720640000	CB 290/3,5 NATUR	G.30
1720650000	CB 290/3,5 BLACK	G.30
1720660000	CB 200/3,5 BLACK	G.30
1720670000	CB 750/7,5 BLACK	G.30
1720680000	CB 750/7,5 NATUR	G.30
1723540000	CB 160/4,5 NATUR	G.30
1723550000	CB 178/4,8 NATUR	G.30
1723560000	CB 160/4,5 BLACK	G.30
1723570000	CB 178/4,8 BLACK	G.30
1724140001	LM MT300 15/4,6 SI	D.46
1724141044	LM MT300 15/4,6 WS	D.46
1724141687	LM MT300 15/4,6 GE	D.46
1724150001	LM MT300 17/9 SI	D.46
1724151044	LM MT300 17/9 WS	D.46
1724151687	LM MT300 17/9 GE	D.46
1724160001	LM MT300 30/20 SI	D.46
1724161044	LM MT300 30/20 WS	D.46
1724161687	LM MT300 30/20 GE	D.46
1724170001	LM MT300 105/148 SI	D.46
1724171044	LM MT300 105/148 WS	D.46
1724180001	LM MT300 210/148 SI	D.46
1724181687	LM MT300 210/148 GE	D.46
1724760000	ESG 9/17 MC NE WS	C.138
1724790000	TMC 9/20	C.140
1724790000	TMC 9/20	F.13
1727740001	VT SFX 9/24 MC NE WS VO	C.109
1727740004	VT SFX 9/24 MC NE GE VO	C.109
1727770001	VT SFX 10/23 MC NE WS VO	C.109
1727770004	VT SFX 10/23 MC NE GE VO	C.109

## 1730000000

1733650004	CLM 2.4 GE NE MP	E.45
1733651502	CLM 2.4 GE/SW 0 MP	E.47
1733651503	CLM 2.4 SW/WS 0 MP	E.46
1733651505	CLM 2.4 GE/SW 1 MP	E.47
1733651506	CLM 2.4 BR/WS 1 MP	E.46
1733651508	CLM 2.4 GE/SW 2 MP	E.47
1733651509	CLM 2.4 RT/WS 2 MP	E.46
1733651511	CLM 2.4 GE/SW 3 MP	E.47
1733651512	CLM 2.4 OR/SW 3 MP	E.46
1733651514	CLM 2.4 GE/SW 4 MP	E.46
1733651514	CLM 2.4 GE/SW 4 MP	E.47
1733651517	CLM 2.4 GE/SW 5 MP	E.47
1733651518	CLM 2.4 GN/WS 5 MP	E.46
1733651520	CLM 2.4 GE/SW 6 MP	E.47
1733651521	CLM 2.4 BL/WS 6 MP	E.46
1733651523	CLM 2.4 GE/SW 7 MP	E.47
1733651524	CLM 2.4 VI/WS 7 MP	E.46
1733651526	CLM 2.4 GE/SW 8 MP	E.47
1733651527	CLM 2.4 GR/SW 8 MP	E.46
1733651529	CLM 2.4 GE/SW 9 MP	E.47
1733651530	CLM 2.4 WS/SW 9 MP	E.46
1733651637	CLM 2.4 GE/SW 4 MP	E.47
1733651639	CLM 2.4 GE/SW 8 MP	E.47
1733651641	CLM 2.4 GE/SW 8 MP	E.47
1733651643	CLM 2.4 GE/SW 8 MP	E.47

Order No.	Type	Page
1733651645	CLM 2.4 GE/SW E MP	E.47
1733651647	CLM 2.4 GE/SW F MP	E.47
1733651649	CLM 2.4 GE/SW G MP	E.47
1733651651	CLM 2.4 GE/SW H MP	E.47
1733651653	CLM 2.4 GE/SW I MP	E.47
1733651655	CLM 2.4 GE/SW J MP	E.47
1733651657	CLM 2.4 GE/SW K MP	E.47
1733651659	CLM 2.4 GE/SW L MP	E.47
1733651661	CLM 2.4 GE/SW M MP	E.47
1733651663	CLM 2.4 GE/SW N MP	E.47
1733651665	CLM 2.4 GE/SW O MP	E.47
1733651667	CLM 2.4 GE/SW P MP	E.47
1733651669	CLM 2.4 GE/SW Q MP	E.47
1733651671	CLM 2.4 GE/SW R MP	E.47
1733651673	CLM 2.4 GE/SW S MP	E.47
1733651676	CLM 2.4 GE/SW T MP	E.47
1733651679	CLM 2.4 GE/SW U MP	E.47
1733651681	CLM 2.4 GE/SW V MP	E.47
1733651683	CLM 2.4 GE/SW W MP	E.47
1733651687	CLM 2.4 GE/SW X MP	E.47
1733651695	CLM 2.4 GE/SW 0 MP	E.46
1733651696	CLM 2.4 GE/SW Y MP	E.46
1733651697	CLM 2.4 GE/SW Á MP	E.46
1733651698	CLM 2.4 GE/SW Z MP	E.47
1733651699	CLM 2.4 GE/SW À MP	E.46
1733651738	CLM 2.4 GE/SW + MP	E.46
1733651740	CLM 2.4 GE/SW - MP	E.46
1733651742	CLM 2.4 GE/SW / MP	E.46
1733651746	CLM 2.4 GE/SW ET MP	E.46
1733651747	CLM 2.4 GE/SW P.T. MP	E.46
1733651748	CLM 2.4 GE/SW .MP	E.46
1733651750	CLM 2.4 GE/SW :MP	E.46
1733651751	CLM 2.4 GE/SW ~MP	E.46
1733651752	CLM 2.4 GE/SW AC MP	E.46
1736181044	ESG 7/20 SIRIUS MC NE WS	C.131
1736181044	ESG 7/20 SIRIUS MC NE WS	F.17
1736181687	ESG 7/20 SIRIUS MC NE GE	C.131
1736181687	ESG 7/20 SIRIUS MC NE GE	F.17
1736181687	ESG 7/20 SIRIUS MC NE GE	F.23
1736181696	ESG 7/20 SIRIUS MC NE TU	C.131
1736181696	ESG 7/20 SIRIUS MC NE TU	F.17
1736190000	ESG 8/10 ASI MC NE WS	C.131

## 1740000000

1741090000	SYMBOL-P. 25X25X25 B/DR	E.58
1741100000	SYMBOL-P. 50X50X50 B/DR	E.58
1741110000	SYMBOL-P. 75X75X75 B/DR	E.58
1747320001	SFC 1/12 MC NE WS	C.111
1747320002	SFC 1/12 MC NE BL	C.111
1747320003	SFC 1/12 MC NE RT	C.111
1747320004	SFC 1/12 MC NE GE	C.111
1748820000	TMX 18 HF/HB	F.11
1749320001	LM MT300 18/6,5 SI	D.46
1749321044	LM MT300 18/6,5 WS	D.46
1749321687	LM MT300 18/6,5 GE	D.46

## 1750000000

1751561044	THM WO 25/140 GE	D.21
1751561687	THM WO 25/140 GE	D.21
1751750001	THM MT30X 25/12 SI	D.41
1751751044	THM MT30X 25/12 WS	D.41
1751751687	THM MT30X 25/12 GE	D.41
1751760001	THM MT30X 26/10 SI	D.41
1751761044	THM MT30X 26/10 WS	D.41
1751761687	THM MT30X 26/10 GE	D.41
1751770001	THM MT30X 32/9 SI	D.41
1751771044	THM MT30X 32/9 WS	D.41
1751800001	THM MT30X 38/19 SI	D.41
1751801044	THM MT30X 38/19 WS	D.41
1751801687	THM MT30X 38/19 GE	D.41
1751810001	THM MT30X 45/23 SI	D.41
1751811044	THM MT30X 45/23 WS	D.41
1751811687	THM MT30X 45/23 GE	D.41
1751820001	THM MT30X 101/48 SI	D.42
1751821044	THM MT30X 101/48 WS	D.42
1751821687	THM MT30X 101/48 GE	D.42
1751830001	THM MT30X 65/35 SI	D.42
1751830004	THM MT30X 65/35 S/G	D.42
1751831044	THM MT30X 65/35 WS	D.42
1751831687	THM MT30X 65/35 GE	D.42
1752720000	SFC 1/12 MC NE WS	C.111
1752320001	THM MT30X 15/6 SI	D.41
1752321044	THM MT30X 15/6 WS	D.41
1752321687	THM MT30X 15/6 GE	D.41
1752321044	THM MT30X 20/8 WS	D.41
1752321687	THM MT30X 20/8 GE	D.41
17523250001	THM MT30X 18/9 SI	D.41
17523251044	THM MT30X 18/9 WS	D.41
17523251687	THM MT30X 18/9 GE	D.41
17523260001	THM MT30X 30/20 SI	D.41
17523261044	THM MT30X 30/20 WS	D.41
17523261687	THM MT30X 30/20 GE	D.41
17523270001	THM MT30X 18/6 SI	D.41
17523271044	THM MT30X 18/6 WS	D.41
17523271687	THM MT30X 18/6 GE	D.41
1753460000	SCHS4 K	C.131
1753460000	SCHS4 K	F.23

Order No.	Type	Page
1753460000	SCHS4 K	G.29
1753480000	SCHS3 K	C.131
1753480000	SCHS3 K	F.23
1753480000	SCHS3 K	G.29
1753490000	WKM 8/20	F.17
1753500000	ESG 9/17 K MC NE GE	C.138
1755270000	DEK 5/3,5 MC NE WS	C.27
1755270000	DEK 5/3,5 MC NE WS	F.6
1755340000	ESG 8/17 SYS PRO M WS	C.134
1755350000	ESG 8/17 SYS PRO M SDR	C.134
1758320001	SFC 2/12 MC NE WS	C.111
1758320002	SFC 2/12 MC NE BL	C.111
1758320003	SFC 2/12 MC NE RT	C.111
1758320004	SFC 2/12 MC NE GE	C.111
1759871044	LM WO 15/70 WS	D.23

## 1760000000

1760461044	LM MT300 40/6 WS	D.46
1762320001	DEK 5/3,5 MC FSZ 1-10	E.3
1762320011	DEK 5/3,5 MC FSZ 11-20	E.3
1762320021	DEK 5/3,5 MC FSZ 21-30	E.3
1762320031	DEK 5/3,5 MC FSZ 31-40	E.3
1762320041	DEK 5/3,5 MC FSZ 41-50	E.3
1762320051	DEK 5/3,5 MC FSZ 51-60	E.3
1762320061	DEK 5/3,5 MC FSZ 61-70	E.3
1762320071	DEK 5/3,5 MC FSZ 71-80	E.3
1762320081	DEK 5/3,5 MC FSZ 81-90	E.3
1762320091	DEK 5/3,5 MC FSZ 91-100	E.3
1762320101	DEK 5/3,5 MC FSZ 101-110	E.3
1762320111	DEK 5/3,5 MC FSZ 111-120	E.3
1762320121	DEK 5/3,5 MC FSZ 121-130	E.3
1762440000	ADAPTER ALU STI-S	C.13
1762440000	ADAPTER ALU STI-S	C.15
1762960001	THM MT30X 101/74 SI	D.42
1763270000	CLM TM 10-33	F.13
1763280000	CLM TM 20-33	F.13
1763290000	CLM CD-BOX	E.52
1763390000	CLM TM 20-66	F.13
1763480000	SFC 2/12 MC SDR	C.111
1764050000	CLM F 2-17,5 WS/GE	F.13
1764060000	CLM T 02-12	F.12
1764070000	CLM T 02-15	F.12
1764140000	CLM T 02-18	F.12
1764150000	CLM T 02-20	F.12
1764190000	CLM T 1-12	F.12
1764200000	CLM T 1-15	F.12
1764210000	CLM T 1-18	F.12
1764220000	CLM T 1-20	F.12
1764230000	CLM T 2-12	F.12
1764240000	CLM T 2-15	F.12
1764250000	CLM T 2-18	F.12
1764260000	CLM T 2-20	F.12
1764270000	CLM T 3-12	F.12
1764280000	CLM T 3-15	F.12
1764290000	CLM T 3-18	F.12
1764300000	CLM T 3-20	F.12
1766160000	ESG 9/20 MC NE GE	C.139
1766640000	ESG 8/17 SCHS MC SDR	C.134
1766650000	ESG 7/20 SIRIUS MC SDR	C.131
1768730000	DEK 5/3,5 MC SDR	C.27
1768809000	WS 14/5 MC NE WS	C.40
1768838000	LM WO 25,4/57 WS	D.23
1768839000	LM WO 25,4/57 GE	D.23
1768400000	LM WO 25,4/95 WS	D.23
1768430000	LM WO 37,25 GE	D.23
1768540000	PLOTTERPEN 0,25	C.13
1768540000	PLOTTERPEN 0,25	C.15
1768550000	PLOTTERPEN 0,35	C.13
1768550000	PLOTTERPEN 0,35	C.15
1768560000	PLOTTERPEN 0,5	C.13
1768560000	PLOTTERPEN 0,5	C.15
1768570000	PLOTTERPEN 0,18	C.13
1768570000	PLOTTERPEN 0,18	C.15

## 1770000000

1770080000	SF-TOOL-SORTIMENT	C.107
1770090000	THM MT30X 26,5/17,5 SI	D.41
1770470000	ESG 8/10 ASI MC SDR	C.131
1770480000	ESG 9/17 MC SDR	C.138
1770490		

Order No.	Type	Page
1806190000	TM 205/12 VO	F.13
1806200000	TM 206/12 VO	F.13
1806240000	TM 204/15 VO	F.13
1806250000	TM 205/15 VO	F.13
1806260000	TM 206/15 VO	F.13
1806300000	TM 204/18 VO	F.13
1806310000	TM 205/18 VO	F.13
1806320000	TM 206/18 VO	F.13
1806360000	TM 204/20 VO	F.13
1806370000	TM 205/20 VO	F.13
1806380000	TM 206/20 VO	F.13

## 1810000000

1812630000	SM 27/8 K MC NE WS	C.150
1812660000	KSW 2.5 EL WS 50M	E.61
1812670000	KSW 4.0 EL WS 50M	E.61
1813130000	SFC 0/12 MC NE WS	C.111
1813150000	SFC 0/12 MC NE RT	C.111
1813160000	SFC 0/12 MC NE GE	C.111
1813170000	SFC 0/12 MC NE BL	C.111
1813180000	SFC 0/12 MC SDR	C.111
1813190000	SFC 0/21 MC NE WS	C.111
1813200000	SFC 0/21 MC NE RT	C.111
1813210000	SFC 0/21 MC NE GE	C.111
1813220000	SFC 0/21 MC NE BL	C.111
1813230000	SFC 0/21 MC SDR	C.111
1813240000	SFC 0/30 MC NE WS	C.111
1813250000	SFC 0/30 MC NE RT	C.111
1813260000	SFC 0/30 MC NE GE	C.111
1813270000	SFC 0/30 MC NE BL	C.111
1813280000	SFC 0/30 MC SDR	C.111
1816240000	MF-W 5/5 MINI MC NE WS	C.77
1816250000	MF 5/5 MC NE WS	C.57
1816260000	MF 5/6 MC NE WS	C.61
1816270000	MF-W 9/5 MC NE WS	C.68
1816280000	MF-W 9/5 MC NE WS	C.68
1816290000	MF-W 9/6 MC NE WS	C.70
1816310000	MF-W 5/5 MINI MC SDR	C.71
1816320000	MF 5/5 MC SDR	C.57
1816330000	MF 5/6 MC SDR	C.61
1816340000	MF-W 9/5 MC SDR	C.68
1816350000	MF-W 9/5 MC SDR	C.68
1816360000	MF-W 9/6 MC SDR	C.70
1818400000	WS 10/6 M MC NE WS	C.42
1818410000	WS 10/6 M MC SDR	C.42

## 1820000000

1821020000	ET S7-300-GE-A4-1	D.45
1821030000	ET S7-400-GE-A4-2	D.45
1821040000	ET S7-400-GE-A4-1	D.45
1828450000	WS 10/6 MC NE WS	C.41
1828460000	WS 10/6 MC SDR	C.41

## 1830000000

1835820000	LM MT300 17/6 GE	D.46
1835830000	LM MT300 19/6.3 GE	D.46

## 1840000000

1847640000	ET S7-400-GE-A4-3	D.45
1847650000	ET S7-300-GE-A4-2	D.45

## 1850000000

1852360000	SFX 10/23 MC NE GE V2	C.109
1852370000	SFX 10/23 MC NE RT V2	C.109
1852380000	SFX 10/23 MC SDR V2	C.109
1852390000	SFX 10/23 MC NE WS V2	C.109
1852400000	SFX 10/23 MC NE BL V2	C.109
1852410000	SFX 14/23 MC NE GE V2	C.109
1852420000	SFX 14/23 MC NE RT V2	C.109
1852430000	SFX 14/23 MC SDR V2	C.109
1852440000	SFX 14/23 MC NE WS V2	C.109
1852450000	SFX 14/23 MC NE BL V2	C.109
1852460000	SFX 9/24 MC NE GE V2	C.109
1852470000	SFX 9/24 MC NE RT V2	C.109
1852480000	SFX 9/24 MC SDR V2	C.109
1852490000	SFX 9/24 MC NE WS V2	C.109
1852500000	SFX 9/24 MC NE BL V2	C.109
1852520000	THM MT30X 16/7 GE	D.41
1852540000	THM MT30X 57/27 SI	D.41
1852980000	WS 14/5 MC SDR	C.40
1854090000	WS 10/15 MC NE WS	C.47
1854100000	WS 10/15 MC SDR	C.47
1854490000	DEK 5/5 PLUS MC NE WS	C.28
1854500000	DEK 5/5 PLUS MC SDR	C.28
1854510000	MF 10/5 CABUR MC NE WS	C.59
1854520000	MF 12/5 CABUR MC NE WS	C.60
1856630000	THM WO 12/18 GE	D.21
1856640000	THM WO 12/18 WS	D.21
1856650000	THM MT30X 17/9 GE	D.41
1856700000	ESG 10/17 MC NE WS	C.141
1856710000	ESG 10/17 MC SDR	C.141
1856720000	ESG 9/20 UNI MC NE WS	C.140
1856730000	ESG 9/20 UNI MC SDR	C.140
1856740000	DEK 5/8 MC NE WS	C.32

Order No.	Type	Page
1856750000	DEK 5/8 MC SDR	C.32
1856760000	MF 10/10 MC NE WS	C.63
1856770000	MF 10/10 MC SDR	C.63
1856780000	MFF 10/6 MC NE WS	C.65
1856790000	MFF 10/6 MC SDR	C.65
1857440000	ESG 9/11 K MC NE WS	C.137
1857450000	ESG 9/11 K MC SDR	C.137
1859410000	CBFP 43.5/10 BLACK	G.33

## 1860000000

1860120000	SFX 11/60 MC NE WS	C.109
1860140000	SFX 11/60 MC SDR	C.109
1860150000	SFX 11/60 MC NE GE	C.109
1861510000	LM MT300 27/8 GE	D.46
1862350000	THM MT30X 38.1/31.8 SI	D.41
1865440000	ET S7-12/50-TU-A4	D.45
1865450000	ET S7-300-TU-A4-1	0.45
1865460000	ET S7-300-TU-A4-2	0.45
1865470000	ET S7-400-TU-A4-1	0.45
1865480000	ET S7-400-TU-A4-2	0.45
1865490000	ET S7-400-TU-A4-3	0.45
1866680000	TMX 30 VO	F.13
1866690000	ESG 9/20 MC NE TK	C.139
1868430000	MF 10/8 MC SDR	C.62
1868440000	MF 10/8 MC NE WS	C.62
1868811150	CLJ C 1-6 GE/SW X1 CD	E.25
1868811151	CLJ C 1-6 GE/SW X2 CD	E.25
1868811522	CLJ C 1-6 GE/SW O1 CD	E.23
1868811523	CLJ C 1-6 GE/SW O2 CD	E.23
1868811524	CLJ C 1-6 GE/SW O3 CD	E.23
1868811525	CLJ C 1-6 GE/SW O4 CD	E.23
1868811526	CLJ C 1-6 GE/SW O5 CD	E.23
1868811527	CLJ C 1-6 GE/SW O6 CD	E.23
1868811528	CLJ C 1-6 GE/SW O7 CD	E.23
1868811529	CLJ C 1-6 GE/SW O8 CD	E.23
1868811530	CLJ C 1-6 GE/SW O9 CD	E.23
1868811531	CLJ C 1-6 GE/SW 10 CD	E.23
1868811532	CLJ C 1-6 GE/SW 11 CD	E.23
1868811533	CLJ C 1-6 GE/SW 12 CD	E.23
1868811534	CLJ C 1-6 GE/SW 13 CD	E.23
1868811535	CLJ C 1-6 GE/SW 14 CD	E.23
1868811536	CLJ C 1-6 GE/SW 15 CD	E.23
1868811537	CLJ C 1-6 GE/SW 16 CD	E.23
1868811538	CLJ C 1-6 GE/SW 17 CD	E.23
1868811539	CLJ C 1-6 GE/SW 18 CD	E.23
1868811540	CLJ C 1-6 GE/SW 19 CD	E.23
1868811541	CLJ C 1-6 GE/SW 20 CD	E.23
1868811542	CLJ C 1-6 GE/SW 21 CD	E.23
1868811543	CLJ C 1-6 GE/SW 22 CD	E.23
1868811544	CLJ C 1-6 GE/SW 23 CD	E.23
1868811545	CLJ C 1-6 GE/SW 24 CD	E.23
1868811546	CLJ C 1-6 GE/SW 25 CD	E.23
1868811547	CLJ C 1-6 GE/SW 26 CD	E.23
1868811548	CLJ C 1-6 GE/SW 27 CD	E.23
1868811549	CLJ C 1-6 GE/SW 28 CD	E.23
1868811550	CLJ C 1-6 GE/SW 29 CD	E.23
1868811551	CLJ C 1-6 GE/SW 30 CD	E.23
1868811552	CLJ C 1-6 GE/SW 31 CD	E.23
1868811553	CLJ C 1-6 GE/SW 32 CD	E.23
1868811554	CLJ C 1-6 GE/SW 33 CD	E.23
1868811555	CLJ C 1-6 GE/SW 34 CD	E.23
1868811556	CLJ C 1-6 GE/SW 35 CD	E.23
1868811557	CLJ C 1-6 GE/SW 36 CD	E.23
1868811558	CLJ C 1-6 GE/SW 37 CD	E.23
1868811559	CLJ C 1-6 GE/SW 38 CD	E.23
1868811560	CLJ C 1-6 GE/SW 39 CD	E.23
1868811561	CLJ C 1-6 GE/SW 40 CD	E.23
1868811562	CLJ C 1-6 GE/SW 41 CD	E.23
1868811563	CLJ C 1-6 GE/SW 42 CD	E.23
1868811564	CLJ C 1-6 GE/SW 43 CD	E.23
1868811565	CLJ C 1-6 GE/SW 44 CD	E.23
1868811566	CLJ C 1-6 GE/SW 45 CD	E.23
1868811567	CLJ C 1-6 GE/SW 46 CD	E.23
1868811568	CLJ C 1-6 GE/SW 47 CD	E.23
1868811569	CLJ C 1-6 GE/SW 48 CD	E.23
1868811570	CLJ C 1-6 GE/SW 49 CD	E.23
1868811571	CLJ C 1-6 GE/SW 50 CD	E.23
1868811572	CLJ C 1-6 GE/SW 51 CD	E.24
1868811573	CLJ C 1-6 GE/SW 52 CD	E.24
1868811574	CLJ C 1-6 GE/SW 53 CD	E.24
1868811575	CLJ C 1-6 GE/SW 54 CD	E.24
1868811576	CLJ C 1-6 GE/SW 55 CD	E.24
1868811577	CLJ C 1-6 GE/SW 56 CD	E.24
1868811578	CLJ C 1-6 GE/SW 57 CD	E.24
1868811579	CLJ C 1-6 GE/SW 58 CD	E.24
1868811580	CLJ C 1-6 GE/SW 59 CD	E.24
1868811581	CLJ C 1-6 GE/SW 60 CD	E.24
1868811582	CLJ C 1-6 GE/SW 61 CD	E.24
1868811583	CLJ C 1-6 GE/SW 62 CD	E.24
1868811584	CLJ C 1-6 GE/SW 63 CD	E.24
1868811585	CLJ C 1-6 GE/SW 64 CD	E.24
1868811586	CLJ C 1-6 GE/SW 65 CD	E.24
1868811587	CLJ C 1-6 GE/SW 66 CD	E.24
1868811588	CLJ C 1-6 GE/SW 67 CD	E.24
1868811589	CLJ C 1-6 GE/SW 68 CD	E.24
1868811590	CLJ C 1-6 GE/SW 69 CD	E.24
1868811591	CLJ C 1-6 GE/SW 70 CD	E.24
1868811592	CLJ C 1-6 GE/SW 71 CD	E.24

Order No.	Type	Page
1868811593	CLJ C 1-6 GE/SW 72 CD	E.24
1868811594	CLJ C 1-6 GE/SW 73 CD	E.24
1868811595	CLJ C 1-6 GE/SW 74 CD	E.24
1868811596	CLJ C 1-6 GE/SW 75 CD	E.24
1868811597	CLJ C 1-6 GE/SW 76 CD	E.24
1868811598	CLJ C 1-6 GE/SW 77 CD	E.24
1868811599	CLJ C 1-6 GE/SW 78 CD	E.24
1868811600	CLJ C 1-6 GE/SW 79 CD	E.24
1868811601	CLJ C 1-6 GE/SW 80 CD	E.24
1868811602	CLJ C 1-6 GE/SW 81 CD	E.24
1868811603	CLJ C 1-6 GE/SW 82 CD	E.24
1868811604	CLJ C 1-6 GE/SW 83 CD	E.24
1868811605	CLJ C 1-6 GE/SW 84 CD	E.24
1868811606	CLJ C 1-6 GE/SW 85 CD	E.24
1868811607	CLJ C 1-6 GE/SW 86 CD	E.24
1868811608	CLJ C 1-6 GE/SW 87 CD	E.24
1868811609	CLJ C 1-6 GE/SW 88 CD	E.24
1868811610	CLJ C 1-6 GE/SW 89 CD	E.24
1868811611	CLJ C 1-6 GE/SW 90 CD	E.24
1868811612	CLJ C 1-6 GE/SW 91 CD	E.24
1868811613	CLJ C 1-6 GE/SW 92 CD	E.24
1868811614	CLJ C 1-6 GE/SW 93 CD	E.24
1868811615	CLJ C 1-6 GE/SW 94 CD	E.24
1868811616	CLJ C 1-6 GE/SW 95 CD	E.24
1868811617	CLJ C 1-6 GE/SW 96 CD	E.24
1868811618	CLJ C 1-6 GE/SW 97 CD	E.24
1868811619	CLJ C 1-6 GE/SW 98 CD	E.24
1868811620	CLJ C 1-6 GE/SW 99 CD	E.24
1868811687	CLJ C 1-6 GE NE CD	E.8
1868811726	CLJ C 1-6 GE/SW A1 CD	E.25
1868811727	CLJ C 1-6 GE/SW A2 CD	E.25
1868811728	CLJ C 1-6 GE/SW L1 CD	E.25
1868811729	CLJ C 1-6 GE/SW L2 CD	E.25
1868811730	CLJ C 1-6 GE/SW L3 CD	E.25
1868811731	CLJ C 1-6 GE/SW MP CD	E.25
1868811733	CLJ C 1-6 GE/SW PE CD	E.25
1868811734	CLJ C 1-9 GE/SW PEN CD	E.25
1868811735	CLJ C 1-6 GE/SW U1 CD	E.25
1868811736	CLJ C 1-6 GE/SW U2 CD	E.25
1868811737	CLJ C 1-6 GE/SW U3 CD	E.25
1868811738	CLJ C 1-6 GE/SW UN CD	E.25
1868811739	CLJ C 1-6 GE/SW 11 CD	E.25
1868811740	CLJ C 1-6 GE/SW 12 CD	E.25
1868811741	CLJ C 1-6 GE/SW IC CD	E.25
1868819999	CLJ C 1-9 SDR SG	E.10
1869821502	CLJ C 02-3 WS/SW 0 CD	E.13
1869821505	CLJ C 02-3 WS/SW 1 CD	E.13
1869821508	CLJ C 02-3 WS/SW 2 CD	E.13
1869821511	CLJ C 02-3 WS/SW 3 CD	E.13
1869821514	CLJ C 02-3 WS/SW 4 CD	E.13
1869821517	CLJ C 02-3 WS/SW 5 CD	E.13
1869821520	CLJ C 02-3 WS/SW 6 CD	E.13
1869821523	CLJ C 02-3 WS/SW 7 CD	E.13
1869821526	CLJ C 02-3 WS/SW 8 CD	E.13
1869821740	CLJ C 02-3 WS/SW - CD	E.14
1869999999	CLJ C 02-6 SDR CD	E.9

## 1870000000

1871751728	CLJ M 2-6 GE/SW L1 MP	E.50
1871751729	CLJ M 2-6 GE/SW L2 MP	E.50
1871751730	CLJ M 2-6 GE/SW L3 MP	E.50
1871781728	CLJ M 2-6 GE/SW L1 CD	E.50
1871781729	CLJ M 2-6 GE/SW L2 CD	E.50
1871781730	CLJ M 2-6 GE/SW L3 CD	E.50
1871789999	CLJ M 2-6 SDR CD	E.46
1871801687	CLJ C 1-18 GE NE SG	E.8
1871809999	CLJ C 1-18 SDR SG	E.10
1871831687	CLJ C 2-18 GE NE SG	E.8
1871839999	CLJ C 2-18 SDR SG	E.10
1871891728	CLJ C 2-6 GE/SW L1 MP	E.29
1871891729	CLJ C 2-6 GE/SW L2 MP	E.29
1871891730	CLJ C 2-6 GE/SW L3 MP	E.29
1871901728	CLJ C 2-6 GE/SW L1 CD	E.29
1871901729	CLJ C 2-6 GE/SW L2 CD	E.29

Order No.	Type	Page
1889770000	MF-SI 7/5-6.5 MC SDR	C.77
1889780000	MF-SI 7/5-6.5 MC NE WS	C.77
1889790000	MF-SI 10/5-6.5 MC SDR	C.77
1889800000	MF-SI 10/5-6.5 MC NE WS	C.77

## 1890000000

1890460000	ESG 9/20 L MC NE WS	C.139
1890470000	ESG 8/17 L MC NE WS	C.133
1891670000	WSMC 11-15	E.56
1891680000	WSMC 6-10	E.56
1891770000	THM MT30X 25.9/7.1 WS	D.41
1891780000	TM 1/18 TWIN HF/HB	F.11
1891810000	TM 0/18 TWIN HF/HB	F.11
1897570000	ESG 8/11 MC NE WS	C.132
1899230000	CLJ M 2-18 SDR SG	E.45
1899240000	CLJ C 2-9 SDR CD	E.10
1899250000	CLJ M 2-9 SDR CD	E.46
1899260000	CLJ M 2-15 SDR SG	E.45
1899290000	CLJ C 02-9 SDR CD	E.9

## 1900000000

1905490000	M-PRINT PRO	B.4
1905490000	M-PRINT PRO	C.11
1905950000	WS 10/8 PLUS MC NE WS	C.45
1905970000	WS 10/12 MC NE WS	C.46
1906000000	WS 12/8 PLUS MC NE WS	C.45
1906010000	WS 12/8 PLUS MC SDR	C.45
1906030000	WS 10/8 PLUS MC SDR	C.45
1906060000	WS 10/12 MC SDR	C.46
1906110000	SM 27/18 MC NE RT	C.151
1906120000	SM 27/18 K MC NE RT	C.151
1907520000	DEK 5/5 PLUS MC NE GE	C.28
1907530000	MF 4/5.2 MC NE WS	C.60

## 1910000000

1912090000	DEK 5/6 MC NE OR	C.29
1912130000	ESG 8/13.5/43.3 SAI AU	C.132
1912140000	WSMC 16-20	E.56
1912150000	WSMC 21-25	E.56
1912160000	WSMC 26-30	E.56
1912170000	WSMC 1-5	E.56
1912500000	CLJ C 02-24 SDR SG	E.9
1912510000	CLJ C 02-27 SDR SG	E.9
1912550000	CLJ C 02-3 SDR SG	E.9
1912580000	CLJ C 02-30 SDR SG	E.9
1912590000	CLJ C 02-33 SDR SG	E.9
1912600000	CLJ C 02-36 SDR SG	E.9
1912610000	CLJ C 02-39 SDR SG	E.9
1912640000	CLJ C 1-27 SDR SG	E.10
1912650000	CLJ C 1-3 SDR SG	E.10
1912660000	CLJ C 1-30 SDR SG	E.10
1912670000	CLJ C 1-33 SDR SG	E.10
1912680000	CLJ C 1-39 SDR SG	E.10
1912700000	CLJ C 1-6 SDR SG	E.10
1912710000	CLJ C 2-24 SDR SG	E.10
1912720000	CLJ C 2-27 SDR SG	E.10
1912730000	CLJ C 2-30 SDR SG	E.10
1912740000	CLJ C 2-33 SDR SG	E.10
1912750000	CLJ C 2-36 SDR SG	E.10
1912760000	CLJ C 2-39 SDR SG	E.10
1912770000	CLJ C 3-24 SDR SG	E.11
1912780000	CLJ C 3-27 SDR SG	E.11
1912790000	CLJ C 3-30 SDR SG	E.11
1912800000	CLJ C 3-33 SDR SG	E.11
1912810000	CLJ C 3-36 SDR SG	E.11
1912820000	CLJ C 3-39 SDR SG	E.11
1912830000	CLJ M 2-4 SDR SG	E.45
1912840000	CLJ M 2-6 SDR SG	E.45
1912860000	CLJ M 2-24 SDR SG	E.45
1912870000	CLJ M 2-27 SDR SG	E.45
1912880000	CLJ M 2-30 SDR SG	E.45
1912920000	CLJ M 2-33 SDR SG	E.45
1912950000	CLJ M 2-36 SDR SG	E.45
1912960000	CLJ M 2-39 SDR SG	E.45
1915320000	LM MT300 202/12 GE	D.46
1915340000	SM 27/18 K MC NE GE	C.151
1917420000	WS 10/6 MC M NE GN	C.42
1917430000	WS 10/6 MC M NE GE	C.42
1917440000	WS 10/6 MC M NE RT	C.42
1918470000	SF 0/21 MC SDR V2	C.107
1918480000	SF 0/21 MC NE GE V2	C.107
1918490000	SF 0/21 MC NE RT V2	C.107
1918500000	SF 0/21 MC NE WS V2	C.107
1918510000	SF 0/21 MC NE BL V2	C.107
1918530000	SF 00/21 MC SDR V2	C.107
1918560000	SF 00/21 MC NE GE V2	C.107
1918570000	SF 00/21 MC NE RT V2	C.107
1918580000	SF 00/21 MC NE WS V2	C.107
1918590000	SF 00/21 MC NE BL V2	C.107
1918600000	SF 1/21 MC NE RT V2	C.107
1918610000	SF 1/21 MC NE GE V2	C.107
1918620000	SF 1/21 MC NE BL V2	C.107
1918630000	SF 1/21 MC NE WS V2	C.107
1918640000	SF 1/21 MC SDR V2	C.107
1918650000	SF 2/21 MC SDR V2	C.107
1918660000	SF 2/21 MC NE GE V2	C.107

Order No.	Type	Page
1918670000	SF 2/21 MC NE RT V2	C.107
1918690000	SF 2/21 MC NE WS V2	C.107
1918700000	SF 2/21 MC NE BL V2	C.107
1918880000	SF 3/21 MC SDR V2	C.107
1918890000	SF 3/21 MC NE GE V2	C.107
1918900000	SF 3/21 MC NE RT V2	C.107
1918910000	SF 3/21 MC NE WS V2	C.107
1918920000	SF 3/21 MC NE BL V2	C.107
1918990000	SF 4.5/21 MC SDR V2	C.107
1919000000	SF 4.5/21 MC NE GE V2	C.107
1919010000	SF 4.5/21 MC NE RT V2	C.107
1919020000	SF 4.5/21 MC NE WS V2	C.107
1919030000	SF 4.5/21 MC NE BL V2	C.107
1919050000	SF 4/21 MC SDR V2	C.107
1919060000	SF 4/21 MC NE GE V2	C.107
1919070000	SF 4/21 MC NE RT V2	C.107
1919080000	SF 4/21 MC NE WS V2	C.107
1919090000	SF 4/21 MC NE BL V2	C.107
1919110000	SF 5/21 MC SDR V2	C.107
1919120000	SF 5/21 MC NE GE V2	C.107
1919130000	SF 5/21 MC NE RT V2	C.107
1919140000	SF 5/21 MC NE WS V2	C.107
1919150000	SF 5/21 MC NE BL V2	C.107
1919160000	SF 6/21 MC SDR V2	C.107
1919170000	SF 6/21 MC NE GE V2	C.107
1919180000	SF 6/21 MC NE RT V2	C.107
1919190000	SF 6/21 MC NE WS V2	C.107
1919200000	SF 6/21 MC NE BL V2	C.107
1919210000	SF 0/12 MC NE GE V2	C.107
1919220000	SF 0/12 MC NE BL V2	C.107
1919230000	SF 0/12 MC NE RT V2	C.107
1919240000	SF 0/12 MC NE WS V2	C.107
1919250000	SF 0/12 MC SDR V2	C.107
1919260000	SF 00/12 MC NE GE V2	C.107
1919270000	SF 00/12 MC NE BL V2	C.107
1919280000	SF 00/12 MC NE RT V2	C.107
1919290000	SF 00/12 MC NE WS V2	C.107
1919300000	SF 00/12 MC SDR V2	C.107
1919320000	SF 1/12 MC NE RT V2	C.107
1919340000	SF 1/12 MC NE GE V2	C.107
1919360000	SF 1/12 MC NE BL V2	C.107
1919390000	SF 1/12 MC NE WS V2	C.107
1919420000	SF 1/12 MC SDR V2	C.107
1919460000	SF 2/12 MC NE RT V2	C.107
1919470000	SF 2/12 MC NE GE V2	C.107
1919480000	SF 2/12 MC NE BL V2	C.107
1919490000	SF 2/12 MC NE WS V2	C.107
1919500000	SF 2/12 MC SDR V2	C.107
1919510000	SF 3/12 MC SDR V2	C.107
1919520000	SF 3/12 MC NE GE V2	C.107
1919530000	SF 3/12 MC NE RT V2	C.107
1919540000	SF 3/12 MC NE WS V2	C.107
1919550000	SF 3/12 MC NE BL V2	C.107
1919570000	SF 4/12 MC NE RT V2	C.107
1919580000	SF 4/12 MC NE GE V2	C.107
1919590000	SF 4/12 MC NE BL V2	C.107
1919600000	SF 4/12 MC NE WS V2	C.107
1919610000	SF 4/12 MC SDR V2	C.107
1919620000	SF 5/12 MC NE GE V2	C.107
1919630000	SF 5/12 MC NE BL V2	C.107
1919640000	SF 5/12 MC NE RT V2	C.107
1919650000	SF 5/12 MC NE WS V2	C.107
1919660000	SF 5/12 MC SDR V2	C.107
1919870000	ESO 8/20 P DIN A4 WS	F.17
1919880000	ESO 8/20 P DIN A4 GE	F.17
1919890000	ESO 8/20 DIN AA WS	F.17
1919900000	ESO 8/20 DIN AA GE	F.17
1919940000	ESG 5/10 MC NE WS	C.127

1920640000	PLOTTER PEN 0.25 P-INK	C.13
1920640000	PLOTTER PEN 0.25 P-INK	C.15
1920650000	PLOTTER PEN 0.35 P-INK	C.13
1920650000	PLOTTER PEN 0.35 P-INK	C.15
1924260000	MF-W 5/5 MINI MC NE RT	C.71
1924270000	MF-W 5/5 MINI MC NE BL	C.71
1924280000	MF-W 5/5 MINI MC NE GE	C.71
1924290000	MF-W 5/5 MINI MC NE GN	C.71
1924310000	MCP AP SF4-6	C.13
1924310000	MCP AP SF4-6	C.15
1924330000	P-CLEANER	C.13
1924330000	P-CLEANER	C.15
1924340000	P-INK 2.0	C.13
1924340000	P-INK 2.0	C.15
1924360000	MCP AP PLUS	C.13
1924370000	MCP AP LABELS	C.13
1924370000	MCP AP LABELS	C.15
1924930000	WSM SERVICE BOX KOMP.	E.55
1927510000	WS 12/5 PLUS MC NE WS	C.39
1927520000	WS 12/5 PLUS MC SDR	C.39
1927530000	WS 12/6 PLUS MC NE WS	C.44
1927540000	WS 12/6 PLUS MC SDR	C.44

## 1920000000

1920640000	PLOTTER PEN 0.25 P-INK	C.13
1920640000	PLOTTER PEN 0.25 P-INK	C.15
1920650000	PLOTTER PEN 0.35 P-INK	C.13
1920650000	PLOTTER PEN 0.35 P-INK	C.15
1924260000	MF-W 5/5 MINI MC NE RT	C.71
1924270000	MF-W 5/5 MINI MC NE BL	C.71
1924280000	MF-W 5/5 MINI MC NE GE	C.71
1924290000	MF-W 5/5 MINI MC NE GN	C.71
1924310000	MCP AP SF4-6	C.13
1924310000	MCP AP SF4-6	C.15
1924330000	P-CLEANER	C.13
1924330000	P-CLEANER	C.15
1924340000	P-INK 2.0	C.13
1924340000	P-INK 2.0	C.15
1924360000	MCP AP PLUS	C.13
1924370000	MCP AP LABELS	C.13
1924370000	MCP AP LABELS	C.15
1924930000	WSM SERVICE BOX KOMP.	E.55
1927510000	WS 12/5 PLUS MC NE WS	C.39
1927520000	WS 12/5 PLUS MC SDR	C.39
1927530000	WS 12/6 PLUS MC NE WS	C.44
1927540000	WS 12/6 PLUS MC SDR	C.44

## 1930000000

1934190000	THM WO 51/36 WS	D.21
1934330000	CC 30/60 K MC NE SI	C.162
1934370000	CC 30/60 K MC SDR	C.162

Order No.	Type	Page
1934390000	CC 30/60 K MC NE WS	C.162
1934400000	CC 30/60 MC NE SI	C.162
1934410000	CC 30/60 MC SDR	C.162
1934420000	CC 30/60 MC NE WS	C.162
1934430000	CC-H 30/60	C.162
1934440000	ETO CC 30/60 TRANSPAR.	C.162
1934450000	STR CC 30/60 TRANSPARENT	C.162
1935130000	MCP EP	C.15

## 1950000000

1950820000	SF-TOOL 00-6	C.107
1951870000	WS 8/5 PLUS MC NE WS	C.36
1951880000	WS 8/6 PLUS MC NE WS	C.41
1951920000	DEK 5/30 MC NE WS	C.33
1951920000	DEK 5/30 MC NE WS	F.3
1951920000	DEK 5/30 MC NE WS	F.5
1954050000	MF 5/10 MC NE WS	C.63
1954070000	THM MT30X 8/8 WS	D.41
1957340000	MFF 10/6 MC NE GE	C.65

## 1960000000

1963650000	SFX 11/60 MC NE RT	C.109
1964130000	THM MT30X 15/5.1 GE	D.41
1968130000	THM MT30X 17/9 WS	D.41
1968140000	ESG 9/20 L MC SDR	C.139

## 1970000000

1975160000	LM MT300 105/105 SI	D.46
------------	---------------------	------

## 1990000000

1991670000	THM ET S7 1500 GE	D.44
1991680000	THM ET S7 1500 TU	D.44

## 2

Order No.	Type	Page
2006300000	SM 27/18 MM GE	D.36
2006310000	WM 3/12 5.0-8.0 MM GE	D.15
2006320000	SM 27/18 MM SW	D.36
2006330000	WM 0/6 1.0-2.0 MM WS	D.15
2006340000	SM 27/18 MM GR	D.36
2006350000	WM 1/6 2.0-3.5 MM WS	D.15
2006360000	SM 27/18 MM RT	D.36
2006370000	WM 2/6 3.5-5.0 MM WS	D.15
2006380000	SM 27/18 MM GN	D.36
2006390000	WM 3/6 5.0-8.0 MM WS	D.15
2006400000	SM 27/8 MM WS	D.36
2006410000	WM 0/6 1.0-2.0 MM GE	D.15
2006420000	SM 27/8 MM GE	D.36
2006430000	WM 1/6 2.0-3.5 MM GE	D.15
2006440000	SM 27/8 MM SW	D.36
2006450000	WM 2/6 3.5-5.0 MM GE	D.15
2006460000	SM 27/8 MM RT	D.36
2006470000	WM 3/6 5.0-8.0 MM GE	D.15
2006480000	SM 27/8 MM GR	D.36
2006490000	SM 27/8 MM GN	D.36
2006500000	SM 27/12.5 MM WS	D.36
2006510000	SM 27/12.5 MM GE	D.36
2006520000	SM 27/12.5 MM GR	D.36
2006530000	SM 27/12.5 MM SW	D.36
2006540000	SM 27/12.5 MM RT	D.36
2006550000	SM 27/12.5 MM GN	D.36
2006560000	EL 12 MM SI 30M	D.39
2006560000	EL 12 MM SI 30M	G.28
2006570000	EL 12 MM WS 30M	D.39
2006570000	EL 12 MM WS 30M	G.28
2006580000	EL 12 MM GE 30M	D.39
2006580000	EL 12 MM GE 30M	G.28
2006590000	EL 15 MM WS 30M	D.39
2006600000	EL 15 MM GE 30M	D.39
2006610000	EL 15 MM SI 30M	D.39
2006620000	EL 27 MM SI 30M	D.39
2006630000	EL 27 MM WS 30M	D.39
2006640000	EL 27 MM GE 30M	D.39
2006650000	EL 38 MM SI 30M	D.39
2006660000	EL 38 MM WS 30M	D.39
2006670000	EL 38 MM GE 30M	D.39
2006680000	EL 60 MM SI 30M	D.39
2006690000	EL 60 MM WS 30M	D.39
2006700000	EL 60 MM GE 30M	D.39
2006710000	EL 100 MM SI 30M	D.39
2006720000	EL 100 MM WS 30M	D.39
2006730000	EL 100 MM GE 30M	D.39
2007100000	DEK 5/3.5 MM WS	D.11
2007100000	DEK 5/3.5 MM WS	F.6
2007110000	DEK 5/5 MM WS	D.11
2007110000	DEK 5/5 MM WS	F.22
2007110000	DEK 5/5 MM WS	F.5
2007110000	DEK 5/5 MM WS	F.6
2007110000	DEK 5/5 MM WS	F.8
2007120000	DEK 5/6 MM WS	D.11
2007130000	DEK 5/8 MM WS	D.11
2007140000	WS 8/3.5 MM WS	D.11
2007150000	WS 8/5 MM WS	D.11
2007150000	WS 8/5 MM WS	F.22
2007160000	WS 8/6 MM WS	D.11
2007170000	WS 8/8 MM WS	D.11
2007180000	WS 12/3.5 MM WS	D.11
2007180000	WS 12/3.5 MM WS	F.6
2007190000	WS 12/5 MM WS	D.11
2007190000	WS 12/5 MM WS	F.5
2007200000	WS 12/6 MM WS	D.11
2007210000	WS 12/8 MM WS	D.11
2007760000	WS 10/3.5 PLUS MC SDR	C.35
2007770000	WS 10/5 M PLUS MC SDR	C.38
2007780000	WS 10/6 M PLUS MC SDR	C.43
2007790000	DEK 5/3.5 PLUS MC SDR	C.27
2009890000	SFX 10/60 S MC NE WS VO	C.109
2009900000	SFX 10/60 S MC NE GE VO	C.109
2009910000	SFX 9/40 S MC NE WS VO	C.109
2009920000	SFX 9/40 S MC NE GE VO	C.109
2009930000	SFX 9/24 S MC NE WS VO	C.109
2009940000	SFX 9/24 S MC NE GE VO	C.109
2009980000	ELS 6/30 MM WS	D.16
2009980000	ELS 6/30 MM WS	F.17
2009980000	ELS 6/30 MM WS	F.4
2009980000	ELS 6/30 MM WS	F.8

## 2010000000

2010620000	ELS 6/30 MM GE	D.16
2010620000	ELS 6/30 MM GE	F.17
2010620000	ELS 6/30 MM GE	F.4

## 2040000000

2047320000	MF-ABB 12/5 MC NE WS	C.78
2047340000	MF-ABB 12/6 MC NE WS	C.78
2047350000	MF-ABB 12/8 MC NE WS	C.79
2047360000	ESG 15/10 MC NE WS	C.143
2047380000	CC DIA 30 K MC NE WS	C.166
2047390000	CC DIA 30 K MC NE GE	C.166
2047400000	CC DIA 30 K MC NE GR	C.166
2047430000	ESG 9/17.7 K MC NE WS	C.137
2047460000	MF-ABB 12/5 MC SDR	C.78

Order No.	Type	Page
2047510000	MF-ABB 12/6 MC SDR	C.78
2047520000	MF-ABB 12/8 MC SDR	C.79
2047540000	ESG 15/10 MC SDR	C.143
2047550000	ESG 9/17.7 K MC SDR	C.137
2047560000	CC DIA 30 K MC SDR	C.166

## 2060000000

2068020000	PRIMER CC-M	C.117
2068020000	PRIMER CC-M	C.118
2068020000	PRIMER CC-M	C.169
2068020000	PRIMER CC-M	C.170
2068020000	PRIMER CC-M	C.171
2068020000	PRIMER CC-M	C.172
2068020000	PRIMER CC-M	C.173
2068020000	PRIMER CC-M	C.174
2068020000	PRIMER CC-M	C.175
2068020000	PRIMER CC-M	C.176
2068020000	PRIMER CC-M	C.177
2068020000	PRIMER CC-M	C.178
2068020000	PRIMER CC-M	C.179

## 2090000000

2093010000	THM ET S7 1500-13 TU	D.44
2093070000	THM ET S7 1500-13 GE	D.44

## 2120000000

2123070000	CC 85/27 K MC NE SI	C.163
------------	---------------------	-------

## 2430000000

2437470000	HS 0.8-2.4/25 MM W	D.25
2437480000	HS 0.8-2.4/25 MM Y	D.25
2437490000	HS 0.8-2.4/50 MM W	D.26
2437500000	HS 0.8-2.4/50 MM Y	D.26
2437510000	HS 1.0-3.2/25 MM Y	D.25
2437520000	HS 1.0-3.2/25 MM Y	D.25
2437530000	HS 1.0-3.2/50 MM W	D.26
2437540000	HS 1.0-3.2/50 MM Y	D.26
2437550000	HS 1.6-4.8/25 MM W	D.25
2437560000	HS 1.6-4.8/25 MM Y	D.25
2437570000	HS 1.6-4.8/50 MM W	D.26
2437580000	HS 1.6-4.8/50 MM Y	D.26
2437590000	HS 12.7-38.1/25 MM W	D.25
2437600000	HS 12.7-38.1/25 MM Y	D.25
2437610000	HS 12.7-38.1/50 MM W	D.26
2437620000	HS 12.7-38.1/50 MM Y	D.26
2437630000	HS 2.1-6.4/25 MM W	D.25
2437640000	HS 2.1-6.4/25 MM Y	D.25
2437650000	HS 2.1-6.4/50 MM W	D.26
2437660000	HS 2.1-6.4/50 MM Y	D.26
2437670000	HS 3.2-9.5/25 MM W	D.25
2437680000	HS 3.2-9.5/25 MM Y	D.25
2437690000	HS 3.2-9.5/50 MM W	D.26
2437700000	HS 3.2-9.5/50 MM Y	D.26
2437710000	HS 4.2-12.7/25 MM W	D.25
2437720000	HS 4.2-12.7/25 MM Y	D.25
2437730000	HS 4.2-12.7/50 MM W	D.26
2437740000	HS 4.2-12.7/50 MM Y	D.26
2437750000	HS 6.4-19.1/25 MM W	D.25
2437760000	HS 6.4-19.1/25 MM Y	D.25
2437770000	HS 6.4-19.1/50 MM W	D.26
2437780000	HS 6.4-19.1/50 MM Y	D.26
2437790000	HS 8.5-25.4/25 MM W	D.25
2437800000	HS 8.5-25.4/25 MM Y	D.25
2437810000	HS 8.5-25.4/50 MM W	D.26
2437820000	HS 8.5-25.4/50 MM Y	D.26
2437830000	HS-HF 1.2-2.4/25 MM W	D.27
2437840000	HS-HF 1.2-2.4/25 MM Y	D.27
2437850000	HS-HF 1.2-2.4/50 MM W	D.27
2437860000	HS-HF 1.2-2.4/50 MM Y	D.27
2437870000	HS-HF 1.6-3.2/25 MM W	D.27
2437880000	HS-HF 1.6-3.2/25 MM Y	D.27
2437890000	HS-HF 1.6-3.2/50 MM W	D.27
2437900000	HS-HF 1.6-3.2/50 MM Y	D.27
2437910000	HS-HF 12.7-25.4/25 MM W	D.27
2437920000	HS-HF 12.7-25.4/25 MM Y	D.27
2437930000	HS-HF 12.7-25.4/50 MM W	D.27
2437940000	HS-HF 12.7-25.4/50 MM Y	D.27
2437950000	HS-HF 19.5-38.1/25 MM W	D.27
2437960000	HS-HF 19.5-38.1/25 MM Y	D.27
2437970000	HS-HF 19.5-38.1/50 MM W	D.27
2437980000	HS-HF 19.5-38.1/50 MM Y	D.27
2437990000	HS-HF 2.4-4.8/25 MM W	D.27
2438000000	HS-HF 2.4-4.8/25 MM Y	D.27
2438010000	HS-HF 2.4-4.8/50 MM W	D.27
2438020000	HS-HF 2.4-4.8/50 MM Y	D.27
2438030000	HS-HF 3.2-6.4/25 MM B	D.27
2438040000	HS-HF 3.2-6.4/25 MM W	D.27
2438050000	HS-HF 3.2-6.4/25 MM Y	D.27
2438060000	HS-HF 3.2-6.4/50 MM W	D.27
2438070000	HS-HF 3.2-6.4/50 MM Y	D.27
2438080000	HS-HF 4.8-9.5/25 MM B	D.27
2438090000	HS-HF 4.8-9.5/25 MM W	D.27
2438100000	HS-HF 4.8-9.5/25 MM Y	D.27
2438110000	HS-HF 4.8-9.5/50 MM W	D.27
2438120000	HS-HF 4.8-9.5/50 MM Y	D.27

Order No.	Type	Page
2438130000	HS-HF 6.4-12.7/25 MM B	D.27
2438140000	HS-HF 6.4-12.7/25 MM W	D.27
2438150000	HS-HF 6.4-12.7/25 MM Y	D.27
2438160000	HS-HF 6.4-12.7/50 MM W	D.27
2438170000	HS-HF 6.4-12.7/50 MM Y	D.27
2438180000	HS-HF 9.5-19.1/25 MM R	D.27
2438190000	HS-HF 9.5-19.1/25 MM W	D.27
2438200000	HS-HF 9.5-19.1/25 MM Y	D.27
2438210000	HS-HF 9.5-19.1/50 MM W	D.27
2438220000	HS-HF 9.5-19.1/50 MM Y	D.27
2438500000	THM MMP ROLLER TB	D.5
2438510000	MCP PLUS 2	C.13
2438520000	MCP BASIC 2	C.15

## 2440000000

2445070000	WAD 12 MC NE WS	C.97
2445080000	WAD 12 MC NE GE	C.97
2445090000	WAD 12 MC B GE/SW	C.97
2445100000	WAD 12 MC SDR	C.97
2448860000	DEK-A 5/8 MM WS	D.11
2448880000	RIBBON MM-HS 60/300 SW	D.17
2448880000	RIBBON MM-HS 60/300 SW	D.18
2448880000	RIBBON MM-HS 60/300 SW	D.25
2448880000	RIBBON MM-HS 60/300 SW	D.26
2448880000	RIBBON MM-HS 60/300 SW	D.27
2448880000	RIBBON MM-HS 60/300 SW	D.28
2448880000	RIBBON MM-HS 60/300 SW	D.5
2448880000	RIBBON MM-HS 60/300 SW	D.7
2448920000	WS-A 12/8 MM WS	D.11
2448930000	WS-A 8/8 MM WS	D.11

## 2450000000

2455620000	THM MT30X 101/74 WS	D.42
2457760000	THM MMP CASE	D.5

## 2490000000

2493070000	MCP PLUS 2 COVER	C.13
2493080000	MCP BASIC 2 COVER	C.15

## 2510000000

2518500000	MF 8/5 MM WS	D.12
2518600000	THM MMP ROLLER MF	D.5
2518620000	ELS 7/40 MM WS	D.16
2518620000	ELS 7/40 MM WS	F.7
2518650000	SFX 11/60 MM SW	D.17
2518680000	EL 12 MM BL 30M	D.39
2518700000	THM EL VIN 100 WS 30M	D.43
2518740000	HSS-HF 1.2-2.4 EL SW30M	D.31
2518920000	HSS-HF 1.6-3.2 EL SW30M	D.31
2518930000	HSS-HF 2.4-4.8 EL SW30M	D.31
2518940000	HSS-HF 3.2-6.4 EL SW30M	D.31
2518950000	HSS-HF 4.8-9.5 EL SW30M	D.31
2518960000	HSS-HF 6.4-12.7 EL SW30M	D.31
2518970000	HSS-HF 9.5-19.1 EL SW30M	D.31
2518980000	HSS-HF 12.7-25.4 EL SW30M	D.31
2518990000	EL 15 MM BL 30M	D.39
2519000000	EL 27 MM BL 30M	D.39
2519010000	EL 38 MM BL 30M	D.39
2519020000	EL 60 MM BL 30M	D.39
2519030000	EL 100 MM BL 30M	D.39
2519040000	SFX 11/60 MM RT	D.17
2519050000	SFX 11/60 MM GN	D.17
2519060000	SFX 11/60 MM BL	D.17
2519070000	SFX 9/24 MM SW	D.17
2519080000	SFX 9/24 MM GN	D.17
2519090000	SFX 9/24 MM RT	D.17
2519100000	SFX 9/24 MM BL	D.17
2519110000	SFX 30/60 MM GN	D.17
2519120000	SFX 30/60 MM SW	D.17
2519130000	SFX 30/60 MM RT	D.17
2519140000	SFX 30/60 MM BL	D.17
2519150000	THM MMP ROLLER MF-W	D.5
2519160000	ELS 7/40 MM GE	F.6
2519160000	ELS 7/40 MM GE	D.17
2519170000	MF 10/5 MM WS	D.12
2519180000	MF 10/6 MM WS	D.12
2519190000	MF 10/8 MM WS	D.12
2519200000	MF 5	



Order No.	Type	Page
2556950000	FF 67 54/230V GY	G.4
2556960000	FF 67 54/230V BK	G.4
2556970000	FF 67 55/230V GY	G.4
2556980000	FF 67 55/230V BK	G.4
2557000000	FF-SL 65 55/230V GY	G.7
2557010000	FF-SL 65 55/230V BK	G.7
2557030000	FF-SL 67 55/230V GY	G.7
2557040000	FF-SL 67 55/230V BK	G.7
2557050000	FF-FIMT 6X 55	G.9
2557070000	EF 10 54 GY	G.5
2557080000	EF 10 54 BK	G.5
2557090000	EF 20 54 GY	G.5
2557100000	EF 20 54 BK	G.5
2557110000	EF 20 55 GY	G.5
2557120000	EF 20 55 BK	G.5
2557130000	EF 30 54 GY	G.5
2557140000	EF 30 54 BK	G.5
2557150000	EF 30 55 GY	G.5
2557160000	EF 30 55 BK	G.5
2557170000	EF 40 54 GY	G.5
2557180000	EF 40 54 BK	G.5
2557190000	EF 40 55 GY	G.5
2557200000	EF 40 55 BK	G.5
2557210000	EF 60 54 GY	G.5
2557220000	EF 60 54 BK	G.5
2557230000	EF 60 55 GY	G.5
2557240000	EF 60 55 BK	G.5
2557250000	FF-EMC 11 54/230V GY	G.6
2557260000	FF-EMC 11 54/230V BK	G.6
2557270000	FF-EMC 22 54/230V GY	G.6
2557280000	FF-EMC 22 54/230V BK	G.6
2557290000	FF-EMC 22 55/230V GY	G.6
2557300000	FF-EMC 22 55/230V BK	G.6
2557310000	FF-EMC 32 54/230V GY	G.6
2557320000	FF-EMC 32 54/230V BK	G.6
2557330000	FF-EMC 32 55/230V GY	G.6
2557340000	FF-EMC 32 55/230V BK	G.6
2557350000	FF-EMC 42 54/230V GY	G.6
2557360000	FF-EMC 42 54/230V BK	G.6
2557370000	FF-EMC 42 55/230V GY	G.6
2557380000	FF-EMC 42 55/230V BK	G.6
2557390000	FF-EMC 43 54/230V GY	G.6
2557400000	FF-EMC 43 54/230V BK	G.6
2557410000	FF-EMC 43 55/230V GY	G.6
2557420000	FF-EMC 43 55/230V BK	G.6
2557430000	FF-EMC 65 54/230V GY	G.6
2557440000	FF-EMC 65 54/230V BK	G.6
2557450000	FF-EMC 65 55/230V GY	G.6
2557460000	FF-EMC 65 55/230V BK	G.6
2557470000	FF-EMC 68 54/230V GY	G.6
2557480000	FF-EMC 68 54/230V BK	G.6
2557490000	FF-EMC 68 55/230V GY	G.6
2557500000	FF-EMC 68 55/230V BK	G.6
2557510000	FF-EMC 67 54/230V GY	G.6
2557520000	FF-EMC 67 54/230V BK	G.6
2557530000	FF-EMC 67 55/230V GY	G.6
2557540000	FF-EMC 67 55/230V BK	G.6
2557550000	EF-EMC 10 54 GY	G.7
2557560000	EF-EMC 10 54 BK	G.7
2557570000	EF-EMC 20 54 GY	G.7
2557580000	EF-EMC 20 54 BK	G.7
2557590000	EF-EMC 20 55 GY	G.7
2557600000	EF-EMC 20 55 BK	G.7
2557610000	EF-EMC 30 54 GY	G.7
2557620000	EF-EMC 30 54 BK	G.7
2557630000	EF-EMC 30 55 GY	G.7
2557640000	EF-EMC 30 55 BK	G.7
2557650000	EF-EMC 40 54 GY	G.7
2557660000	EF-EMC 40 54 BK	G.7
2557670000	EF-EMC 40 55 GY	G.7
2557680000	EF-EMC 40 55 BK	G.7
2557690000	EF-EMC 60 54 GY	G.7
2557700000	EF-EMC 60 54 BK	G.7
2557710000	EF-EMC 60 55 GY	G.7
2557720000	EF-EMC 60 55 BK	G.7
2557730000	RFF 605 54/230V GY	G.8
2557740000	RFF 605 33/230V GY	G.8
2557750000	RFF-FIMT 605X 54	G.9
2557760000	RFF 607 54/230V GY	G.8
2557780000	RFF 607 33/230V GY	G.8
2557790000	RFF-FIMT 607/610 54	G.9
2557810000	RFF 610 54/230V GY	G.8
2557820000	RFF 610 33/230V GY	G.8
2557840000	REF 600 54 GY	G.8
2557850000	REF 600 33 GY	G.8
2557860000	RH-CBCD 10W 110-250V BK	G.11
2557870000	RH-CBCD 20W 110-250V BK	G.11
2557880000	RH-CBCD 30W 110-250V BK	G.11
2557890000	RH-CBCD 30W 110-250V	G.11
2557900000	RH-CBCD 45W 110-250V	G.11
2557910000	RH-TCO 30W 110-250V	G.11
2557920000	RH-TCO 45W 110-250V	G.11
2557930000	RH-CBCD 75W 110-250V	G.11
2557940000	RH-CBCD 100W 110-250V	G.11
2557950000	RH-CBCD 150W 110-250V	G.11
2557960000	RH-TCO 75W 110-250V	G.11
2557970000	RH-TCO 100W 110-250V	G.11
2557980000	RH-TCO 150W 110-250V	G.11
2557990000	FH-TCO 250W 230V	G.12

Order No.	Type	Page
2558000000	FH-TCO 400W 230V	G.12
2558010000	FH-TCO 200W 230V BK	G.12
2558020000	FH-TCO 300W 230V BK	G.12
2558030000	FH-TCO 400W 230V BK	G.12
2558040000	FH-TCO 500W 230V BK	G.12
2558050000	FH-TCO 650W 230V BK	G.12
2558060000	FH-TCO 800W 230V BK	G.12
2558070000	FH-TCO 1000W 230V BK	G.12
2558080000	FH-TCO 1200W 230V BK	G.12
2558090000	FH-TH 200W 230V BK	G.13
2558100000	FH-TH 300W 230V BK	G.13
2558110000	FH-TH 400W 230V BK	G.13
2558120000	FH-TH 500W 230V BK	G.13
2558130000	FH-TH 650W 230V BK	G.13
2558140000	FH-TH 800W 230V BK	G.13
2558150000	FH-TH 1000W 230V BK	G.13
2558160000	FH-TH 1200W 230V BK	G.13
2558170000	THSW 1K -20°+40°C CO	G.15
2558180000	THSW 3K -20°+40°C CO	G.15
2558190000	THSW 1K 0°+60°C CO	G.15
2558200000	THSW 3K 0°+60°C CO	G.15
2558210000	THSW -20°+40°C NC	G.15
2558220000	THSW -20°+40°C NO	G.15
2558230000	THSW 0°+60°C NC	G.15
2558240000	THSW 0°+60°C NO	G.15
2558250000	THSW 0°+60°C NO/NC	G.15
2558260000	THSW 0°+60°C NO/NO	G.15
2558270000	HYSW 40-90% R.F. CO	G.16
2558280000	HYTH-SW 40-90% R.F. CO	G.16

## 2560000000

2562680000	CD-LB	G.28
2562690000	EXRV 6.5	G.27
2562700000	EXRV 4.5	G.27
2562710000	EXRV-T 6.5	G.27
2562720000	EXRV-T 4.5	G.27
2562770000	CD-FLEX 12.5X12.5	G.24
2562780000	CD-FLEX 20X20	G.24
2562790000	CD-FLEX 30X30	G.24
2562800000	CD-FLEX 40X40	G.24
2562850000	CD-LBH	G.28
2567310000	FF-FIMT 6X 54	G.9

## 2580000000

2588450000	CD 30X25 8/12 GY	G.21
2588460000	CD 40X25 8/12 GY	G.21
2588470000	CBC 20/30 BK	G.27
2588480000	CBC 15/50 BK	G.27
2588490000	CBC 8/100 BK	G.27
2588500000	CBC-SP 14-120/25 BK	G.27
2588510000	CD 60X25 8/12 GY	G.21
2588520000	CBC-SP 12-100/25 BK	G.27
2588530000	CD 80X25 8/12 GY	G.21
2588540000	CD 100X25 8/12 GY	G.21
2588550000	CBC-SP 8/70/25 BK	G.27
2588560000	CD 30X40 8/12 GY	G.21
2588570000	CBC-SP 5-50/25 BK	G.27
2588580000	CD 40X40 8/12 GY	G.21
2588590000	CBC-SP 2-12/50 BK	G.27
2588600000	CD 60X40 8/12 GY	G.21
2588610000	CD 80X40 8/12 GY	G.21
2588620000	CBC-SP 14-120/25 V2 WT	G.27
2588630000	CD 100X40 8/12 GY	G.21
2588640000	CBC-SP 12-100/25 V2 WT	G.27
2588650000	CD 30X60 8/12 GY	G.21
2588660000	CD 40X60 8/12 GY	G.21
2588670000	CBC-SP 5-50/25 V2 WT	G.27
2588680000	CD 60X60 8/12 GY	G.21
2588690000	CBC-SP 2-12/50 V2 WT	G.27
2588700000	CD 80X60 8/12 GY	G.21
2588710000	CBC-SP 18-140/20 TP	G.27
2588720000	CD 100X60 8/12 GY	G.21
2588730000	CD 40X80 8/12 GY	G.21
2588740000	CBC-SP 14-120/25 TP	G.27
2588750000	CD 60X80 8/12 GY	G.21
2588760000	CBC-SP 12-100/25 TP	G.27
2588770000	CD 80X80 8/12 GY	G.21
2588780000	CBC-SP 8/70/25 TP	G.27
2588790000	CD-BD 100X80 8/12 GY	G.21
2588800000	CD-BD 40X100 8/12 GY	G.21
2588810000	CBC-SP 5-50/25 TP	G.27
2588820000	CD 60X100 8/12 GY	G.21
2588830000	CBC-SP 2-12/50 TP	G.27
2588840000	CD 80X100 8/12 GY	G.21
2588850000	CD-BD 100X100 8/12 GY	G.21
2588860000	CBC-FB 50-75/50	G.28
2588870000	CD 150X100 8/12 GY	G.21
2588880000	CBC-FB 30-45/100	G.28
2588890000	CD-BD 40X120 8/12 GY	G.21
2588900000	CBC-FB 20-30/100	G.28
2588910000	CD-BD 60X120 8/12 GY	G.21
2588920000	CD-BD 80X120 8/12 GY	G.21
2588930000	CBC-FB 10-18/200	G.28
2588940000	CD-BD 100X120 8/12 GY	G.21
2588950000	CBC-FB 5-10/200	G.28
2588960000	CD-BD 60X150 8/12 GY	G.21
2588970000	CD-BD 80X150 8/12 GY	G.21

Order No.	Type	Page
2588980000	CD-LID 125 DKGY	G.24
2588990000	CD-BD 100X150 8/12 GY	G.21
2589000000	CD-LID 100 DKGY	G.24
2589010000	CD-BD 60X200 8/12 GY	G.21
2589020000	CD-LID 75 DKGY	G.24
2589030000	CD-BD 80X200 8/12 GY	G.21
2589040000	CD-BD 100X200 8/12 GY	G.21
2589050000	CD-LID 50 DKGY	G.24
2589060000	CD 17X15 4/6 GY	G.20
2589070000	CD-LID 37.5 DKGY	G.24
2589080000	CD 30X15 4/6 GY	G.20
2589090000	CD-LID 25 DKGY	G.24
2589100000	CD 40X15 4/6 GY	G.20
2589110000	CD 30X25 4/6 GY	G.20
2589120000	CD-LID 125 LTGY	G.23
2589130000	CD 40X25 4/6 GY	G.20
2589140000	CD-LID 100 LTGY	G.23
2589150000	CD 60X25 4/6 GY	G.20
2589170000	CD-LID 75 LTGY	G.23
2589180000	CD 80X25 4/6 GY	G.20
2589190000	CD 100X25 4/6 GY	G.20
2589200000	CD-LID 50 LTGY	G.23
2589210000	CD 40X40 4/6 GY	G.20
2589220000	CD-LID 37.5 LTGY	G.23
2589230000	CD 60X40 4/6 GY	G.20
2589240000	CD 80X40 4/6 GY	G.20
2589250000	CD-LID 25 LTGY	G.23
2589260000	CD 100X40 4/6 GY	G.20
2589270000	CD-HF 75X125 5/7.5 DKGY	G.23
2589280000	CD 40X60 4/6 GY	G.20
2589290000	CD-HF 75X100 5/7.5 DKGY	G.23
2589300000	CD 60X60 4/6 GY	G.20
2589310000	CD 80X60 4/6 GY	G.20
2589320000	CD-HF 50X100 5/7.5 DKGY	G.23
2589330000	CD 100X60 4/6 GY	G.20
2589340000	CD-HF 75X75 5/7.5 DKGY	G.23
2589350000	CD 40X80 4/6 GY	G.20
2589360000	CD-HF 50X75 5/7.5 DKGY	G.23
2589370000	CD 60X80 4/6 GY	G.20
2589380000	CD 80X80 4/6 GY	G.20
2589390000	CD-HF 75X50 5/7.5 DKGY	G.23
2589400000	CD-BD 100X80 4/6 GY	G.20
2589410000	CD-HF 50X50 5/7.5 DKGY	G.23
2589420000	CD 60X100 4/6 GY	G.20
2589430000	CBC 25/20 BK	G.27
2589440000	CD 80X100 4/6 GY	G.20
2589450000	CD-BD 100X100 4/6 GY	G.20
2589460000	CD-COD 110X110 4/6 GY	G.21
2589470000	CD-BD 80X120 4/6 GY	G.20
2589480000	CD-COD 90X90 4/6 GY	G.21
2589490000	CD-BD 80X120 4/6 GY	G.20
2589500000	CD-BD 100X120 4/6 GY	G.20
2589510000	CD-BD 80X100 4/6 GY	G.20
2589520000	CD 25X25 5/7.5 GY	G.22
2589530000	CD-BD 80X100 4/6 GY	G.20
2589540000	CD 37.5X25 5/7.5 GY	G.22
2589550000	CD-BD 80X80 4/6 GY	G.20
2589560000	CD 50X25 5/7.5 GY	G.22
2589570000	CD-BD 60X80 4/6 GY	G.20
2589580000	CD 75X25 5/7.5 GY	G.22
2589590000	CD 37.5X37.5 5/7.5 GY	G.22
2589600000	CD-BD 40X80 4/6 GY	G.20
2589610000	CD 50X37.5 5/7.5 GY	G.22
2589620000	CD-BD 80X60 4/6 GY	G.20
2589630000	CD 75X37.5 5/7.5 GY	G.22
2589640000		

Order No.	Type	Page
2621270000	CC-FD 85/54 MM SI	D.38
2621280000	CC-FD 30/60 MM WS	D.38
2621290000	CC-FD 30/60 MM GE	D.38
2621300000	CC-FD 30/60 MM SI	D.38
2621310000	CC-FD 15/60 MM WS	D.38
2621320000	CC-FD 15/60 MM GE	D.38
2621330000	CC-FD 15/60 MM SI	D.38
2621340000	CC-FD 15/45 MM WS	D.38
2621350000	CC-FD 15/45 MM GE	D.38
2621360000	CC-FD 15/45 MM SI	D.38
2621370000	CC-FD 15/27 MM WS	D.38
2621380000	CC-FD 15/27 MM GE	D.38
2621390000	CC-FD 15/27 MM SI	D.38
2621400000	EL 6 MM WS 30M	D.39
2621410000	EL 6 MM GE 30M	D.39
2621420000	EL 9 MM WS 30M	D.39
2621430000	EL 9 MM GE 30M	D.39
2621440000	SFX-VT 11/60 MM GE	D.17
2621450000	SFX-VT 11/60 MM WS	D.17
2621460000	SFX-VT 9/24 MM GE	D.17
2621470000	SFX-VT 9/24 MM WS	D.17
2621480000	SFX-DT 11/60 MM BL	D.17
2621490000	SFX-DT 9/24 MM BL	D.17
2621500000	THM WO 20/32 WS	D.21
2621510000	THM WO 25/37 WS	D.21
2621520000	THM WO 24/69 WS	D.21
2621530000	THM WO 14/22 WS	D.21
2621550000	THM MT30X 50/18 WS	D.41
2621560000	HS-FR 1.2-2.4/25 MM Y	D.28
2621570000	HS-FR 1.2-2.4/25 MM W	D.28
2621580000	HS-FR 1.6-3.2/25 MM W	D.28
2621590000	HS-FR 1.6-3.2/25 MM Y	D.28
2621600000	HS-FR 2.4-4.8/25 MM W	D.28
2621610000	HS-FR 2.4-4.8/25 MM Y	D.28
2621620000	HS-FR 3.2-6.4/25 MM W	D.28
2621630000	HS-FR 3.2-6.4/25 MM Y	D.28
2621640000	HS-FR 4.8-9.5/25 MM W	D.28
2621650000	HS-FR 4.8-9.5/25 MM Y	D.28
2621660000	HS-FR 6.4-12.7/25 MM W	D.28
2621670000	HS-FR 6.4-12.7/25 MM Y	D.28
2621680000	HS-FR 9.5-19.1/25 MM W	D.28
2621690000	HS-FR 9.5-19.1/25 MM Y	D.28
2621700000	HS-FR 12.7-25.4/25 MM W	D.28
2621710000	HS-FR 12.7-25.4/25 MM Y	D.28
2621720000	HS-FR 19.1-38.1/25 MM W	D.28
2621730000	HS-FR 19.1-38.1/25 MM Y	D.28
2621740000	HS-FR 1.2-2.4/50 MM W	D.28
2621750000	HS-FR 1.2-2.4/50 MM Y	D.28
2621760000	HS-FR 1.6-3.2/50 MM W	D.28
2621770000	HS-FR 1.6-3.2/50 MM Y	D.28
2621780000	HS-FR 2.4-4.8/50 MM W	D.28
2621790000	HS-FR 2.4-4.8/50 MM Y	D.28
2621800000	HS-FR 3.2-6.4/50 MM W	D.28
2621810000	HS-FR 3.2-6.4/50 MM Y	D.28
2621820000	HS-FR 4.8-9.5/50 MM W	D.28
2621830000	HS-FR 4.8-9.5/50 MM Y	D.28
2621840000	HS-FR 6.4-12.7/50 MM W	D.28
2621850000	HS-FR 6.4-12.7/50 MM Y	D.28
2621860000	HS-FR 9.5-19.1/50 MM W	D.28
2621870000	HS-FR 9.5-19.1/50 MM Y	D.28
2621880000	HS-FR 12.7-25.4/50 MM W	D.28
2621890000	HS-FR 12.7-25.4/50 MM Y	D.28
2621900000	HS-FR 19.1-38.1/50 MM W	D.28
2621910000	HS-FR 19.1-38.1/50 MM Y	D.28
2625660000	THM WO VIN 25.4/36.5 GE IW	D.22

## 2650000000

2657100000	THM WO VIN 12.7/19 WS	D.22
2657110000	THM WO VIN 12.7/38.1 WS	D.22
2657120000	THM WO VIN 25.4/19 WS	D.22
2657130000	THM WO VIN 25.4/19 SP WS	D.22
2657140000	THM WO VIN 25.4/31.8 WS	D.22
2657150000	THM WO VIN 25.4/31.8 SP WS	D.22
2657160000	THM WO VIN 25.4/38.1 WS	D.22
2657170000	THM WO VIN 25.4/38.1 SP WS	D.22
2657180000	THM WO VIN 25.4/57.2 WS	D.22
2657190000	THM WO VIN 25.4/57.2 SP WS	D.22
2657200000	THM WO VIN 25.4/63.5 WS	D.22
2657210000	THM WO VIN 25.4/63.5 SP WS	D.22
2659310000	CB-UVR 98/2.5 BK	G.31
2659320000	CB-UVR 140/3.6 BK	G.31
2659330000	CB-UVR 200/3.6 BK	G.31
2659340000	CB-UVR 200/4.8 BK	G.31
2659350000	CB-UVR 290/4.8 BK	G.31
2659360000	CB-UVR 365/7.5 BK	G.31
2659370000	CB-HTR 98/2.5 BK	G.31
2659380000	CB-HTR 140/3.6 BK	G.31
2659390000	CB-HTR 200/3.6 BK	G.31
2659400000	CB-HTR 200/4.8 BK	G.31
2659410000	CB-HTR 290/4.8 BK	G.31
2659420000	CB-HTR 365/7.5 BK	G.31
2659430000	CB-HTR 98/2.5 NC	G.31
2659440000	CB-HTR 140/3.6 NC	G.31
2659450000	CB-HTR 200/3.6 NC	G.31
2659460000	CB-HTR 200/4.8 NC	G.31
2659470000	CB-HTR 290/4.8 NC	G.31
2659480000	CB-HTR 365/7.5 NC	G.31
2659490000	CB-VT 98/2.5 HF/V0 WT	G.30

Order No.	Type	Page
2659500000	CB-VT 140/3.6 HF/V0 WT	G.30
2659510000	CB-VT 200/3.6 HF/V0 WT	G.30
2659520000	CB-VT 200/4.8 HF/V0 WT	G.30
2659530000	CB-VT 290/4.8 HF/V0 WT	G.30
2659540000	CB-VT 365/7.5 HF/V0 WT	G.30

## 2660000000

2661600000	MM PLUS ROLLER TB	D.7
2661610000	MM PLUS ROLLER MF	D.7
2661620000	MM PLUS ROLLER MF-W	D.7
2662460000	CD 40X60 4/6 BL	G.20
2662470000	CD 40X80 4/6 BL	G.20
2662480000	CD 60X40 4/6 BL	G.20
2662490000	CD 60X60 4/6 BL	G.20
2662500000	CD 60X80 4/6 BL	G.20
2662530000	CD 60X100 4/6 BL	G.20
2662540000	CD 80X40 4/6 BL	G.20
2662550000	CD 80X60 4/6 BL	G.20
2662560000	CD 80X80 4/6 BL	G.20
2662570000	CD 80X100 4/6 BL	G.20
2662580000	CD-BO 100X80 4/6 BL	G.20
2662590000	CD-BO 100X100 4/6 BL	G.20
2662600000	CD 60X25 4/6 BL	G.20
2662610000	CD 80X25 4/6 BL	G.20
2662620000	CD 100X25 4/6 BL	G.20
2662630000	CD 100X40 4/6 BL	G.20
2662640000	CD 100X60 4/6 BL	G.20
2662650000	CD 40X40 4/6 BL	G.20
2662660000	CD 40X25 4/6 BL	G.20

## 2680000000

2681820000	ESG-FI 12/6 MC NE WS	C.145
2681830000	ESG-FI 9/15 MC NE WS	C.145
2681850000	ESG-FI 9/25 MC NE WS	C.146
2681860000	ESG 8/17 OF MC NE WS	C.135
2681880000	ZS 30/5 MC NE WS	C.52
2681910000	ESG-FI 12/6 MC SDR	C.145
2681960000	ESG-FI 9/15 MC SDR	C.145
2682010000	ESG-FI 9/25 MC SDR	C.146
2682060000	ESG 8/17 OF MC SDR	C.135
2682070000	ZS 30/5 MC SDR	C.52
2682080000	SNAPMARK 1.5	F.6

## 2700000000

2704800000	CD-HF 37.5X25 5/7.5 BL	G.23
2704810000	CD-HF 37.5X37.5 5/7.5 BL	G.23
2704820000	CD-HF 50X25 5/7.5 BL	G.23
2704830000	CD-HF 50X37.5 5/7.5 BL	G.23
2704840000	CD-HF 50X50 5/7.5 BL	G.23
2704850000	CD-HF 50X75 5/7.5 BL	G.23
2704860000	CD-HF 50X100 5/7.5 BL	G.23
2704870000	CD-HF 75X25 5/7.5 BL	G.23
2704880000	CD-HF 75X37.5 5/7.5 BL	G.23
2704890000	CD-HF 75X50 5/7.5 BL	G.23
2704900000	CD-HF 75X75 5/7.5 BL	G.23
2704910000	CD-HF 75X100 5/7.5 BL	G.23
2704920000	CD-HF 75X125 5/7.5 BL	G.23
2705010000	RAILLASER	C.5

## 2710000000

2711870000	THM WO-Q 25/19.1 WS	D.21
2711880000	THM WO-Q 25/31.8 WS	D.21
2711890000	THM WO-Q 25/38.1 WS	D.21
2711900000	THM WO-Q 25/51.4 WS	D.21
2711910000	THM WO-Q VIN 25/19.1 WS	D.22
2711920000	THM WO-Q VIN 25/31.8 WS	D.22
2711930000	THM WO-Q VIN 25/38.1 WS	D.22
2711940000	THM WO-Q VIN 25/51.4 WS	D.22
2711950000	THM WO-QX 25/100 WS	D.21
2711960000	THM WO-QX 25/38.1 WS	D.21
2711970000	THM WO-QX VIN 25/100 WS	D.22
2711980000	THM WO-QX VIN 25/38.1 WS	D.22
2711990000	THM WO 25.4/93 WS	D.21
2712020000	THM GEW 20/10 WS	D.43
2712030000	THM GEW 20/10 GE	D.43
2712040000	THM MT30X DIA 30 GE	D.42
2712050000	THM MT30X 17/8 WS	D.41
2712060000	SM-FD 22/22 MM WS	D.36
2712070000	SM-FD 22/22 MM SI	D.36
2712080000	SM-FD 22/22 MM GE	D.36
2712090000	SFX 9/24 MM BP WS	D.17
2712100000	SFX 9/24 MM BP GE	D.17
2712110000	SFX 11/60 MM BP WS	D.17
2712120000	SFX 11/60 MM BP GE	D.17
2712130000	WS 10/5 MM WS	D.11
2712130000	WS 10/5 MM WS	F.6
2712130000	WS 10/5 MM WS	F.8
2712140000	WS 10/6 MM WS	D.11
2712150000	MF 10/5 MM BP WS	D.12
2712160000	MF 10/6 MM BP WS	D.12
2712170000	MF 10/8 MM BP WS	D.12
2713810000	THM MT30X 18/6.5 SI	D.41
2715590000	PRINTJET CONNECT	C.11
2715600000	PJ CON INK SET	C.11
2715610000	PJ CON INK C	C.11

Order No.	Type	Page
2715620000	PJ CON INK M	C.11
2715630000	PJ CON INK Y	C.11
2715640000	PJ CON INK K	C.11
2715650000	PJ CON FLUID SET	C.11
2715660000	PJ CON WASTE PAD	C.11
2715670000	PJ CON TEXTILE COVER	C.11
2715680000	PJ CON WIFI STICK	C.11
2719150000	SFM 3/12 2.5-3.3 MM WS	D.15
2719160000	SFM 3/18 2.5-3.3 MM WS	D.15
2719170000	SFM 3/24 2.5-3.3 MM WS	D.15
2719180000	SFM 3/12 2.5-3.3 MM GE	D.15
2719190000	SFM 3/18 2.5-3.3 MM GE	D.15
2719200000	SFM 3/24 2.5-3.3 MM GE	D.15
2719270000	THM MMP ROLLER SFM 3	D.5
2719270000	THM MMP ROLLER SFM 3	D.7

## 2730000000

2737720000	CC-DT 30/60 MC NE BL	C.162
2737730000	CC-DT 30/60 K MC NE BL	C.162
2737740000	CC-DT 85/54 MC NE BL	C.164
2737750000	CC-DT 85/54 K MC NE BL	C.164
2737780000	SM-DT 27/27 K MC NE BL	C.152
2737790000	SM-DT 27/27 K MC NE BL	C.152
2737800000	SM-DT-H 27/27 BL	C.152

## 7940000000

7940006040	CB 135/2.5 NATUR	G.30
7940006047	CB 135/2.5 BLACK	G.30
7940006048	CB 160/2.6 NATUR	G.30
7940006049	CB 160/2.6 BLACK	G.30
7940006050	CB 200/2.6 NATUR	G.30
7940006051	CB 200/2.6 BLACK	G.30
7940006054	CB 250/4.8 NATUR	G.30
7940006056	CB 250/4.8 BLACK	G.30
7940006056	CB 370/3.5 NATUR	G.30
7940006057	CB 370/3.5 BLACK	G.30
7940006058	CB 390/4.5 NATUR	G.30
7940006059	CB 390/4.5 BLACK	G.30
7940006060	CB 430/4.5 NATUR	G.30
7940006061	CB 430/4.5 BLACK	G.30
7940006064	CB 180/7.8 NATUR	G.30
7940006065	CB 180/7.8 BLACK	G.30
7940006066	CB 240/7.8 NATUR	G.30
7940006067	CB 240/7.8 BLACK	G.30
7940006068	CB 300/7.8 NATUR	G.30
7940006069	CB 300/7.8 BLACK	G.30
7940006070	CB 450/7.5 NATUR	G.30
7940006071	CB 450/7.5 BLACK	G.30
7940006072	CB 540/7.5 NATUR	G.30
7940006073	CB 540/7.5 BLACK	G.30
7940006074	CB 780/9.0 NATUR	G.30
7940006075	CB 780/9.0 BLACK	G.30
7940006076	CB 225/12.5 NATUR	G.30
7940006077	CB 225/12.5 BLACK	G.30
7940006078	CB 500/12.5 NATUR	G.30
7940006079	CB 500/12.5 BLACK	G.30
7940006082	CB 850/12.5 NATUR	G.30
7940006085	CB 1000/12.5 BLACK	G.30



# Adressen weltweit

Let's connect.

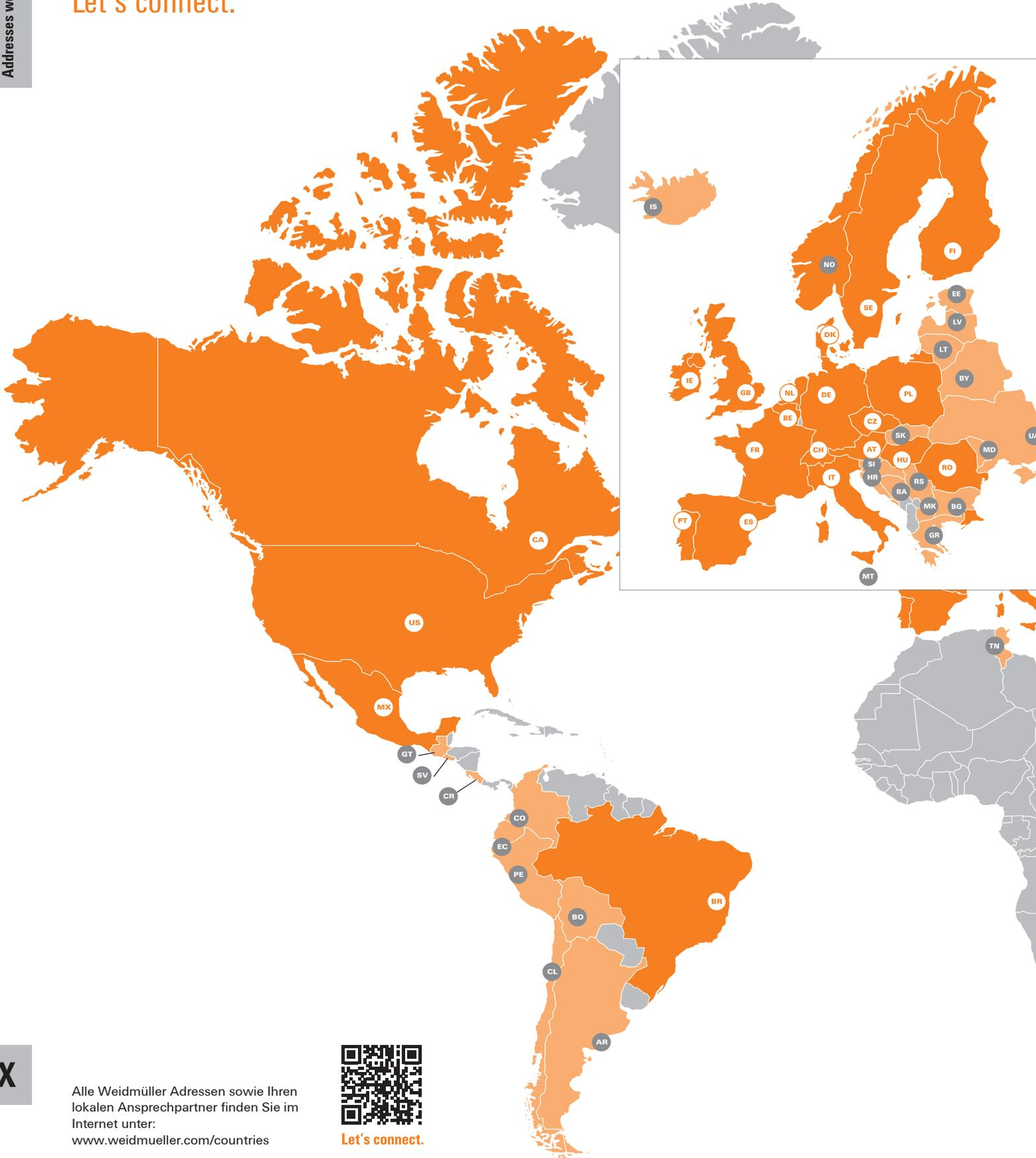

X

Alle Weidmüller Adressen sowie Ihren lokalen Ansprechpartner finden Sie im Internet unter:  
[www.weidmueller.com/countries](http://www.weidmueller.com/countries)



Let's connect.

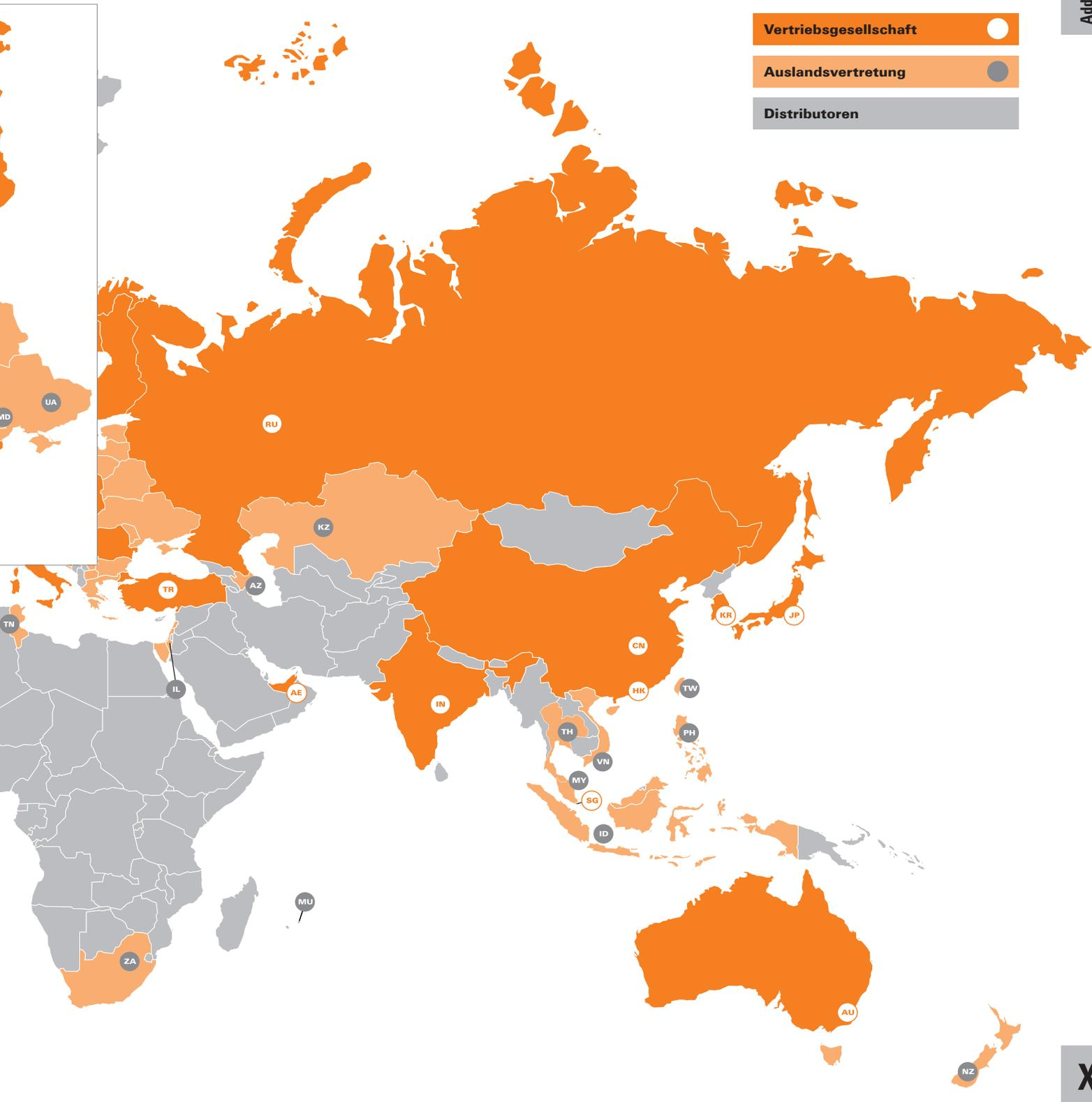

We cannot guarantee that there are no mistakes in the publications or software provided by us to the customer for the purpose of making orders. We try our best to quickly correct errors in our printed media.

**X**

All orders are based on our general terms of delivery, which can be reviewed on the websites of our group companies where you place your order. On demand we can also send the general terms of delivery to you.



## Weidmüller – Your partner in Industrial Connectivity

As experienced experts we support our customers and partners around the world with products, solutions and services in the industrial environment of power, signal and data. We are at home in their industries and markets and know the technological challenges of tomorrow. We are therefore continuously developing innovative, sustainable and useful solutions for their individual needs. Together we set standards in Industrial Connectivity.

Weidmüller Interface GmbH & Co. KG  
Klingenbergstraße 26  
32758 Detmold, Germany  
T +49 5231 14-0  
F +49 5231 14-292083  
[www.weidmueller.de](http://www.weidmueller.de)

Personal support can  
be found on our website:  
[www.weidmueller.com/contact](http://www.weidmueller.com/contact)

Made in Germany



Order No.: 2712610000/12/2020/SMD



## X-ON Electronics

Largest Supplier of Electrical and Electronic Components

*Click to view similar products for [Heat Shrink Tubing and Sleeves](#) category:*

*Click to view products by [Weidmuller](#) manufacturer:*

Other Similar products are found below :

[5685710001](#) [CR9960-000](#) [5734012004](#) [607381P039](#) [611112-000](#) [6284592002](#) [CX4711-000](#) [CZ1420-000](#) [D-306-38](#) [770-006S302](#) [770-010Y106W1](#) [770-018S103](#) [770-018S202W1](#) [770-018S205W1](#) [770-020S704W1](#) [770-020S705](#) [MFP-1/4"-Clear](#) [MFP-3/64"-Clear](#) [790-3012](#) [MHHT-4-15K2-G-104](#) [8003012003](#) [MIL-LT-1-1/2-4-SP](#) [MIL-LT-1-1/2-9-STK](#) [MIL-LT-1/2-2-STK](#) [MIL-LT-3/32-0-SP](#) [MIL-LT-3/32-6-SP](#) [MIL-LT-3/4-4-STK](#) [MIL-LT-3/4-6-SP](#) [839602-000](#) [8423-6](#) [FP301-116-48"-Clear](#) [FP301-12-6"-Clear](#) [FP301-1/4-48"-White-Hdr](#) [FP301-18-48"-Black-Hdr](#) [FP301-1/8-6"-Black](#) [FP301-18-6"-Black-Bulk](#) [FP301-316-48"-Blue-Hdr](#) [FP301-34-48"-Green-Hdr](#) [912229N002](#) [R280637030](#) [HDCW-5515-1000](#) [HDT-0300-48A-BLACK](#) [HDT-0400-48A-Black](#) [HDT-0800-48A-RED](#) [HDT1100-48A-BLK](#) [HDT1500-48A-BLK](#) [HDT-2000-48A-Black](#) [RHW-70/20-1200/ADH-0](#) [DWP-125-0.450-4-55MM-CS879](#) [156082-000](#)