



● **WS系列 WS Series**

型号 Part number system



● **注:** 连接器根据接触对数量, 其每一对的额定电流按下表规定的下降计算。

Remarks: The rated current decreases according to the number of contacts, more contacts, less rated current.

接触对芯数 Number of contact	1~3	4~10	11~20	21~30	31~40	41~50	51~61
下降率 (%) Rated current decrease rate	0	10	20	30	40	50	60

★ 焊接芯件参数表见97-98页

Solder contact spec see page 97-98

★ 接触件可以是插针或插孔

Each side can be male or female contact

★ 压接芯件参数表见99-102页

Crimp contact spec see page 99-102

材料和技术参数 Material and spec

接插方式	Coupling	螺纹连接	Threaded
外壳材料	Shell material	锌合金(镀铬)	Zinc alloy with chrome plating
绝缘体	Insert material	热塑塑料PPS, 耐高温260℃	PPS, max temperature 260 °C
接触件材料	Contact material	铜(镀金)	Brass with gold plating
接线方式	Termination	焊接: $\phi 1$ 、 $\phi 2.5$ 、 $\phi 3.5$ 、 $\phi 5.5$ mm; 螺丝压接: $\phi 2.5$ 、 $\phi 3$ 、 $\phi 3.5$ mm; 压接: $\phi 1$ 、 $\phi 1.5$ 、 $\phi 2.5$ 、 $\phi 3.5$ 、 $\phi 5.5$ 、 $\phi 10$ mm Solder: $\phi 1$ 、 $\phi 2.5$ 、 $\phi 3.5$ 、 $\phi 5.5$ mm; Screw: $\phi 2.5$ 、 $\phi 3$ 、 $\phi 3.5$ mm; Crimp: $\phi 1$ 、 $\phi 1.5$ 、 $\phi 2.5$ 、 $\phi 3.5$ 、 $\phi 5.5$ 、 $\phi 10$ mm	
接插次数	Mating cycle	500	
温度范围	Temperature range	-40℃~+85℃	

WS系列配套表 WS Series Mating diagram

◆ 方形法兰插座
Square flange receptacle



Z

◆ 后螺母插座
Round flange receptacle



ZM

◆ 前螺母插座
Front-nut-mount receptacle



ZMQ

◆ 2孔法兰插座
2-hole flange receptacle with cap



ZG

◆ 直式对接双压板电缆插座
In-line receptacle with cable clamping plates



ZYB
ZY

◆ 直式对接电缆护套插座
In-line receptacle with PVC sleeve

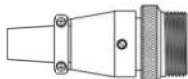

ZQB
ZQ

◆ 直式对接金属软管插座
In-line receptacle for metal hose

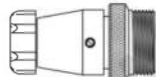

ZPB
ZP

◆ 直式对接塑料软管插座
In-line receptacle for plastic-hose

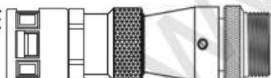

ZDB
ZD

◆ 弯式对接金属软管插座
In-line receptacle with angled back shell for metal-hose

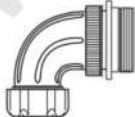

ZR

◆ 弯式对接双压板电缆插座
In-line receptacle with angled back shell and cable clamping plates

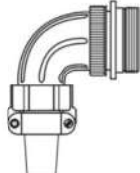

ZS

◆ 弯式对接塑料软管插座
In-line receptacle with angled back shell for plastic-hose

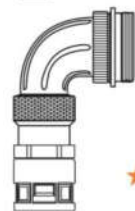

ZC

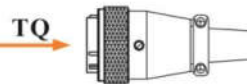

◆ 直式电缆护套插头
Plug with PVC sleeve

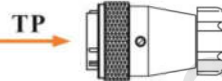

◆ 直式金属软管插头
Plug for metal-hose

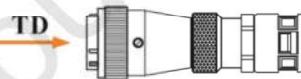

◆ 直式塑料软管插头
Plug for plastic-hose

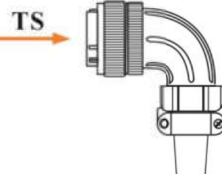

◆ 弯式双压板电缆插头
Plug with angled back shell and cable clamping plates

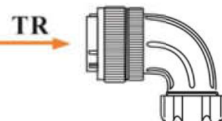

◆ 弯式金属软管插头
Plug with angled back shell for metal-hose

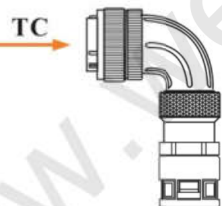

◆ 弯式塑料软管插头
Plug with angled back shell for plastic-hose



◆ 插座塑料防尘盖
Plastic receptacle cap

★ 接触件可以是插针或插孔
Each side can be male or female contact

★ 焊接芯件参数表见97-98页
Solder contact spec see page 97-98

★ 压接芯件参数表见99-102页
Crimp contact spec see page 99-102



● 方形法兰插座: Z Square flange mount receptacle: Z

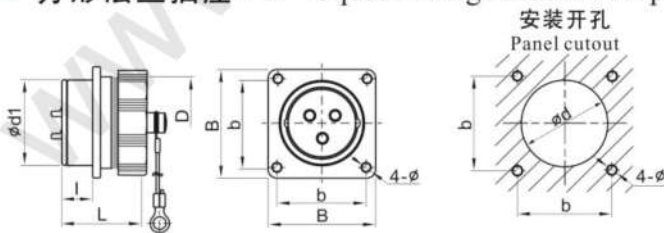

尺寸 Dimension(mm)	WS16	WS20	WS24	WS28	WS32	WS40	WS48	WS55
$\phi d1$	15.8	19.8	23.8	27.8	31.8	39.8	47.8	54.8
D	M18X1	M22X1	M26X1	M30X1	M35X1.5	M44X1.5	M52X1.5	M59X1.5
I	9.7	9.8	10	9.8	14.4	14.2	14.2	14
L	21.6	23	23	23	34	34	34	34
b	20	22	26	30	32	40	48	52
B	26	29	32	36	42	50	58	64
ϕd	16.5	20.5	24.5	28.5	32.5	40.5	48.5	55.5
ϕ	3.2	3.2	3.2	3.2	3.5	4.5	4.5	4.5

● 后螺母插座: ZM Round flange receptacle: ZM

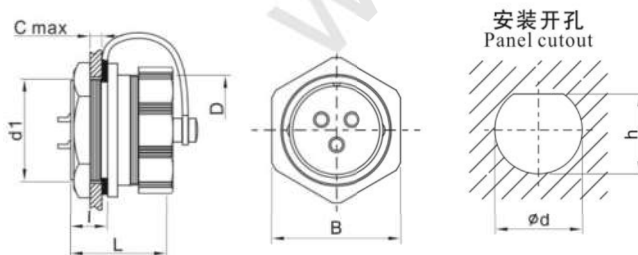

尺寸 Dimension(mm)	WS16	WS20	WS24	WS28
d1	M16X1	M20X1	M24X1	M28X1
D	M18X1	M22X1	M26X1	M30X1
C	5	5	5	5
I	9.7	9.9	10	10.2
L	22	23	23	23
B	21.2	25.5	29.2	33.3
ϕd	15.7	19.7	23.9	27.7
h	15.3	19.3	23.2	26.9



● 前螺母插座: ZMQ IP67 Front-nut-mount receptacle: ZMQ IP67

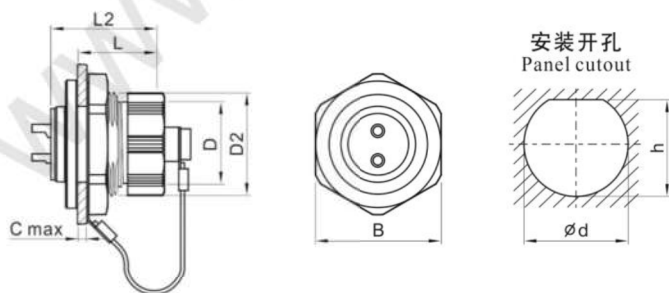

尺寸 Dimension(mm)	WS16	WS20	WS24	WS28
øD	M18X1	M22X1	M26X1	M30X1
D2	M22X1	M26X1	M30X1	M34X1
L	16	17	17	17
L2	21.6	23	23	23
C	5	5	5	5
B	26.8	30.8	34.8	38.8
ød	22	26	30	34
h	20.6	24.6	28.6	32.6

● 2孔法兰插座: ZG 2-hole flange receptacle with cap: ZG

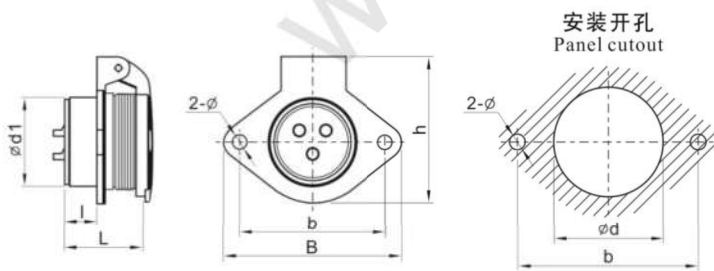

尺寸 Dimension(mm)	WS16	WS20	WS24	WS28	WS32	WS40	WS48	WS55
ød1	15.8	19.8	23.8	27.8	31.8	39.8	47.8	54.8
l	10	10	10	10	15.4	14.7	14.3	14
L	22	23	23	23	34	34	34	34
b	30	35	40	45	55	65	80	85
B	38	44	50	55	67	77	92	98
h	32.5	36.5	40.5	45.5	52.5	63.5	74.5	80
ød	16.5	20.5	24.5	28.5	32.5	40.5	48.5	55.5
ø	3.5	4.5	4.5	4.5	5.5	5.5	5.5	6.5



● 直式对接电缆护套插座B: ZQB In-line receptacle with PVC sleeve B: ZQB



尺寸 Dimension(mm)	WS16	WS20	WS24	WS28
D	M18X1	M22X1	M26X1	M30X1
L	44.3	48.3	53.5	56
ød max	10	11.6	12.4	15.7

护盖可选购尺寸见P93 Optional cap size see P93

● 直式对接电缆护套插座: ZQ In-line receptacle with PVC sleeve: ZQ

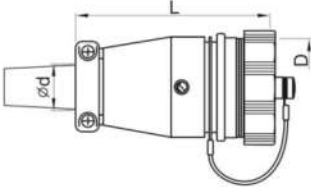

尺寸 Dimension(mm)	WS32	WS40	WS48	WS55
D	M35X1.5	M44X1.5	M52X1.5	M59X1.5
L	70	77	85	97
ød max	19.5	24	24	30

护盖可选购尺寸见P93 Optional cap size see P93

● 直式对接金属软管插座B: ZPB In-line receptacle for metal-hose B: ZPB

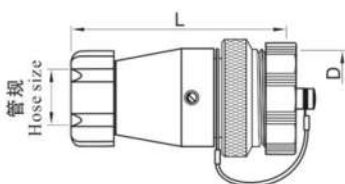

尺寸 Dimension(mm)	WS16	WS20	WS24	WS28
D	M18X1	M22X1	M26X1	M30X1
L	49.5	58	62	65
管规 Hose size	1/4"	3/8"	3/8"	1/2"

护盖可选购尺寸见第93页 Optional cap size see P93

● 直式对接金属软管插座: ZP In-line receptacle for metal-hose: ZP

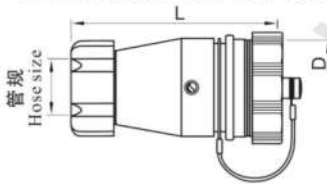

尺寸 Dimension(mm)	WS32	WS40	WS48	WS55
D	M35X1.5	M44X1.5	M52X1.5	M59X1.5
L	75	99	103	106
管规 Hose size	3/4"	1"	I: 1" (不标) II: 1 1/4"	1 1/4"

护盖可选购尺寸见第93页 Optional cap size see P93

● 直式对接双压板电缆插座B: ZYB In-line receptacle with cable clamping plates B: ZYB

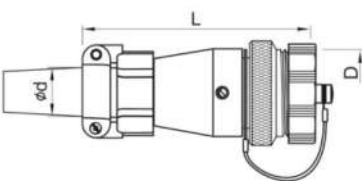

尺寸 Dimension(mm)	WS16	WS20	WS24	WS28
D	M18X1	M22X1	M26X1	M30X1
L	48.5	54.5	55.5	65.3
ød max	10	13	13	17

护盖可选购尺寸见第93页 Optional cap size see P93
电缆护套尺寸见第93页 PVC sleeve dimension see P93

● 直式对接双压板电缆插座: ZY In-line receptacle with cable clamping plates: ZY

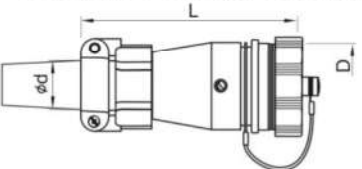

尺寸 Dimension(mm)	WS32	WS40	WS48	WS55
D	M35X1.5	M44X1.5	M52X1.5	M59X1.5
L	89.2	94.8	101.8	124.7
ød max	19	23	I: 23 (不标) II: 31	31

护盖可选购尺寸见第93页 Optional cap size see P93
电缆护套尺寸见第93页 PVC sleeve dimension see P93



● 直式对接塑料软管插座B: ZDB In-line receptacle for plastic-hose B: ZDB

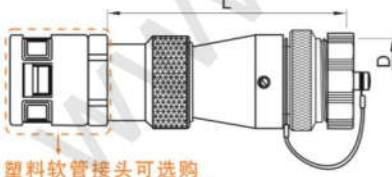

塑料软管接头可选购
Optional plastic hose adapter

尺寸 Dimension(mm)	WS16	WS20	WS24	WS28
D	M18X1	M22X1	M26X1	M30X1
L	55.5	64.5	69	75.5
接头规格 Adapter size	PG7	PG11	PG11	PG16
管规 Hose size	1/4"	3/8"	3/8"	1/2"

护盖可选购尺寸见第93页 Optional cap size see P93

● 直式对接塑料软管插座: ZD In-line receptacle for plastic-hose: ZD



塑料软管接头可选购
Optional plastic hose adapter

尺寸 Dimension(mm)	WS32	WS40	WS48	WS55
D	M35X1.5	M44X1.5	M52X1.5	M59X1.5
L	89.5	96.5	105	119.5
接头规格 Adapter size	PG21	PG29	I: PG29 (不标) II: PG36	PG36
管规 Hose size	3/4"	1"	I: 1" (不标) II: 1 1/4"	1 1/4"

护盖可选购尺寸见第93页 Optional cap size see P93

● 弯式对接金属软管插座: ZR In-line receptacle with angled back shell for metal-hose: ZR

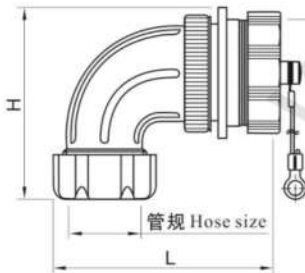

尺寸 Dimension(mm)		WS20	WS24	WS28	WS32	WS40	WS48	WS55
D	—	M22X1	M26X1	M30X1	M35X1.5	M44X1.5	M52X1.5	M59X1.5
L	—	60	60	63	81	88	96	107
H	—	48	51	52	58	70	82	90
管规 Hose size	—	3/8"	3/8"	1/2"	3/4"	1"	1"	1 1/4"

护盖可选购尺寸见第93页 Optional cap size see P93

● 弯式对接双压板电缆插座: ZS In-line receptacle with angled back shell and cable clamping plates: ZS



尺寸 Dimension(mm)		WS20	WS24	WS28	WS32	WS40	WS48	WS55
D	—	M22X1	M26X1	M30X1	M35X1.5	M44X1.5	M52X1.5	M59X1.5
L	—	60.6	60.4	64.7	82	89.2	96	114.2
H	—	54.4	56.8	64	72	83.3	94.5	112.3
ød max	—	13	13	17	19	23	23	31

护盖可选购尺寸见第93页 Optional cap size see P93



● 弯式对接塑料软管插座: ZC In-line receptacle with angled back shell for plastic-hose: ZC



塑料软管接头可选购
Optional plastic hose adapter

尺寸 Dimension(mm)		WS20	WS24	WS28	WS32	WS40	WS48	WS55
D	—	M22X1	M26X1	M30X1	M35X1.5	M44X1.5	M52X1.5	M59X1.5
L	—	60	61	63	82	88.5	95	112
H	—	88	88	98	110	120	135	140
接头规格 Adapter size	—	PG11	PG11	PG16	PG21	PG29	PG29	PG36
管规 Hose size	—	3/8"	3/8"	1/2"	3/4"	1"	1"	1 1/4"

护盖可选购尺寸见第93页 Optional cap size see P93

● 直式电缆护套插头: TQ Plug with PVC sleeve: TQ



尺寸 Dimension(mm)	WS16	WS20	WS24	WS28	WS32	WS40	WS48	WS55
∅D	21.5	26.4	29.8	34	39.3	49.3	57.2	64.5
L	44	49.5	53.5	56	70	75.5	85.5	97
∅d max	10	11.6	12.4	16	19.5	24	24	30

电缆护套尺寸见第93页 PVC sleeve dimension see P93

● 直式金属软管插头: TP Plug for metal-hose: TP



尺寸 Dimension(mm)	WS16	WS20	WS24	WS28	WS32	WS40	WS48	WS55
∅D1	21.5	26.4	29.8	34	39.3	49.3	57.2	64.5
L	48	57	58	61	74	82	90	100
管规 Hose size	1/4"	3/8"	3/8"	1/2"	3/4"	1"	I: 1" (不标) II: 1 1/4"	1 1/4"

● 直式塑料软管插头: TD Plug for plastic-hose: TD



塑料软管接头可选购
Optional plastic hose adapter

尺寸 Dimension(mm)	WS16	WS20	WS24	WS28	WS32	WS40	WS48	WS55
∅D	21.5	26	30	34	39.3	49.3	57.2	64.5
L	56	64.5	68.5	75	88.5	95.5	105	119
接头规格 Adapter size	PG7	PG11	PG11	PG16	PG21	PG29	I: PG29 (不标) II: PG36	PG36
管规 Hose size	1/4"	3/8"	3/8"	1/2"	3/4"	1"	I: 1" (不标) II: 1 1/4"	1 1/4"



● 弯式金属软管插头: TR Plug with angled back shell for metal-hose: TR

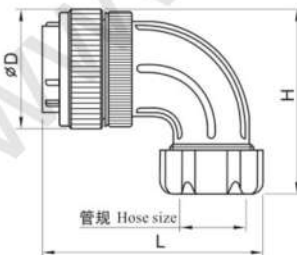

尺寸 Dimension(mm)		WS20	WS24	WS28	WS32	WS40	WS48	WS55
øD	—	25.6	30	33.8	38.2	49.3	55.8	63
H	—	48	51	52	58	70	82	90
L	—	60	60	63	81	88	96	107
管规 Hose size	—	3/8"	3/8"	1/2"	3/4"	1"	1"	1 1/4"

● 弯式双压板电缆插头: TS Plug with angled back shell with cable clamping plates: TS

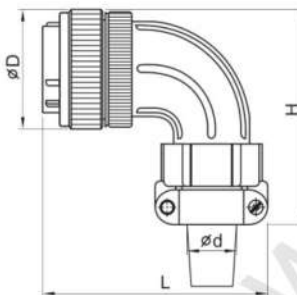

尺寸 Dimension(mm)		WS20	WS24	WS28	WS32	WS40	WS48	WS55
øD	—	27.3	30	33.8	38.2	49.3	55.8	63
H	—	53	57	61	66	78	91	100
L	—	60	61	64	80	88	96	107
ød max	—	11.6	12.4	15.7	19.5	24	24	30

电缆护套尺寸见第93页 PVC sleeve dimension see P93

● 弯式塑料软管插头: TC Plug with right angle back shell for plastic-hose: TC

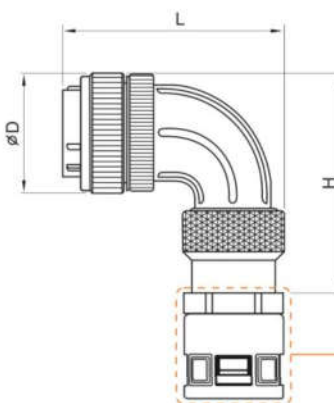

尺寸 Dimension(mm)		WS20	WS24	WS28	WS32	WS40	WS48	WS55
øD	—	27.5	31	35	39	49.3	57	65
H	—	57	62	65	71.5	82	96	107
L	—	59.5	60	63	80.5	88	94	112
接头规格 Adapter size	—	PG11	PG11	PG16	PG21	PG29	PG29	PG36
管规 Hose size	—	3/8"	3/8"	1/2"	3/4"	1"	1"	1 1/4"

Optional plastic hose adapter
塑料软管接头可选购

X-ON Electronics

Largest Supplier of Electrical and Electronic Components

Click to view similar products for [Standard Circular Connector](#) category:

Click to view products by [Weipu](#) manufacturer:

Other Similar products are found below :

[C015 10F006 001 1](#) [5M2530B10P](#) [600247N007](#) [600259N006](#) [600273N007](#) [600432N009](#) [6280-2PG-519](#) [6280-3PG-311](#) [6280-3SG-311](#)
[6280-7SG-3DC](#) [6280-7SG-522](#) [6282-5PG-311](#) [6282-6PG-519](#) [6282-8SG-311](#) [6283-11](#) [6283-15](#) [6290](#) [6293](#) [6382-2PG-311](#) [6382-2PG-3DC](#)
[6382-2SG-321](#) [6382-2SG-3DC](#) [6382-4SG-516](#) [67-03E20-37P](#) [681-PMG](#) [CXS3102A14S2P](#) [CXS3102A181S](#) [CXS3106A14S6S](#)
[D38999/20FC8SA L/C](#) [MB12P-1](#) [MB12R-6](#) [7251-2PG-300](#) [7251-2SG-300](#) [7251-4PG-300](#) [7251-4SG-300](#) [7251-5PG-300](#) [7251-5SG-300](#)
[7251-6SG-300](#) [7251-7PG-300](#) [7251-8PG-300](#) [7271-6SG-300](#) [7282-3PG-300-CH3](#) [73000005663](#) [75-190011-03P](#) [75-190216-08S](#) [75-190218-](#)
[10P](#) [75-214636-52P](#) [75-474118-10P](#) [75-474211-03P](#) [75-474218-19S](#)