

6003 Joker combination wrench, 14 x 167 mm

6003 Joker combination wrench

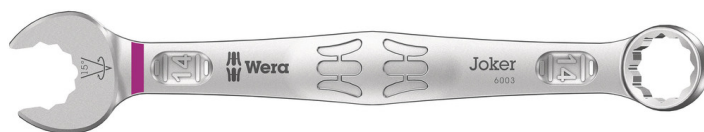

EAN:	4013288212702	Size:	249x50x23 mm
Part number:	05020205001	Weight:	93 g
Article number:	6003 Joker	Country of origin:	CZ
		Customs tariff number:	82041100

- Especially suitable for tight spaces
- The special mouth geometry expands the placement possibilities of the tool
- The low return angle in the mouth "takes" the screw every 15°
- Slim ring side angled by 15°
- With Take it easy tool finder: colour coding by size

As the installation space becomes increasingly tight during screwdriving, it remains necessary that tools enable users to work successfully. Narrow spaces require additional placement points of the tool. Can spanners be modified so that the placement possibilities of the tool increase? The combination of the 7.5° pivoted mouth and the double hexagon geometry doubles the placement points. A repeated 180° turn of the wrench around the longitudinal axis during screwdriving provides four placement possibilities, and bolts or screw heads can be "taken" every 15°. The Joker 6003 with its smart mouth geometry significantly expands the range of uses in confined spaces. The Joker 6003 will automatically find the respective placement point after every turn. The slim yet robust ring side is angled by 15° to the tool axis. The high-quality surface treatment achieves a high and long-lasting corrosion protection. With Take it easy tool finder: colour coding by size.

Web link

https://products.wera.de/en/joker_6003_joker_combination_wrench_open-end_with_return_angle_of_just_15_when_things_get_tight_6003_joker.html

Wera - 6003 Joker
05020205001 - 4013288212702

Wera Werkzeuge GmbH
Korzter Straße 21-25
D-42349 Wuppertal
Tel: +49 (0)2 02 / 40 45-0
E-Mail: info@wera.de

6003 Joker combination wrench

For very tight spaces



The Joker 6003 combination wrench with its special mouth geometry – an open-end offset by 7.5° and the double hexagon geometry – doubles the placement possibilities when repeatedly turning the wrench 180° around the longitudinal axis. Bolts and screw heads can be "accessed" every 15°. The Joker 6003 will automatically find the respective placement point after every turn.

For pivoting angles under 30°

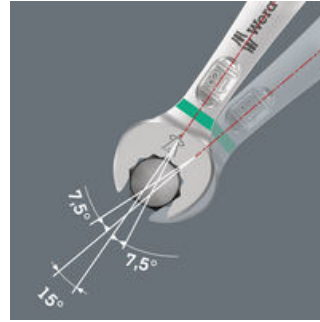

Thanks to the mouth side pivoted by 7.5°, double hexagon geometry and an adjusted application method (placement – screwdriving – turning – replacement – screwdriving – turning, etc), even screwdriving challenges allowing a pivoting angle of less than 30° can be solved.

Double-hex geometry



The double hexagon geometry on the mouth and ring sides secures the positive connection with the screw head or bolt and reduces the risk of slipping.

Angled ring side

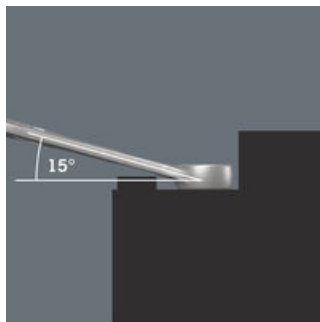

The ring side is angled at 15° to the tool axis to prevent injury.

“Take it easy” tool finder



Take it easy tool finder system - with profile and size colour-coding for quick and easy tool selection. Colour-coded system for hexagon drive screws (L-Keys, Zyklus bit sockets), external hex drive screws and nuts (Joker wrenches, Zyklus sockets and Zyklus bit sockets with holding function), and TORX® drive screws (L-Keys, Zyklus bit sockets).

Web link

https://products.wera.de/en/joker_6003_joker_combination_wrench_open-end_with_return_angle_of_just_15_when_things_get_tight_6003_joker.html







Wera - 6003 Joker
05020205001 - 4013288212702

Wera Werkzeuge GmbH
Korzter Straße 21-25
D-42349 Wuppertal
Tel: +49 (0)2 02 / 40 45-0
E-Mail: info@wera.de

6003 Joker combination wrench, 14 x 167 mm

6003 Joker combination wrench

Further versions in this product family:

							
		mm	mm	mm	mm	mm	mm
05020200001	leuchtpink	8	115	19	4.5	12.5	7
05020201001	leuchtgelb	10	125	22	5	15	7
05020202001	cyan	11	135	24.5	5	17	8
05020203001	schwarz	12	148	26	5.5	18	8.5
05020204001	tuerkis	13	160	27	6	19	8.5
05020205001	pink	14	167	29	6	20	8.5
05020206001	weiss	15	174	32	6	22	8.5
05020207001	violett	16	182	35	6.5	23	10
05020208001	rot	17	190	38	6.5	24.5	10
05020209001	leuchtgruen	18	210	39	7.5	26	11.5
05020210001	blau	19	230	42	7.5	27.5	11.5

Web link

https://products.wera.de/en/joker_6003_joker_combination_wrench_open-end_with_return_angle_of_just_15_when_things_get_tight_6003_joker.html

Wera - 6003 Joker
05020205001 - 4013288212702

Wera Werkzeuge GmbH
Korzter Straße 21-25
D-42349 Wuppertal
Tel: +49 (0)2 02 / 40 45-0
E-Mail: info@wera.de

X-ON Electronics

Largest Supplier of Electrical and Electronic Components

Click to view similar products for [Spanners](#) category:

Click to view products by [Wera](#) manufacturer:

Other Similar products are found below :

[74008](#) [1406504-3](#) [1406504-4](#) [1406504-5](#) [1725859-2](#) [9965](#) [1055267-1](#) [1-1406504-0](#) [TG70-24](#) [1055512-1](#) [1055276-1](#) [R282303020](#) [TOL-222901](#) [523200-4](#) [TOL-171801](#) [1490262-2](#) [9968](#) [1302340394](#) [AC24VS](#) [BT-BS-609WT](#) [BT-BS-610R](#) [BT-BS-610RT](#) [BT-ST-302D](#) [1031-27R](#) [1031-34R](#) [1060-29](#) [1061-24](#) [1067-10](#) [1067-27](#) [1067-32](#) [1071-48](#) [10F0-26P](#) [10F0-32P](#) [10F0-55P](#) [0-90-947](#) [0-90-949](#) [43032](#) [40080606](#)
[40082626](#) [40093232](#) [50184065](#) [58211008](#) [58211011](#) [58211013](#) [58211014](#) [58211015](#) [58211016](#) [58211019](#) [58214022](#) [58214024](#)