

The Catalogue



Content

Screwdrivers



| | |
|-----------------------------|-----------|
| Kraftform Stainless Steel | 20 |
| Kraftform Plus - Series 900 | 26 |
| Kraftform Plus - Series 300 | 32 |
| Kraftform Series Comfort | 52 |
| Wooden Handle Series | 58 |
| Flagdriver Series | 61 |
| Screwdriving Accessories | 62 |
| Kraftform Micro Series | 64 |
| 400 T-Handle Series | 74 |
| ESD Tools | 80 |

VDE Tools



| | |
|--|------------|
| Kraftform Stainless VDE | 88 |
| Kraftform 100 VDE | 92 |
| Kraftform Kompakt VDE | 106 |
| Kraftform Comfort VDE | 120 |
| The Zyklop VDE Ratchet and accessories | 124 |

Ratchets



| | |
|--------------------------|------------|
| 1/4" Zyklop Speed | 144 |
| 1/4" Zyklop Metal Push | 152 |
| 1/4" Zyklop Metal Switch | 154 |
| 1/4" Zyklop Accessories | 156 |
| 3/8" Zyklop Speed | 172 |
| 3/8" Zyklop Metal Push | 176 |
| 3/8" Zyklop Metal Switch | 178 |
| 3/8" Zyklop Accessories | 180 |
| 1/2" Zyklop Speed | 190 |
| 1/2" Zyklop Hybrid | 194 |
| 1/2" Zyklop Metal Push | 198 |
| 1/2" Zyklop Metal Switch | 200 |
| 1/2" Zyklop Accessories | 202 |
| 1/2" Koloss | 210 |
| Zyklop Mini 1 & 2 | 214 |

Joker Combination Ratchet Wrenches



| | |
|--|------------|
| Joker Ratcheting Combination Wrenches | 228 |
| Joker Switch Ratcheting Combination Wrenches | 230 |

L-Keys



| | |
|----------------------------------|------------|
| L-Keys for Hexagon Socket Screws | 238 |
| L-Keys for TORX® Screws | 250 |
| Offset Screwdrivers | 257 |

Kraftform Kompakt



| | |
|--|------------|
| Kraftform Kompakt 10, 12 | 262 |
| Kraftform Kompakt 20, 22, 25, 26, 28 | 264 |
| Kraftform Kompakt 40, 41 | 268 |
| Kraftform Kompakt 50 | 269 |
| Kraftform Kompakt 60, 62 | 270 |
| Kraftform Kompakt 70, 71 | 276 |
| Kraftform Kompakt 100 | 278 |
| Kraftform Kompakt User-Specific Sets | 280 |
| Bitholding Screwdrivers And Adaptors | 284 |
| Kraftform Kompakt Vario With Ratchet Function | 288 |
| Kraftform Kompakt Vario Without Ratchet Function | 292 |





















Wera 2go



| | |
|-------------------------------|------------|
| Wera 2go 1 Tool Carrier | 300 |
| Wera 2go 2 Tool Container | 300 |
| Wera 2go 3 Tool Box | 300 |
| Wera 2go 4 Tool Quiver | 300 |
| Wera 2go 5 Tool Carrier | 301 |
| Wera 2go 6 Shoulder Strap | 301 |
| Hook and Loop Fastener Strips | 303 |

Bits



| | | |
|--|--|------------|
|  | Bits For Phillips Screws | 316 |
|  | Bits For Pozidriv Screws | 338 |
|  | Bits For Plusminus Screws – Slotted/Phillips | 350 |
|  | Bits For Plusminus Screws – Slotted/Pozidriv | 351 |
|  | Bits For TORX® Screws | 352 |
|  | Bits For TORX® BO Screws | 366 |
|  | Bits For TORX PLUS® Screws | 368 |
|  | Bits For TORX PLUS® IPR Screws | 372 |
|  | Bits For ASSY® Screws | 375 |
|  | Bits For Slotted Screws Guide Sleeves | 376 |
|  | Bits For Hexagon Socket Screws | 380 |
|  | Bits For Hexagon Socket BO Screws | 387 |
|  | Bits For Square Socket Screws | 388 |
|  | Bits For TORQ-SET® Screws | 392 |
|  | Bits For TRI-WING® Screws | 395 |
|  | Bits For Multi-Point Screws | 396 |
|  | Bits For Hi-TORQUE Screws | 397 |
|  | Bits For Microstix® Screws | 398 |
|  | Bits For Spanner Screws | 400 |
|  | Nutsetters | 401 |
|  | Internal Thread Insertion Tool | 403 |

Holder and Adaptors



| | |
|--|------------|
| Impaktor Bit Holders | 410 |
| Rapidaptor Bit Holders | 414 |
| BiTorsion Bit Holders With Quick-Release Chuck | 418 |
| Universal Bit Holders With Quick-Release Chuck | 419 |
| Universal Bit Holders With Retaining Ring | 421 |
| Universal Bit Holders With Stainless Steel Sleeve | 422 |
| Universal Bit Holders With Copper Beryllium Sleeve | 424 |
| Bit Holders With adjustable Depth-Control Stop | 425 |
| Adaptors | 426 |

Bit Sets



| | |
|-----------------------------------|------------|
| Bit-Checks Impaktor | 434 |
| Bit-Checks Stainless | 438 |
| Bit-Checks / Bit-Safes BiTorsion | 440 |
| Bit-Checks Diamond | 444 |
| Bit-Checks / Bit-Safes Universal | 448 |
| Bit-Checks Wood | 458 |
| Bit-Checks Metal | 460 |
| Bit Sets For Special Applications | 461 |

Torque Tools



| | |
|--------------------------|------------|
| Series 7400 Adjustable | 470 |
| Series 7400 Pre-Set | 478 |
| Series Torque-indicators | 484 |
| Series Click-Torque | 490 |
| Series Insert Tools | 502 |

Impact Driver and Soft-faced Hammers





















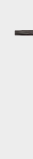
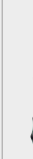













| | |
|---------------------|------------|
| Impact Driver 90 Nm | 510 |
| Soft Faced Hammers | 512 |

TechLex

| | |
|----------------------|------------|
| Technical Compendium | 516 |
| Code No. Index | 526 |
| Article No. Index | 540 |
| Alphabetical Index | 551 |

Tool Index

| Tool | Stainless | Series 900 | Series 300 | Series Comfort | Wooden Series | Micro Series | 400 T-Handle Series | VDE | ESD | Ratchets | L-Keys | Kraftform kompakt | Impact Drivers | Joker |
|---|---|---|---|---|---|---|---|---|--|---|---|---|---|---|
| Tip type |  |  |  |  |  |  |  |  |  |  |  |  |  |  |
| Phillips  | 22, 24, 25 | 28, 30 | 36, 45, 46, 48, 49, 50 | 54, 56 | 60 | 66, 70, 71, 72 | | 90, 91, 95, 96, 102 | 80, 81 | 144ff | 257 | 264ff | | |
| Pozidriv  | 22, 24, 25 | 29, 30, 31 | 36, 45, 46, 48, 49, 50 | 54, 56 | 60 | 66, 70 | | 90, 91, 95, 96, 102, 103 | 80 | 144ff | 257 | 264ff | | |
| PlusMinus Phillips  | | | | | | | | 97 | | | | | | |
| PlusMinus Pozidriv  | | | | | | | | 98, 102 | | | | | | |
| TORX® TORX® B0  | 23 | 29, 31 | 38, 39, 40, 45, 50, 51 | 55 | | 66, 67, 73 | 76 | 99, 102, 103 | 80 | 144ff | 250-256 | 264ff | | |
| TORX® ZA  | | | | | | | | | | | | | | |
| TORX PLUS®  | | | 40 | | | | | | | | | | | |
| TORX PLUS® IPR  | | | | | | 68, 72 | | | 80 | | | | | |
| ASSY®  | | | | | | | | | | | | | | |
| Slotted  | 22, 24, 25 | 28, 30, 31, 45, 46 | 34, 35, 45, 48, 49, 50 | 54, 56 | 60 | 66, 70, 71, 72 | | 45, 46, 90, 91, 94, 102 | 80, 81 | | 257 | 264ff | | |
| Hexagon Socket  | | | 38 | | | 68, 72 | 76 | | | 148ff | 238-249 | 270 | | |
| Hexagon Socket B0  | | | | | | | | | | | | | | |
| Square Socket  | 23 | | 41, 46, 51 | | | | | 100 | | | | 266, 271, 272 | | |
| TORQ-SET®  | | | 40 | | | | | | | | | 273, 276 | | |
| TRI-WING®  | | | 42 | | | | | | | | | 273, 276 | | |
| Multi-Point  | | | | | | | | | | | | | | |
| HTN  | | | | | | | | | | | | | | |
| Microstix®  | | | | | | 68 | | | 82 | | | | | |
| Spanner  | | | | | | | | | | | | 273, 276 | | |
| External Hex  | | | 42, 43, 51 | | | 69, 73 | 77 | 100, 126, 127 | 82 | 144ff | | | | 228-232 |

Your guide to getting the best tools for the job.

| | | | | | | | | | | | | | | Tool |
|--------------|---------|--------------|-------|------|-----|-----|-----|------|------|------|------|-------|--------------------|------|
| 1/4" | 5/16" | 1/4" | 7/16" | 4 mm | M4 | M5 | M6 | NF2A | 4 mm | 5 mm | 1/4" | 5/16" | Tip type | |
| 316-325 | 332 | 326-331 | | 335 | 333 | 333 | 334 | 334 | 335 | 336 | 332 | 336 | Phillips | |
| 338-343 | 348 | 344-348 | | | 348 | 349 | 349 | | | | | | Pozidriv | |
| | | 350 | | | | | | | | | | | PlusMinus Phillips | |
| | | 350 | | | | | | | | | | | PlusMinus Pozidriv | |
| 352-357, 366 | 361 | 358-360, 367 | | 364 | 362 | 362 | 363 | 363 | 364 | 365 | | | TORX® TORX® BO | |
| | | | | | | | | | | | | | TORX® ZA | |
| | | | | 370 | | | | | 370 | 370 | | | TORX PLUS® | |
| 372 | | 369, 373 | | 373 | | | | | 373 | | | | TORX PLUS® IPR | |
| 375 | | | | | | | | | | | | | ASSY® | |
| 376-377 | 379 | 378 | | | | | | | | | | | Slotted | |
| 380-381 | 385 | 382-384 | | 386 | | | | | | | | | Hexagon Socket | |
| 387 | | 387 | | | | | | | | | | | Hexagon Socket BO | |
| 388-389 | 390-391 | | | | | | | | | | | | Square Socket | |
| 392 | 394 | 393 | 394 | | | | | | | | | | TORQ-SET® | |
| 395 | 395 | 395 | | | | | | | | | | | TRI-WING® | |
| 396 | | 396 | | | | | | | | | | | Multi-Point | |
| 397 | | | | | | | | | | | | | HTN | |
| | | | | 398 | | | | | 398 | | | | Microstix® | |
| 400 | | 400 | | | | | | | | | | | Spanner | |
| | | 401,402 | | | | | | | 402 | | | | External Hex | |

WAKA

BE A

TOOL

REBEL



What we believe in ...

We believe in challenging the standard

We believe in thinking in a rebellious way

We believe in Rock'n'Roll

We love to be Tool Rebels

The way we challenge the standard is ...

by making the experience for our users ...

easier, safer and full of joy.

We simply create great tools for rebels.

BE A TOOL REBEL



Wera Tools

Passionate staff and a considerable degree of vertical manufacturing integration ensure an unmatched level of tool know-how.



Logistics Center Wera Werkzeuge GmbH, Wuppertal





Production plant, Wera Werk Bystřice



Great Tools for Rebels

Kraftform Micro

Precision engineering made easy.



BiTorsion

Bits and holder live longer.



Zyklop Mini

Whenever space is tight.

Kraftform Kompakt

Big content, small size.



Kraftform

Ergonomics you can grasp.



The Chiseldriver

More than just screwdriving.



Zyklus Speed

A really fast mover.

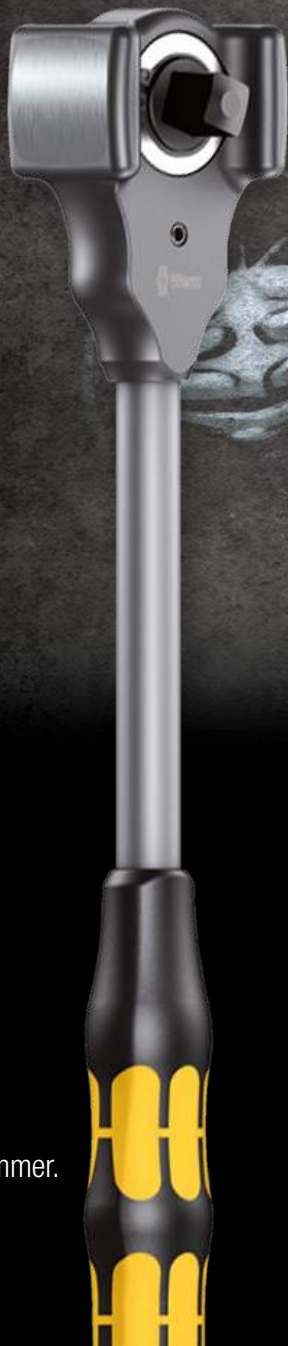

Koloss

Ratchet and hammer.



Lasertip

No more slips when screwdriving.

Joker

With an amazing holding function.



Great Tools for Rebels

Bit-Check

Everything at a glance. Always to hand.

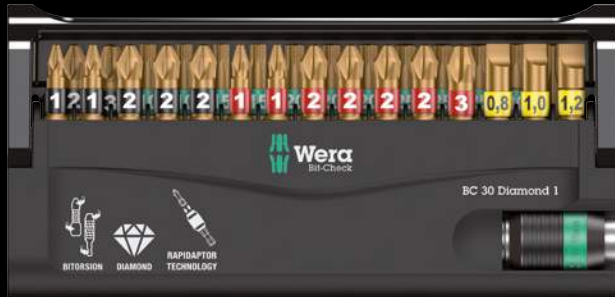

Tools in textile boxes

Small size and low weight for simpler mobility.



Rapidaptor

More rapid bit change.

Kraftform Kompakt 20

Getting a handle on things.

Diamond-coated Bits

Bits with "bite".

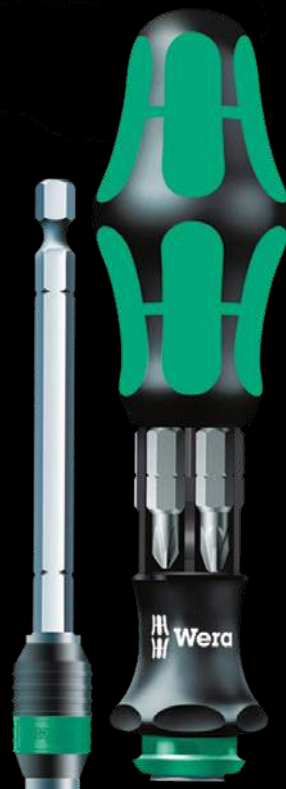

Impaktor Bits

For extreme situations.



Hex-Plus

Allows hexagon socket screws
a longer service life.



Tools with holding function

Secure holding of screws.



Stainless tools

Attractive and hard.

“Take it easy” Tool finder

Rapid access to the tool thanks
to colour coding.

Great Tools for Rebels



Zyklop VDE
The Zyklop ratchet now in an insulated version.



Wera Belts
Storage of sockets completely revolutionised.



Click-Torque wrenches

The new generation of Wera torque wrenches.



Wera 2go

The space-saving wonder for mobile applications.

We love design

Wera has received several awards for the design of its products and packaging. Including: Red Dot Award, iF Gold Award, German Design Award and German Brand Award Gold.



” Our DNA “











We love Rock'n'Roll







Screwdrivers

| | | |
|---|-----------------------------|-----------|
|  | Kraftform Stainless Steel | 20 |
|  | Kraftform Plus - Series 900 | 26 |
|  | Kraftform Plus - Series 300 | 32 |
|  | Kraftform Series Comfort | 52 |
|  | Wooden Handle Series | 58 |
|  | Flagdriver Series | 61 |
|  | Screwdriving Accessories | 62 |
|  | Kraftform Micro Series | 64 |
|  | 400 T-Handle Series | 74 |
|  | ESD Tools | 80 |

Kraftform Stainless Screwdrivers

Why are stainless elements so often affected by rust?

One reason: screwdriving jobs are often carried out with a tool made of conventional steel which can result in extraneous rust forming. This is annoying. We were confident that this could be prevented by using tools likewise out of stainless steel and meeting the required standard of industrial hardness.

A tool series out of stainless steel. The forming of extraneous rust is prevented and a special vacuum ice-hardening process ensures the required degree of hardness.



Solution to the rust problem: screw stainless steel together with stainless steel! Wera stainless steel tools are manufactured out of stainless steel so unsightly rust can be avoided.

The stainless steel tools from Wera are vacuum ice-hardened and have the hardness and strength needed for screw connections. There are no limitations to the industrial applications they are suitable for.



A precisely-focused laser creates a sharp-edged surface structure. This laser treatment results in an edge hardness of up to 1000 HV 0.3. Wera Lasertip "bites" itself into the screw head and prevents any slips out of the recess. It is available for screwdrivers for slotted, Phillips and Pozidriv screws.



Wera Lasertip reduces the contact pressure required and enhances force transfer – meaning less screwdriving effort is required. Screwdriving becomes safer and easier.



The outstanding design of the Kraftform handle that fits perfectly into the hand prevents hand injuries such as blisters and calluses.



The hard materials used for the handle ensure rapid hand repositioning without any danger of the skin “sticking” to the handle. The surrounding hard zones with large diameters glide like wheels across the hand.

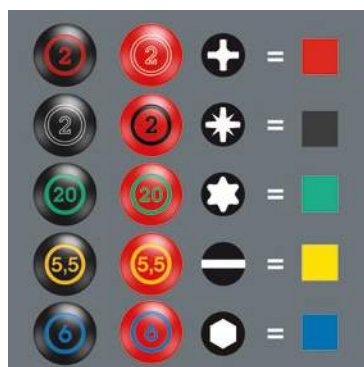

“Take it easy” tool finder: colour coding according to profile and size stamp. This enables faster and more reliable selection of the correct tool from the tool case.

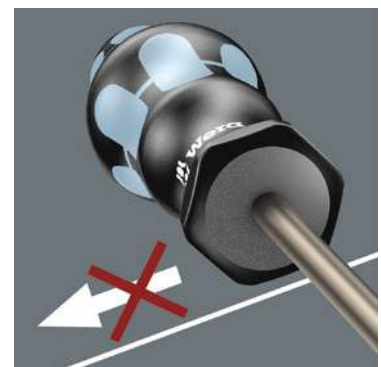

The hexagonal non-roll feature prevents any rolling away at the workplace.

Series Kraftform Screwdrivers Stainless Steel

3335 Screwdriver for slotted screws, stainless



Application: Slotted screws

Blade: Round

Design: Stainless steel for minimising rust, Lasertip

Handle: Kraftform with non-roll feature, multi-component. "Take it easy" tool finder: colour coding according to profile (yellow = slotted) and size stamp.

| | ┘ mm | ┘ mm | ∅ mm | ┘ mm | ┘ mm | ┘ " | ┘ " |
|---------------------------|---------|---------|---------|---------|---------|--------|--------|
| 05032001001 ¹⁾ | 0,5 | 3,0 | 3,0 | 80 | 81 | 1/8" | 3 1/8" |
| 05032002001 | 0,6 | 3,5 | 3,5 | 100 | 81 | 9/64" | 4" |
| 05032003001 | 0,8 | 4,0 | 4,0 | 100 | 98 | 5/32" | 4" |
| 05032004001 | 1,0 | 5,5 | 5,5 | 125 | 98 | 7/32" | 5" |

¹⁾ without Lasertip

3350 PH Screwdriver for Phillips screws, stainless



Application: Phillips screws

Blade: Round

Design: Stainless steel for minimising rust, Lasertip

Handle: Kraftform with non-roll feature, multi-component. "Take it easy" tool finder: colour coding according to profile (red = Phillips) and size stamp.

| | + | ┘ mm | ┘ mm | ∅ mm | ┘ " |
|---------------------------|------|---------|---------|---------|--------|
| 05032020001 ¹⁾ | PH 0 | 60 | 81 | 3,0 | 2 3/8" |
| 05032021001 | PH 1 | 80 | 98 | 4,5 | 3 1/8" |
| 05032022001 | PH 2 | 100 | 105 | 6,0 | 4" |
| 05032023001 | PH 3 | 150 | 112 | 8,0 | 6" |

¹⁾ without Lasertip

3334 Screwdriver for slotted screws, stainless



Application: Slotted screws

Blade: Round

Design: Lasertip, stainless steel for minimising rust,

Handle: Kraftform with non-roll feature, multi-component. "Take it easy" tool finder: colour coding according to profile (yellow = slotted) and size stamp.

| | ┘ mm | ┘ mm | ∅ mm | ┘ mm | ┘ mm | ┘ " | ┘ " |
|-------------|---------|---------|---------|---------|---------|--------|--------|
| 05032005001 | 1,2 | 6,5 | 6,0 | 150 | 105 | 1/4" | 6" |
| 05032006001 | 1,2 | 8,0 | 7,0 | 175 | 112 | 5/16" | 7" |
| 05032007001 | 1,6 | 10,0 | 9,0 | 200 | 112 | 3/8" | 8" |

3355 PZ Screwdriver for Pozidriv screws, stainless



Application: Suitable for Pozidriv screws

Blade: Round

Design: Stainless steel for minimising rust, Lasertip

Handle: Kraftform with non-roll feature, multi-component. "Take it easy" tool finder: colour coding according to profile (black = Pozidriv) and size stamp.

| | ✦ | ┘ mm | ┘ mm | ∅ mm | ┘ " |
|---------------------------|------|---------|---------|---------|--------|
| 05032030001 ¹⁾ | PZ 0 | 60 | 81 | 3,0 | 2 3/8" |
| 05032031001 | PZ 1 | 80 | 98 | 4,5 | 3 1/8" |
| 05032032001 | PZ 2 | 100 | 105 | 6,0 | 4" |
| 05032033001 | PZ 3 | 150 | 112 | 8,0 | 6" |

¹⁾ without Lasertip



3367 Screwdriver for TORX® screws, stainless



Application: TORX® socket screws
Blade: Round
Design: Stainless steel for minimising rust
Handle: Kraftform with non-roll feature, multi-component. "Take it easy" tool finder: colour coding according to profile (green = TORX®) and size stamp.

| | | mm | mm | mm | mm |
|-------------|-------|-----|-----|-----|---------|
| 05032050001 | TX 8 | 60 | 81 | 3,5 | 2 3/8" |
| 05032051001 | TX 9 | 60 | 81 | 4,0 | 2 3/8" |
| 05032052001 | TX 10 | 80 | 81 | 4,0 | 3 1/8" |
| 05032053001 | TX 15 | 80 | 98 | 4,0 | 3 1/8" |
| 05032054001 | TX 20 | 100 | 98 | 4,5 | 4" |
| 05032055001 | TX 25 | 100 | 105 | 5,0 | 4" |
| 05032056001 | TX 27 | 115 | 105 | 5,5 | 4 9/16" |
| 05032057001 | TX 30 | 115 | 105 | 6,0 | 4 9/16" |
| 05032058001 | TX 40 | 130 | 112 | 7,0 | 5 3/16" |

3368 Screwdriver for square socket screws, stainless



Application: Square socket screws
Blade: Round
Design: Stainless steel for minimising rust
Handle: Kraftform with non-roll feature, multi-component

| | | mm | mm | mm | mm |
|-------------|-----|-----|-----|-----|--------|
| 05032070002 | # 1 | 80 | 98 | 4,5 | 3 1/8" |
| 05032071002 | # 2 | 100 | 105 | 6,0 | 4" |

Tip



Screwdrivers "Take it easy"

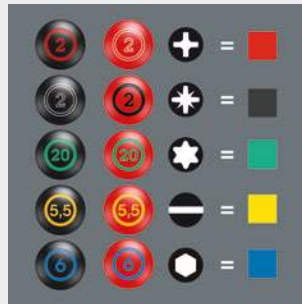

"Take it easy" tool finder: colour coding according to profile and size stamp. This enables faster and more reliable selection of the correct tool from the tool case.



How to prevent the screwdriver from slipping out of the screw head?



It happens time and time again that the tip slips out of the screw head when screwdriving, sometimes damaging valuable surfaces or even causing injury. The tips of the Wera Lasertip screwdrivers are microscopically roughened by means of a laser. This rough surface literally "bites" itself firmly into the screw head. Slipping out becomes a thing of the past.

Vacuum ice-hardened



The stainless steel tools from Wera are vacuum ice-hardened and have the hardness and strength needed for screw connections. There are no limitations to the industrial applications they are suitable for.

Series Kraftform Screwdrivers Stainless Steel

3334/6 Screwdriver set, stainless and rack



Application: Slotted and Phillips screws

Content: 6-piece set with "Take it easy" tool finder: colour coding according to profile and size stamp and rack in display carton

| | | |
|-------------|---------|--|
| | | |
| 05032060001 | | |
| | 3350 PH | 1 x PH 1x80; 1 x PH 2x100 |
| | 3335 | 1 x 0,5x3,0x80 ¹⁾ ; 1 x 0,8x4,0x100; 1 x 1,0x5,5x125 |
| | 3334 | 1 x 1,2x6,5x150 |

¹⁾ without Lasertip

3334/3355/6 Screwdriver set, stainless and rack



Application: Slotted and Pozidriv screws

Content: 6-piece set with "Take it easy" tool finder: colour coding according to profile and size stamp and rack in display carton

| | | |
|-------------|---------|--|
| | | |
| 05032061001 | | |
| | 3355 PZ | 1 x PZ 1x80; 1 x PZ 2x100 |
| | 3335 | 1 x 0,5x3,0x80 ¹⁾ ; 1 x 0,8x4,0x100; 1 x 1,0x5,5x125 |
| | 3334 | 1 x 1,2x6,5x150 |

¹⁾ without Lasertip



3334/3350/3355/6 Screwdriver set, stainless and rack



Application: Slotted, Phillips and Pozidriv screws

Content: 6-piece set with "Take it easy" tool finder: colour coding according to profile and size stamp and rack in display carton

| | | |
|-------------|---------|------------------------------|
| | | |
| 05032063001 | | |
| | 3350 PH | 1 x PH 1x80; 1 x PH 2x100 |
| | 3355 PZ | 1 x PZ 1x80; 1 x PZ 2x100 |
| | 3335 | 1 x 0,5x3,0x80 ¹⁾ |
| | 3334 | 1 x 1,2x6,5x150 |

¹⁾ without Lasertip

Tip



Screwdrivers "Take it easy"

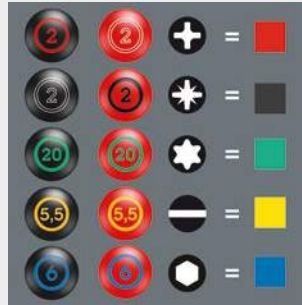

"Take it easy" tool finder: colour coding according to profile and size stamp. This enables faster and more reliable selection of the correct tool from the tool case.



Kraftform



The outstanding design of the Kraftform handle that fits perfectly into the hand prevents hand injuries such as blisters and calluses.



Non-roll feature

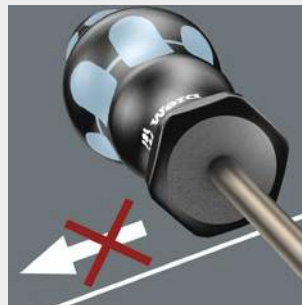

The hexagonal non-roll feature prevents any rolling away at the workplace.

Series 900 – the Chiseldriver

Screwdrivers are often misused as chisels. This can be dangerous.

The chiseldriver is the solution when not only screwdriving is required. For fastening, chiselling and loosening seized screws.

Wera chiseldriver: the screwdriver whenever the going gets tough!



An integrated impact cap lengthens the service life and reduces the danger of splintering. Nevertheless, always wear protective goggles.



Greater torque can be transferred by fitting an open-jaw or ring spanner over the integrated hex bolster.



The hard materials used for the handle ensure rapid hand repositioning without any danger of the skin “sticking” to the handle. The softer “anti-slip” zones provide increased grip, enabling the low-loss transfer of high forces.



A hexagon blade made out of high-quality bit material extends right through the handle – thereby ensuring full transfer of force, even when struck with a hammer. The ductile tempered material prevents the blade from splintering or breaking.



The outstanding design of the Kraftform handle that fits perfectly into the hand. Prevents hand injuries such as blisters and calluses. Wera Kraftform: a synonym for “graspable” ergonomics!

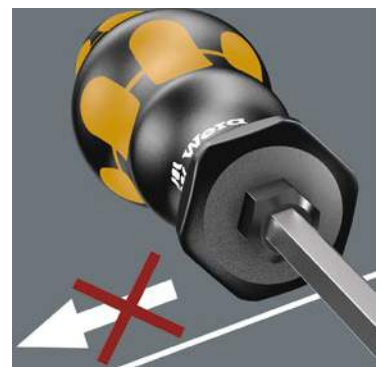

The hexagonal non-roll feature prevents any annoying rolling away at the workplace.



Kraftform Plus – Series 900

The chiseldriver for fastening and chiselling

932 A Screwdriver for slotted screws



Application: Slotted screws
Blade: Hexagonal throughout with impact cap, hexagonal bolster from 0.8 x 4.5
Design: Chrome-plated, Black Point
Handle: Kraftform with non-roll feature, multi-component, sizes 2.0 x 12.0, 2.5 x 14.0: Kraftform with non-roll feature, single-component

| | mm | mm | mm | mm | mm | mm | mm |
|---------------------------|-----|------|----|----|-----|-----|---------------|
| 05018260001 ¹⁾ | 0,6 | 3,5 | 4 | | 80 | 81 | 9/64" 3 1/8" |
| 05018262001 | 0,8 | 4,5 | 5 | 8 | 90 | 98 | 0,178" 3 1/2" |
| 05018264001 | 1,0 | 5,5 | 6 | 10 | 100 | 105 | 7/32" 4" |
| 05018266001 | 1,2 | 7,0 | 6 | 10 | 125 | 105 | 9/32" 5" |
| 05018268001 | 1,6 | 9,0 | 8 | 13 | 150 | 112 | 11/32" 6" |
| 05018270001 | 1,6 | 10,0 | 8 | 13 | 175 | 112 | 3/8" 7" |
| 05018272001 | 2,0 | 12,0 | 10 | 16 | 200 | 117 | 1/2" 8" |
| 05018274001 | 2,5 | 14,0 | 10 | 16 | 250 | 117 | 9/16" 10" |

¹⁾ No throughout blade, no impact cap and no hexagon bolster

932 A SB Screwdriver for slotted screws

| | | 4013288 |
|-------------|-----------------|---------|
| 05100085001 | 1 x 1.0x5.5x100 | 181596 |
| 05100086001 | 1 x 1.2x7.0x125 | 181602 |
| 05100087001 | 1 x 1.6x9.0x150 | 181619 |



917 SPHS Screwdriver for Phillips screws



Application: Phillips screws
Blade: Hexagonal throughout, impact cap with integrated square socket for insertion of 1/4" blades for higher torque
Design: Chrome-plated, Black Point
Handle: Kraftform with non-roll feature, multi-component

| | | mm | mm | mm | mm | mm |
|-------------|------|----|----|-----|-----|----------|
| 05017040001 | PH 1 | 5 | 8 | 90 | 98 | 3 35/64" |
| 05017041001 | PH 2 | 6 | 10 | 113 | 105 | 4 29/64" |

932 AS Screwdriver for slotted screws



Application: Slotted screws
Blade: Hexagonal throughout, impact cap with integrated square socket for insertion of 1/4" blades for higher torque, hexagonal bolster
Design: Chrome-plated, Black Point
Handle: Kraftform with non-roll feature, multi-component

| | mm | mm | mm | mm | mm | mm | mm |
|-------------|-----|-----|----|----|-----|-----|----------------|
| 05018300001 | 0,8 | 4,5 | 5 | 8 | 100 | 98 | 0,178" 4 3/64" |
| 05018301001 | 1,0 | 5,5 | 6 | 10 | 113 | 105 | 7/32" 4 1/16" |
| 05018302001 | 1,2 | 7,0 | 6 | 10 | 138 | 105 | 9/32" 5 7/16" |

917 SPH Screwdriver for Phillips screws



Application: Phillips screws
Blade: Hexagonal throughout with impact cap, hexagonal bolster for sizes 1 - 4
Design: Chrome-plated, Black Point
Handle: Kraftform with non-roll feature, multi-component, size 4/200: Kraftform with non-roll feature, single-component

| | | mm | mm | mm | mm | mm |
|-------------|------|----|----|-----|-----|--------|
| 05017005001 | PH 1 | 5 | 8 | 80 | 98 | 3 1/8" |
| 05017010001 | PH 2 | 6 | 10 | 100 | 105 | 4" |
| 05017015001 | PH 3 | 8 | 13 | 150 | 112 | 6" |
| 05017020001 | PH 4 | 10 | 16 | 200 | 117 | 8" |

917 SPH SB Screwdriver for Phillips screws

| | | 4013288 |
|-------------|--------------|---------|
| 05100075001 | 1 x PH 1x80 | 181565 |
| 05100076001 | 1 x PH 2x100 | 181572 |
| 05100077001 | 1 x PH 3x150 | 181589 |





918 SPZ Screwdriver for Pozidriv screws



- Application:** Suitable for Pozidriv screws
- Blade:** Hexagonal throughout with impact cap, hexagonal bolster for sizes 1 - 4
- Design:** Chrome-plated, Black Point
- Handle:** Kraftform with non-roll feature, multi-component, size 4/200: Kraftform with non-roll feature, single-component

| | | mm | mm | mm | mm | |
|-------------|------|----|----|-----|-----|--------|
| 05017050001 | PZ 1 | 5 | 8 | 80 | 98 | 3 1/8" |
| 05017052001 | PZ 2 | 6 | 10 | 100 | 105 | 4" |
| 05017054001 | PZ 3 | 8 | 13 | 150 | 112 | 6" |
| 05017056001 | PZ 4 | 10 | 16 | 200 | 117 | 8" |

918 SPZ SB Screwdriver for Pozidriv screws

| | | | 4013288 |
|-------------|---|--------------|---------|
| 05100080001 | ⊕ | 1 x PZ 1x80 | 181633 |
| 05100081001 | ⊕ | 1 x PZ 2x100 | 181640 |
| 05100082001 | ⊕ | 1 x PZ 3x150 | 181657 |



977 Screwdriver for TORX® screws



- Application:** TORX® socket screws
- Blade:** Hexagonal throughout with impact cap, hexagonal bolster
- Design:** Chrome-plated, Black Point
- Handle:** Kraftform with non-roll feature, multi-component

| | | mm | mm | mm | mm | |
|-------------|-------|----|----|-----|-----|--------|
| 05024400001 | TX 15 | 5 | 8 | 80 | 98 | 3 1/8" |
| 05024401001 | TX 20 | 5 | 8 | 90 | 98 | 3 1/2" |
| 05024402001 | TX 25 | 6 | 10 | 100 | 105 | 4" |
| 05024403001 | TX 27 | 6 | 10 | 125 | 105 | 5" |
| 05024404001 | TX 30 | 8 | 13 | 150 | 112 | 6" |
| 05024405001 | TX 40 | 8 | 13 | 150 | 112 | 6" |

Tip



Why is the Kraftform Plus handle made from several components?



Wera makes its Kraftform handles from several materials with different properties. The core is made from a hardwearing plastic that holds the blade securely even when subjected to great forces. The yellow soft zones of the external mantle consist of a softer material with more friction resistance for high torque transfer. The black areas with a harder surface prevent the hand from sticking to the handle enabling you to adjust your grip more quickly.

Wera makes its Kraftform handles from several materials with different properties. The core is made from a hardwearing plastic that holds the blade securely even when subjected to great forces. The yellow soft zones of the external mantle consist of a softer material with more friction resistance for high torque transfer. The black areas with a harder surface prevent the hand from sticking to the handle enabling you to adjust your grip more quickly.



Wera Black Point tip



The Wera Black Point tip and a refined hardening process ensure long service life of the tip, improved corrosion protection and an exact fit.



Impact cap with integrated square socket



Even higher torque can be transferred by connecting the square drive version to a T-handle or Zyklop ratchet.

Kraftform Plus – Series 900

The chiseldriver for fastening and chiselling

Big Pack 900 Screwdriver set Kraftform Wera: Chiseldriver and rack



Application: Slotted, Phillips, Pozidriv and TORX® socket screws

Content: 13-piece set

| | |
|-------------|--|
| 05133285001 | |
| + | 917 SPH 1 x PH 1x80; 1 x PH 2x100; 1 x PH 3x150 |
| + | 918 SPZ 1 x PZ 1x80; 1 x PZ 2x100; 1 x PZ 3x150 |
| - | 932 A 1 x 0,6x3,5x80 ¹⁾ ; 1 x 0,8x4,5x90; 1 x 1,0x5,5x100; 1 x 1,2x7,0x125; 1 x 1,6x9,0x150 |
| T | 977 TORX® 1 x TX 20x90; 1 x TX 25x100 |
| | Rack 2 x 190,0x50,0 |

¹⁾ No throughout blade, no impact cap and no hexagon bolster

932 S/6 Screwdriver set Kraftform Wera: Chiseldriver and rack



Application: Slotted and Phillips screws, impact cap with integrated square socket for insertion of 1/4" blades for higher torque

Content: 6-piece set and rack in display carton

| | |
|-------------|---|
| 05018283001 | |
| + | 917 SPHS 1 x PH 1x90; 1 x PH 2x113 |
| - | 932 A 1 x 0,6x3,5x80 ¹⁾ |
| - | 932 AS 1 x 0,8x4,5x100; 1 x 1,0x5,5x103; 1 x 1,2x7,0x138 |

¹⁾ No throughout blade, no impact cap and no hexagon bolster

932/6 Screwdriver set Kraftform Wera: Chiseldriver and rack



Application: Slotted and Phillips screws

Content: 6-piece set and rack in display carton

| | |
|-------------|--|
| 05018282001 | |
| + | 917 SPH 1 x PH 1x80; 1 x PH 2x100 |
| - | 932 A 1 x 0,6x3,5x80 ¹⁾ ; 1 x 0,8x4,5x90; 1 x 1,0x5,5x100; 1 x 1,2x7,0x125 |

¹⁾ No throughout blade, no impact cap and no hexagon bolster



**932/918/6 Screwdriver set Kraftform Wera:
Chiseldriver and rack**



Application: Slotted and Pozidriv screws
Content: 6-piece set and rack in display carton

| | |
|-------------|--|
| 05018287001 | |
| + | 918 SPZ 1 x PZ 1x80; 1 x PZ 2x100 |
| - | 932 A 1 x 0,6x3,5x80 ¹⁾ ; 1 x 0,8x4,5x90; 1 x 1,0x5,5x100; 1 x 1,2x7,0x125 |

¹⁾ No throughout blade, no impact cap and no hexagon bolster

**977/6 TORX® Screwdriver set Kraftform Wera:
Chiseldriver and rack**



Application: TORX®
Content: 6-piece set and rack in display carton

| | |
|-------------|---|
| 05024410001 | |
| + | 977 TORX® 1 x TX 15x80; 1 x TX 20x90; 1 x TX 25x100; 1 x TX 27x125; 1 x TX 30x150; 1 x TX 40x150 |



Kraftform Screwdrivers

Series 300

Kraftform Plus screwdrivers – ergonomics you can grasp. They relieve the entire hand-arm system even when used intensively.

Along with other technical and product advantages such as the Lasertip for a secure fit in the screw head, Kraftform screwdrivers are the ideal choice whenever manual screwdriving jobs are concerned.



The outstanding design of the Kraftform handle that fits perfectly into the hand prevents hand injuries such as blisters and calluses.

The hard materials used for the handle ensure rapid hand repositioning without any danger of the skin “sticking” to the handle. The surrounding hard zones with large diameters glide like wheels across the hand.



The basic idea for the prototype of the Kraftform handle – that the hand should dictate the design – has, right through to today, proved to be correct. In cooperation with the internationally recognised Fraunhofer IAO Institute, Wera developed a screwdriver handle designed to match the shape of the human hand as long ago as the 1960s. After a long development phase, the Wera Kraftform handle was launched to the market in 1968. It has been optimised through the years with new technologies, but has kept its proven shape. After all, the human hand has not changed either.



The large contact area – with particularly high friction to the soft zones – results in high torque transfer without any bruising from the edges.



A precisely-focused laser creates a sharp-edged surface structure. This laser treatment results in an edge hardness of up to 1000 HV 0.3. Wera Lasertip “bites” itself into the screw head and prevents any slips out of the recess. It is available for screwdrivers for slotted, Phillips and Pozidriv screws.



Wera Lasertip reduces the contact pressure required and enhances force transfer – meaning less screwdriving effort is required. Screwdriving becomes safer and easier.

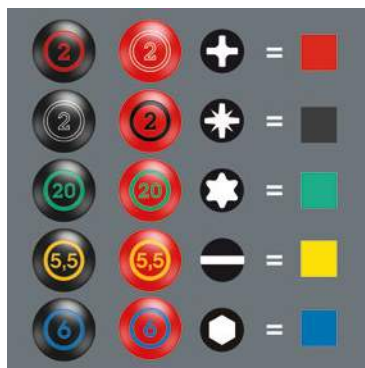

“Take it easy” tool finder: colour coding according to profile and size stamp. This enables faster and more reliable selection of the correct tool from the tool case.

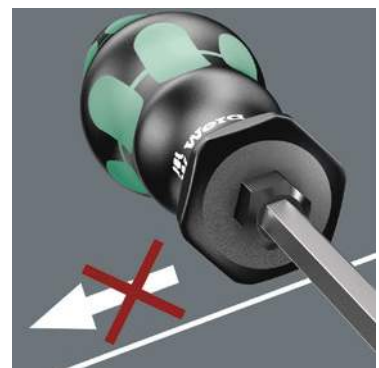

The hexagonal non-roll feature prevents any rolling away at the workplace.

Kraftform Plus – Series 300

The answer to almost every screw.

335 Screwdriver for slotted screws



Application: Slotted screws

Blade: Round

Design: Chrome-plated, Lasertip

Handle: Kraftform with non-roll feature, multi-component. "Take it easy" tool finder: colour coding according to profile (yellow = slotted) and size stamp.

| | mm | mm | mm | mm | mm | mm | mm |
|---------------------------|-----|-----|-----|-----|-----|-------|--------|
| 05008006001 ¹⁾ | 0,4 | 2,0 | 60 | 70 | 2,5 | 5/64" | 2 3/8" |
| 05110000001 ¹⁾ | 0,4 | 2,5 | 60 | 70 | 2,5 | 3/32" | 2 3/8" |
| 05008007001 ¹⁾ | 0,4 | 2,5 | 75 | 70 | 2,5 | 3/32" | 3" |
| 05008008001 ¹⁾ | 0,5 | 3,0 | 150 | 81 | 4,0 | 1/8" | 6" |
| 05008009001 ¹⁾ | 0,5 | 3,0 | 200 | 81 | 4,0 | 1/8" | 8" |
| 05110001001 ¹⁾ | 0,5 | 3,0 | 80 | 81 | 3,0 | 1/8" | 3 1/8" |
| 05008015001 | 0,6 | 3,5 | 100 | 81 | 3,5 | 9/64" | 4" |
| 05110002001 | 0,6 | 3,5 | 125 | 81 | 3,5 | 9/64" | 5" |
| 05110003001 | 0,6 | 3,5 | 200 | 81 | 3,5 | 9/64" | 8" |
| 05110004001 | 0,8 | 4,0 | 100 | 98 | 4,0 | 5/32" | 4" |
| 05110005001 | 0,8 | 4,0 | 150 | 98 | 4,0 | 5/32" | 6" |
| 05110006001 | 0,8 | 4,0 | 200 | 98 | 4,0 | 5/32" | 8" |
| 05008027001 ¹⁾ | 0,8 | 4,0 | 300 | 98 | 4,0 | 5/32" | 12" |
| 05110007001 | 1,0 | 5,5 | 125 | 98 | 5,5 | 7/32" | 5" |
| 05008055001 | 1,0 | 5,5 | 150 | 98 | 5,5 | 7/32" | 6" |
| 05110008001 | 1,0 | 5,5 | 200 | 98 | 5,5 | 7/32" | 8" |
| 05008060001 ¹⁾ | 1,0 | 5,5 | 300 | 98 | 5,5 | 7/32" | 12" |
| 05008061001 | 1,2 | 6,0 | 100 | 105 | 6,0 | 5/16" | 4" |

¹⁾ without Lasertip

335 SB Slotted screwdriver

| | | 4013288 |
|-------------|-------------------|---------|
| 05100042001 | ● 1 x 0.6x3.5x100 | 181275 |
| 05100043001 | ● 1 x 0.8x4.0x100 | 181251 |
| 05100044001 | ● 1 x 1.0x5.5x125 | 181244 |



334 SK Screwdriver for slotted screws



Application: Slotted screws

Blade: Hexagonal with bolster from 0.8 x 4.5

Design: Chrome-plated, Lasertip

Handle: Kraftform with non-roll feature, multi-component. "Take it easy" tool finder: colour coding according to profile (yellow = slotted) and size stamp.

| | mm | mm | mm | mm | mm | mm | mm | |
|-------------|-----|------|----|----|-----|-----|--------|--------|
| 05007670001 | 0,6 | 3,5 | 4 | - | 75 | 81 | 9/64" | 3" |
| 05007671001 | 0,8 | 4,0 | 4 | - | 90 | 81 | 5/32" | 3 1/2" |
| 05007672001 | 0,8 | 4,5 | 5 | 8 | 90 | 98 | 0,178" | 3 1/2" |
| 05007673001 | 1,0 | 5,5 | 6 | 10 | 100 | 98 | 7/32" | 4" |
| 05007674001 | 1,2 | 6,5 | 6 | 10 | 125 | 105 | 1/4" | 5" |
| 05007675001 | 1,2 | 7,0 | 6 | 10 | 125 | 105 | 9/32" | 5" |
| 05007676001 | 1,6 | 9,0 | 8 | 13 | 150 | 112 | 11/32" | 6" |
| 05007677001 | 1,6 | 10,0 | 8 | 13 | 175 | 112 | 3/8" | 7" |

334 Screwdriver for slotted screws



Application: Slotted screws

Blade: Round

Design: Chrome-plated, Lasertip

Handle: Kraftform with non-roll feature, multi-component, sizes 2.0 x 12.0, 2.5 x 14.0: Kraftform with non-roll feature, single-component. "Take it easy" tool finder: colour coding according to profile (yellow = slotted) and size stamp.

| | mm | mm | mm | mm | mm | mm | mm |
|---------------------------|-----|------|-----|-----|------|-------|-----|
| 05007610001 | 0,8 | 5,0 | 100 | 98 | 5,0 | 3/16" | 4" |
| 05007620001 | 1,0 | 6,0 | 125 | 105 | 6,0 | 1/4" | 5" |
| 05340330001 | 1,0 | 6,0 | 150 | 105 | 6,0 | 1/4" | 6" |
| 05110010001 | 1,2 | 6,5 | 150 | 105 | 6,0 | 1/4" | 6" |
| 05007635001 | 1,2 | 7,0 | 150 | 105 | 7,0 | 9/32" | 6" |
| 05007621001 | 1,2 | 6,5 | 200 | 105 | 7,0 | 9/32" | 8" |
| 05110011001 | 1,2 | 8,0 | 175 | 112 | 7,0 | 5/16" | 7" |
| 05007640001 | 1,6 | 8,0 | 175 | 112 | 7,0 | 5/16" | 7" |
| 05110104001 | 1,6 | 10,0 | 200 | 112 | 9,0 | 3/8" | 8" |
| 05110105001 ¹⁾ | 2,0 | 12,0 | 250 | 117 | 10,0 | 1/2" | 10" |

¹⁾ without Lasertip



334 SB Screwdriver for slotted screws

| | | | |
|--------------|--|-----------------|---------|
| | | | 4013288 |
| 051100030001 | | 1 x 1.2x6.5x150 | 181411 |
| 051100031001 | | 1 x 1.2x8.0x175 | 181220 |



378 B Screwdriver for slotted screws



Application: Slotted screws

Blade: Square as bolster

Design: Chrome-plated, Black Point

Handle: Kraftform with non-roll feature, multi-component, sizes 2.0 x 12.0 x 250, 2.5 x 14.0 x 225; Kraftform with non-roll feature, single-component. "Take it easy" tool finder: colour coding according to profile (yellow = slotted) and size stamp.

| | mm | mm | mm | mm | mm | mm | mm |
|-------------|-----|------|----|-----|-----|-------|--------|
| 05110050001 | 0,8 | 4,0 | 4 | 75 | 98 | 5/32" | 3" |
| 05110051001 | 1,0 | 5,5 | 5 | 100 | 98 | 7/32" | 4" |
| 05110052001 | 1,2 | 6,5 | 6 | 125 | 105 | 1/4" | 5" |
| 05110053001 | 1,6 | 8,0 | 8 | 150 | 112 | 5/16" | 6" |
| 05007355001 | 1,6 | 10,0 | 8 | 60 | 112 | 3/8" | 2 3/8" |
| 05110054001 | 1,6 | 10,0 | 8 | 175 | 112 | 3/8" | 7" |
| 05110150001 | 1,6 | 10,0 | 8 | 200 | 112 | 3/8" | 8" |
| 05110055001 | 2,0 | 12,0 | 10 | 200 | 112 | 1/2" | 8" |
| 05110151001 | 2,0 | 12,0 | 10 | 250 | 112 | 1/2" | 10" |

Tip



How to prevent the screwdriver from slipping out of the screw head?



It happens time and time again that the tip slips out of the screw head when screwdriving, sometimes damaging valuable surfaces or even causing injury. The tips of the Wera Lasertip screwdrivers are microscopically roughened by means of a laser. This rough surface literally "bites" itself firmly into the screw head. Slipping out becomes a thing of the past.



Why is the Kraftform Plus handle made out of several components?



Wera produces the Kraftform handle out of several materials with different properties. A resistant plastic is used for the core which ensures that the blade is held securely, even under high strain. A softer material is used for the coloured soft zones, which has a high frictional resistance and allows the transfer of high forces – thus requiring less screwdriving effort. The black sections with their hard surfaces prevent any "sticking" of the hand to the handle, making rapid repositioning of the hand possible.



Wera Black Point tip



The Wera Black Point tip and a refined hardening process ensure long service life of the tip, improved corrosion protection and an exact fit.

Kraftform Plus – Series 300

The answer to almost every screw.

350 SK PH Screwdriver for Phillips screws



Application: Phillips screws

Blade: Hexagonal, sizes 1 - 3 with bolster

Design: Chrome-plated, Lasertip

Handle: Kraftform with non-roll feature, multi-component. "Take it easy" tool finder: colour coding according to profile (red = Phillips) and size stamp.

| | + | mm | mm | mm | mm | mm |
|---------------------------|------|----|----|-----|-----|--------|
| 05008750001 ¹⁾ | PH 0 | 4 | | 60 | 81 | 2 3/8" |
| 05008751001 | PH 1 | 5 | 8 | 80 | 98 | 3 1/8" |
| 05008752001 | PH 2 | 6 | 10 | 100 | 105 | 4" |
| 05008753001 | PH 3 | 8 | 13 | 150 | 112 | 6" |

¹⁾ without Lasertip

350 PH Screwdriver for Phillips screws



Application: Phillips screws

Blade: Round

Design: Chrome-plated, Lasertip

Handle: Kraftform with non-roll feature, multi-component. "Take it easy" tool finder: colour coding according to profile (red = Phillips) and size stamp.

| | + | mm | mm | mm | mm |
|---------------------------|------|-----|-----|------|--------|
| 05008705001 ¹⁾ | PH 0 | 60 | 81 | 3,0 | 2 3/8" |
| 05008706001 ¹⁾ | PH 0 | 100 | 81 | 3,0 | 4" |
| 05008710001 | PH 1 | 80 | 98 | 4,5 | 3 1/8" |
| 05008712001 | PH 1 | 200 | 98 | 4,5 | 8" |
| 05008715001 ¹⁾ | PH 1 | 300 | 98 | 4,5 | 12" |
| 05008720001 | PH 2 | 100 | 105 | 6,0 | 4" |
| 05008723001 | PH 2 | 150 | 105 | 6,0 | 6" |
| 05008725001 | PH 2 | 200 | 105 | 6,0 | 8" |
| 05008730001 ¹⁾ | PH 2 | 300 | 105 | 6,0 | 12" |
| 05008735001 | PH 3 | 150 | 112 | 8,0 | 6" |
| 05008740001 ¹⁾ | PH 4 | 200 | 112 | 10,0 | 8" |

¹⁾ without Lasertip

350 PH SB Screwdriver for Phillips screws

| | | 4013288 |
|-------------|---------------------------|---------|
| 05100050001 | 1 x PH 0x60 ¹⁾ | 181329 |
| 05100051001 | 1 x PH 1x80 | 181336 |
| 05100052001 | 1 x PH 2x100 | 181343 |

¹⁾ without Lasertip





355 SK PZ Screwdriver for Pozidriv screws



Application: Suitable for Pozidriv screws

Blade: Hexagonal, sizes 1 - 3 with bolster

Design: Chrome-plated, Lasertip

Handle: Kraffform with non-roll feature, multi-component. "Take it easy" tool finder: colour coding according to profile (black = Pozidriv) and size stamp.

| | | mm | mm | mm | mm | mm |
|---------------------------|------|----|----|-----|-----|--------|
| 05009340001 ¹⁾ | PZ 0 | 4 | | 60 | 81 | 2 3/8" |
| 05009341001 | PZ 1 | 5 | 8 | 80 | 98 | 3 1/8" |
| 05009342001 | PZ 2 | 6 | 10 | 100 | 105 | 4" |
| 05009343001 | PZ 3 | 8 | 13 | 150 | 112 | 6" |

¹⁾ without Lasertip

355 PZ Screwdriver for Pozidriv screws



Application: Suitable for Pozidriv screws

Blade: Round

Design: Chrome-plated, Lasertip

Handle: Kraffform with non-roll feature, multi-component. "Take it easy" tool finder: colour coding according to profile (black = Pozidriv) and size stamp.

| | | mm | mm | mm | mm |
|---------------------------|------|-----|-----|------|--------|
| 05009305001 ¹⁾ | PZ 0 | 60 | 81 | 3,0 | 2 3/8" |
| 05009310001 | PZ 1 | 80 | 98 | 4,5 | 3 1/8" |
| 05009312001 | PZ 1 | 200 | 98 | 4,5 | 8" |
| 05009313001 ¹⁾ | PZ 1 | 300 | 98 | 4,5 | 12" |
| 05009315001 | PZ 2 | 100 | 105 | 6,0 | 4" |
| 05009317001 | PZ 2 | 200 | 105 | 6,0 | 8" |
| 05347743001 | PZ 2 | 250 | 105 | 6,0 | 10" |
| 05009319001 ¹⁾ | PZ 2 | 300 | 105 | 6,0 | 12" |
| 05009320001 | PZ 3 | 150 | 112 | 8,0 | 6" |
| 05009325001 ¹⁾ | PZ 4 | 200 | 112 | 10,0 | 8" |

¹⁾ without Lasertip

355 PZ SB Screwdriver for Pozidriv screws

| | | 4013288 |
|-------------|---------------------------|---------|
| 05100055001 | 1 x PZ 0x60 ¹⁾ | 181282 |
| 05100056001 | 1 x PZ 1x80 | 181299 |
| 05100057001 | 1 x PZ 2x100 | 181305 |



Kraftform Plus – Series 300

The answer to almost every screw.

354 Screwdriver for hexagon socket screws



Application: Hexagon socket screws
Blade: Round
Design: Hex-Plus, chrome-plated
Handle: Kraftform with non-roll feature, multi-component. "Take it easy" tool finder: colour coding according to profile (blue = hexagon) and size stamp.

| | mm | mm | mm | mm | " |
|-------------|-----|-----|-----|------|--------|
| 05023105001 | 2,0 | 75 | 70 | 3,0 | 3" |
| 05023107001 | 2,5 | 75 | 81 | 3,0 | 3" |
| 05023110001 | 3,0 | 75 | 81 | 4,0 | 3" |
| 05023115001 | 4,0 | 75 | 98 | 5,0 | 3" |
| 05023120001 | 5,0 | 80 | 105 | 6,0 | 3 1/8" |
| 05023125001 | 6,0 | 80 | 105 | 7,0 | 3 1/8" |
| 05023130001 | 8,0 | 100 | 112 | 10,0 | 4" |

352 Ball end screwdriver for hexagon socket screws

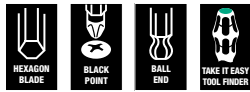

Application: Hexagon socket screws
Blade: Hexagonal
Design: Ball end hexagon, chrome-plated, Black Point
Handle: Kraftform with non-roll feature, multi-component, sizes W/F 12,0, W/F 1/2": Kraftform with non-roll feature, single-component. "Take it easy" tool finder: colour coding according to profile (blue = hexagon) and size stamp.

| | mm | mm | mm | mm | " |
|-------------|------|-------|-----|-----|--------|
| 05022795001 | 1,5 | | 60 | 70 | 2 3/8" |
| 05022800001 | 2,0 | | 100 | 70 | 4" |
| 05138070001 | 2,5 | | 100 | 81 | 4" |
| 05022805001 | 3,0 | | 100 | 81 | 4" |
| 05022810001 | 4,0 | | 100 | 98 | 4" |
| 05022815001 | 5,0 | | 100 | 105 | 4" |
| 05022820001 | 6,0 | | 125 | 105 | 5" |
| 05022825001 | 8,0 | | 150 | 112 | 6" |
| 05022830001 | 10,0 | | 150 | 112 | 6" |
| 05022835001 | 12,0 | | 150 | 117 | 6" |
| 05022905001 | | 5/32" | 100 | 98 | 4" |
| 05022910001 | | 3/16" | 100 | 105 | 4" |
| 05022915001 | | 7/32" | 100 | 105 | 4" |
| 05022920001 | | 1/4" | 125 | 105 | 5" |
| 05022925001 | | 5/16" | 150 | 112 | 6" |
| 05022930001 | | 3/8" | 150 | 112 | 6" |
| 05022935001 | | 1/2" | 150 | 117 | 6" |

367 TORX® HF Screwdriver with holding function for TORX® screws



Application: TORX® socket screws
Blade: Round
Design: Holding function for TORX® screws made according to Acument Intellectual Properties specifications, chrome-plated
Handle: Kraftform with non-roll feature, multi-component

| | | mm | mm | mm | " |
|-------------|-------|-----|-----|-----|---------|
| 05028048001 | TX 8 | 60 | 81 | 3,5 | 2 3/8" |
| 05028049001 | TX 9 | 60 | 81 | 4,0 | 2 3/8" |
| 05028050001 | TX 10 | 80 | 81 | 4,0 | 3 1/8" |
| 05028051001 | TX 15 | 80 | 98 | 4,0 | 3 1/8" |
| 05028052001 | TX 20 | 100 | 98 | 4,5 | 4" |
| 05028070001 | TX 20 | 300 | 98 | 4,5 | 12" |
| 05028053001 | TX 25 | 100 | 105 | 5,0 | 4" |
| 05028071001 | TX 25 | 300 | 105 | 6,0 | 12" |
| 05028054001 | TX 27 | 115 | 105 | 5,5 | 4 9/16" |
| 05028072001 | TX 27 | 300 | 105 | 6,0 | 12" |
| 05028055001 | TX 30 | 115 | 105 | 6,0 | 4 9/16" |
| 05028073001 | TX 30 | 300 | 105 | 6,0 | 12" |
| 05028056001 | TX 40 | 130 | 112 | 7,0 | 5 3/16" |



367 Screwdriver for TORX® screws



Application: TORX® socket screws

Blade: Round

Design: Chrome-plated, Black Point

Handle: Krafftform with non-roll feature, multi-component. "Take it easy" tool finder: colour coding according to profile (green = TORX®) and size stamp.

| | | mm | mm | mm | " |
|-------------|-------|-----|-----|-----|---------|
| 05028000001 | TX 5 | 60 | 70 | 3,5 | 2 3/8" |
| 05028001001 | TX 6 | 60 | 70 | 3,5 | 2 3/8" |
| 05028002001 | TX 7 | 60 | 70 | 3,5 | 2 3/8" |
| 05028003001 | TX 8 | 60 | 81 | 3,5 | 2 3/8" |
| 05028004001 | TX 9 | 60 | 81 | 4,0 | 2 3/8" |
| 05028005001 | TX 10 | 80 | 81 | 4,0 | 3 1/8" |
| 05028008001 | TX 15 | 80 | 98 | 4,0 | 3 1/8" |
| 05028010001 | TX 20 | 100 | 98 | 4,5 | 4" |
| 05028012001 | TX 25 | 100 | 105 | 5,0 | 4" |
| 05028013001 | TX 27 | 115 | 105 | 5,5 | 4 9/16" |
| 05028015001 | TX 30 | 115 | 105 | 6,0 | 4 9/16" |
| 05028020001 | TX 40 | 130 | 112 | 7,0 | 5 1/8" |
| 05028025001 | TX 45 | 130 | 112 | 8,0 | 5 1/8" |

367 SB Screwdriver for TORX® screws

| | | 4013288 |
|-------------|-----------------|---------|
| 05100060001 | ⊕ 1 x TX 10x80 | 181350 |
| 05100061001 | ⊕ 1 x TX 15x80 | 181367 |
| 05100062001 | ⊕ 1 x TX 20x100 | 181374 |
| 05100063001 | ⊕ 1 x TX 25x100 | 181381 |
| 05100064001 | ⊕ 1 x TX 30x115 | 181398 |



Tip



TORX® and hexagon ball tip



The spherical drive profile means that it is possible to swivel the axis of the tool to that of the screw, and therefore enable angled, "around-the-corner" screwdriving jobs. This ball tip geometry – often found on L-keys – is now available on a number of Wera bits.



What is the purpose of the HF profile?



In tight assembly or disassembly situations, for example in engine compartments, it is not possible to securely hold the screw with the hand on the screwdriver, and the screw subsequently often gets lost. Lengthy searches or the loss of the screw (with the associated danger that could bring about) are the consequence. The HF

tools developed by Wera are ideal because they feature an optimised geometry of the original TORX® profile. The wedging forces resulting from the surface pressure between the drive tip and the screw profile mean that the screw is securely held on the tool!



How to prevent rounded screw heads?



Hexagon socket screws are a problem, because the contact surfaces that transfer the force of the tool to the screw are very narrow. The consequence: the head of the screw can be damaged, usually rounding out the recess. Hex-Plus tools have larger contact surfaces to prevent this, driving from the flats of the recess, rather than the corners.

Good to know: Hex-Plus tools fit into every standard hexagon socket screw!

Kraftform Plus – Series 300

The answer to almost every screw.

367 K Ball end screwdriver for TORX® screws

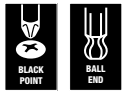

Application: TORX® socket screws

Blade: Round

Design: Ball end, chrome-plated, Black Point

Handle: Kraftform with non-roll feature, multi-component

| | | mm | mm | mm | " |
|-------------|-------|-----|-----|-----|---------|
| 05027950001 | TX 15 | 80 | 98 | 4,0 | 3 1/8" |
| 05027952001 | TX 20 | 100 | 98 | 4,5 | 4" |
| 05027954001 | TX 25 | 100 | 105 | 5,0 | 4" |
| 05027956001 | TX 27 | 115 | 105 | 5,5 | 4 9/16" |
| 05027958001 | TX 30 | 115 | 105 | 6,0 | 4 9/16" |

367 TORX® BO Screwdriver for tamper-proof TORX® screws



Application: TORX® screws with safety pin

(BO = with bore hole)

Blade: Round

Design: Bore hole in TORX® section, chrome-plated, Black Point

Handle: Kraftform with non-roll feature, multi-component

| | | mm | mm | mm | " |
|-------------|-------|-----|-----|-----|---------|
| 05138257001 | TX 7 | 60 | 70 | 3,5 | 2 3/8" |
| 05138258001 | TX 8 | 60 | 81 | 3,5 | 2 3/8" |
| 05138259001 | TX 9 | 60 | 81 | 4,0 | 2 3/8" |
| 05138260001 | TX 10 | 80 | 81 | 4,0 | 3 1/8" |
| 05138268001 | TX 10 | 300 | 81 | 4,0 | 12" |
| 05138261001 | TX 15 | 80 | 98 | 4,0 | 3 1/8" |
| 05138269001 | TX 15 | 300 | 98 | 4,0 | 12" |
| 05138262001 | TX 20 | 100 | 98 | 4,5 | 4" |
| 05138270001 | TX 20 | 300 | 98 | 4,5 | 12" |
| 05138263001 | TX 25 | 100 | 105 | 5,0 | 4" |
| 05138264001 | TX 27 | 115 | 105 | 5,5 | 4 9/16" |
| 05138265001 | TX 30 | 115 | 105 | 6,0 | 4 9/16" |
| 05138266001 | TX 40 | 130 | 112 | 7,0 | 5 3/16" |

367 TORX PLUS® Screwdriver for TORX PLUS® screws



Application: TORX PLUS® socket screws

Blade: Round

Design: Chrome-plated, Black Point

Handle: Kraftform with non-roll feature, multi-component

| | | mm | mm | mm | " |
|-------------|-------|-----|-----|-----|---------|
| 05028029001 | 5 IP | 60 | 70 | 3,5 | 2 3/8" |
| 05028030001 | 6 IP | 60 | 70 | 3,5 | 2 3/8" |
| 05028031001 | 7 IP | 60 | 70 | 3,5 | 2 3/8" |
| 05028032001 | 8 IP | 60 | 70 | 3,5 | 2 3/8" |
| 05028033001 | 9 IP | 60 | 81 | 4,0 | 2 3/8" |
| 05028034001 | 10 IP | 80 | 81 | 4,0 | 3 1/8" |
| 05028035001 | 15 IP | 80 | 98 | 4,0 | 3 1/8" |
| 05028036001 | 20 IP | 100 | 98 | 4,5 | 4" |
| 05028037001 | 25 IP | 100 | 105 | 5,0 | 4" |
| 05028038001 | 30 IP | 115 | 105 | 6,0 | 4 9/16" |

371 TORQ-SET® Mplus screwdriver for TORQ-SET® screws



Application: TORQ-SET® screws

Blade: Round

Design: Mplus for higher breaking torque and longer service life, chrome-plated

Handle: Kraftform with non-roll feature, multi-component

| | mm | mm | mm | mm | " |
|-------------|------|-----|-----|-----|--------|
| 05028130001 | 6 | 80 | 98 | 4,5 | 3 1/8" |
| 05028132001 | 8 | 100 | 105 | 6,0 | 4" |
| 05028134001 | 10 | 100 | 105 | 6,0 | 4" |
| 05028136001 | 1/4" | 125 | 112 | 8,0 | 5" |



Tip

How can I prevent frequent breakages of TORQ-SET® tools?

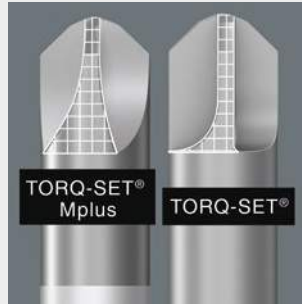

Wera developed the Mplus profile with stronger flanks compared with tools with a conventional TORQ-SET® profile. This results in approximately 70 % extra torsional strength and greatly extends the service life of Wera Mplus tools.

368 Screwdriver for square socket head screws



- Application:** Square socket screws
- Blade:** Round
- Design:** Chrome-plated, Black Point except for sizes 01+02
- Handle:** Kraffform with non-roll feature, multi-component, # 2/300, # 01/25, # 02/25: single-component

| | | | mm | mm | mm | |
|-------------|--|------|-----|-----|-----|--------|
| 05117680001 | | # 00 | 60 | 81 | 3,5 | 2 3/8" |
| 05117681001 | | # 0 | 60 | 81 | 4,0 | 2 3/8" |
| 05117682001 | | # 1 | 80 | 98 | 4,5 | 3 1/8" |
| 05117683001 | | # 1 | 200 | 98 | 4,5 | 8" |
| 05117684001 | | # 2 | 100 | 105 | 6,0 | 4" |
| 05117685001 | | # 2 | 200 | 105 | 6,0 | 8" |
| 05117691001 | | # 2 | 300 | 105 | 6,0 | 12" |
| 05117686001 | | # 3 | 150 | 112 | 8,0 | 6" |
| 05117687001 | | # 4 | 200 | 112 | 8,0 | 8" |
| 05117688001 | | # 01 | 25 | 54 | 4,5 | 1" |
| 05117689001 | | # 02 | 25 | 54 | 6,0 | 1" |

368 SB Screwdriver for square socket head screws

| | | | 4013288 |
|-------------|--|-------------|---------|
| 05100070001 | | 1 x # 1x80 | 181404 |
| 05100071001 | | 1 x # 2x100 | 181428 |
| 05100072001 | | 1 x # 3x150 | 181435 |



TORX PLUS®



Compared with the "normal" TORX® profile, the elliptical instead of circular profile enlarges the 6 flanks that transfer torque between the tool and the screw. This means that the force applied when screwdriving is spread across a larger surface area. Higher torque is transferred and, in addition, the service life of the screw and tool are lengthened. The so-called centre-lock screws on cutting tools represent a typical use of this type of screw profile. The thermal influences on such holders for carbide insert tips often "bake" the retaining screws so firmly that it is important to have

a profile that considerably enhances the loosening torque capability of the screws. For this reason a torque-stable screw profile is necessary to avoid any possible damage to the screw and to exclude the possibility of an otherwise costly machine downtime.

TORX® with borehole (BO)

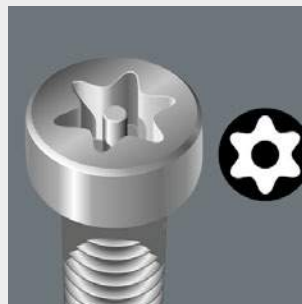

TORX® tools with a borehole prevent the unauthorised unfastening of safety screws. The screws contain a pin that protrudes into the drive profile so that "normal" TORX® tools cannot be used. This pin fits into the borehole of TORX® BO tools allowing safety screws to be unfastened.

Kraftform Plus – Series 300

The answer to almost every screw.

375 TRI-WING® screwdriver for TRI-WING® screws



Application: TRI-WING® screws

Blade: Round

Design: Chrome-plated, Black Point

Handle: Kraftform with non-roll feature, multi-component

| | | mm | mm | mm | |
|-------------|---|-----|----|-----|--------|
| 05028116001 | 0 | 80 | 81 | 3,5 | 3 1/8" |
| 05028118001 | 1 | 80 | 81 | 3,5 | 3 1/8" |
| 05028120001 | 2 | 80 | 98 | 4,5 | 3 1/8" |
| 05028122001 | 3 | 80 | 98 | 4,5 | 3 1/8" |
| 05028124001 | 4 | 100 | 98 | 6,0 | 4" |
| 05028126001 | 5 | 100 | 98 | 6,0 | 4" |

395 Nutdriver



Application: Hexagon headed bolts, screws and nuts

Blade: Round

Design: Chrome-plated, nutdriver for hexagon head bolts

Handle: Kraftform with non-roll feature, multi-component

| | mm | mm | mm | mm | |
|-------------|------|-----|-----|------|----|
| 05028205001 | 3,0 | 125 | 98 | 5,0 | 5" |
| 05028210001 | 3,5 | 125 | 98 | 6,1 | 5" |
| 05028215001 | 4,0 | 125 | 98 | 6,9 | 5" |
| 05028220001 | 4,5 | 125 | 98 | 7,1 | 5" |
| 05028225001 | 5,0 | 125 | 98 | 8,1 | 5" |
| 05028230001 | 5,5 | 125 | 98 | 8,1 | 5" |
| 05029405001 | 6,0 | 125 | 98 | 9,1 | 5" |
| 05029410001 | 7,0 | 125 | 105 | 11,0 | 5" |
| 05029415001 | 8,0 | 125 | 105 | 12,1 | 5" |
| 05029420001 | 9,0 | 125 | 105 | 13,1 | 5" |
| 05029425001 | 10,0 | 125 | 112 | 14,1 | 5" |
| 05029430001 | 11,0 | 125 | 112 | 16,0 | 5" |
| 05029435001 | 12,0 | 125 | 112 | 17,1 | 5" |
| 05029440001 | 13,0 | 125 | 112 | 18,1 | 5" |
| 05029445001 | 14,0 | 125 | 112 | 19,1 | 5" |
| 05029450001 | 15,0 | 125 | 112 | 21,0 | 5" |

391 Hose clamp screwdriver



Application: Hexagon headed bolts, screws and nuts

Blade: Round, flexible

Design: Nutdriver for hexagon head bolts

Handle: Kraftform with non-roll feature, multi-component

| | mm | mm | mm | |
|-------------|----|-----|----|---------|
| 05028148001 | 6 | 167 | 98 | 6 9/16" |
| 05028150001 | 7 | 167 | 98 | 6 9/16" |
| 05028152001 | 8 | 167 | 98 | 6 9/16" |

395 HO Nutdriver









Application: Hexagon headed bolts, screws and nuts

Blade: Round

Design: Chrome-plated, hollow shaft for protruding threaded rods

Handle: Kraftform with non-roll feature, multi-component

TIP: The hollow shaft enables seized screws or those on long threads to be tightened and loosened

| |  |  |  |  |  |  |
|-------------|---|---|---|---|---|---|
| | mm | mm | mm | mm | mm | mm |
| 05029460001 | 5,0 | 90 | 98 | 7,2 | 3 35/64" | 3 35/64" |
| 05029461001 | 5,5 | 90 | 98 | 7,2 | 3 35/64" | 3 35/64" |
| 05029462001 | 6,0 | 90 | 98 | 7,2 | 3 35/64" | 3 35/64" |
| 05029463001 | 7,0 | 90 | 105 | 7,2 | 3 35/64" | 3 35/64" |
| 05029464001 | 8,0 | 90 | 105 | 9,3 | 3 35/64" | 3 35/64" |
| 05029465001 | 10,0 | 90 | 112 | 9,3 | 3 35/64" | 3 35/64" |
| 05029466001 | 13,0 | 90 | 112 | 11,0 | 3 35/64" | 3 35/64" |
| 05029501001 | | 3/16" | 90 | 98 | 7,2 | 3 35/64" |
| 05029502001 | | 1/4" | 90 | 98 | 7,2 | 3 35/64" |
| 05029503001 | | 5/16" | 90 | 105 | 9,3 | 3 35/64" |
| 05029504001 | | 11/32" | 90 | 105 | 9,3 | 3 35/64" |
| 05029505001 | | 3/8" | 90 | 112 | 9,3 | 3 35/64" |
| 05029506001 | | 7/16" | 90 | 112 | 11,0 | 3 35/64" |
| 05029507001 | | 1/2" | 90 | 112 | 11,0 | 3 35/64" |

Tip



What is the purpose of a screwdriver with hollow shaft?

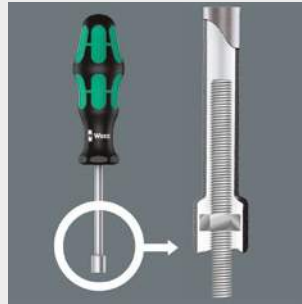

A screwdriver with a hollow shaft is needed whenever there are screwdriving jobs involving threaded rods i.e. the threaded rod through the nut can slip into the hollow shaft of the screwdriver.



Flexible shaft



Screwdriving can also be achieved "around the corner" with the screwdriver 391. The flexible shaft allows unfavourably-positioned screw fastenings to be reached. The ideal tool for difficult-to-access screwdriving applications e.g. in the engine compartment of a car.

The TRI-WING® screwdriving system



The TRI-WING® screwdriving system is mainly found in aviation and household technology (here e.g. on live components). The asymmetric arrangement of the three profile flanks prevents the use of anything other than the original tools. The high-precision Wera profile design ensures a secure fit of the tool in the head of the screw. The blades are manufactured out of bit material. The Wera know-how with regard to the hardening technology ensures a long service life of the tool.

Kraftform Plus – Series 300

The answer to almost every screw.

336 Stubby/Carburettor screwdriver









Application: Slotted screws

Blade: Round

Design: Chrome-plated, Black Point

Handle: Kraftform with non-roll feature, single-component

| |  mm |  mm |  mm |  mm |  mm |  mm |  mm |
|-------------|--|--|--|--|--|--|--|
| 05110068001 | 0,6 | 3,5 | 25 | 54 | 3,5 | $\frac{9}{64}$ " | 1" |
| 05110069001 | 0,8 | 4,0 | 25 | 54 | 4,0 | $\frac{5}{32}$ " | 1" |
| 05110070001 | 1,0 | 5,5 | 25 | 54 | 5,5 | $\frac{7}{32}$ " | 1" |
| 05110075001 | 1,2 | 6,5 | 25 | 54 | 6,5 | $\frac{1}{4}$ " | 1" |
| 05110078001 | 1,2 | 8,0 | 25 | 54 | 8,0 | $\frac{5}{16}$ " | 1" |

Stubby/Carburettor screwdriver







Application: Phillips screws

Blade: Round

Design: Chrome-plated, Black Point

Handle: Kraftform, with non-roll feature, single-component

| |  |  mm |  mm |  mm |  mm |
|-------------|---|--|--|--|--|
| 05008775001 | PH 01 | 25 | 54 | 4,5 | 1" |
| 05008780001 | PH 02 | 25 | 54 | 6,0 | 1" |
| 05008782001 | PH 03 | 25 | 54 | 8,0 | 1" |

Stubby/Carburettor screwdriver







Application: Suitable for Pozidriv screws

Blade: Round

Design: Chrome-plated, Black Point

Handle: Kraftform with non-roll feature, single-component

| |  |  mm |  mm |  mm |  mm |
|-------------|---|--|--|--|--|
| 05009330001 | PZ 01 | 25 | 54 | 4,5 | 1" |
| 05009335001 | PZ 02 | 25 | 54 | 6,0 | 1" |
| 05009337001 | PZ 03 | 25 | 54 | 8,0 | 1" |



Kraftform Big Pack 300

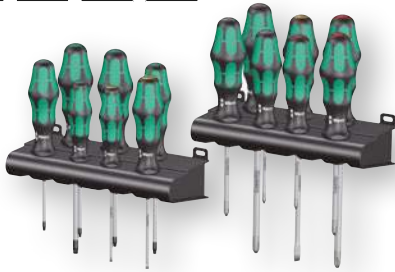

Kraftform Plus – Series 300. With Lasertip blade, voltage tester and rack. “Take it easy” tool finder: colour coding according to profile and size stamp.

Application: Slotted, cross, Phillips-Recess, Pozidriv and TORX® screws

Content: 14-piece set in display carton

| | | |
|-------------|-----------|---|
| 05105630001 | | |
| + | 350 PH | 1 x PH 1x80; 1 x PH 2x100; 1 x PH 3x150 |
| + | 355 PZ | 1 x PZ 1x80; 1 x PZ 2x100; 1 x PZ 3x150 |
| + | 367 TORX® | 1 x TX 10x80; 1 x TX 15x80; 1 x TX 20x100; 1 x TX 25x100; 1 x TX 30x115 |
| + | 334 | 1 x 1,2x6,5x150 |
| + | 335 | 1 x 0,6x3,5x100; 1 x 0,8x4,0x100 |
| | Rack | 2 x 190,0x50,0 |

Kraftform XXL



12-piece screwdriver set for all-round applications. “Take it easy” tool finder: colour coding according to profile and size stamp.

| | | |
|-------------|-----------|--|
| 05051010001 | | |
| + | 350 PH | 1 x PH 1x80; 1 x PH 2x100 |
| + | 355 PZ | 1 x PZ 1x80; 1 x PZ 2x100 |
| + | 932 A | 1 x 1,0x5,5x100; 1 x 1,2x7,0x125 |
| + | 334 | 1 x 1,2x6,5x150 |
| + | 335 | 1 x 0,8x4,0x100; 1 x 1,0x5,5x125 |
| + | 160 i VDE | 1 x 0,4x2,5x80 ¹⁾ ; 1 x 0,6x3,5x100 |
| + | 247 | 1 x 0,5x3,0x70 |
| | Rack | 2 x 190,0x50,0 |

¹⁾ without Lasertip

²⁾ Product not available in the USA and Canada.

Tip



Screwdrivers “Take it easy”



“Take it easy” tool finder: colour coding according to profile and size stamp. This enables faster and more reliable selection of the correct tool from the tool case.



The Chiseldriver



An integrated impact cap lengthens the service life and reduces the danger of splintering. Nevertheless, always wear protective goggles.

Kraftform Plus – Series 300

The answer to almost every screw.

Kraftform XXL 2



12-piece screwdriver set for all-round applications. "Take it easy" tool finder: colour coding according to profile and size stamp.

| | | |
|-------------|-----------|--|
| 05051011001 | | |
| + | 350 PH | 1 x PH 2x100 |
| + | 355 PZ | 1 x PZ 1x80; 1 x PZ 2x100 |
| ⊖ | 932 A | 1 x 1,0x5,5x100; 1 x 1,2x7,0x125 |
| ⊖ | 335 | 1 x 0,8x4,0x100 |
| ⊕ | 367 TORX® | 1 x TX 15x80; 1 x TX 20x100; 1 x TX 25x100 |
| ⊖ | 160 i VDE | 1 x 0,4x2,5x80 ¹⁾ ; 1 x 0,6x3,5x100 |
| ⊖ | 247 | 1 x 0,5x3,0x70 |
| | Rack | 2 x 190,0x50,0 |

¹⁾ without Lasertip

²⁾ Product not available in the USA and Canada.

Kraftform XXL 3



11-piece screwdriver set for all-round applications. "Take it easy" tool finder: colour coding according to profile and size stamp.

| | | |
|-------------|-----------|--|
| 05347106001 | | |
| ⊖ | 160 i VDE | 1 x 0,4x2,5x80 ¹⁾ ; 1 x 0,6x3,5x100 |
| + | 350 PH | 1 x PH 1x80; 1 x PH 2x100 |
| ⊖ | 932 A | 1 x 1,0x5,5x100; 1 x 1,2x7,0x125 |
| ⊖ | 335 | 1 x 0,8x4,0x100; 1 x 1,0x5,5x125 |
| ⊖ | 334 | 1 x 1,2x6,5x150 |
| ⊖ | 368 | 1 x # 1x80; 1 x # 2x100 |
| | Rack | 2 x 190,0x50,0 |

¹⁾ without Lasertip

Kraftform 2go 300



11 Kraftform screwdrivers, Series 300 for cross recess screws Phillips and Pozidriv, TORX® and slotted screws. "Take it easy" tool finder: colour coding according to profile and size stamp.

1 dimensionally stable and robust Tool Quiver, equipped with handle for the storage and transport of tools; high resistance against cuts and stabs; comes with hook and loop fastener zone for docking with the Wera 2go system and includes 1 variably adjustable hook and loop fastener partition for a division into as many as 5 sections.

| | | |
|-------------|------------------------------|---|
| 05004313001 | | |
| | Wera 2go 4 | 1 x 165,0x165,0x105 |
| + | 350 PH | 1 x PH 1x80; 1 x PH 2x100 |
| + | 355 PZ | 1 x PZ 1x80; 1 x PZ 2x100 |
| ⊕ | 367 TORX® | 1 x TX 10x80; 1 x TX 15x80; 1 x TX 20x100; 1 x TX 25x100; 1 x TX 30x115 |
| ⊖ | 334 SK | 1 x 0,8x4,5x90; 1 x 1,2x7,0x125 |
| | Hook and Loop Fastener Strip | 1 x 50,0x120,0 |



Kraftform Plus – Series 300

The answer to almost every screw.

334 SK/6 Rack screwdriver set Kraftform Plus Lasertip and rack



Lasertip hexagon blades and rack. "Take it easy" tool finder: colour coding according to profile and size stamp.

Application: Slotted and Phillips screws

Content: 6-piece set and rack in display carton

| | |
|-------------|--|
| 05007680001 | |
| + | 350 SK PH 1 x PH 1x80; 1 x PH 2x100 |
| - | 334 SK 1 x 0,6x3,5x75; 1 x 0,8x4,0x90; 1 x 1,0x5,5x100; 1 x 1,2x6,5x125 |

334/355 SK/6 Screwdriver set Kraftform Plus Lasertip and rack



Lasertip hexagonal blades and rack. "Take it easy" tool finder: colour coding according to profile and size stamp.

Application: Slotted and Pozidriv screws

Content: 6-piece set and rack in display carton

| | |
|-------------|--|
| 05007681001 | |
| + | 355 SK PZ 1 x PZ 1x80; 1 x PZ 2x100 |
| - | 334 SK 1 x 0,6x3,5x75; 1 x 0,8x4,0x90; 1 x 1,0x5,5x100; 1 x 1,2x6,5x125 |

334/6 Rack screwdriver set Kraftform Plus Lasertip and rack



Lasertip round blades and rack. "Take it easy" tool finder: colour coding according to profile and size stamp.

Application: Slotted and Phillips screws

Content: 6-piece set and rack in display carton

| | |
|-------------|--|
| 05105650001 | |
| + | 350 PH 1 x PH 1x80; 1 x PH 2x100 |
| - | 334 1 x 1,2x6,5x150 |
| - | 335 1 x 0,5x3,0x80 ¹⁾ ; 1 x 0,8x4,0x100; 1 x 1,0x5,5x125 |

¹⁾ without Lasertip

334/355/6 Rack screwdriver set Kraftform Plus Lasertip and rack



Lasertip round blades and rack. "Take it easy" tool finder: colour coding according to profile and size stamp.

Application: Slotted and Pozidriv screws

Content: 6-piece set and rack in display carton

| | |
|-------------|--|
| 05105656001 | |
| + | 355 PZ 1 x PZ 1x80; 1 x PZ 2x100 |
| - | 334 1 x 1,2x6,5x150 |
| - | 335 1 x 0,5x3,0x80 ¹⁾ ; 1 x 0,8x4,0x100; 1 x 1,0x5,5x125 |

¹⁾ without Lasertip



335/350/355/6 Screwdriver set Kraftform Plus Lasertip and rack



Lasertip blades and rack. "Take it easy" tool finder: colour coding according to profile and size stamp.

Application: Slotted, Phillips and Pozidriv screws

Content: 6-piece set and rack in display carton

| | | |
|-------------|--------|----------------------------------|
| 05105622001 | | |
| + | 350 PH | 1 x PH 1x80; 1 x PH 2x100 |
| + | 355 PZ | 1 x PZ 1x80; 1 x PZ 2x100 |
| - | 335 | 1 x 0,8x4,0x100; 1 x 1,0x5,5x125 |

335/350/355/3 Screwdriver set Kraftform Plus with holding function and 300 mm-long blades



"Take it easy" tool finder: colour coding according to profile and size stamp.

Application: Slotted, Phillips and Pozidriv screws

Content: 3-piece set

| | | |
|-------------|--------|-------------------------------|
| 05347735002 | | |
| + | 350 PH | 1 x PH 2x300 ¹⁾ |
| + | 355 PZ | 1 x PZ 2x300 ¹⁾ |
| - | 335 | 1 x 1,0x5,5x300 ¹⁾ |

¹⁾ without Lasertip

Tip



Screwdrivers "Take it easy"



"Take it easy" tool finder: colour coding according to profile and size stamp. This enables faster and more reliable selection of the correct tool from the tool case.



How to prevent the screwdriver from slipping out of the screw head?



It happens time and time again that the tip slips out of the screw head when screwdriving, sometimes damaging valuable surfaces or even causing injury. The tips of the Wera Lasertip screwdrivers are microscopically roughened by means of a laser. This rough surface literally "bites" itself firmly into the screw head. Slipping out becomes a thing of the past.



Why is the Kraftform Plus handle made out of several components?



Wera produces the Kraftform handle out of several materials with different properties. A resistant plastic is used for the core which ensures that the blade is held securely, even under high strain. A softer material is used for the coloured soft zones, which has a high frictional resistance and allows the transfer of high forces – thus requiring less screwdriving effort. The black sections with their hard surfaces prevent any "sticking" of the hand to the handle, making rapid repositioning of the hand possible.

Kraftform Plus – Series 300

The answer to almost every screw.

335/350/355/4 Screwdriver set Kraftform Plus Lasertip with holding function and 200 mm-long blades



Lasertip blades. "Take it easy" tool finder: colour coding according to profile and size stamp.

Application: Slotted, Phillips and Pozidriv screws

Content: 4-piece set

| | | |
|-------------|--------|----------------------------|
| 05347736002 | | |
| + | 350 PH | 1 x PH 2x200 |
| + | 355 PZ | 1 x PZ 1x200; 1 x PZ 2x200 |
| - | 335 | 1 x 1,0x5,5x200 |

335/350/367/7 Rack screwdriver set Kraftform Plus Lasertip and rack

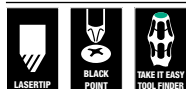

Lasertip round blades and rack. "Take it easy" tool finder: colour coding according to profile and size stamp.

Application: Slotted, cross, Phillips-Recess, Pozidriv and TORX® screws

Content: 7-piece set and rack in display carton

| | | |
|-------------|-----------|--|
| 05320540001 | | |
| + | 350 PH | 1 x PH 2x100 |
| + | 355 PZ | 1 x PZ 1x80; 1 x PZ 2x100 |
| - | 335 | 1 x 0,8x4,0x100 |
| ⊕ | 367 TORX® | 1 x TX 15x80; 1 x TX 20x100; 1 x TX 25x100 |

367/7 TORX® HF Kraftform Plus screwdriver set with holding function and rack



Application: TORX®

Content: 7-piece set and rack in display carton

| | |
|-------------|--|
| 05223161001 | |
| ⊕ | 367 TORX® HF 1 x TX 8x60; 1 x TX 10x80; 1 x TX 15x80; 1 x TX 20x100; 1 x TX 25x100; 1 x TX 27x115; 1 x TX 30x115 |

367/6 TORX® HF Kraftform Plus screwdriver set with holding function and rack



Application: TORX®

Content: 6-piece set and rack in display carton

| | |
|-------------|---|
| 05028059001 | |
| ⊕ | 367 TORX® HF 1 x TX 10x80; 1 x TX 15x80; 1 x TX 20x100; 1 x TX 25x100; 1 x TX 30x115; 1 x TX 40x130 |

367/4 TORX® HF Kraftform Plus screwdriver set with holding function and 300 mm-long blades

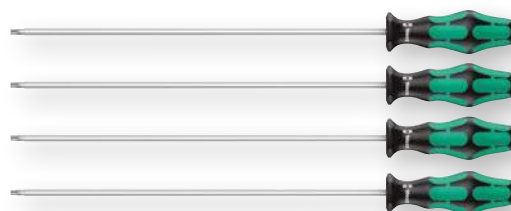

Application: TORX® with holding function, extra long (300 mm) blade

Content: 4-piece set

| | |
|-------------|---|
| 05028074001 | |
| ⊕ | 367 TORX® HF 1 x TX 20x300; 1 x TX 25x300; 1 x TX 27x300; 1 x TX 30x300 |



367/6 Screwdriver set Krafftform Plus TORX® and rack



Application: TORX®

Content: 6-piece set with "Take it easy" tool finder: colour coding according to profile and size stamp and rack in display carton.

| | |
|-------------|--|
| 05028062001 | |
| ⊕ | 367 TORX® 1 x TX 10x80; 1 x TX 15x80; 1 x TX 20x100; 1 x TX 25x100; 1 x TX 30x115; 1 x TX 40x130 |

334/368/6 Screwdriver set and rack



Application: Slotted, Phillips and square-head screws

Content: 6-piece set with "Take it easy" tool finder: colour coding according to profile and size stamp and rack in display carton

| | |
|-------------|----------------------------------|
| 05347778001 | |
| ⊕ | 350 PH 1 x PH 1x80; 1 x PH 2x100 |
| ⊖ | 334 1 x 1,2x6,5x150 |
| ⊖ | 335 1 x 0,8x4,0x100 |
| ⊖ | 368 1 x # 1x80; 1 x # 2x100 |

367/6 TORX® B0 Krafftform Plus screwdriver set and rack



Application: TORX® screws with safety pin (B0 = with bore hole)

Content: 6-piece set and rack in display carton

| | |
|-------------|---|
| 05138250001 | |
| ⊕ | 367 TORX® B0 1 x TX 10x80; 1 x TX 15x80; 1 x TX 20x100; 1 x TX 25x100; 1 x TX 30x115; 1 x TX 40x130 |

395 H0/7 SM Nutdriver set



Application: Hexagon headed bolts, screws and nuts

Content: 7-piece set in display carton

TIP: The hollow shaft enables seized screws or those on long threads to be tightened and loosened

| | |
|-------------|---|
| 05029510001 | |
| ⊕ | 395 H0 1 x 5,0x90; 1 x 5,5x90; 1 x 6,0x90; 1 x 7,0x90; 1 x 8,0x90; 1 x 10,0x90; 1 x 13,0x90 |

Kraftform Comfort Screwdrivers

The ergonomic introduction to convenient screwdriving.

Handle with Kraftform geometry and blade made from power bit material with Black Point tip for precise fit.

For all kinds of application.



The multi-component Kraftform handle for quick and low-exertion working.



The screw symbol and tip size identification markings on the handle make it easier to find the right screwdriver in the tool case, or at the workplace.



The hexagonal non-roll feature prevents any annoying rolling away.



The Wera Black Point tip and a refined hardening process ensure long service life of the tip, improved corrosion protection and an exact fit.

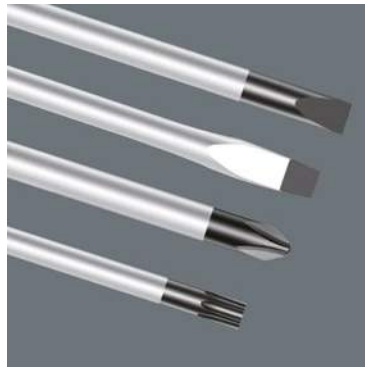

The bit material used for manufacturing is subjected to a specific Wera hardening process, and this ensures longer product service life.







Kraftform Comfort

Convenient, safe, good!

1335 Screwdriver for slotted screws









Application: Slotted screws
Blade: Round
Design: Chrome-plated, Black Point
Handle: Kraftform Comfort with non-roll feature, multi-component

| |  mm |  mm |  mm |  mm |  mm |  mm |  mm |
|-------------|--|--|--|--|--|--|--|
| 05031400001 | 0,4 | 2,0 | 60 | 81 | 2,5 | $\frac{5}{64}$ " | $2\frac{3}{8}$ " |
| 05031401001 | 0,4 | 2,5 | 75 | 81 | 2,5 | $\frac{3}{32}$ " | 3" |
| 05031402001 | 0,5 | 3,0 | 80 | 81 | 3,0 | $\frac{1}{8}$ " | $3\frac{1}{8}$ " |
| 05031403001 | 0,5 | 3,0 | 150 | 81 | 3,0 | $\frac{1}{8}$ " | 6" |
| 05031405001 | 0,6 | 3,5 | 100 | 81 | 3,5 | $\frac{9}{64}$ " | 4" |
| 05031406001 | 0,6 | 3,5 | 125 | 81 | 3,5 | $\frac{9}{64}$ " | 5" |
| 05031408001 | 0,8 | 4,0 | 100 | 98 | 4,0 | $\frac{5}{32}$ " | 4" |
| 05031409001 | 0,8 | 4,0 | 150 | 98 | 4,0 | $\frac{5}{32}$ " | 6" |
| 05031411001 | 0,8 | 4,0 | 300 | 98 | 4,0 | $\frac{5}{32}$ " | 12" |
| 05031412001 | 1,0 | 5,5 | 125 | 98 | 5,5 | $\frac{7}{32}$ " | 5" |
| 05031413001 | 1,0 | 5,5 | 150 | 98 | 5,5 | $\frac{7}{32}$ " | 6" |
| 05031416001 | 1,2 | 6,0 | 100 | 105 | 6,0 | $\frac{15}{64}$ " | 4" |

1334 Screwdriver for slotted screws







Application: Slotted screws
Blade: Round
Design: Chrome-plated, Black Point
Handle: Kraftform Comfort with non-roll feature, multi-component

| |  mm |  mm |  mm |  mm |  mm |  mm |  mm |
|-------------|--|--|--|--|--|--|--|
| 05031420001 | 0,8 | 5,0 | 100 | 98 | $\frac{3}{16}$ " | 4" | |
| 05031421001 | 1,0 | 6,0 | 125 | 105 | $\frac{15}{64}$ " | 5" | |
| 05031422001 | 1,2 | 6,5 | 150 | 105 | $\frac{1}{4}$ " | 6" | |
| 05031424001 | 1,2 | 7,0 | 150 | 105 | $\frac{9}{32}$ " | 6" | |
| 05031425001 | 1,2 | 8,0 | 175 | 112 | $\frac{5}{16}$ " | 7" | |
| 05031426001 | 1,6 | 8,0 | 175 | 112 | $\frac{5}{16}$ " | 7" | |
| 05031427001 | 1,6 | 10,0 | 200 | 112 | $\frac{3}{8}$ " | 8" | |

1350 PH Screwdriver for Phillips screws







Application: Phillips screws
Blade: Round
Design: Chrome-plated, Black Point
Handle: Kraftform Comfort with non-roll feature, multi-component

| |  |  mm |  mm |  mm |  mm |
|-------------|---|--|--|--|--|
| 05031440001 | PH 0 | 60 | 81 | 3,0 | $2\frac{3}{8}$ " |
| 05031441001 | PH 1 | 80 | 98 | 4,5 | $3\frac{1}{8}$ " |
| 05031442001 | PH 1 | 200 | 98 | 4,5 | 8" |
| 05031444001 | PH 2 | 100 | 105 | 6,0 | 4" |
| 05031445001 | PH 2 | 200 | 105 | 6,0 | 8" |
| 05031447001 | PH 3 | 150 | 112 | 8,0 | 6" |

1355 PZ Screwdriver for Pozidriv screws



Application: Suitable for Pozidriv screws
Blade: Round
Design: Chrome-plated, Black Point
Handle: Kraftform Comfort with non-roll feature, multi-component

| |  |  mm |  mm |  mm |  mm |
|-------------|---|--|--|--|--|
| 05031460001 | PZ 0 | 60 | 81 | 3,0 | $2\frac{3}{8}$ " |
| 05031461001 | PZ 1 | 80 | 98 | 4,5 | $3\frac{1}{8}$ " |
| 05031463001 | PZ 2 | 100 | 105 | 6,0 | 4" |
| 05031466001 | PZ 3 | 150 | 112 | 8,0 | 6" |



Tip

1367 TORX® screwdriver for TORX® screws



- Application:** TORX® socket screws
- Blade:** Round
- Design:** Chrome-plated, Black Point
- Handle:** Kraffform Comfort with non-roll feature, multi-component

| | | mm | mm | mm | " |
|-------------|-------|--------|--------|--------|---------|
| 05031500001 | TX 5 | 60 | 81 | 3,5 | 2 3/8" |
| 05031501001 | TX 6 | 60 | 81 | 3,5 | 2 3/8" |
| 05031502001 | TX 7 | 60 | 81 | 3,5 | 2 3/8" |
| 05031503001 | TX 8 | 60 | 81 | 3,5 | 2 3/8" |
| 05031504001 | TX 9 | 60 | 81 | 4,0 | 2 3/8" |
| 05031505001 | TX 10 | 80 | 81 | 4,0 | 3 1/8" |
| 05031506001 | TX 15 | 80 | 98 | 4,0 | 3 1/8" |
| 05031507001 | TX 20 | 100 | 98 | 4,5 | 4" |
| 05031508001 | TX 25 | 100 | 105 | 5,0 | 4" |
| 05031509001 | TX 27 | 115 | 105 | 5,5 | 4 9/16" |
| 05031510001 | TX 30 | 115 | 105 | 6,0 | 4 9/16" |
| 05031511001 | TX 40 | 130 | 112 | 7,0 | 5 3/16" |
| 05031512001 | TX 45 | 130 | 112 | 8,0 | 5 1/8" |



The Wera Black Point tip

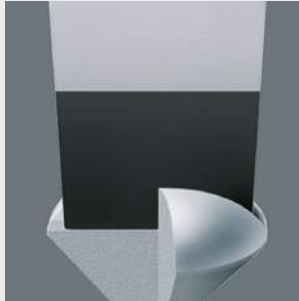

The Wera Black Point tip and a refined hardening process ensure long service life of the tip, improved corrosion protection and an exact fit.

The screw symbol



The screw symbol and tip size identification markings on the handle make it easier to find the right screwdriver in the tool case, or at the workplace.

Kraftform Comfort

Convenient, safe, good!

1334/6 Screwdriver set Kraftform Comfort



Application: Slotted and Phillips screws

Content: 6-piece set in display carton

| | |
|-------------|--|
| 05031551001 | |
| + | 1350 PH 1 x PH 1x80; 1 x PH 2x100 |
| + | 1335 1 x 0,5x3,0x80; 1 x 0,8x4,0x100; 1 x 1,0x5,5x125 |
| + | 1334 1 x 1,2x6,5x150 |

1335/1350/1355/6 Screwdriver set Kraftform Comfort



Application: Slotted, Phillips and Pozidriv screws

Content: 6-piece set in display carton

| | |
|-------------|---------------------------------------|
| 05031553001 | |
| + | 1350 PH 1 x PH 1x80; 1 x PH 2x100 |
| + | 1355 PZ 1 x PZ 1x80; 1 x PZ 2x100 |
| + | 1335 1 x 0,8x4,0x100; 1 x 1,0x5,5x125 |

1334/1355/6 Screwdriver set Kraftform Comfort



Application: Slotted and Pozidriv screws

Content: 6-piece set in display carton

| | |
|-------------|--|
| 05031552001 | |
| + | 1355 PZ 1 x PZ 1x80; 1 x PZ 2x100 |
| + | 1335 1 x 0,5x3,0x80; 1 x 0,8x4,0x100; 1 x 1,0x5,5x125 |
| + | 1334 1 x 1,2x6,5x150 |

1367/6 TORX® Screwdriver set Kraftform Comfort



Application: TORX® screws

Content: 6-piece set in display carton

| | |
|-------------|--|
| 05031554001 | |
| + | 1367 TORX® 1 x TX 10x80; 1 x TX 15x80; 1 x TX 20x100; 1 x TX 25x100; 1 x TX 30x115; 1 x TX 40x130 |



Screwdrivers with wooden handles

The traditional screwdriver with very specific product benefits.



Higher torque can be transferred by fitting an open-jaw or ring spanner over the hex bolster that is welded to the blade.

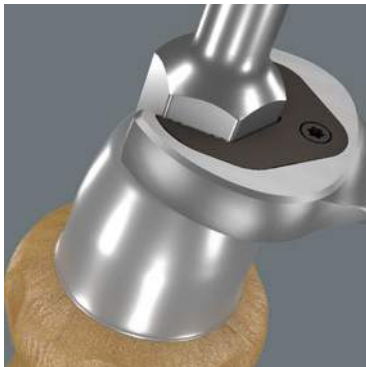

A double leather cap combined with the blade that extends right through the handle provide additional safety and reduce the danger of a splintering of the handle when struck with a hammer.



With pound-thru blade out of high quality bit material. As a result, loss-free transfer of power, even in the case of hammer blows. The material prevents any splintering or breakage of the blade.



The Wera Black Point tip and a refined hardening process ensure long service life of the tip, improved corrosion protection and an exact fit.









Wooden Handle Series

Traditionally good quality!

930 A Screwdriver for slotted screws







Application: Slotted screws
Blade: Round, hexagon bolster
Design: Chrome-plated, Black Point
Handle: Beech wood with leather cap

| |  mm |  mm |  mm |  mm |  mm |  mm |  mm |
|-------------|--|--|--|--|--|--|--|
| 05018005001 | 0,6 | 3,5 | 8 | 90 | 102 | $\frac{9}{64}$ " | $3\frac{1}{2}$ " |
| 05018010001 | 0,8 | 4,5 | 8 | 90 | 102 | 0,178" | $3\frac{1}{2}$ " |
| 05018015001 | 1,0 | 5,5 | 8 | 100 | 102 | $\frac{7}{32}$ " | 4" |
| 05018020001 | 1,2 | 7,0 | 10 | 125 | 111 | $\frac{9}{32}$ " | 5" |
| 05018025001 | 1,6 | 9,0 | 13 | 175 | 126 | $\frac{11}{32}$ " | 7" |
| 05018030001 | 1,6 | 10,0 | 13 | 175 | 126 | $\frac{3}{8}$ " | 7" |
| 05018035001 | 2,0 | 12,0 | 13 | 200 | 126 | $\frac{1}{2}$ " | 8" |
| 05018040001 | 2,5 | 14,0 | 16 | 250 | 140 | $\frac{9}{16}$ " | 10" |

935 SPH Screwdriver for Phillips screws







Application: Phillips screws
Blade: Round, hexagon bolster
Design: Chrome-plated, Black Point
Handle: Beech wood with leather cap

| |  mm |  mm |  mm |  mm |  mm |
|-------------|--|--|--|--|--|
| 05018350001 | PH 1 | 8 | 90 | 102 | $3\frac{1}{2}$ " |
| 05018352001 | PH 2 | 10 | 100 | 111 | 4" |
| 05018354001 | PH 3 | 13 | 175 | 126 | 7" |
| 05018355001 | PH 4 | 16 | 200 | 140 | 8" |

955 SPZ Screwdriver for Pozidriv screws





Application: Suitable for Pozidriv screws
Blade: Round, hexagon bolster
Design: Chrome-plated, Black Point
Handle: Beech wood with leather cap

| |  mm |  mm |  mm |  mm |  mm |
|-------------|--|--|--|--|--|
| 05023305001 | PZ 1 | 8 | 90 | 102 | $3\frac{1}{2}$ " |
| 05023307001 | PZ 2 | 10 | 100 | 111 | 4" |
| 05023309001 | PZ 3 | 13 | 175 | 126 | 7" |

930/935/6 Screwdriver set





Application: Slotted and Phillips screws
Content: 6-piece set in display carton

| |  | |
|---|---|---|
| 05018251001 | | |
|  | 935 SPH | 1 x PH 1x90; 1 x PH 2x100 |
|  | 930 A | 1 x 0,6x3,5x90; 1 x 0,8x4,5x90; 1 x 1,0x5,5x100; 1 x 1,2x7,0x125 |

930/955/6 Screwdriver set



Application: Slotted and Pozidriv screws
Content: 6-piece set in display carton

| |  | |
|---|---|---|
| 05137810001 | | |
|  | 955 SPZ | 1 x PZ 1x90; 1 x PZ 2x100 |
|  | 930 A | 1 x 0,6x3,5x90; 1 x 0,8x4,5x90; 1 x 1,0x5,5x100; 1 x 1,2x7,0x125 |

Flagdriver Series

The right tool for every application



1267 A TORX® flagdriver for TORX® screws



Application: TORX® socket screws
Blade: Round
Design: BlackLaser surface
Handle: Multi-component

| | | mm | mm | mm | |
|-------------|-------|----|------|-----|----------|
| 05026350001 | TX 6 | 33 | 62,0 | 3,0 | 1 19/64" |
| 05026351001 | TX 7 | 33 | 62,0 | 3,0 | 1 19/64" |
| 05026352001 | TX 8 | 40 | 69,0 | 3,0 | 1 37/64" |
| 05026353001 | TX 9 | 40 | 69,0 | 3,0 | 1 37/64" |
| 05026354001 | TX 10 | 40 | 69,0 | 3,0 | 1 37/64" |

1267 B TORX® combination flagdriver for TORX® and hexagon socket screws

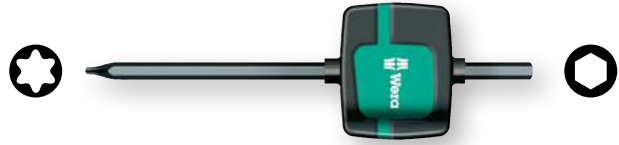

Application: TORX® and hexagon socket screws
Blade: Hexagon
Design: TORX® and hexagon, BlackLaser surface
Handle: Multi-component

| | | mm | mm | mm | |
|-------------|-------|-----|----|------|----------|
| 05026372001 | TX 15 | 3,5 | 47 | 86,0 | 1 27/32" |
| 05026373001 | TX 15 | 4 | 47 | 86,0 | 1 27/32" |
| 05026374001 | TX 20 | 4 | 47 | 86,0 | 1 27/32" |

1267 A TORX PLUS® flagdriver for TORX PLUS® screws



Application: TORX PLUS® socket screws
Blade: Round
Design: BlackLaser surface
Handle: Multi-component

| | | mm | mm | mm | |
|-------------|------|----|------|-----|----------|
| 05026360001 | 6 IP | 33 | 62,0 | 3,0 | 1 19/64" |
| 05026361001 | 7 IP | 33 | 62,0 | 3,0 | 1 19/64" |
| 05026363001 | 9 IP | 40 | 69,0 | 3,0 | 1 37/64" |

1267 B TORX PLUS® combination flagdriver for TORX PLUS® and hexagon socket screws



Application: TORX PLUS® and hexagon socket screws
Blade: Hexagon
Design: TORX PLUS® and hexagon, BlackLaser surface
Handle: Multi-component

| | | mm | mm | mm | |
|-------------|-------|-----|----|------|----------|
| 05026382001 | 15 IP | 3,5 | 47 | 86,0 | 1 27/32" |

Accessories

Indispensable aids for screwdriving jobs

Wera Star Magnetizer/Demagnetizer



Application: Simply run the tool down the positive side of the Wera magnetiser/demagnetiser and the tool immediately becomes magnetised and is able to hold the screw securely on the blade. To demagnetise the tool, simply run it down one of the four negative sides.

| | |
|---|----------|
|  | |
| 05073403001 | |
| Wera Star | 1 x 48,0 |



Magnetising

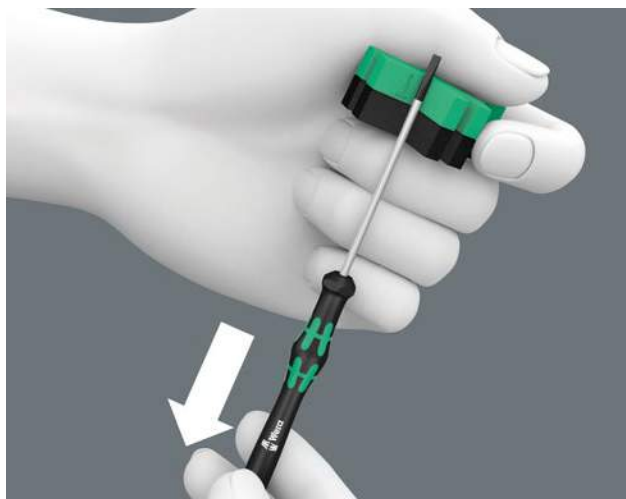



Demagnetising

1427 Awl



Handle: single-component

Blade: Extends through handle



| | | | |
|-------------|---|---|---|
| |  |  |  |
| | mm | mm | |
| 05027405001 | 105 | 92 | 4 3/16" |

1428 Reamer





Handle: single-component

Blade: Extends through handle

| | | | |
|-------------|---|---|---|
| |  |  |  |
| | mm | mm | |
| 05027455001 | 107 | 92 | 4 9/32" |

Rack for Kraftform Micro screwdrivers



| | | |
|-------------|---|---|
| |  |  |
| | mm | mm |
| 05134002001 | 190,0 | 80 |



Rack for Kraftform screwdrivers



| | | |
|-------------|-------|------|
| | | |
| | mm | mm |
| 05134001001 | 190,0 | 50,0 |

1440/1442 Screw gripper set



Application: Attachment with holding function for screws, holds all screw profiles and sizes securely on the tool, suitable for round and hexagon blades with a diameter from 4.5 mm to 6.0 mm and 6.0 mm to 8.5 mm

Design: Elastomer

| | | |
|-------------|------|--------------------|
| | | |
| 05073680001 | | |
| | 1440 | 1 x 4,5 - 6,0x41,0 |
| | 1442 | 1 x 6,0-8,5x41,0 |

1441 Screw gripper attachment for screwdriver blades, long bits and L-keys, with holding function for screws



Application: Attachment with holding function for screws, holds all screw profiles and sizes securely on the tool, suitable for round and hexagon blades with a diameter from 4.5 mm to 6.0 mm

Design: Elastomer

| | | |
|-------------|---------|------|
| | | |
| | mm | mm |
| 05073681001 | 4,5-6,0 | 41,0 |

And this is how the gripper works:



Push the screw gripper onto the tip of the screwdriver until the end of the blade protrudes from the rubber blade holder.



Attach the screw to the tip of the blade and secure it in the screw gripper.



Pull the screw gripper towards the screwdriver handle until the two arms of the gripper sit against the head of the screw and are spread slightly apart. The Wera screw gripper releases the screw automatically after it has been fastened.



The two gripper arms spread further apart as they are pushed against the surface and automatically snap back when the head of the screw is countersunk.

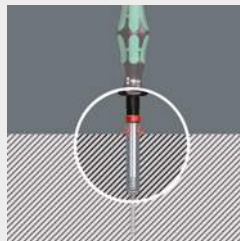

When fastening screws in blind holes the screw gripper is pushed back, making it possible to reach even deep-seated screws.



The screw gripper attachment can also be used with L-keys and long bits!

Kraftform Micro

Screwdriving jobs in electrical and precision engineering applications are often tedious and time-consuming.

We learned from users what is important for them: working speeds, torque, precision – and we then focused particularly on these issues.



The fast-turning zone just below the rotating cap allows rapid twisting.



The power zone has integrated soft zones near the blade tip to ensure high torque transfer for loosening or tightening screws without losing contact with the screw.



The precision zone directly above the blade gives the user a better feel for the right rotation angle during fine adjustment work.

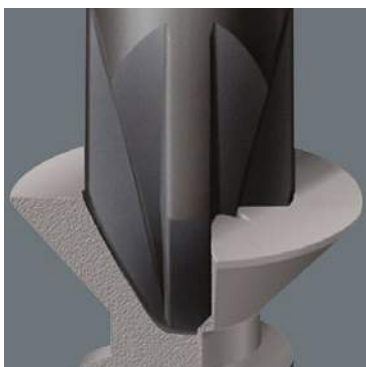
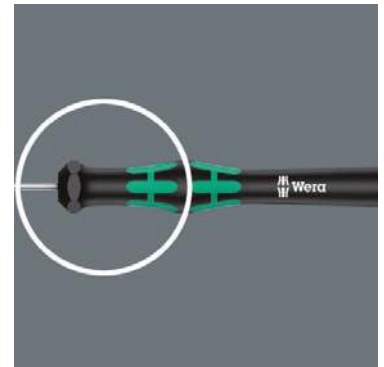

The Wera Black Point tip, as well as a refined hardening process, ensure long service life and enhanced corrosion protection.

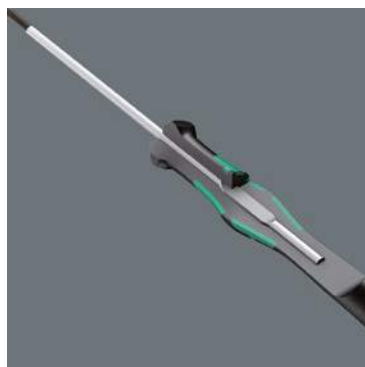

Multi-component screwdriver handle for ergonomic working.



Indispensable for many users, including electronics technicians, opticians, precision engineers, jewellers, EDP hardware fitters and model-makers.



Series Kraftform Micro

The refined screwdriver for electronics technicians

2035 Screwdriver for slotted screws for electronic applications



Application: Slotted screws
Blade: Round
Design: Chrome-plated, Black Point
Handle: Kraftform Micro with non-roll feature and rotating cap, multi-component

| | mm | mm | mm | mm | mm | mm | mm |
|-------------|------|-----|-----|----|-----|-------|---------|
| 05117990001 | 0,16 | 0,8 | 40 | 97 | 2,0 | 1/32" | 1 9/16" |
| 05117991001 | 0,18 | 1,0 | 40 | 97 | 2,0 | 0,04" | 1 9/16" |
| 05117992001 | 0,20 | 1,2 | 40 | 97 | 2,0 | 0,05" | 1 9/16" |
| 05118002001 | 0,23 | 1,5 | 40 | 97 | 2,0 | 1/16" | 1 9/16" |
| 05118003001 | 0,23 | 1,5 | 60 | 97 | 2,0 | 1/16" | 2 3/8" |
| 05118000001 | 0,25 | 1,2 | 40 | 97 | 2,0 | 0,05" | 1 9/16" |
| 05117993001 | 0,30 | 1,8 | 40 | 97 | 2,0 | 0,07" | 1 9/16" |
| 05118004001 | 0,30 | 1,8 | 60 | 97 | 2,0 | 0,07" | 2 3/8" |
| 05117997001 | 0,35 | 2,5 | 40 | 97 | 2,0 | 0,07" | 1 9/16" |
| 05118017001 | 0,30 | 2,0 | 50 | 97 | 2,0 | 0,07" | 2" |
| 05118005001 | 0,40 | 2,0 | 40 | 97 | 2,5 | 5/64" | 1 9/16" |
| 05118006001 | 0,40 | 2,0 | 60 | 97 | 2,5 | 5/64" | 2 3/8" |
| 05118007001 | 0,40 | 2,0 | 100 | 97 | 2,5 | 5/64" | 4" |
| 05117994001 | 0,40 | 2,5 | 50 | 97 | 2,5 | 3/32" | 2" |
| 05118008001 | 0,40 | 2,5 | 80 | 97 | 2,5 | 3/32" | 3 1/8" |
| 05117995001 | 0,50 | 3,0 | 50 | 97 | 3,0 | 1/8" | 2" |
| 05118010001 | 0,50 | 3,0 | 80 | 97 | 3,0 | 1/8" | 3 1/8" |
| 05118012001 | 0,60 | 3,5 | 80 | 97 | 4,0 | 9/64" | 3 1/8" |
| 05118014001 | 0,80 | 4,0 | 80 | 97 | 4,0 | 5/32" | 3 1/8" |

2055 PZ Screwdriver for Pozidriv screws for electronic applications



Application: Suitable for Pozidriv screws
Blade: Round
Design: Chrome-plated, Black Point
Handle: Kraftform Micro with non-roll feature and rotating cap, multi-component

| | | mm | mm | mm | mm |
|-------------|------|----|----|-----|---------|
| 05118030001 | PZ 0 | 60 | 97 | 3,0 | 2 3/8" |
| 05118032001 | PZ 1 | 80 | 97 | 4,0 | 3 1/16" |

2050 PH Screwdriver for Phillips screws for electronic applications



Application: Phillips screws
Blade: Round
Design: Chrome-plated, Black Point
Handle: Kraftform Micro with non-roll feature and rotating cap, multi-component

| | | mm | mm | mm | mm |
|------------------------------|--------|----|----|---------|---------|
| 05345290001 ^{1) 2)} | PH 000 | 40 | 97 | 1,5/2,5 | 1 9/16" |
| 05118019001 ^{1) 2)} | PH 00 | 40 | 97 | 1,8/2,5 | 1 9/16" |
| 05118020001 ¹⁾ | PH 00 | 60 | 97 | 2,5 | 2 3/8" |
| 05118026001 ²⁾ | PH 0 | 40 | 97 | 3,0 | 1 9/16" |
| 05118022001 ²⁾ | PH 0 | 60 | 97 | 3,0 | 2 3/8" |
| 05118023001 | PH 1 | 60 | 97 | 4,0 | 2 3/8" |
| 05118024001 | PH 1 | 80 | 97 | 4,0 | 3 1/8" |

¹⁾ Optimised for Asian PH screws

²⁾ Size 0 modified according to JCS 0 (Japanese Camera Industrial Standard)

³⁾ On the output side, the blade is turned to a nominal length of 10 mm.

2067 TORX® HF screwdriver with holding function for electronic applications



Application: TORX® socket screws
Blade: Round
Design: Holding function for TORX® screws made according to Acument Global Technologies Inc. specifications, chrome-plated, Black Point
Handle: Kraftform Micro with non-roll feature and rotating cap, multi-component

| | | mm | mm | mm | mm |
|-------------|-------|----|----|-----|---------|
| 05118180001 | TX 4 | 40 | 97 | 2,5 | 1 9/16" |
| 05118181001 | TX 5 | 40 | 97 | 3,0 | 1 9/16" |
| 05118182001 | TX 6 | 40 | 97 | 3,0 | 1 9/16" |
| 05118183001 | TX 7 | 60 | 97 | 3,0 | 2 3/8" |
| 05118184001 | TX 8 | 60 | 97 | 3,0 | 2 3/8" |
| 05118185001 | TX 9 | 60 | 97 | 4,0 | 2 3/8" |
| 05118186001 | TX 10 | 60 | 97 | 4,0 | 2 3/8" |



Tip

2067 TORX® screwdriver for TORX® screws for electronic applications



- Application:** TORX® socket screws
- Blade:** Round
- Design:** Chrome-plated, Black Point
- Handle:** Kraffform Micro with non-roll feature and rotating cap, multi-component

| | | mm | mm | mm | " |
|-------------|------|--------|--------|--------|---------|
| 05118035001 | TX 1 | 40 | 97 | 2,0 | 1 9/16" |
| 05118036001 | TX 2 | 40 | 97 | 2,0 | 1 9/16" |
| 05118037001 | TX 3 | 40 | 97 | 2,0 | 1 9/16" |
| 05118039001 | TX 4 | 40 | 97 | 2,5 | 1 9/16" |
| 05118040001 | TX 5 | 40 | 97 | 3,0 | 1 9/16" |
| 05118042001 | TX 6 | 40 | 97 | 3,0 | 1 9/16" |

2067 TORX® BO screwdriver for tamper-proof TORX® screws for electronic applications

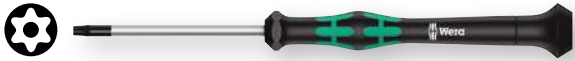

- Application:** TORX® socket screws with safety pin (BO = with bore hole)
- Blade:** Round
- Design:** Bore hole in TORX® section, chrome-plated, Black Point
- Handle:** Kraffform Micro with non-roll feature and rotating cap, multi-component

| | | mm | mm | mm | " |
|-------------|-------|--------|--------|--------|---------|
| 05118044001 | TX 7 | 60 | 97 | 3,0 | 1 9/16" |
| 05118046001 | TX 8 | 60 | 97 | 3,0 | 2 3/8" |
| 05118048001 | TX 9 | 60 | 97 | 4,0 | 2 3/8" |
| 05118050001 | TX 10 | 60 | 97 | 4,0 | 2 3/8" |
| 05118052001 | TX 15 | 60 | 97 | 4,0 | 2 3/8" |
| 05118054001 | TX 20 | 60 | 97 | 4,0 | 2 3/8" |

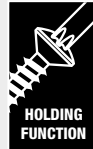

How can I hold my TORX® screw securely on the screwdriver?



The electronic TORX® screwdriver with holding function (HF) literally presses the screw onto the screwdriver. The conical driving flanks that taper toward the tip of the tool, the optimised flank base and the ideal engage depth hold the screw securely on the blade.

How to perform precision screwdriving jobs quickly whilst still applying the required degree of force?



The Kraffform Micro, with its three zones and their specific arrangement, satisfies these requirements perfectly. The free-turning cap that provides support for the hand works with these advantages, enabling quick and easy precision work.





Series Kraftform Micro

The refined screwdriver for electronics technicians

2067 IPR TORX PLUS® screwdriver for electronic applications







Application: TORX PLUS® IPR socket screws
Blade: Round
Design: Chrome-plated, Black Point
Handle: Kraftform Micro with non-roll feature and rotating cap, multi-component

| |  |  |  |  |  |
|-------------|---|---|---|---|---|
| | | mm | mm | mm | |
| 05030160001 | 1 IPR | 44 | 97 | 2,0 | 1 47/64" |

2054 Screwdriver for hexagon socket screws for electronic applications







Application: Hexagon socket screws
Blade: Round
Design: Hex-Plus, chrome-plated, Black Point
Handle: Kraftform Micro with non-roll feature and rotating cap, multi-component

| |  |  |  |  |  | |
|-------------|---|---|---|---|---|---------|
| | mm | mm | mm | mm | | |
| 05118060001 | 0,7 | 40 | 97 | 3,0 | 1 9/16" | |
| 05118062001 | 0,9 | 40 | 97 | 3,0 | 1 9/16" | |
| 05118064001 | 1,3 | 40 | 97 | 3,0 | 1 9/16" | |
| 05118066001 | 1,5 | 60 | 97 | 3,0 | 2 3/8" | |
| 05118068001 | 2 | 60 | 97 | 3,0 | 2 3/8" | |
| 05118070001 | 2,5 | 60 | 97 | 4,0 | 2 3/8" | |
| 05118072001 | 3,0 | 60 | 97 | 4,0 | 2 3/8" | |
| 05345284001 | - | 0,028" | 40 | 97 | 3,0 | 1 9/16" |
| 05345285001 | - | 0,035" | 40 | 97 | 3,0 | 1 9/16" |
| 05118074001 | - | 0,05" | 40 | 97 | 3,0 | 1 9/16" |
| 05118076001 | - | 1/16" | 60 | 97 | 3,0 | 2 3/8" |
| 05118078001 | - | 5/64" | 60 | 97 | 3,0 | 2 3/8" |
| 05118080001 | - | 3/32" | 60 | 97 | 4,0 | 2 3/8" |
| 05118082001 | - | 7/64" | 60 | 97 | 4,0 | 2 3/8" |
| 05118075001 | - | 1/8" | 60 | 97 | 4,0 | 2 3/8" |

2052 Ball end hexagon screwdriver for electronic applications







Application: Hexagon socket screws
Blade: Round
Design: Hexagon ball end, chrome-plated, Black Point
Handle: Kraftform Micro with non-roll feature and rotating cap, multi-component

| |  |  |  |  |  | |
|-------------|---|---|---|---|---|--------|
| | mm | mm | mm | mm | | |
| 05118089001 | 1,3 | 60 | 97 | 3,0 | 2 3/8" | |
| 05118090001 | 1,5 | 60 | 97 | 3,0 | 2 3/8" | |
| 05118092001 | 2,0 | 60 | 97 | 3,0 | 2 3/8" | |
| 05118094001 | 2,5 | 60 | 97 | 4,0 | 2 3/8" | |
| 05118096001 | 3,0 | 60 | 97 | 4,0 | 2 3/8" | |
| 05118098001 | - | 1/16" | 60 | 97 | 3,0 | 2 3/8" |
| 05118100001 | - | 5/64" | 60 | 97 | 3,0 | 2 3/8" |
| 05118102001 | - | 3/32" | 60 | 97 | 3,0 | 2 3/8" |
| 05118106001 | - | 7/64" | 60 | 97 | 4,0 | 2 3/8" |
| 05118103001 | - | 1/8" | 60 | 97 | 4,0 | 2 3/8" |

2072 Kraftform Micro screwdriver for Microstix® screws



Application: Microstix® socket screws
Blade: Round
Design: Chrome-plated, Black Point
Handle: Kraftform Micro with non-roll feature and rotating cap, multi-component







| |  |  |  |  |  |
|-------------|---|---|---|---|---|
| | mm | mm | mm | mm | |
| 05118145001 | m | 40 | 97 | 2,5 | 1 9/16" |



2069 Nutdriver for electronic applications







Application: Hexagon headed bolts, screws and nuts
Blade: Round
Design: Chrome-plated
Handle: Kraftform Micro with non-roll feature and rotating cap, multi-component

| |  |  |  |  |  |  |
|-------------|---|---|---|---|---|---|
| | mm | mm | mm | mm | mm | mm |
| 05118108001 | 1,5 | | 60 | 97 | 5,7 | 2 3/8" |
| 05118109001 | 1,8 | | 60 | 97 | 5,7 | 2 3/8" |
| 05118110001 | 2,0 | | 60 | 97 | 5,7 | 2 3/8" |
| 05118112001 | 2,5 | | 60 | 97 | 5,7 | 2 3/8" |
| 05118114001 | 3,0 | | 60 | 97 | 5,7 | 2 3/8" |
| 05118116001 | 3,2 | | 60 | 97 | 5,7 | 2 3/8" |
| 05118118001 | 3,5 | | 60 | 97 | 5,7 | 2 3/8" |
| 05118120001 | 4,0 | | 60 | 97 | 5,7 | 2 3/8" |
| 05118122001 | 4,5 | | 60 | 97 | 6,4 | 2 3/8" |
| 05118124001 | 5,0 | | 60 | 97 | 7,0 | 2 3/8" |
| 05118126001 | 5,5 | | 60 | 97 | 7,8 | 2 3/8" |
| 05345281001 | 6,0 | | 60 | 97 | 8,5 | 2 3/8" |
| 05118128001 | - | 3/32" | 60 | 97 | 5,7 | 2 3/8" |
| 05118130001 | - | 7/64" | 60 | 97 | 5,7 | 2 3/8" |
| 05118132001 | - | 1/8" | 60 | 97 | 5,7 | 2 3/8" |
| 05118134001 | - | 9/64" | 60 | 97 | 5,7 | 2 3/8" |
| 05118136001 | - | 5/32" | 60 | 97 | 5,7 | 2 3/8" |
| 05118135001 | - | 3/16" | 60 | 97 | 6,6 | 2 3/8" |
| 05118137001 | - | 7/32" | 60 | 97 | 7,8 | 2 3/8" |
| 05345282001 | - | 1/4" | 60 | 97 | 9,0 | 2 3/8" |

1429 Chip lifter



Application: Lifting tightly-fitting parts from circuit boards after desoldering
Blade: Round
Design: Chrome-plated
Handle: Kraftform Micro with non-roll feature and rotating cap, multi-component

| |  |  |  |  |
|-------------|---|---|---|---|
| | mm | mm | mm | mm |
| 05027456001 | 1,0 | 3,5 | 50 | 97 |

Tip

How to hold any screw securely on the screwdriver?



With the Wera magnetiser/demagnetiser: simply run the tool down the positive side of the Wera magnetiser/demagnetiser and the tool immediately becomes magnetised and is able to hold the screw securely on the blade.

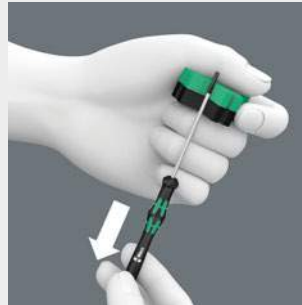

To demagnetise the tool, simply run it down one of the four negative sides. See page 62.



Hexagon ball tip



The spherical drive profile means that it is possible to swivel the axis of the tool to that of the screw, and therefore enable angled, "around-the-corner" screw-driving jobs.

Series Kraftform Micro

The refined screwdriver for electronics technicians

1013 Kraftform Micro bitholding screwdriver

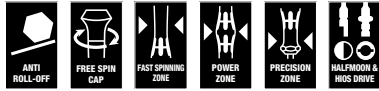

Application: Suitable for bits with 4 mm Halfmoon drive (and Wera Serie 9) and 4 mm HIOS drive (and Wera Series 21)

Design: With quick-release chuck for rapid bit change

Handle: Kraftform Micro with non-roll feature and rotating cap, multi-component

| | mm | mm | " |
|-------------|----|----|----|
| 05051276001 | 23 | 97 | 1" |

Kraftform Micro 12 Electronics 1 Screwdriver set for electronic applications



Application: Slotted, Phillips, TORX® BO, TORX PLUS® IPR, Microstix® screws and hexagon headed bolts, screws and nuts. 1 remover.

Content: 12-piece set, in a belt pouch

Kraftform Micro 12 Universal 1 Screwdriver set for electronic applications



Application: Slotted and Phillips screws, TORX® socket screws, and Hexagon socket screws

Content: 12-piece set, in a belt pouch

| 05073677001 | | |
|-------------|---------------------|--|
| + | 2050 PH Micro | 1 x PH 000x40 ¹⁾ ; 1 x PH 00x40 ¹⁾ ; 1 x PH 0x40 ²⁾ |
| ⊕ | 2067 TORX® BO Micro | 1 x TX 8x60; 1 x TX 10x60 |
| ⊗ | 2067 IPR Micro | 1 x 1 IPR x 44 |
| ⊖ | 2035 Micro | 1 x 0,23x1,5x40; 1 x 0,35x2,5x40 |
| ⦿ | 2069 Micro | 1 x 2,5x60; 1 x 3,0x60 |
| + | 2072 | 1 x mx40 |
| ● | 1429 | 1 x 1,0x3,5x50 |

¹⁾ Optimised for Asian PH screws

²⁾ Size 0 modified according to JCIS 0 (Japanese Camera Industrial Standard)

| 05073675001 | | |
|-------------|---------------|---|
| + | 2050 PH Micro | 1 x PH 00x60 ¹⁾ ; 1 x PH 0x60 ²⁾ |
| ⊕ | 2067 TORX® HF | 1 x TX 5x40; 1 x TX 6x40 |
| ⊖ | 2035 Micro | 1 x 0,23x1,5x40; 1 x 0,30x1,8x60; 1 x 0,40x2,0x60; 1 x 0,40x2,5x80; 1 x 0,50x3,0x80 |
| ○ | 2054 Micro | 1 x 0,9x40; 1 x 1,5x60; 1 x 2x60 |

¹⁾ Optimised for Asian PH screws

²⁾ Size 0 modified according to JCIS 0 (Japanese Camera Industrial Standard)



Kraftform Kompakt Micro 11 Electronics 1



11-piece set
Pouch with 44 mm bits
1 Kraftform Micro bitholding screwdriver 1013

| | |
|------------------------|--|
| 05073676001 | |
| 1013 | 1 x 97 |
| Kraftform Micro | |
| 851/9 C | 1 x PH 000x44 ¹⁾ ; 1 x PH 00x44 ¹⁾ ; 1 x PH 0x44 ²⁾ |
| 867/9 C | 1 x TX 8x44 |
| TORX® | |
| 867/9 C TORX PLUS® | 1 x 3 IPx44 |
| 867/9 IPR | 1 x 1 IPRx44 |
| TORX® PLUS | |
| 800/9 C | 1 x 0,35x2,5x44 |
| 872/9 | 1 x mx44 |
| 869/9 | 1 x 2,5x44,0; 1 x 3,0x44,0 |

¹⁾ Optimised for Asian PH screws
²⁾ Size 0 modified according to JCIS 0 (Japanese Camera Industrial Standard)

Kraftform Kompakt Micro 11 Universal 1



11-piece set
Pouch with 44 mm bits
1 Kraftform Micro bitholding screwdriver 1013

| | |
|------------------------|--|
| 05135938001 | |
| 1013 | 1 x 97 |
| Kraftform Micro | |
| 851/9 C | 1 x PH 00x44 ¹⁾ ; 1 x PH 0x44 ²⁾ ; 1 x PH 1x44 ¹⁾ |
| 840/9 C | 1 x 1,5x44; 1 x 2,0x44 |
| 800/9 C | 1 x 0,23x1,5x44; 1 x 0,40x2,0x44; 1 x 0,50x3,0x44 |
| 867/9 C | 1 x TX 5x44; 1 x TX 6x44 |
| TORX® | |

¹⁾ Optimised for Asian PH screws
²⁾ Size 0 modified according to JCIS 0 (Japanese Camera Industrial Standard)

2035/6 A Screwdriver set and rack for electronic applications



Application: Slotted and Phillips screws
Content: 6-piece set and rack in display carton

| | |
|---------------|--|
| 05118150001 | |
| 2050 PH Micro | 1 x PH 00x60 ¹⁾ ; 1 x PH 0x60 ²⁾ |
| 2035 Micro | 1 x 0,30x1,8x60; 1 x 0,40x2,0x60; 1 x 0,40x2,5x80; 1 x 0,50x3,0x80 |

¹⁾ Optimised for Asian PH screws
²⁾ Size 0 modified according to JCIS 0 (Japanese Camera Industrial Standard)

Series Kraftform Micro

The refined screwdriver for electronics technicians

2035/6 B Screwdriver set and rack for electronic applications



Application: Slotted and Phillips screws
Content: 6-piece set and rack in display carton

| | |
|-------------|--|
| | |
| 05118152001 | |
| | 2050 PH Micro 1 x PH 0x60 ¹⁾ ; 1 x PH 1x80 |
| | 2035 Micro 1 x 0,40x2,5x80; 1 x 0,50x3,0x80; 1 x 0,60x3,5x80; 1 x 0,80x4,0x80 |

¹⁾ Size 0 modified according to JCIS 0 (Japanese Camera Industrial Standard)

2050/6 Screwdriver set and rack for electronic applications



Application: Slotted, Phillips, TORX PLUS® IPR and Microstix® screws
Content: 6-piece set and rack in display carton

| | |
|-------------|--|
| | |
| 05030181001 | |
| | 2050 PH Micro 1 x PH 000x40 ¹⁾ ; 1 x PH 00x40 ¹⁾ ; 1 x PH 0x40 ²⁾ |
| | 2067 IPR 1 x 1 IPR x 44 |
| | Micro |
| | 2072 1 x mx40 |
| | 2035 Micro 1 x 0,35x2,5x40 |

¹⁾ Optimised for Asian PH screws

²⁾ Size 0 modified according to JCIS 0 (Japanese Camera Industrial Standard)

2052/6 Hexagon screwdriver set and rack for electronic applications



Application: Ball end for hexagon socket screws
Content: 6-piece set and rack in display carton

| | |
|-------------|---|
| | |
| 05118156001 | |
| | 2052 Micro 1 x 1,5x60; 1 x 2,0x60; 1 x 2,5x60; 1 x 3,0x60 |
| | 2054 Micro 1 x 0,9x40; 1 x 1,3x40 |



2067/6 TORX® BO screwdriver set and rack for electronic applications



Application: TORX® socket screws with safety pin (BO = with bore hole)
Content: 6-piece set and rack in display carton

| | |
|----------------------------|--|
| | |
| 05118154001 | |
| 2067 TORX® BO Micro | 1 x TX 7x60; 1 x TX 8x60; 1 x TX 9x60; 1 x TX 10x60; 1 x TX 15x60; 1 x TX 20x60 |

2069/6 Screwdriver set and rack for electronic applications



Application: Hexagon headed bolts, screws and nuts
Content: 6-piece set and rack in display carton

| | |
|-------------------|---|
| | |
| 05118158001 | |
| 2069 Micro | 1 x 2,0x60; 1 x 2,5x60; 1 x 3,0x60; 1 x 3,5x60; 1 x 4,0x60; 1 x 5,0x60 |



Screwdrivers with T-handle

The T-handle is useful whenever higher tightening or loosening torque need to be applied.

The exclusive use of hard material in combination with the large contact surface area in the hand ensures an efficient, positive transfer of power.



The ergonomic design of the T-handle fills the palm of the hand. The fingers rest in the soft, rounded recess, and the whole hand is in contact with the handle – so there is no friction loss between the hand and handle.

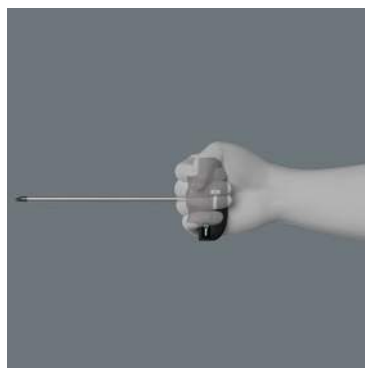

By using the blade as an extension of your lower arm you can transfer particularly high torque.

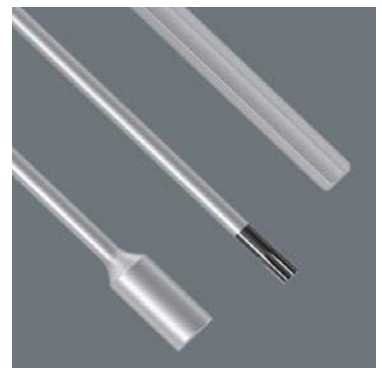

The blades are made for superior wear resistance and robustness.







Series 400 T-Handle

Ideal for high torque

454 T-handle hexdriver







Application: Hexagon socket screws
Blade: Hexagon
Design: Hex-Plus, chamfered, chrome-plated
Handle: T-handle, single-component

| |  |  mm |  mm |  mm |  " |
|-------------|---|---|---|---|--|
| 05013300001 | 2 | 100 | 27 | 61 | 4" |
| 05013301001 | 2 | 200 | 27 | 61 | 8" |
| 05013302001 | 2,5 | 100 | 27 | 61 | 4" |
| 05013303001 | 2,5 | 200 | 27 | 61 | 8" |
| 05013304001 | 3 | 100 | 33 | 70 | 4" |
| 05013305001 | 3 | 150 | 33 | 70 | 6" |
| 05013330001 | 3 | 200 | 33 | 70 | 8" |
| 05013331001 | 3 | 350 | 33 | 70 | 14" |
| 05013332001 | 4 | 100 | 33 | 70 | 4" |
| 05013306001 | 4 | 150 | 33 | 70 | 6" |
| 05013307001 | 4 | 200 | 33 | 70 | 8" |
| 05013333001 | 4 | 350 | 33 | 70 | 14" |
| 05013334001 | 5 | 100 | 44 | 87 | 4" |
| 05013308001 | 5 | 150 | 44 | 87 | 6" |
| 05013309001 | 5 | 200 | 44 | 87 | 8" |
| 05013335001 | 5 | 350 | 44 | 87 | 18" |
| 05013337001 | 6 | 100 | 44 | 87 | 4" |
| 05013338001 | 6 | 150 | 44 | 87 | 6" |
| 05013310001 | 6 | 200 | 44 | 87 | 8" |
| 05013339001 | 6 | 350 | 44 | 87 | 14" |
| 05013311001 | 7 | 200 | 44 | 87 | 8" |
| 05013341001 | 8 | 150 | 44 | 87 | 6" |
| 05013312001 | 8 | 200 | 44 | 87 | 8" |
| 05013314001 | 10 | 200 | 44 | 87 | 8" |

454 T-handle hexdriver, imperial









Application: Hexagon socket screws
Blade: Hexagon
Design: Hex-Plus, chamfered, BlackLaser surface
Handle: T-handle, single-component

| |  |  mm |  mm |  mm |  " |
|-------------|---|---|---|---|--|
| 05344536001 | $\frac{3}{32}$ " | 100 | 27 | 61 | 4" |
| 05344537001 | $\frac{7}{64}$ " | 100 | 27 | 61 | 4" |
| 05344538001 | $\frac{1}{8}$ " | 100 | 33 | 70 | 4" |
| 05344546001 | $\frac{9}{64}$ " | 150 | 33 | 70 | 6" |
| 05344545001 | $\frac{5}{32}$ " | 150 | 33 | 70 | 6" |
| 05344544001 | $\frac{3}{16}$ " | 150 | 44 | 87 | 6" |
| 05344543001 | $\frac{7}{32}$ " | 150 | 44 | 87 | 6" |
| 05344542001 | $\frac{1}{4}$ " | 200 | 44 | 87 | 8" |
| 05344541001 | $\frac{5}{16}$ " | 200 | 44 | 87 | 8" |
| 05344540001 | $\frac{3}{8}$ " | 200 | 44 | 87 | 8" |

467 T-handle TORX® driver



Application: TORX® screws
Blade: Round
Design: Chrome-plated, Black Point
Handle: T-handle, single-component

| |  |  mm |  mm |  mm |  " |  mm |
|-------------|---|---|---|---|--|---|
| 05013350001 | TX 6 | 100 | 27 | 61 | 4" | 3,0 |
| 05013352001 | TX 7 | 100 | 27 | 61 | 4" | 3,0 |
| 05013354001 | TX 8 | 100 | 27 | 61 | 4" | 3,5 |
| 05013356001 | TX 9 | 100 | 27 | 61 | 4" | 3,5 |
| 05013358001 | TX 10 | 100 | 27 | 61 | 4" | 4,0 |
| 05013360001 | TX 15 | 100 | 33 | 70 | 4" | 4,0 |
| 05013362001 | TX 20 | 100 | 33 | 70 | 4" | 4,5 |
| 05013364001 | TX 20 | 200 | 33 | 70 | 8" | 4,5 |
| 05013366001 | TX 25 | 100 | 33 | 70 | 4" | 5,0 |
| 05013368001 | TX 25 | 200 | 33 | 70 | 8" | 5,0 |
| 05013370001 | TX 27 | 200 | 44 | 87 | 8" | 6,0 |
| 05013372001 | TX 30 | 200 | 44 | 87 | 8" | 6,0 |
| 05013374001 | TX 40 | 200 | 44 | 87 | 8" | 8,0 |
| 05013376001 | TX 45 | 200 | 44 | 87 | 8" | 9,0 |



495 T-handle nutspinner



Application: Hexagon headed bolts, screws and nuts
Blade: Round
Design: Hexagonal, chrome-plated
Handle: T-handle, single-component

| | | mm | mm | mm | mm | mm | mm |
|-------------|-----|-----|----|----|----|----|------|
| 05013400001 | 5 | 230 | 33 | 70 | 9" | | 8,1 |
| 05013399001 | 5,5 | 230 | 33 | 70 | 9" | | 8,1 |
| 05013401001 | 6 | 230 | 33 | 70 | 9" | | 9,1 |
| 05013402001 | 7 | 230 | 44 | 87 | 9" | | 11,0 |
| 05013403001 | 8 | 230 | 44 | 87 | 9" | | 12,1 |
| 05013404001 | 9 | 230 | 44 | 87 | 9" | | 13,1 |
| 05013405001 | 10 | 230 | 44 | 87 | 9" | | 14,1 |
| 05013407001 | 11 | 230 | 44 | 87 | 9" | | 16,0 |
| 05013409001 | 12 | 230 | 44 | 87 | 9" | | 17,1 |
| 05013411001 | 13 | 230 | 44 | 87 | 9" | | 18,1 |

489 R T-handle Rapidaptor



Application: Suitable for 1/4" DIN ISO 1173-C 6,3 and E 6,3 hexagon insert bits and Wera Series 1 and 4

Drive: 1/4" hexagon with Rapidaptor rapid-in, rapid-out, rapid-spin, chuck-all and single-hand technology, magnetic

Handle: T-handle, multi-component

| | | mm | mm | mm | mm | mm |
|-------------|------|----|----|----|----------|----|
| 05013390001 | 1/4" | 45 | 44 | 87 | 1 25/32" | |

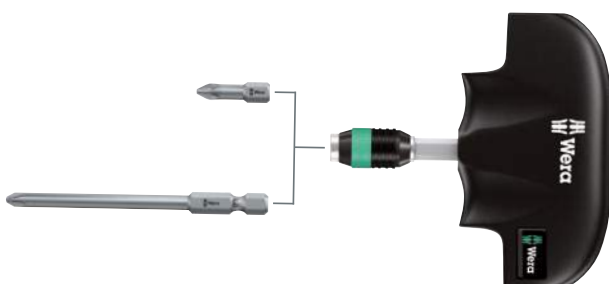

Rapidaptor

Rapid-in and self-lock



The bit can be pushed into the adaptor without moving the sleeve. The lock is activated automatically as soon as the bit is applied to the screw. Bits are held securely and wobble-free.

Rapid-out



Simply push the sleeve forward to change the bit. The spring mechanism lifts the bit off the magnet and unlocks the tool. The bit can be easily removed. The rapid-out function makes it easy to remove even the smallest bits without extra tools.

Chuck-all



The Rapidaptor quick-release chucks hold 1/4" DIN ISO 1173-C 6,3 and E 6,3 as well as Wera series 1 and 4 bits.

Single-hand function



Every function of the Rapidaptor quick-release chuck, such as inserting or releasing bits, can be carried out with one hand. This is faster, more economical and more ergonomic. There are no unnecessary manoeuvres.

ESD Tools

When doing screwdriving jobs on electronic components (like e.g. smartphones and tablet PCs), there should be no electrostatic discharge as this could cause malfunctions and a complete failure.

Therefore, tools that are secure against electrostatic discharge are indispensable.



The requirements for ESD-safe screwdrivers are specified in the European standard DIN EN 61340-5-1. This standard also includes a handle that has to be out of a defined conductive material. The Wera products in the ESD series satisfy these standards and the even more stringent requirements demanded by some technology companies.

The electric surface resistance of the Wera ESD material is $\leq 10^9$ ohm. This securely protects components against electrostatic energy and associated damage.

Wera Black Point tips and a refined hardening process ensure long service life of the tip, improved corrosion protection and an exact fit.

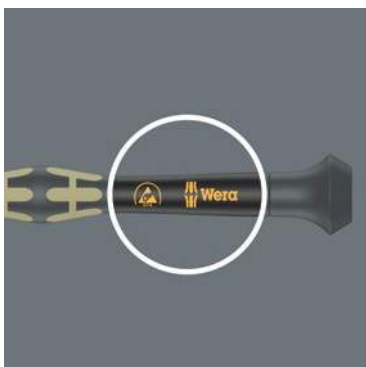
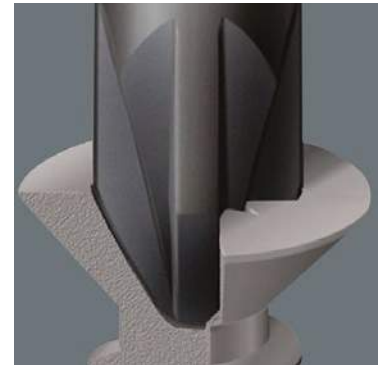

The fast-turning zone just below the rotating allows rapid twisting.



The power zone has integrated soft zones near the blade tip to ensure high torque transfer for loosening or tightening screws without losing contact with the screw.

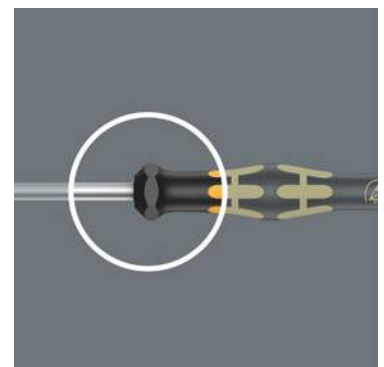

The precision zone directly above the blade gives the user a better feel for the right rotation angle during fine adjustment work.

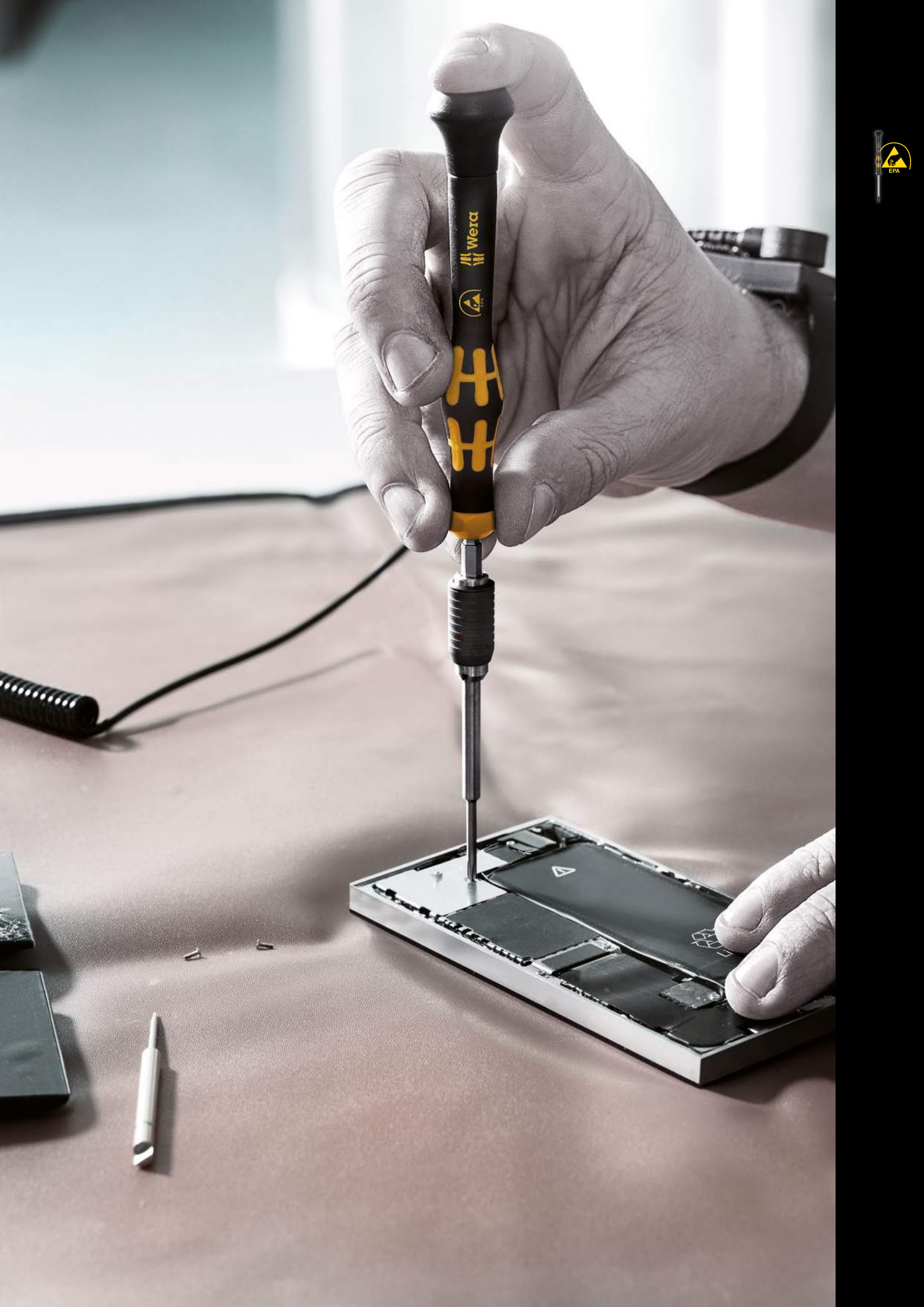







ESD Series

ESD-safe tools

1578 A Kraftform Micro screwdriver for slotted screws







Application: Slotted screws
Blade: Round
Design: Chrome-plated, Black Point
Handle: Kraftform Micro with non-roll feature and rotating cap, multi-component

| |  |  |  |  |  |  |  |
|-------------|---|---|---|---|---|---|---|
| | mm | mm | mm | mm | mm | " | " |
| 05030101001 | 0,23 | 1,5 | 40 | 97 | 2,5 | 1/16" | 1 9/16" |
| 05030100001 | 0,25 | 1,2 | 40 | 97 | 2,5 | 0,05" | 1 9/16" |
| 05030102001 | 0,30 | 1,8 | 60 | 97 | 2,5 | 0,07" | 2 3/8" |
| 05030108001 | 0,35 | 2,5 | 40 | 97 | 2,5 | 3/32" | 1 9/16" |
| 05030103001 | 0,40 | 2,0 | 60 | 97 | 2,5 | 5/64" | 2 3/8" |
| 05030104001 | 0,40 | 2,5 | 80 | 97 | 2,5 | 3/32" | 3 1/8" |
| 05030105001 | 0,50 | 3,0 | 80 | 97 | 3,0 | 1/8" | 3 1/8" |
| 05030106001 | 0,60 | 3,5 | 80 | 97 | 4,0 | 9/64" | 3 1/8" |
| 05030107001 | 0,80 | 4,0 | 80 | 97 | 4,0 | 5/32" | 3 1/8" |

1550 PH Kraftform Micro screwdriver for Phillips screws



Application: Phillips screws
Blade: Round
Design: Chrome-plated, Black Point
Handle: Kraftform Micro with non-roll feature and rotating cap, multi-component

| |  |  |  |  |  |
|------------------------------|---|---|---|---|---|
| | mm | mm | mm | mm | " |
| 05030117001 ¹⁾ 3) | PH 000 | 40 | 97 | 1,5/2,5 | 1 9/16" |
| 05030118001 ¹⁾ 3) | PH 00 | 40 | 97 | 1,8/2,5 | 1 9/16" |
| 05030110001 ³⁾ | PH 00 | 60 | 97 | 1,8/2,5 | 2 3/8" |
| 05030119001 | PH 0 | 40 | 97 | 3,0 | 1 9/16" |
| 05030111001 ²⁾ | PH 0 | 60 | 97 | 3,0 | 2 3/8" |
| 05030112001 | PH 1 | 80 | 97 | 4,0 | 3 1/8" |

¹⁾ Optimised for Asian PH screws





²⁾ Size 0 modified according to JCIS 0 (Japanese Camera Industrial Standard)

³⁾ On the output side, the blade is turned to a nominal length of 10 mm.

1555 PZ Kraftform Micro screwdriver for Pozidriv screws







Application: Suitable for Pozidriv screws
Blade: Round
Design: Chrome-plated, Black Point
Handle: Kraftform Micro with non-roll feature and rotating cap, multi-component

| |  |  |  |  |  |
|-------------|---|---|---|---|---|
| | mm | mm | mm | mm | " |
| 05030115001 | PZ 0 | 60 | 97 | 3,0 | 2 3/8" |
| 05030116001 | PZ 1 | 80 | 97 | 4,0 | 3 1/8" |

1567 TORX® HF Kraftform Micro screwdriver with holding function for TORX® screws



Application: TORX® socket screws
Blade: Round
Design: Holding function for TORX® screws made according to Acument Intellectual Properties specifications, chrome-plated, Black Point
Handle: Kraftform Micro with non-roll feature and rotating cap, multi-component

| |  |  |  |  |  |
|-------------|---|---|---|---|---|
| | mm | mm | mm | mm | " |
| 05030400001 | TX 4 | 40 | 97 | 2,5 | 1 9/16" |
| 05030401001 | TX 5 | 40 | 97 | 3,0 | 1 9/16" |
| 05030402001 | TX 6 | 40 | 97 | 3,0 | 1 9/16" |
| 05030403001 | TX 7 | 60 | 97 | 3,0 | 2 3/8" |
| 05030404001 | TX 8 | 60 | 97 | 3,0 | 2 3/8" |
| 05030405001 | TX 9 | 60 | 97 | 4,0 | 2 3/8" |
| 05030406001 | TX 10 | 60 | 97 | 4,0 | 2 3/8" |



1567 TORX® Kraftform Micro screwdriver for TORX® screws



Application: TORX® socket screws
Blade: Round
Design: Chrome-plated, Black Point
Handle: Kraftform Micro with non-roll feature and rotating cap, multi-component

| | | mm | mm | mm | mm |
|-------------|------|----|----|-----|---------|
| 05030120001 | TX 4 | 40 | 97 | 2,5 | 1 9/16" |
| 05030121001 | TX 5 | 40 | 97 | 3,0 | 1 9/16" |
| 05030122001 | TX 6 | 40 | 97 | 3,0 | 1 9/16" |

1567 TORX® BO Screwdriver for tamper-proof TORX® screws



Application: TORX® socket screws with safety pin (BO = with bore hole)
Blade: Round
Design: Bore hole in TORX® section, chrome-plated, Black Point
Handle: Kraftform with non-roll feature, single-component

| | | mm | mm | mm | mm |
|-------------|-------|-----|----|-----|---------|
| 05030131001 | TX 10 | 80 | 81 | 4,0 | 3 1/8" |
| 05030127001 | TX 15 | 80 | 98 | 4,0 | 3 1/8" |
| 05030128001 | TX 20 | 100 | 98 | 4,5 | 4" |
| 05030129001 | TX 25 | 100 | 98 | 5,0 | 4" |
| 05030130001 | TX 30 | 115 | 98 | 6,0 | 4 9/16" |

1567 IPR TORX PLUS® screwdriver for electronic applications



Application: TORX PLUS® IPR socket screws
Blade: Round
Design: Chrome-plated, Black Point
Handle: Kraftform Micro with non-roll feature and rotating cap, multi-component

| | | mm | mm | mm | mm |
|-------------|-------|----|----|-----|---------|
| 05030135001 | 1 IPR | 40 | 97 | 2,0 | 1 9/16" |

Tip

Rotating cap and fast-turning zone



The fast-turning zone just below the rotating cap allow rapid twisting. This makes time-consuming grip adjustments as with other conventional precision screwdrivers unnecessary.

The power zone

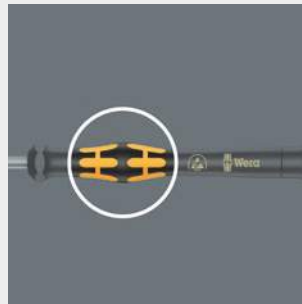

The power zone has integrated soft zones near the blade tip to ensure high torque transfer for loosening or tightening screws without losing contact with the screw.

The precision zone

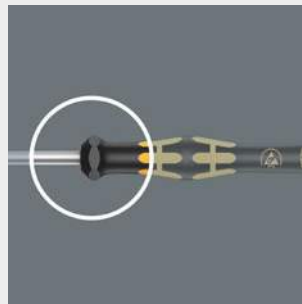

The precision zone directly above the blade gives the user a better feel for the right rotation angle during fine adjustment work.

ESD Series

ESD-safe tools

1572 ESD Krafftform Micro screwdriver for Microstix® screws



Application: Microstix® socket screws
Blade: Round
Design: Chrome-plated, Black Point
Handle: Krafftform Micro with non-roll feature and rotating cap, multi-component

| | | mm | mm | mm | " |
|-------------|----|----|----|-----|---------|
| 05030080001 | m | 40 | 97 | 2,5 | 1 9/16" |
| 05030081001 | 00 | 40 | 97 | 2,5 | 1 9/16" |
| 05030082001 | F | 40 | 97 | 2,5 | 1 9/16" |
| 05030083001 | 0 | 40 | 97 | 2,5 | 1 9/16" |
| 05030084001 | 1 | 40 | 97 | 2,5 | 1 9/16" |

1569 ESD Nutdriver



Application: Hexagon headed bolts, screws and nuts
Blade: Round
Design: Chrome-plated
Handle: Krafftform Micro with non-roll feature and rotating cap, multi-component

| | | mm | mm | mm | " |
|-------------|-----|----|----|-----|--------|
| 05030410001 | 1,5 | 60 | 97 | 5,7 | 2 3/8" |
| 05030411001 | 1,8 | 60 | 97 | 5,7 | 2 3/8" |
| 05030412001 | 2,0 | 60 | 97 | 5,7 | 2 3/8" |
| 05030413001 | 2,5 | 60 | 97 | 5,7 | 2 3/8" |
| 05030414001 | 3,0 | 60 | 97 | 5,7 | 2 3/8" |
| 05030415001 | 3,2 | 60 | 97 | 5,7 | 2 3/8" |
| 05030416001 | 3,5 | 60 | 97 | 5,7 | 2 3/8" |
| 05030417001 | 4,0 | 60 | 97 | 5,7 | 2 3/8" |
| 05030418001 | 4,5 | 60 | 97 | 6,4 | 2 3/8" |
| 05030150001 | 5,0 | 60 | 97 | 7,0 | 2 3/8" |
| 05030151001 | 5,5 | 60 | 97 | 7,8 | 2 3/8" |

1578 A/6 ESD Screwdriver set and rack for electronic applications



Application: Slotted and Phillips screws
Content: 6-piece set and rack in display carton

| 05030170001 | |
|-------------|--|
| | 1550 PH Micro 1 x PH 0x60; 1 x PH 1x80 |
| | 1578 A Micro 1 x 0,23x1,5x40; 1 x 0,25x1,2x40; 1 x 0,30x1,8x60; 1 x 0,40x2,5x80 |

1550/6 ESD Screwdriver set and rack for electronic applications



Application: Slotted, Phillips and Microstix® screws
Content: 6-piece set and rack in display carton

| 05030180001 | |
|-------------|---|
| | 1550 PH Micro 1 x PH 000x40 ¹⁾ ; 1 x PH 00x40 ¹⁾ ; 1 x PH 0x40 |
| | 1578 A Micro 1 x 0,25x1,2x40; 1 x 0,35x2,5x40 |
| | 1572 ESD 1 x mx40 |

¹⁾ Optimised for Asian PH screws



1013 Kraffform Micro ESD bitholding screwdriver



Application: Suitable for bits with 4 mm Halfmoon drive (and Wera Serie 9) and 4 mm HIOS drive (and Wera Series 21)

Design: With quick-release chuck for rapid bit change

Handle: Kraffform Micro with non-roll feature and rotating cap, multi-component

| |  mm |  mm |  " |
|-------------|---|---|--|
| 05300004001 | 23 | 97 | 1" |



816 R ESD bitholding screwdriver, non-magnetic



Application: Suitable for 1/4" DIN ISO 1173-C and E 6,3 hexagon insert bits and Wera Series 1 and 4

Design: 1/4" hexagon socket with Wera quick-release chuck and Rapidaptor rapid-in, rapid-out, rapid-spin, chuck-all and single-hand technology

Handle: Kraffform with non-roll feature, multi-component

| |  " |  mm |
|-------------|--|---|
| 05051464001 | 1/4" | 119 |

Tip

Chuck-all



The Rapidaptor quick-release chucks hold both 1/4" bits as per DIN ISO 1173-C 6,3 (Wera series 1) and E 6,3 (Wera series 4).

Single-hand



All functions of the quick-release chuck such as the inserting or releasing of bits can be done with just one hand. That is faster, more economic and ergonomic. There are no unnecessary manoeuvres.

Rapid-in and self-lock



The bit can be pushed into the chuck without moving the sleeve. It automatically locks with a secure and wobble-free fit as soon as the bit is applied to the screw.

Rapid-out



Simply push the sleeve forward to change the bit. The spring mechanism lifts the bit off the magnet and unlocks the tool. The bit can be easily removed. Particularly helpful: even the smallest bits can be removed without any extra tools.



ESD Series

ESD-safe tools

813 R ESD bitholding screwdriver, non-magnetic



Application: Suitable for 1/4" DIN ISO 1173-C and E 6,3 hexagon insert bits and Wera Series 1 and 4

Design: 1/4" hexagon socket with Wera quick-release chuck and Rapidaptor rapid-in, rapid-out, rapid-spin, chuck-all and single-hand technology

Handle: Kraftform with non-roll feature, multi-component

| | | |
|-------------|------|----|
| | | |
| 05051273001 | 1/4" | 90 |

Kraftform Kompakt 60 ESD



Pouch with 89 mm bits

17-piece set

1 Kraftform bitholding screwdriver 816 R ESD with Rapidaptor quick-release chuck

| | | |
|-------------|-------------------------|--|
| 05051043001 | | |
| | 816 R ESD | 1 x 1/4"x119 |
| | 851/4 Z PH | 1 x PH 1x89; 1 x PH 2x89; 1 x PH 3x89 |
| | 855/4 Z PZ | 1 x PZ 1x89; 1 x PZ 2x89; 1 x PZ 3x89 |
| | 867/4 Z TORX® | 1 x TX 10x89; 1 x TX 15x89; 1 x TX 20x89; 1 x TX 25x89; 1 x TX 30x89 |
| | 840/4 Z Hex-Plus | 1 x 3,0x89; 1 x 4,0x89; 1 x 5,0x89; 1 x 6,0x89 |
| | 800/4 Z | 1 x 1,0x5,5x89 |

Kraftform Kompakt Micro 21 ESD 1



21-piece set

Pouch with 44 mm bits

1 Kraftform Micro ESD bitholding screwdriver

| | | |
|-------------|---------------------------------|--|
| 05135973001 | | |
| | 1013 Kraftform Micro ESD | 1 x 97 |
| | 851/9 C | 1 x PH 000x44 ¹⁾ ; 1 x PH 00x44 ¹⁾ ; 1 x PH 0x44 ²⁾ |
| | 867/9 C TORX® | 1 x TX 1x44; 1 x TX 2x44; 1 x TX 3x44; 1 x TX 4x44; 1 x TX 5x44 |
| | 867/9 C TORX PLUS® | 1 x 1 IPx44; 1 x 2 IPx44; 1 x 3 IPx44; 1 x 4 IPx44 |
| | 867/9 IPR TORX® PLUS | 1 x 1 IPRx44 |
| | 872/9 | 1 x mx44; 1 x 00x44; 1 x Fx44; 1 x 0x44 |
| | 800/9 C | 1 x 0,23x1,5x44; 1 x 0,35x2,5x44 |
| | 869/9 | 1 x 2,5x44,0 |





¹⁾ Optimised for Asian PH screws

²⁾ Size 0 modified according to JCIS 0 (Japanese Camera Industrial Standard)



VDE Tools



| | | |
|--|--|------------|
|  | Kraftform Stainless VDE | 88 |
|  | Kraftform Series 100 VDE | 92 |
|  | Kraftform Kompakt VDE | 106 |
|  | Kraftform Comfort VDE | 120 |
|  | The Zyklop VDE Ratchet and accessories | 124 |

Kraftform Stainless Screwdrivers VDE

Why are stainless elements so often affected by rust? One reason: screwdriving jobs are often carried out with a tool out of made from conventional steel which can result in extraneous rust forming. This is annoying. We were confident that this could be prevented by using tools likewise out of stainless steel and meeting the required standard of industrial hardness.

A tool series out of stainless steel. The forming of extraneous rust is prevented and a special vacuum ice-hardening process ensures the required degree of hardness – and they are even VDE-tested, too.



Solution to the rust problem: screw stainless steel together with stainless steel! Wera stainless steel tools are manufactured out of stainless steel so unsightly rust can be avoided.

The stainless steel tools from Wera are vacuum ice-hardened and have the hardness and strength needed for screw connections. There are no limitations to the industrial applications they are suitable for.



A precisely-focused laser creates a sharp-edged surface structure. This laser treatment results in an edge hardness of up to 1000 HV 0.3. Wera Lasertip "bites" itself into the screw head and prevents any slips out of the recess. It is available for screwdrivers for slotted, Phillips and Pozidriv screws.



Wera Lasertip reduces the contact pressure required and enhances force transfer – meaning less screwdriving effort is required. Screwdriving becomes safer and easier.



The outstanding design of the Kraftform handle that fits perfectly into the hand prevents hand injuries such as blisters and calluses.



The hard materials used for the handle ensure rapid hand repositioning without any danger of the skin “sticking” to the handle. The surrounding hard zones with large diameters glide like wheels across the hand.



“Take it easy” tool finder: colour coding according to profile and size stamp. This enables faster and more reliable selection of the correct tool from the tool case.



The hexagonal non-roll feature prevents any rolling away at the workplace.

Series Kraftform Screwdrivers

Stainless Steel VDE

3160 i VDE Insulated Screwdriver for slotted screws, stainless



Application: Slotted screws

Blade: Insulated, individually tested as per IEC 60900

Design: Conical edge, Lasertip, stainless steel for minimising rust

Handle: Kraftform with non-roll feature, multi-component. "Take it easy" tool finder: colour coding according to profile (yellow = slotted) and size stamp.

| | mm | mm | mm | mm | " | " |
|---------------------------|-----|-----|-----|----|-------|--------|
| 05022729001 ¹⁾ | 0,5 | 3,0 | 80 | 81 | 1/8" | 3 1/8" |
| 05022730001 | 0,6 | 3,5 | 100 | 81 | 9/64" | 4" |
| 05022731001 | 0,8 | 4,0 | 100 | 98 | 5/32" | 4" |
| 05022732001 | 1,0 | 5,5 | 125 | 98 | 7/32" | 5" |

¹⁾ without Lasertip

3165 i PZ VDE Insulated screwdriver for Pozidriv screws, stainless



Application: Suitable for Pozidriv screws

Blade: Insulated, individually tested as per IEC 60900

Design: Lasertip, stainless steel for minimising rust

Handle: Kraftform with non-roll feature, multi-component. "Take it easy" tool finder: colour coding according to profile (black = Pozidriv) and size stamp.

| | mm | mm | mm | " |
|-------------|------|-----|-----|--------|
| 05022740001 | PZ 1 | 80 | 98 | 3 1/8" |
| 05022741001 | PZ 2 | 100 | 105 | 4" |

3162 i PH VDE Insulated screwdriver for Phillips screws, stainless



Application: Phillips screws

Blade: Insulated, individually tested as per IEC 60900

Design: Lasertip, stainless steel for minimising rust

Handle: Kraftform with non-roll feature, multi-component. "Take it easy" tool finder: colour coding according to profile (red = Phillips) and size stamp.

| | mm | mm | mm | " |
|-------------|------|-----|-----|--------|
| 05022733001 | PH 1 | 80 | 98 | 3 1/8" |
| 05022734001 | PH 2 | 100 | 105 | 4" |

3160 i/7 Screwdriver set, stainless and rack



Kraftform stainless: the safety screwdriver for stainless steel screws, Lasertip blade + voltage tester + rack. "Take it easy" tool finder: colour coding according to profile and size stamp.

Application: Slotted and Phillips screws

Contents: Stainless steel, 7-piece set and rack in display carton

| | |
|-------------|--|
| 05022728001 | |
| + | 3247 1 x 0,5x3,0x70 |
| + | 3162 i VDE 1 x PH 1x80; 1 x PH 2x100 |
| - | 3160 i VDE 1 x 0,5x3,0x80 ¹⁾ ; 1 x 0,6x3,5x100; 1 x 0,8x4,0x100; 1 x 1,0x5,5x125 |

¹⁾ without Lasertip

²⁾ Product not available in the USA and Canada.

3165 i/6 Screwdriver set, stainless and rack



Kraftform stainless: the safety screwdriver for stainless steel screws, Lasertip blade + rack. "Take it easy" tool finder: colour coding according to profile and size stamp.

Application: Slotted and Pozidriv screws

Contents: Stainless steel, 6-piece set and rack in display carton

| | |
|-------------|--|
| 05022745001 | |
| + | 3165 i PZ VDE 1 x PZ 1x80; 1 x PZ 2x100 |
| - | 3160 i VDE 1 x 0,5x3,0x80 ¹⁾ ; 1 x 0,6x3,5x100; 1 x 0,8x4,0x100; 1 x 1,0x5,5x125 |

¹⁾ without Lasertip

Tip



Screwdrivers "Take it easy"

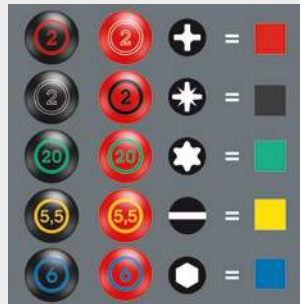

"Take it easy" tool finder: colour coding according to profile and size stamp. This enables faster and more reliable selection of the correct tool from the tool case.



Tested for dielectric strength



Our screwdrivers are tested for dielectric strength under a 10,000 volt load to make sure that their most important property, their insulation, has been exhaustively tested. Each individual Wera VDE screwdriver is subjected to this test to guarantee safe working up to 1,000 volts.

Kraftform Screwdrivers

Series 100 VDE

We want our users to be able to work safely and conveniently.
So we have now transferred the advantages of the Kraftform Plus technology into the VDE segment.



The individual testing at 10,000 volts, in accordance with IEC 60900, ensures safe working with loads up to 1,000 volts.



Impact strength tested at -40°C, guaranteeing safety even under extreme conditions.



The outstanding design of the Kraftform handle ensures that it fits perfectly into the hand, preventing hand injuries such as blisters and calluses.



The hard materials used for the handle ensure rapid hand repositioning, without any danger of the skin "sticking" to the handle. The softer "anti-slip" zones enable the low-loss transfer of high forces – resulting in less screwdriving effort being required.

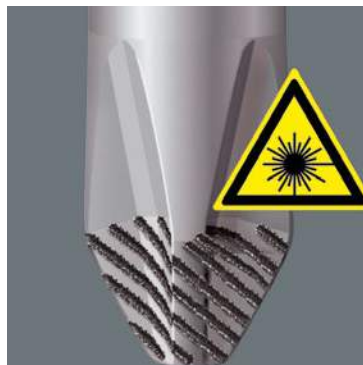

A precisely-focused laser creates a sharp-edged surface structure. This laser treatment results in an edge hardness of up to 1000 HV 0.3. Wera Lasertip "bites" itself into the screw head and prevents any slips out of the recess. It is available for screwdrivers for slotted, Phillips and Pozidriv screws.



"Take it easy" tool finder: colour coding according to profile and size stamp. This enables faster and more reliable selection of the correct tool from the tool case.



The hexagonal non-roll feature prevents any annoying rolling away at the workplace.

Kraftform Plus – Series 100 VDE

The safety screwdriver for working with live wiring

160 i VDE Insulated screwdriver for slotted screws



Application: Slotted screws

Blade: Insulated, individually tested as per IEC 60900

Design: Conical tip, Lasertip

Handle: Kraftform with non-roll feature, multi-component. "Take it easy" tool finder: colour coding according to profile (yellow = slotted) and size stamp.

| | \perp mm | \perp mm | \perp mm | \perp mm | \perp mm | \perp mm |
|---------------------------|---------------|---------------|---------------|---------------|------------------|-------------------|
| 05006100001 ¹⁾ | 0,4 | 2,5 | 80 | 81 | $\frac{3}{32}$ " | $3 \frac{1}{8}$ " |
| 05006105001 ¹⁾ | 0,5 | 3,0 | 100 | 81 | $\frac{1}{8}$ " | 4" |
| 05006110001 | 0,6 | 3,5 | 100 | 81 | $\frac{9}{64}$ " | 4" |
| 05006115001 | 0,8 | 4,0 | 100 | 98 | $\frac{5}{32}$ " | 4" |
| 05006116001 | 0,8 | 4,0 | 150 | 98 | $\frac{5}{32}$ " | 6" |
| 05006120001 | 1,0 | 5,5 | 125 | 98 | $\frac{7}{32}$ " | 5" |
| 05006121001 | 1,0 | 5,5 | 200 | 98 | $\frac{7}{32}$ " | 8" |
| 05006125001 | 1,2 | 6,5 | 150 | 105 | $\frac{1}{4}$ " | 6" |
| 05006126001 | 1,2 | 6,5 | 200 | 105 | $\frac{1}{4}$ " | 8" |
| 05006130001 | 1,2 | 8,0 | 175 | 112 | $\frac{5}{16}$ " | 7" |
| 05006135001 | 1,6 | 8,0 | 200 | 112 | $\frac{5}{16}$ " | 8" |
| 05006140001 | 1,6 | 10,0 | 200 | 112 | $\frac{3}{8}$ " | 8" |

¹⁾ without Lasertip

160 i SB VDE Insulated screwdriver for slotted screws

| | | 4013288 |
|-------------|-------------------------------|---------|
| 05100000001 | 1 x 0.4x2.5x80 ¹⁾ | 181466 |
| 05100001001 | 1 x 0.5x3.0x100 ¹⁾ | 181473 |
| 05100002001 | 1 x 0.6x3.5x100 | 181480 |
| 05100003001 | 1 x 0.8x4.0x100 | 181497 |
| 05100004001 | 1 x 1.0x5.5x125 | 181503 |



160 iS VDE Insulated screwdriver with reduced blade diameter for slotted screws



Application: Slotted screws and actuating tool for spring terminals

Blade: Reduced blade diameter with integrated protective insulation, allows sunken screws and spring elements to be accessed and actuated, individually tested as per IEC 60900

Design: Conical blade, zinc-phosphated

Handle: Kraftform with non-roll feature, multi-component. "Take it easy" tool finder: colour coding according to profile (yellow = slotted) and size stamp.

| | \perp mm | \perp mm | \perp mm | \perp mm | \perp mm | \perp mm |
|-------------|---------------|---------------|---------------|---------------|------------------|---------------|
| 05006440001 | 0,6 | 3,5 | 100 | 81 | $\frac{9}{64}$ " | 4" |
| 05006441001 | 0,8 | 4,0 | 100 | 98 | $\frac{5}{32}$ " | 4" |
| 05006442001 | 1,0 | 5,5 | 125 | 98 | $\frac{7}{32}$ " | 5" |

160 iSS VDE Insulated screwdriver with reduced blade diameter for slotted screws



Application: Slotted screws and actuating tool for spring terminals

Blade: Reduced blade diameter with integrated protective insulation, allows sunken screws and spring elements to be accessed and actuated, individually tested as per IEC 60900

Design: Conical blade, zinc-phosphated

Handle: Kraftform with non-roll feature, multi-component. "Take it easy" tool finder: colour coding according to profile (yellow = slotted) and size stamp.

| | \perp mm | \perp mm | \perp mm | \perp mm | \perp mm | \perp mm |
|-------------|---------------|---------------|---------------|---------------|------------------|---------------|
| 05020129001 | 0,8 | 4,0 | 100 | 81 | $\frac{5}{32}$ " | 4" |

162 i PH VDE Insulated screwdriver for Phillips screws



Application: Phillips screws

Blade: Insulated, individually tested as per IEC 60900

Design: Lasertip

Handle: Kraftform with non-roll feature, multi-component. "Take it easy" tool finder: colour coding according to profile (red = Phillips) and size stamp.

| | + | mm | mm | " |
|---------------------------|------|-----|-----|--------|
| 05006150001 ¹⁾ | PH 0 | 80 | 81 | 3 1/8" |
| 05006152001 | PH 1 | 80 | 98 | 3 1/8" |
| 05006153001 | PH 1 | 150 | 98 | 6" |
| 05006154001 | PH 2 | 100 | 105 | 4" |
| 05006159001 | PH 2 | 200 | 105 | 8" |
| 05006156001 | PH 3 | 150 | 112 | 6" |
| 05006158001 ¹⁾ | PH 4 | 200 | 112 | 8" |

¹⁾ without Lasertip

162 i PH SB VDE Insulated screwdriver for Phillips screws

| | | 4013288 |
|-------------|--------------|---------|
| 05100011001 | 1 x PH 1x80 | 181442 |
| 05100012001 | 1 x PH 2x100 | 181459 |



Tip

VDE-insulated screwdriver with reduced blade diameter

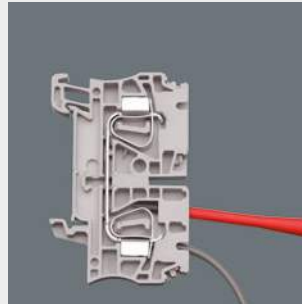

Reduced blade diameter with integrated protective insulation, allows sunken screws and spring elements to be accessed and actuated, individually tested as per IEC 60900.



How to prevent the screwdriver from slipping out of the screw head?



It happens time and time again that the tip slips out of the screw head when screwdriving, sometimes damaging valuable surfaces or even causing injury. The tips of the Wera Lasertip screwdrivers are microscopically roughened by means of a laser. This rough surface literally "bites" itself firmly into the screw head. Slipping out becomes a thing of the past.

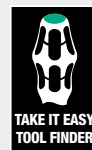

Screwdrivers "Take it easy"



"Take it easy" tool finder: colour coding according to profile and size stamp. This enables faster and more reliable selection of the correct tool from the tool case.

Kraftform Plus – Series 100 VDE

The safety screwdriver for working with live wiring

162 iS PH VDE Insulated screwdriver with reduced blade diameter for Phillips screws



Application: Phillips screws

Blade: Reduced blade diameter with integrated protective insulation, allows sunken PH screws to be accessed and actuated, individually tested as per IEC 60900

Design: Blade zinc-phosphated

Handle: Kraftform with non-roll feature, multi-component. "Take it easy" tool finder: colour coding according to profile (red = Phillips) and size stamp.

| | + | mm | mm | " |
|-------------|------|-----|-----|--------|
| 05006450001 | PH 1 | 80 | 98 | 3 1/8" |
| 05006451001 | PH 2 | 100 | 105 | 4" |

162 iSS PH VDE Insulated screwdriver with reduced blade diameter for Phillips screws



Application: Phillips screws

Blade: Reduced blade diameter with integrated protective insulation, allows sunken PH screws to be accessed and actuated, individually tested as per IEC 60900

Design: Blade zinc-phosphated

Handle: Kraftform with non-roll feature, multi-component. "Take it easy" tool finder: colour coding according to profile (red = Phillips) and size stamp.

| | + | mm | mm | " |
|-------------|------|-----|----|--------|
| 05020131001 | PH 1 | 80 | 81 | 3 1/8" |
| 05020133001 | PH 2 | 100 | 98 | 4" |

165 i PZ VDE Insulated screwdriver for Pozidriv screws



Application: Suitable for Pozidriv screws

Blade: Insulated, individually tested as per IEC 60900

Design: Lasertip

Handle: Kraftform with non-roll feature, multi-component. "Take it easy" tool finder: colour coding according to profile (black = Pozidriv) and size stamp.

| | + | mm | mm | " |
|---------------------------|------|-----|-----|--------|
| 05006160001 ¹⁾ | PZ 0 | 80 | 81 | 3 1/8" |
| 05006162001 | PZ 1 | 80 | 98 | 3 1/8" |
| 05006163001 | PZ 1 | 150 | 98 | 6" |
| 05006164001 | PZ 2 | 100 | 105 | 4" |
| 05006165001 | PZ 2 | 200 | 105 | 8" |
| 05006166001 | PZ 3 | 150 | 112 | 6" |
| 05006168001 ¹⁾ | PZ 4 | 200 | 112 | 8" |

¹⁾ without Lasertip

165 i PZ SB VDE Insulated screwdriver for Pozidriv screws

| | | 4013288 |
|-------------|--------------|---------|
| 05100015001 | 1 x PZ 1x80 | 181510 |
| 05100016001 | 1 x PZ 2x100 | 181527 |



165 iS PZ VDE Insulated screwdriver with reduced blade diameter for Pozidriv screws



Application: Suitable for Pozidriv screws

Blade: Reduced blade diameter with integrated protective insulation, allows sunken PZ screws to be accessed and actuated, individually tested as per IEC 60900

Design: Blade zinc-phosphated

Handle: Kraftform with non-roll feature, multi-component. "Take it easy" tool finder: colour coding according to profile (black = Pozidriv) and size stamp.

| | | mm | mm | in |
|-------------|------|-----|-----|--------|
| 05006460001 | PZ 1 | 80 | 98 | 3 1/8" |
| 05006461001 | PZ 2 | 100 | 105 | 4" |

162 i PH/S VDE Insulated screwdriver for PlusMinus screws (Phillips/slotted)



Application: PlusMinus screws (Phillips/slotted)

Blade: Insulated, individually tested as per IEC 60900

Design: PlusMinus (Phillips/slotted)

Handle: Kraftform with non-roll feature, multi-component

| | | mm | mm | in |
|-------------|-----|-----|-----|--------|
| 05006380001 | # 1 | 80 | 98 | 3 1/8" |
| 05006381001 | # 2 | 100 | 105 | 4" |

162 i PH/S SB VDE Insulated screwdriver for PlusMinus screws (Phillips/slotted)

| | | 4013288 |
|-------------|-------------------------------|---------|
| 05100019001 | 162 i PH/S VDE 1 x # 1x80 | 186560 |
| 05100020001 | 162 i PH/S VDE 1 x # 2x100 | 186577 |



Tip



Screwdrivers "Take it easy"

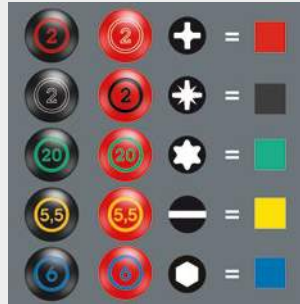

"Take it easy" tool finder: colour coding according to profile and size stamp. This enables faster and more reliable selection of the correct tool from the tool case.



PlusMinus screwdrivers



For the use in terminal blocks, control cabinets, switches, relays, sockets etc.

Non-roll feature



All Kraftform screwdrivers have a non-roll feature at the lower end of the handle. The hexagonal design prevents any annoying rolling away of the screwdriver at the workplace.

Kraftform Plus – Series 100 VDE

The safety screwdriver for working with live wiring

162 iS PH/S VDE Insulated screwdriver with reduced blade diameter for PlusMinus screws (Phillips/slotted)



- Application:** PlusMinus screws (Phillips/slotted)
- Blade:** Reduced blade diameter with integrated protective insulation, allows sunken PlusMinus screws to be accessed and actuated, individually tested as per IEC 60900
- Design:** Combination profile Phillips/slotted, blade zinc-phosphated
- Handle:** Kraftform with non-roll feature, multi-component

| | | mm | mm | |
|-------------|-----|-----|-----|--------|
| 05006455001 | # 1 | 80 | 98 | 3 1/8" |
| 05006456001 | # 2 | 100 | 105 | 4" |

165 iS PZ/S VDE Insulated screwdriver with reduced blade diameter for PlusMinus screws (Pozidriv/slotted)



- Application:** For PlusMinus screws (Pozidriv/slotted)
- Blade:** Reduced blade diameter with integrated protective insulation, allows sunken PlusMinus screws to be accessed and actuated, individually tested as per IEC 60900
- Design:** PlusMinus (Pozidriv/slotted), blade zinc-phosphated
- Handle:** Kraftform with non-roll feature, multi-component

| | | mm | mm | |
|-------------|-----|-----|-----|--------|
| 05006465001 | # 1 | 80 | 98 | 3 1/8" |
| 05006466001 | # 2 | 100 | 105 | 4" |

165 i PZ/S VDE Insulated screwdriver for PlusMinus screws (Pozidriv/slotted)



- Application:** For PlusMinus screws (Pozidriv/slotted)
- Blade:** Insulated, individually tested as per IEC 60900
- Design:** PlusMinus (Pozidriv/slotted)
- Handle:** Kraftform with non-roll feature, multi-component

| | | mm | mm | |
|-------------|-----|-----|-----|--------|
| 05006190001 | # 1 | 80 | 98 | 3 1/8" |
| 05006191001 | # 2 | 100 | 105 | 4" |

165 i PZ/S SB VDE Insulated screwdriver for PlusMinus screws (Pozidriv/slotted)



| | | | |
|-------------|--|-------------------------------|--------|
| 05100021001 | | 165 i PZ/S VDE 1 x # 1x80 | 186584 |
| 05100022001 | | 165 i PZ/S VDE 1 x # 2x100 | 186591 |



165 iSS PZ/S VDE Insulated screwdriver with reduced blade diameter for PlusMinus screws (Pozidriv/slotted)



- Application:** For PlusMinus screws (Pozidriv/slotted)
- Blade:** Reduced blade diameter with integrated protective insulation, allows sunken PlusMinus screws to be accessed and actuated, individually tested as per IEC 60900
- Design:** PlusMinus (Pozidriv/slotted), blade zinc-phosphated
- Handle:** Kraftform with non-roll feature, multi-component

| | | mm | mm | |
|-------------|-----|-----|----|--------|
| 05020132001 | # 1 | 80 | 81 | 3 1/8" |
| 05020134001 | # 2 | 100 | 98 | 4" |

167 i VDE Insulated screwdriver for TORX® screws



Application: TORX® socket screws

Blade: Insulated, individually tested as per IEC 60900

Design: Zinc-phosphated

Handle: Kraffform with non-roll feature, multi-component. "Take it easy" tool finder: colour coding according to profile (green = TORX®) and size stamp.

| | | mm | mm | |
|-------------|-------|-----|-----|--------|
| 05006181001 | TX 5 | 80 | 81 | 3 1/8" |
| 05006182001 | TX 6 | 80 | 81 | 3 1/8" |
| 05006183001 | TX 7 | 80 | 81 | 3 1/8" |
| 05006184001 | TX 8 | 80 | 81 | 3 1/8" |
| 05006169001 | TX 9 | 80 | 81 | 3 1/8" |
| 05006170001 | TX 10 | 80 | 81 | 3 1/8" |
| 05006172001 | TX 15 | 80 | 98 | 3 1/8" |
| 05006174001 | TX 20 | 80 | 98 | 3 1/8" |
| 05006176001 | TX 25 | 100 | 105 | 4" |
| 05006177001 | TX 27 | 100 | 105 | 4" |
| 05006178001 | TX 30 | 100 | 105 | 4" |
| 05006179001 | TX 40 | 150 | 112 | 6" |
| 05006186001 | TX 45 | 150 | 112 | 6" |

164 i VDE Insulated screwdriver for hexagon socket screws



Application: Hexagon socket screws

Blade: Insulated, individually tested as per IEC 60900

Design: Zinc-phosphated

Handle: Kraffform with non-roll feature, multi-component. "Take it easy" tool finder: colour coding according to profile (blue = hexagon) and size stamp.

| | mm | mm | mm | |
|-------------|-----|-----|-----|--------|
| 05004650001 | 2,5 | 80 | 98 | 3 1/8" |
| 05004655001 | 3,0 | 80 | 98 | 3 1/8" |
| 05004660001 | 4,0 | 80 | 98 | 3 1/8" |
| 05004665001 | 5,0 | 80 | 105 | 3 1/8" |
| 05004670001 | 6,0 | 100 | 105 | 4" |
| 05004675001 | 8,0 | 100 | 112 | 4" |

Tip

Tested for dielectric strength



Our screwdrivers are tested for dielectric strength under a 10,000 volt load to make sure that their most important property, their insulation, has been exhaustively tested. Each individual Wera VDE screwdriver is subjected to this test to guarantee safe working up to 1,000 volts.

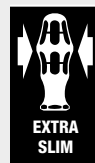

The super slim VDE screwdrivers



The super slim VDE screwdrivers for installation jobs in particularly confined spaces. Not only do the blades have a reduced diameter, the handles also have a very slim design.











Kraftform Plus – Series 100 VDE

The safety screwdriver for working with live wiring





168 i VDE Insulated screwdriver for square socket head screws



- Application:** Square socket head screws
Blade: Insulated, individually tested as per IEC 60900
Design: Zinc-phosphated
Handle: Kraftform with non-roll feature, multi-component

| |  |  |  |  | |
|-------------|--|---|---|---|--------|
| | | mm | mm | " | |
| 05004780001 |  | # 1 | 80 | 98 | 3 1/8" |
| 05004783001 |  | # 1 | 150 | 98 | 6" |
| 05004781001 |  | # 2 | 100 | 105 | 4" |
| 05004784001 |  | # 2 | 200 | 105 | 8" |
| 05004782001 |  | # 3 | 150 | 112 | 6" |

168 i SB VDE Insulated screwdriver for square socket head screws





|  | |  |
|---|---|---|
| | | 4013288 |
| 05100024001 |  1 x # 1x80 | 181534 |
| 05100025001 |  1 x # 2x100 | 181541 |
| 05100026001 |  1 x # 3x150 | 181558 |



190 i VDE Insulated nutdriver



- Application:** Hexagon headed bolts, screws and nuts
Blade: Insulated, individually inspected as per IEC 60900
Design: Zinc-phosphated
Handle: Kraftform with non-roll feature, multi-component







| |  |  |  |  |  | |
|-------------|---|---|---|---|---|----|
| | mm | mm | mm | mm | " | |
| 05005300001 | 5,5 | 125 | 98 | 11,0 | 5" | |
| 05005305001 | 6,0 | 125 | 98 | 12,0 | 5" | |
| 05005310001 | 7,0 | 125 | 105 | 14,0 | 5" | |
| 05005315001 | 8,0 | 125 | 105 | 15,0 | 5" | |
| 05005320001 | 9,0 | 125 | 105 | 16,0 | 5" | |
| 05005325001 | 10,0 | 125 | 112 | 17,0 | 5" | |
| 05005330001 | 11,0 | 125 | 112 | 19,0 | 5" | |
| 05005335001 | 12,0 | 125 | 112 | 20,0 | 5" | |
| 05005340001 | 13,0 | 125 | 112 | 21,0 | 5" | |
| 05104900001 | - | 3/16" | 125 | 98 | 11,0 | 5" |
| 05345280001 | - | 7/32" | 125 | 98 | 12,0 | 5" |
| 05104905001 | - | 1/4" | 125 | 98 | 13,0 | 5" |
| 05104901001 | - | 5/16" | 125 | 105 | 15,0 | 5" |
| 05104906001 | - | 3/8" | 125 | 105 | 17,0 | 5" |
| 05104902001 | - | 7/16" | 125 | 112 | 19,0 | 5" |
| 05104904001 | - | 1/2" | 125 | 112 | 21,0 | 5" |
| 05104903001 | - | 9/16" | 125 | 112 | 23,0 | 5" |
| 05104907001 | - | 5/8" | 125 | 112 | 25,0 | 5" |

247 Single-pole voltage tester









Application: Voltage testing

Standard: ISO 57680/6 and VDE 0680/6 for 150 to 250 V

| |  mm |  mm |  mm |  mm |  mm |  mm |
|-------------|--|--|--|--|--|--|
| 05005655001 | 0,5 | 3,0 | 70 | 3,0 | 1/8" | 2 3/4" |

Product not available in the USA and Canada.

247 SB Single-pole voltage tester

|  |  |  |  |  |  |
|---|---|---|---|---|---|
| 05100100001 | 1 x 0.5x3.0x70 | 4013288 | 181664 | | |

Product not available in the USA and Canada.

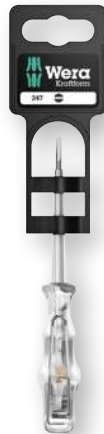

Tip



Why is the Kraftform Plus handle made out of several components?



Wera produces the Kraftform handle out of several materials with different properties. A resistant plastic is used for the core which ensures that the blade is held securely even under high strain. A softer material is used for the coloured soft zones, which provides high frictional resistance and allows the transfer of high

forces – resulting in less required screwdriving effort. The red sections with their hard surfaces prevent any “sticking” of the hand to the handle, making rapid repositioning of the hand possible.



Impact strength



Impact strength tested at -40°C, guaranteeing safety even under extreme conditions.

Kraftform Plus – Series 100 VDE

The safety screwdriver for working with live wiring

Kraftform Big Pack 100 VDE

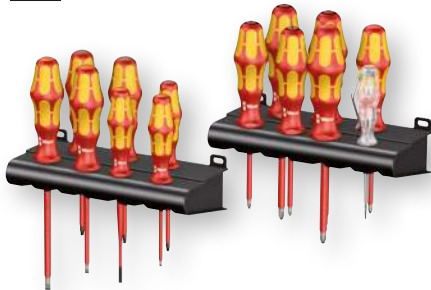

Kraftform: The safety screwdriver with Lasertip blade, voltage tester and rack. "Take it easy" tool finder: colour coding according to profile and size stamp.

Application: Slotted, Phillips, PlusMinus (Pozidriv/slotted), Pozidriv and TORX® screws

Content: 14-piece set in display carton

| | |
|-------------|---|
| 05105631001 | |
| + | 162 i PH VDE 1 x PH 1x80; 1 x PH 2x100 |
| + | 165 i PZ VDE 1 x PZ 1x80; 1 x PZ 2x100 |
| + | 165 i PZ/S VDE 1 x # 1x80; 1 x # 2x100 |
| + | 167 i TORX® VDE 1 x TX 10x80; 1 x TX 15x80; 1 x TX 20x80 |
| ⊖ | 160 iS 1 x 0,6x3,5x100 |
| ⊖ | 160 i VDE 1 x 0,4x2,5x80 ¹⁾ ; 1 x 0,8x4,0x100; 1 x 1,0x5,5x125 |
| ⊖ | 247 1 x 0,5x3,0x70 |
| | Rack 2 x 190,0x50,0 |

¹⁾ without Lasertip

²⁾ Product not available in the USA and Canada.

160 i/6 Rack Screwdriver Set Kraftform Plus Series 100 + Rack



Kraftform: The safety screwdriver. Lasertip blade + rack. "Take it easy" tool finder: colour coding according to profile and size stamp.

Application: For slotted and Phillips screws

Content: 6-pieces set and rack in display carton

| | |
|-------------|--|
| 05006145001 | |
| + | 162 i PH VDE 1 x PH 1x80; 1 x PH 2x100 |
| ⊖ | 160 i VDE 1 x 0,4x2,5x80 ¹⁾ ; 1 x 0,6x3,5x100; 1 x 0,8x4,0x100; 1 x 1,0x5,5x125 |

¹⁾ without Lasertip

160 i/7 Rack screwdriver set Kraftform Plus Series 100, voltage tester and rack



Kraftform: The safety screwdriver with Lasertip blade, voltage tester and rack. "Take it easy" tool finder: colour coding according to profile and size stamp.

Application: Slotted and Phillips screws

Content: 7-piece set and rack in display carton

| | |
|-------------|--|
| 05006147001 | |
| + | 162 i PH VDE 1 x PH 1x80; 1 x PH 2x100 |
| ⊖ | 160 i VDE 1 x 0,4x2,5x80 ¹⁾ ; 1 x 0,6x3,5x100; 1 x 0,8x4,0x100; 1 x 1,0x5,5x125 |
| ⊖ | 247 1 x 0,5x3,0x70 |

¹⁾ without Lasertip

²⁾ Product not available in the USA and Canada.

160 i/165 i/7 Rack screwdriver set Kraffform Plus Series 100, voltage tester and rack

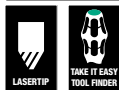

Kraffform: The safety screwdriver with Lasertip blade, voltage tester and rack. "Take it easy" tool finder: colour coding according to profile and size stamp.

Application: Slotted and Pozidriv screws

Content: 7-piece set and rack in display carton

| | | |
|-------------|---------------------|---|
| 05006148001 | | |
| + | 165 i PZ VDE | 1 x PZ 1x80; 1 x PZ 2x100 |
| - | 160 i VDE | 1 x 0,4x2,5x80 ¹⁾ ; 1 x 0,6x3,5x100; 1 x 0,8x4,0x100; 1 x 1,0x5,5x125 |
| - | 247 | 1 x 0,5x3,0x70 |

¹⁾ without Lasertip

²⁾ Product not available in the USA and Canada.

167 i/6 Screwdriver set Kraffform Plus Series 100



Kraffform: The safety screwdriver. "Take it easy" tool finder: colour coding according to profile and size stamp.

Application: TORX® socket screws

Content: 6-piece set

| | | |
|-------------|------------------------|--|
| 05133356001 | | |
| + | 167 i TORX® VDE | 1 x TX 8x80; 1 x TX 9x80; 1 x TX 10x80; 1 x TX 15x80; 1 x TX 20x80; 1 x TX 25x100 |

Tip



Screwdrivers "Take it easy"



"Take it easy" tool finder: colour coding according to profile and size stamp. This enables faster and more reliable selection of the correct tool from the tool case.



Tested for dielectric strength



Our screwdrivers are tested for dielectric strength under a 10,000 volt load to make sure that their most important property, their insulation, has been exhaustively tested. Each individual Wera VDE screwdriver is subjected to this test to guarantee safe working up to 1,000 volts.



Lasertip



A precisely-focused laser creates a sharp-edged surface structure. This laser treatment results in an edge hardness of up to 1000 HV 0.3. Wera Lasertip "bites" itself into the screw head and prevents any slips out of the recess. It is available for screwdrivers for slotted, Phillips and Pozidriv screws.

Kraftform Plus – Series 100 VDE

The safety screwdriver for working with live wiring

160 iS/7 Rack screwdriver set Kraftform Plus Series 100, voltage tester and rack. With reduced blade diameter



Kraftform: The safety screwdriver. With reduced blade diameter, voltage tester and rack. "Take it easy" tool finder: colour coding according to profile and size stamp.

Application: Slotted, Phillips, PlusMinus screws (Pozidriv/slotted)

Content: 7-piece set and rack in display carton

| | | |
|-------------|-------------|---|
| 05006480001 | | |
| + | 162 iS | 1 x PH 1x80; 1 x PH 2x100 |
| + | 165 iS PZ/S | 1 x # 2x100 |
| + | 160 iS | 1 x 0,6x3,5x100; 1 x 0,8x4,0x100; 1 x 1,0x5,5x125 |
| + | 247 | 1 x 0,5x3,0x70 |

^{*)} Product not available in the USA and Canada.

160 iSS/7 screwdriver set Kraftform Plus Series 100. With reduced blade diameter and smaller handle diameters



Kraftform: The safety screwdriver. With reduced blade diameter and partially smaller handle diameters. "Take it easy" tool finder: colour coding according to profile and size stamp.

Application: Slotted, Phillips, PlusMinus screws (Pozidriv/slotted)

Content: 7-piece set

| | | |
|-------------|--------------|----------------------------------|
| 05135961001 | | |
| + | 160 iSS | 1 x 0,8x4,0x100 |
| + | 160 iS | 1 x 0,6x3,5x100; 1 x 1,0x5,5x125 |
| + | 162 iSS | 1 x PH 1x80; 1 x PH 2x100 |
| + | 165 iSS PZ/S | 1 x # 1x80; 1 x # 2x100 |

160 i/168 i/6 Rack screwdriver set Kraftform Plus Series 100 and rack



Kraftform: The safety screwdriver. Lasertip blade + rack. "Take it easy" tool finder: colour coding according to profile and size stamp.

Application: For slotted, Phillips and square socket screws

Content: 6-pieces set and rack in display carton

| | | |
|-------------|--------------|----------------------------------|
| 05347777001 | | |
| + | 162 i PH VDE | 1 x PH 1x80; 1 x PH 2x100 |
| + | 160 i VDE | 1 x 0,6x3,5x100; 1 x 1,0x5,5x125 |
| + | 168 i VDE | 1 x # 1x80; 1 x # 2x100 |

160 i/162 i/167 i/9 Screwdriver set Kraftform Plus Series 100



Kraftform: The safety screwdriver. "Take it easy" tool finder: colour coding according to profile and size stamp.

Application: Slotted, Phillips, Pozidriv, PlusMinus (Pozidriv/slotted) and TORX® socket screws

Content: 9-piece set

| | | |
|-------------|-----------------|--|
| 05133355001 | | |
| + | 162 i PH VDE | 1 x PH 2x100 |
| + | 165 i PZ VDE | 1 x PZ 2x100 |
| + | 165 i PZ/S VDE | 1 x # 1x80; 1 x # 2x100 |
| + | 167 i TORX® VDE | 1 x TX 15x80; 1 x TX 20x80; 1 x TX 25x100 |
| + | 160 i VDE | 1 x 0,4x2,5x80 ¹⁾ ; 1 x 1,0x5,5x125 |

¹⁾ without Lasertip

Kraftform 2go 100

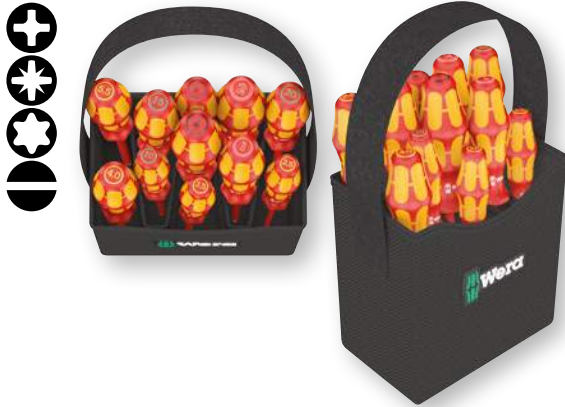

11 VDE-insulated, Kraftform screwdrivers for cross recess screws Phillips and Pozidriv, TORX® and slotted screws. "Take it easy" tool finder: colour coding according to profile and size stamp.

1 dimensionally stable and robust Tool Quiver, equipped with handle for the storage and transport of tools; high resistance against cuts and stabs; comes with hook and loop fastener zone for docking with the Wera 2go system and includes 1 variably adjustable hook and loop fastener partition for a division into as many as 5 sections.

| | |
|-------------|--|
| 05004310001 | |
| | Wera 2go 4 1 x 165,0x165,0x105 |
| + | 162 i PH VDE 1 x PH 1x80; 1 x PH 2x100 |
| + | 165 i PZ VDE 1 x PZ 1x80; 1 x PZ 2x100 |
| ⊕ | 167 i TORX® 1 x TX 10x80; 1 x TX 15x80; 1 x TX 20x80 |
| ⊖ | 160 i VDE 1 x 0,4x2,5x80 ¹⁾ ; 1 x 0,8x4,0x150; 1 x 1,0x5,5x200 |
| ⊖ | 160 iS 1 x 0,6x3,5x100 |
| | Hook and Loop Fastener Strip 120 |

¹⁾ without Lasertip

Tip

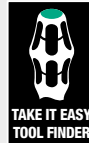

Screwdrivers "Take it easy"

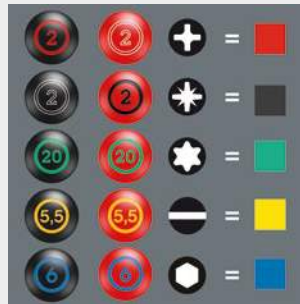

"Take it easy" tool finder: colour coding according to profile and size stamp. This enables faster and more reliable selection of the correct tool from the tool case.

At the workplace and when out and about



The large set-down area improves the stability of the Tool Quiver. Its large handle means that the quiver can be easily transported or simply hung up at the workplace.

High resistance against cuts and stabs



The robust and dimensionally stable material is very resistant against cuts and stabs. The tools carried are protected against damage and moisture. This enhances the service life of the tool box.

Perfect system supplement



Thanks to its hook and loop fastener zone, the Tool Box can be docked with the Wera 2go 1 Tool Carrier and with the Wera 2go 2 Tool Container.



Kraftform Kompakt VDE

Why is the right tool so often missing at the workplace? The reason: too many tools and overly-heavy tool bags can make it bothersome to carry keep them with you.

So for us it was a clear challenge: to develop a tool that is suitable for a whole host of applications and can be easily taken along to the workplace.

Our solution: Kraftform Kompakt tools. A handle into which blades with a range of different profiles can be inserted. Compactly and protectively housed in a light and robust textile pouch – and they are even VDE-tested, too.



Kraftform Kompakt VDE sets come with an insulated handle and insulated interchangeable blades, that can be exchanged without any special tools.



The handle/interchangeable blade system allows rapid exchange of the blades required for a wide range of applications.



Each Kraftform Kompakt VDE set has been tested individually at 10,000 volts, in accordance with IEC 60900. This ten-times-higher testing load guarantees safe working at their maximum permitted load of 1,000 volts.



The tools can be stored and carried in a robust belt pouch, keeping them always to hand.



The hard materials used for the handle ensure rapid hand repositioning, without any danger of the skin “sticking” to the handle. The softer “anti-slip” zones enable the low-loss transfer of high forces – resulting in less screwdriving effort being required.



The outstanding design of the Kraftform handle ensures that it fits perfectly into the hand, preventing hand injuries such as blisters and calluses.

Kraftform Kompakt VDE

Versatile tools for work on live wiring

Kraftform Kompakt VDE 15 Torque 1.2-3.0 Nm extra slim 1



1 Series 7400 VDE Kraftform adjustable torque handle (1.2 - 3.0 Nm) for Wera VDE interchangeable blades only

VDE interchangeable blades (each 154 mm long) with reduced blade diameter (articles KK 60 i 0,4x2,5 and KK 67 i TX 10 conventional diameter) with integrated protective insulation, allows sunken screws and spring elements to be accessed and actuated

15-piece set

| | |
|-------------|--|
| 05059291001 | |
| ● | 7400 VDE 1 x 7441 VDEx1,2-3,0 |
| + | KK 62 iS 1 x PH 1x154; 1 x PH 2x154 |
| + | KK 65 iS PZ 1 x PZ 1x154; 1 x PZ 2x154 |
| + | KK 65 iS PZ/S 1 x # 1x154; 1 x # 2x154 |
| + | KK 67 i TORX® 1 x TX 10x154 |
| + | KK 67 iS 1 x TX 15x154; 1 x TX 20x154; 1 x TX 25x154 TORX® |
| ● | KK 60 i 1 x 0,4x2,5x154 |
| ● | KK 60 iS 1 x 0,6x3,5x154; 1 x 0,8x4,0x154; 1 x 1,0x5,5x154 |

Kraftform Kompakt VDE 16 Torque 1.2-3.0 Nm extra slim 1



1 Series 7400 VDE Kraftform adjustable torque handle (1.2 - 3.0 Nm) and 1 Kraftform handle 817 VDE for Wera VDE interchangeable blades only

VDE interchangeable blades (each 154 mm long) with reduced blade diameter (articles KK 60 i 0,4x2,5 and KK 67 i TX 10 conventional diameter) with integrated protective insulation, allows sunken screws and spring elements to be accessed and actuated

16-piece set

| | |
|-------------|--|
| 05135906001 | |
| ● | 7400 VDE 1 x 7441 VDE, 1,2-3,0 Nm |
| ● | 817 VDE 1 x 9x102 |
| + | KK 62 iS 1 x PH 1x154; 1 x PH 2x154 |
| + | KK 65 iS PZ 1 x PZ 1x154; 1 x PZ 2x154 |
| + | KK 65 iS PZ/S 1 x # 1x154; 1 x # 2x154 |
| + | KK 67 i TORX® 1 x TX 10x154 |
| + | KK 67 iS 1 x TX 15x154; 1 x TX 20x154; 1 x TX 25x154 TORX® |
| ● | KK 60 i 1 x 0,4x2,5x154 |
| ● | KK 60 iS 1 x 0,6x3,5x154; 1 x 0,8x4,0x154; 1 x 1,0x5,5x154 |

Kraftform Kompakt VDE 18 Universal 1



1x Kraftform handle 817 VDE for Wera VDE interchangeable blades only

VDE interchangeable blades (each 154 mm long)

Single-pole voltage tester

18-piece set

| 05003471001 | |
|-------------|---|
| ● | 817 VDE 1 x 9x102 |
| ⊕ | KK 62 i 1 x PH 1x154; 1 x PH 2x154 |
| ⊕ | KK 62 i PH/S 1 x # 1x154; 1 x # 2x154 |
| ⊕ | KK 65 i PZ 1 x PZ 1x154; 1 x PZ 2x154 |
| ⊕ | KK 65 i PZ/S 1 x # 1x154; 1 x # 2x154 |
| ● | KK 60 i 1 x 0,4x2,5x154; 1 x 0,6x3,5x154; 1 x 0,8x4,0x154; 1 x 1,0x5,5x154 |
| ● | KK 96 VK 6,3 1 x 6,3x89 |
| ● | KK 97 VK 8,1 1 x 8,1x89 |
| ⚡ | KK 98 DK 1 x 89 |
| ⚡ | KK 99 FL 1 x 89 |
| ● | 247 1 x 0,5x3,0x70 |

Product not available in the USA and Canada.

Tip



Kraftform VDE adjustable torque handle



Simple setting of the required torque by hand.

Easy-to-read scale value. Measurement accuracy is $\pm 6\%$ in accordance with the standard EN ISO 6789.

Distinctly audible and noticeable excess-load signal when the pre-set torque is reached.

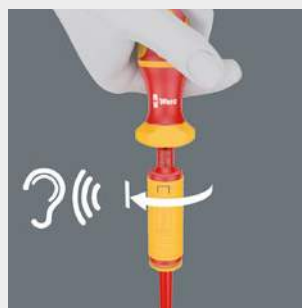
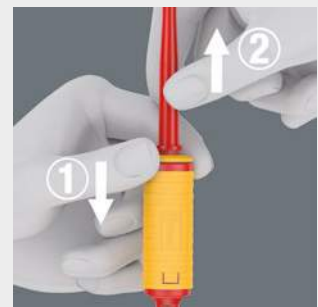
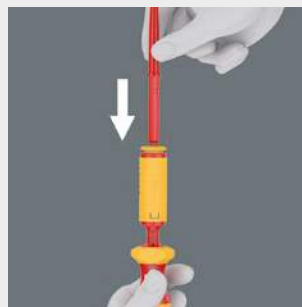

Kraftform Kompakt VDE

Versatile tools for work on live wiring

Kraftform Kompakt VDE 18 Imperial 1



2x Kraftform handle 817 VDE for Wera VDE interchangeable blades only
 VDE interchangeable blades (154 mm long)
 18-piece set

| | |
|-------------|---|
| 05347108001 | |
| ● | 817 VDE 2 x 9x102 |
| ⊕ | KK 62 i 1 x PH 1x154; 1 x PH 2x154 |
| ⊕ | KK 62 i PH/S 1 x # 1x154; 1 x # 2x154 |
| ⊕ | KK 65 i PZ/S 1 x # 1x154; 1 x # 2x154 |
| ● | KK 60 i 1 x 0,4x2,5x154; 1 x 0,6x3,5x154; 1 x 0,8x4,0x154; 1 x 1,0x5,5x154 |
| ○ | KK 68 i 1 x # 1x154; 1 x # 2x154 |
| ○ | KK 96 VK 6,3 1 x 6,3x89 |
| ○ | KK 97 VK 8,1 1 x 8,1x89 |
| △ | KK 98 DK 1 x 89 |
| ◊ | KK 99 FL 1 x 89 |

Kraftform Kompakt VDE 18 Universal 2



2x Kraftform handle 817 VDE for Wera VDE interchangeable blades only
 VDE interchangeable blades (each 154 mm long)
 18-piece set

| | |
|-------------|---|
| 05347107001 | |
| ● | 817 VDE 2 x 9x102 |
| ⊕ | KK 62 i 1 x PH 1x154; 1 x PH 2x154 |
| ⊕ | KK 62 i PH/S 1 x # 1x154; 1 x # 2x154 |
| ● | KK 60 i 1 x 1,0x5,5x154; 1 x 0,4x2,5x154; 1 x 0,6x3,5x154; 1 x 0,8x4,0x154 |
| ⊕ | KK 65 i PZ 1 x PZ 1x154; 1 x PZ 2x154 |
| ⊕ | KK 65 i PZ/S 1 x # 1x154; 1 x # 2x154 |
| ○ | KK 96 VK 6,3 1 x 6,3x89 |
| ○ | KK 97 VK 8,1 1 x 8,1x89 |
| △ | KK 98 DK 1 x 89 |
| ◊ | KK 99 FL 1 x 89 |

Kraftform Kompakt VDE 17 Universal 1



2x 817 VDE Kraftform handle for Wera VDE interchangeable blades only

VDE exchangeable blades (each 154 mm long)

17-piece set

| 05059030001 | | |
|-------------|---------------|--|
| ● | 817 VDE | 2 x 9x102 |
| + | KK 62 i | 1 x PH 1x154; 1 x PH 2x154 |
| + | KK 65 i PZ | 1 x PZ 1x154; 1 x PZ 2x154 |
| + | KK 65 i PZ/S | 1 x # 1x154; 1 x # 2x154 |
| ⊕ | KK 67 i TORX® | 1 x TX 10x154; 1 x TX 15x154; 1 x TX 20x154; 1 x TX 25x154 |
| ⊖ | KK 60 i | 1 x 0,4x2,5x154; 1 x 0,8x4,0x154; 1 x 1,0x5,5x154; 1 x 1,2x6,5x154 |
| ⊖ | KK 60 iS | 1 x 0,6x3,5x154 |

Tip

One handle – many interchangeable blades



The system “one handle – many interchangeable blades” makes Kraftform Kompakt VDE compact screwdriving sets for in-house as well as mobile electrical applications out of the sets. The belt pouch is practical for tidy storage and transportation. Also available with electrical cabinet keys conforming to the industrial standards.



Tested for dielectric strength



Our screwdrivers are tested for dielectric strength under a 10,000 volt load to make sure that their most important property, their insulation, has been exhaustively tested. Each individual Wera VDE screwdriver is subjected to this test to guarantee safe working up to 1,000 volts.

Kraftform Kompakt VDE

Versatile tools for work on live wiring

Kraftform Kompakt VDE 16 Universal 1



1 Kraftform handle 817 VDE for Wera VDE interchangeable blades only

VDE interchangeable blades (each 154 mm long)

Single-pole voltage tester

16-piece set

| | |
|-------------|--|
| | |
| 05003474001 | |
| ● | 817 VDE 1 x 9x102 |
| + | KK 62 i 1 x PH 1x154; 1 x PH 2x154 |
| + | KK 65 i PZ 1 x PZ 1x154; 1 x PZ 2x154 |
| + | KK 65 i PZ/S 1 x # 1x154; 1 x # 2x154 |
| + | KK 67 i TORX® 1 x TX 10x154; 1 x TX 15x154; 1 x TX 20x154; 1 x TX 25x154 |
| ● | KK 60 i 1 x 0,4x2,5x154; 1 x 0,6x3,5x154; 1 x 0,8x4,0x154; 1 x 1,0x5,5x154 |
| ● | 247 1 x 0,5x3,0x70 |

Product not available in the USA and Canada.

Kraftform Kompakt VDE 16 extra slim 1



1 Kraftform handle 817 VDE for Wera VDE interchangeable blades only

VDE interchangeable blades (each 154 mm long) with reduced blade diameter with integrated protective insulation, allows sunken screws and spring elements to be accessed and actuated

Single-pole voltage tester

16-piece set

| | |
|-------------|--|
| | |
| 05003484001 | |
| ● | 817 VDE 1 x 9x102 |
| + | KK 62 iS 1 x PH 1x154; 1 x PH 2x154 |
| + | KK 65 iS PZ 1 x PZ 1x154; 1 x PZ 2x154 |
| + | KK 65 iS PZ/S 1 x # 1x154; 1 x # 2x154 |
| + | KK 67 i TORX® 1 x TX 10x154 |
| + | KK 67 iS TORX® 1 x TX 15x154; 1 x TX 20x154; 1 x TX 25x154 |
| ● | KK 60 i 1 x 0,4x2,5x154 |
| ● | KK 60 iS 1 x 0,6x3,5x154; 1 x 0,8x4,0x154; 1 x 1,0x5,5x154 |
| ● | 247 1 x 0,5x3,0x70 |

Product not available in the USA and Canada.

Kraftform Kompakt VDE 7 Universal 1



1 Kraftform handle 817 VDE for Wera interchangeable blades only
VDE interchangeable blades (each 154 mm long)
7-piece set

| | |
|-------------|---|
| | |
| 05003470001 | |
| ● | 817 VDE 1 x 9x102 |
| + | KK 62 i 1 x PH 1x154; 1 x PH 2x154 |
| ● | KK 60 i 1 x 0,4x2,5x154; 1 x 0,6x3,5x154; 1 x 0,8x4,0x154; 1 x 1,0x5,5x154 |

Kraftform Kompakt VDE 7 Universal 2



1 Kraftform handle 817 VDE for Wera interchangeable blades only
VDE interchangeable blades (each 154 mm long)
7-piece set

| | |
|-------------|---|
| | |
| 05003472001 | |
| ● | 817 VDE 1 x 9x102 |
| + | KK 65 i PZ 1 x PZ 1x154; 1 x PZ 2x154 |
| ● | KK 60 i 1 x 0,4x2,5x154; 1 x 0,6x3,5x154; 1 x 0,8x4,0x154; 1 x 1,0x5,5x154 |

Kraftform Kompakt VDE 7 Imperial 1



1 Kraftform handle 817 VDE for Wera VDE interchangeable blades only
VDE interchangeable blades (each 154 mm long)
7-piece set

| | |
|-------------|--|
| | |
| 05003473001 | |
| ● | 817 VDE 1 x 9x102 |
| + | KK 62 i 1 x PH 1x154; 1 x PH 2x154 |
| ● | KK 60 i 1 x 0,6x3,5x154; 1 x 1,0x5,5x154 |
| □ | KK 68 i 1 x # 1x154; 1 x # 2x154 |



Kraftform Kompakt VDE

Versatile tools for work on live wiring

Series 7400 VDE Kraftform adjustable torque handle (0.3-3.5 Nm)



Application: For Wera interchangeable Kraftform Kompakt VDE blades only

Accuracy: ±6 % (DIN EN ISO 6789). Numerical torque value scale, audible excess-load signal

Handle: Kraftform with non-roll feature, multi-component

| | | mm | Nm | Nm | mm | mm |
|-------------|----------|----|---------|------|-----|----------------------------------|
| 05074752001 | 7440 VDE | 9 | 0,3-1,2 | 0,05 | 192 | 7 ⁹ / ₁₆ " |
| 05074750001 | 7441 VDE | 9 | 1,2-3,0 | 0,10 | 192 | 7 ⁹ / ₁₆ " |
| 05074757001 | 7444 VDE | 9 | 1,7-3,5 | 0,10 | 192 | 7 ⁹ / ₁₆ " |

817 VDE Kraftform blade-holding handle



Application: For Wera interchangeable VDE blades only

Handle: Kraftform with non-roll feature, multi-component

| | mm | mm |
|-------------|----|-----|
| 05003990001 | 9 | 102 |

Kraftform Kompakt VDE 60 i



Application: Slotted screws

Blade: Insulated, individually tested as per IEC 60900

Drive: 9 mm hexagonal with entry chamfer

Design: Conical blade, zinc-phosphated, Black Point

| | mm | mm | mm | mm | mm |
|-------------|-----|-----|-----|--------------------------------|----------------------------------|
| 05003400001 | 0,4 | 2,5 | 154 | ³ / ₃₂ " | 6 ¹ / ₁₆ " |
| 05003401001 | 0,5 | 3,0 | 154 | ¹ / ₈ " | 6 ¹ / ₁₆ " |
| 05003402001 | 0,6 | 3,5 | 154 | ⁹ / ₆₄ " | 6 ¹ / ₁₆ " |
| 05003403001 | 0,8 | 4,0 | 154 | ⁵ / ₃₂ " | 6 ¹ / ₁₆ " |
| 05003404001 | 1,0 | 5,5 | 154 | ⁷ / ₃₂ " | 6 ¹ / ₁₆ " |
| 05003405001 | 1,2 | 6,5 | 154 | ¹ / ₄ " | 6 ¹ / ₁₆ " |

Kraftform Kompakt VDE 60 iS



Application: Slotted screws

Blade: Reduced blade diameter with integrated protective insulation, allows sunken screws and spring elements to be accessed and actuated, individually tested as per IEC 60900

Drive: 9 mm hexagonal with entry chamfer

Design: Conical blade, zinc-phosphated, Black Point

| | mm | mm | mm | mm | mm |
|-------------|-----|-----|-----|--------------------------------|----------------------------------|
| 05003406001 | 0,6 | 3,5 | 154 | ⁹ / ₆₄ " | 6 ¹ / ₁₆ " |
| 05003407001 | 0,8 | 4,0 | 154 | ⁵ / ₃₂ " | 6 ¹ / ₁₆ " |
| 05003408001 | 1,0 | 5,5 | 154 | ⁷ / ₃₂ " | 6 ¹ / ₁₆ " |

Kraftform Kompakt VDE 62 i



Application: Phillips screws

Blade: Insulated, individually tested as per IEC 60900

Drive: 9 mm hexagonal with entry chamfer

Design: Zinc-phosphated, Black Point

| | | mm | mm |
|-------------|------|-----|----------------------------------|
| 05003410001 | PH 0 | 154 | 6 ¹ / ₁₆ " |
| 05003411001 | PH 1 | 154 | 6 ¹ / ₁₆ " |
| 05003412001 | PH 2 | 154 | 6 ¹ / ₁₆ " |

Kraftform Kompakt VDE 62 iS



- Application:** Phillips screws
- Blade:** Reduced blade diameter with integrated protective insulation, allows sunken PH screws to be accessed and actuated, individually tested as per IEC 60900
- Drive:** 9 mm hexagonal with entry chamfer
- Design:** Zinc-phosphated, Black Point

| | | mm | mm |
|-------------|------|-----|---------|
| 05003413001 | PH 1 | 154 | 6 1/16" |
| 05003414001 | PH 2 | 154 | 6 1/16" |

Kraftform Kompakt VDE 65 i



- Application:** Pozidriv screws
- Blade:** Insulated, individually tested as per IEC 60900
- Drive:** 9 mm hexagonal with entry chamfer
- Design:** Zinc-phosphated, Black Point

| | | mm | mm |
|-------------|------|-----|---------|
| 05003450001 | PZ 0 | 154 | 6 1/16" |
| 05003451001 | PZ 1 | 154 | 6 1/16" |
| 05003452001 | PZ 2 | 154 | 6 1/16" |

Kraftform Kompakt VDE 65 iS



- Application:** Pozidriv screws
- Blade:** Reduced blade diameter with integrated protective insulation, allows sunken PZ screws to be accessed and actuated, individually tested as per IEC 60900
- Drive:** 9 mm hexagonal with entry chamfer
- Design:** Zinc-phosphated, Black Point

| | | mm | mm |
|-------------|------|-----|---------|
| 05003455001 | PZ 1 | 154 | 6 1/16" |
| 05003456001 | PZ 2 | 154 | 6 1/16" |

Tip



Kraftform VDE adjustable torque handle



Simple setting of the required torque by hand.

Easy-to-read scale value. Measurement accuracy is $\pm 6\%$ in accordance with the standard EN ISO 6789.

Distinctly audible and noticeable excess-load signal when the pre-set torque is reached.

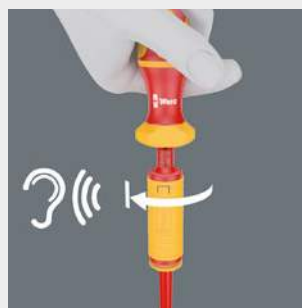
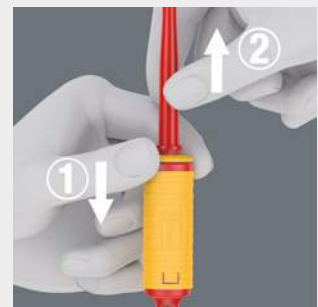
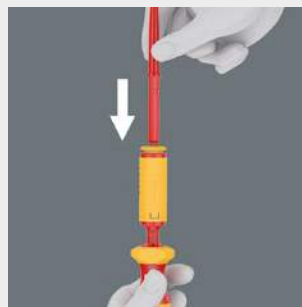



Kraftform Kompakt VDE

Versatile tools for work on live wiring

Kraftform Kompakt VDE 62 i PH/S





- Application:** PlusMinus screws, slotted/Phillips
Blade: Insulated, individually tested as per IEC 60900
Drive: 9 mm hexagonal with entry chamfer
Design: PlusMinus, slotted/Phillips, zinc-phosphated, Black Point

| |  |  mm |  |
|-------------|---|---|---|
| 05003440001 | # 1 | 154 | 6 1/16" " |
| 05003441001 | # 2 | 154 | 6 1/16" " |

Kraftform Kompakt VDE 62 iS PH/S





- Application:** PlusMinus screws, slotted/Phillips
Blade: Reduced blade diameter with integrated protective insulation, allows sunken PlusMinus screws to be accessed and actuated, individually tested as per IEC 60900
Drive: 9 mm hexagonal with entry chamfer
Design: PlusMinus, slotted/Phillips, zinc-phosphated, Black Point

| |  |  mm |  |
|-------------|---|---|---|
| 05003442001 | # 1 | 154 | 6 1/16" " |
| 05003443001 | # 2 | 154 | 6 1/16" " |

Kraftform Kompakt VDE 65 i PZ/S





- Application:** PlusMinus screws, slotted/Pozidriv
Blade: Insulated, individually tested as per IEC 60900
Drive: 9 mm hexagonal with entry chamfer
Design: PlusMinus, slotted/Pozidriv, zinc-phosphated, Black Point

| |  |  mm |  |
|-------------|---|---|---|
| 05003445001 | # 1 | 154 | 6 1/16" " |
| 05003446001 | # 2 | 154 | 6 1/16" " |

Kraftform Kompakt VDE 65 iS PZ/S





- Application:** PlusMinus screws, slotted/Pozidriv
Blade: Reduced blade diameter with integrated protective insulation, allows sunken PlusMinus screws to be accessed and actuated, individually tested as per IEC 60900
Drive: 9 mm hexagonal with entry chamfer
Design: PlusMinus, slotted/Pozidriv, zinc-phosphated, Black Point

| |  |  mm |  |
|-------------|---|---|---|
| 05003447001 | # 1 | 154 | 6 1/16" " |
| 05003448001 | # 2 | 154 | 6 1/16" " |

Kraftform Kompakt VDE 67 i TORX®



- Application:** TORX® socket screws
Blade: Insulated, individually tested as per IEC 60900
Drive: 9 mm hexagonal with entry chamfer
Design: Zinc-phosphated, Black Point

| |  |  mm |  |
|---------------------------|---|---|---|
| 05003429001 ¹⁾ | TX 8 | 154 | 6 1/16" " |
| 05003430001 | TX 9 | 154 | 6 1/16" " |
| 05003431001 | TX 10 | 154 | 6 1/16" " |
| 05003432001 | TX 15 | 154 | 6 1/16" " |
| 05003433001 | TX 20 | 154 | 6 1/16" " |
| 05003434001 | TX 25 | 154 | 6 1/16" " |
| 05003435001 | TX 27 | 154 | 6 1/16" " |
| 05003436001 | TX 30 | 154 | 6 1/16" " |

¹⁾ available from May 2018

Kraftform Kompakt VDE 67 iS TORX®



Application: TORX® socket screws

Blade: Reduced blade diameter with integrated protective insulation, allows sunken TORX® socket screws to be accessed and actuated, individually tested as per IEC 60900

Drive: 9 mm hexagonal with entry chamfer

Design: Zinc-phosphated, Black Point

| 05003437001 | TX 15 | 154 | 6 1/16" |
|-------------|-------|-----|---------|
| 05003438001 | TX 20 | 154 | 6 1/16" |
| 05003439001 | TX 25 | 154 | 6 1/16" |

Kraftform Kompakt VDE 68 i



Application: Square socket head screws

Blade: Insulated, individually tested as per IEC 60900

Drive: 9 mm hexagonal with entry chamfer

Design: Zinc-phosphated, Black Point

| 05003415001 | # 1 | 154 | 6 1/16" |
|-------------|-----|-----|---------|
| 05003416001 | # 2 | 154 | 6 1/16" |

Kraftform Kompakt VDE 68 iS



Application: Square socket head screws

Blade: Reduced blade diameter with integrated protective insulation, allows sunken square socket head screws to be accessed and actuated, individually tested as per IEC 60900

Drive: 9 mm hexagonal with entry chamfer

Design: Zinc-phosphated, Black Point

| 05003417001 | # 1 | 154 | 6 1/16" |
|-------------|-----|-----|---------|
| 05003418001 | # 2 | 154 | 6 1/16" |

Kraftform Kompakt VDE 64 i



Application: Hexagon socket screws

Blade: Insulated, individually tested as per IEC 60900

Drive: 9 mm hexagonal with entry chamfer

Design: Zinc-phosphated, Black Point

| 05003420001 | 2,5 | 154 | 6 1/16" | |
|-------------|-----|-----|---------|--|
| 05003421001 | 3,0 | 154 | 6 1/16" | |
| 05003422001 | 4,0 | 154 | 6 1/16" | |
| 05003423001 | 5,0 | 154 | 6 1/16" | |
| 05003424001 | 6,0 | 154 | 6 1/16" | |





Kraftform Kompakt VDE

Versatile tools for work on live wiring

Kraftform Kompakt 96 VK 6,3





Switch cabinet key, 6.3 mm, glass-fibre reinforced

| |  |  |  |
|-------------|---|---|---|
| | mm | mm | " |
| 05003460001 | 6,3 | 89 | 3 ⁹ / ₁₆ " |

Kraftform Kompakt 99 FL





Switch cabinet key, glass-fibre reinforced

| |  |  |  |
|-------------|---|---|---|
| | | mm | " |
| 05003463001 | | 89 | 3 ⁹ / ₁₆ " |

Kraftform Kompakt 97 VK 8,1





Switch cabinet key, 8.1 mm, glass-fibre reinforced

| |  |  |  |
|-------------|---|---|---|
| | mm | mm | " |
| 05003461001 | 8,1 | 89 | 3 ⁹ / ₁₆ " |

Kraftform Kompakt 98 DK



Switch cabinet key, glass-fibre reinforced

| |  |  |  |
|-------------|---|---|---|
| | | mm | " |
| 05003462001 | | 89 | 3 ⁹ / ₁₆ " |



Kraftform Comfort VDE Screwdrivers

The ergonomic introduction to convenient screwdriving.

Handle with Kraftform geometry and blade made from power bit material with Black Point tip for precise fit – and they are even VDE-tested, too.



Multi-component Kraftform handle, for quick and low-exertion working.

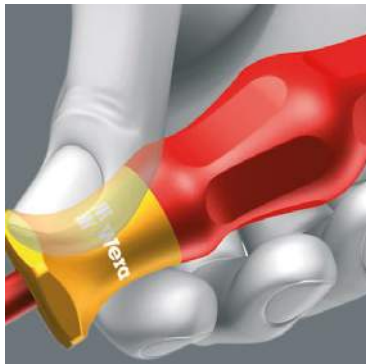

Screw symbol and tip size identification markings on the handle make it easier to find the right screwdriver in the tool case or at the workplace.



Hexagonal non-roll feature prevents any annoying rolling away at the workplace.

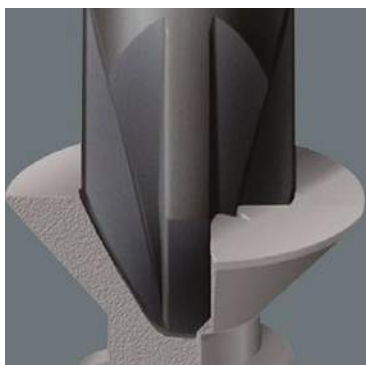

Wera Black Point tips and a refined hardening process ensure long service life of the tip, improved corrosion protection and an exact fit.



The individual testing at 10,000 volts, in accordance with IEC 60900, ensures safe working with loads up to 1,000 volts.

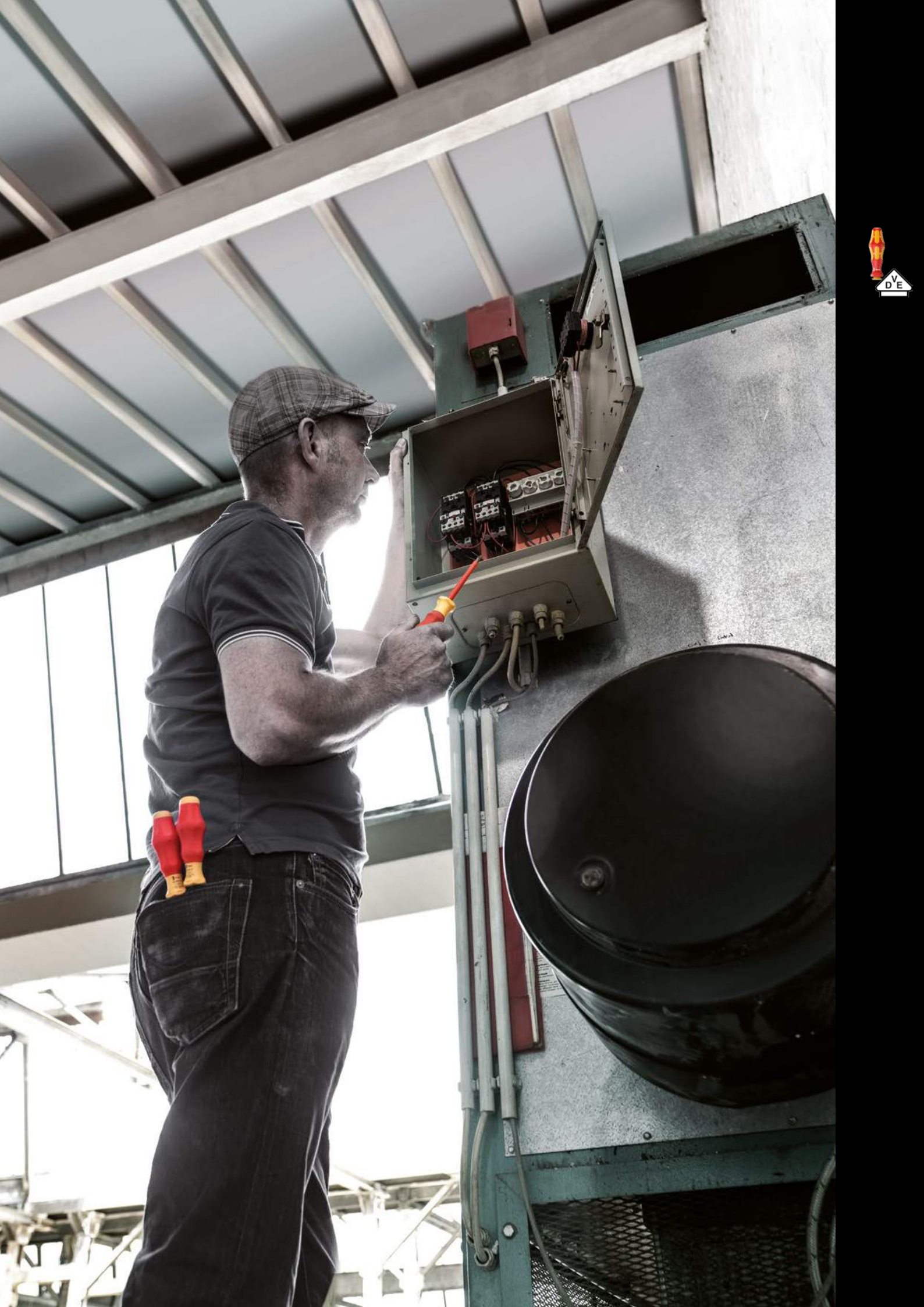

Kraftform Comfort VDE

Convenient, safe, good!

1160 i VDE Insulated screwdriver for slotted screws









Application: Slotted screws

Blade: Insulated, individually tested as per IEC 60900

Design: Conical tip, chrome-plated, Black Point

Handle: Kraftform Comfort with non-roll feature, multi-component

| |  |  |  |  |  |  |
|-------------|---|---|---|---|---|---|
| | mm | mm | mm | mm | " | " |
| 05031580001 | 0,4 | 2,5 | 80 | 81 | 3/32" | 3 1/8" |
| 05031581001 | 0,5 | 3,0 | 100 | 81 | 1/8" | 4" |
| 05031582001 | 0,6 | 3,5 | 100 | 81 | 9/64" | 4" |
| 05031583001 | 0,8 | 4,0 | 100 | 98 | 5/32" | 4" |
| 05031584001 | 0,8 | 4,0 | 150 | 98 | 5/32" | 6" |
| 05031587001 | 1,0 | 5,5 | 125 | 98 | 7/32" | 5" |
| 05031585001 | 1,0 | 5,5 | 200 | 98 | 7/32" | 8" |
| 05031588001 | 1,2 | 6,5 | 150 | 105 | 1/4" | 6" |
| 05031589001 | 1,2 | 8,0 | 175 | 112 | 5/16" | 7" |

1162 i PH VDE Insulated screwdriver for Phillips screws







Application: Phillips screws

Blade: Insulated, individually tested as per IEC 60900

Design: Chrome-plated, Black Point

Handle: Kraftform Comfort with non-roll feature, multi-component

| |  |  |  |  |
|-------------|---|---|---|---|
| | | mm | mm | " |
| 05031600001 | PH 0 | 80 | 81 | 3 1/8" |
| 05031601001 | PH 1 | 80 | 98 | 3 1/8" |
| 05031602001 | PH 1 | 150 | 98 | 6" |
| 05031603001 | PH 2 | 100 | 105 | 4" |
| 05031604001 | PH 2 | 200 | 105 | 8" |
| 05031605001 | PH 3 | 150 | 112 | 6" |

1165 i PZ VDE Insulated screwdriver for Pozidriv screws







Application: Suitable for Pozidriv screws

Blade: Insulated, individually tested as per IEC 60900

Design: Chrome-plated, Black Point

Handle: Kraftform Comfort with non-roll feature, multi-component





| |  |  |  |  |
|-------------|---|---|---|---|
| | | mm | mm | " |
| 05031610001 | PZ 0 | 80 | 81 | 3 1/8" |
| 05031611001 | PZ 1 | 80 | 98 | 3 1/8" |
| 05031613001 | PZ 2 | 100 | 105 | 4" |
| 05031615001 | PZ 3 | 150 | 112 | 6" |

1160 i/7 Safety screwdriver set Kraftform Comfort VDE and voltage tester



Application: Slotted and Phillips screws

Content: 7-piece set in display carton

| | | |
|-------------|---|---|
| 05031575001 |  | |
| |  | 1162 i PH VDE 1 x PH 1x80; 1 x PH 2x100 |
| |  | 1160 i VDE 1 x 0,4x2,5x80; 1 x 0,6x3,5x100; 1 x 0,8x4,0x100; 1 x 1,0x5,5x125 |
| |  | 4115 1 x 0,5x3,0x65 |

Product not available in the USA and Canada.

1160 i/1165 i/7 Screwdriver set Kraftform Comfort VDE and voltage tester



Application: Slotted and Pozidriv screws
Content: 7-piece set in display carton

| | |
|-------------|---|
| 05031576001 | |
| + | 1165 i PZ VDE 1 x PZ 1x80; 1 x PZ 2x100 |
| - | 1160 i VDE 1 x 0,4x2,5x80; 1 x 0,6x3,5x100; 1 x 0,8x4,0x100; 1 x 1,0x5,5x125 |
| - | 4115 1 x 0,5x3,0x65 |

Product not available in the USA and Canada.



Zyklop VDE series

We want users of our tools to work safely and comfortably.

The Zyklop VDE ratchet and matching accessories are the right tools for safe working on electrical systems and impress by their advantages even when used in tight conditions.



The individual testing at 10,000 volts, in accordance with IEC 60900, ensures safe working with loads up to 1,000 volts.



The Zyklop VDE sockets and extensions offer increased safety thanks to their 2-component isolation with yellow insulation core under red insulation outer layer.



The ball lock ensures a secure fit of the sockets and accessories and thus also for increased safety during operation. A short press on the release button and the tool can be changed.



The Zyklop VDE ratchet allows a short return angle of only 4.5° thanks to its 80 teeth.



The extremely slim design of the Zyklop VDE ratchet makes it easy to work even in confined spaces.



The reversing lever ensures a comfortable change of direction.



Zyklop VDE ratchet and accessories

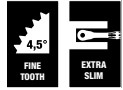

Every piece is safety tested

8007 B VDE Zyklop VDE Ratchet with switch lever and $\frac{3}{8}$ " drive



Application: $\frac{3}{8}$ " square sockets as well as for $\frac{3}{8}$ " adaptors with square drive, with ball locking device

Design: Individually tested as per IEC 60900 at 10,000V for safe working at the approved voltage of 1,000V; slim design to enable work in very confined spaces; fine-tooth mechanism with 80 teeth for a return angle of only 4.5°; switch lever for convenient change of direction; secure socket locking function by push button





| |  | |
|-------------|---|--------------------------|
| |  | $\frac{3}{8}$ " 222,0 |
| 05004966001 | $\frac{3}{8}$ " | 222,0 |

8790 B VDE Zyklop $\frac{3}{8}$ " socket



Application: Hexagon headed bolts, screws and nuts

Design: Insulated, individually tested as per IEC 60900. Increased safety due to 2-component insulation with yellow insulation core, which becomes visible in case of damage to the outer red VDE insulation layer.

| |  |  |  |  |
|-------------|---|---|---|---|
| | mm | mm | mm | mm |
| 05004950001 | 6,0 | 46,0 | 14,8 | 23,0 |
| 05004951001 | 7,0 | 46,0 | 15,7 | 23,0 |
| 05004952001 | 8,0 | 46,0 | 17,0 | 23,0 |
| 05004953001 | 9,0 | 46,0 | 18,2 | 23,0 |
| 05004954001 | 10,0 | 46,0 | 19,4 | 23,0 |
| 05004955001 | 11,0 | 46,0 | 20,7 | 23,0 |
| 05004956001 | 12,0 | 46,0 | 23,0 | 23,0 |
| 05004957001 | 13,0 | 46,0 | 23,0 | 23,0 |
| 05004958001 | 14,0 | 46,0 | 24,7 | 23,0 |
| 05004959001 | 15,0 | 46,0 | 26,0 | 23,0 |
| 05004960001 | 16,0 | 46,0 | 26,8 | 23,0 |
| 05004961001 | 17,0 | 46,0 | 29,0 | 23,0 |
| 05004962001 | 18,0 | 46,0 | 29,6 | 23,0 |
| 05004963001 | 19,0 | 46,0 | 30,7 | 23,0 |



Schütter
Elektro-Service



Zyklop VDE ratchet and accessories

Every piece is safety tested

8794 LB VDE Zyklop extension, long, $\frac{3}{8}$ "



Application: For VDE insulated $\frac{3}{8}$ " square drive sockets with ball lock

Design: Insulated, individually tested as per IEC 60900. Increased safety due to 2-component insulation with yellow insulation core under red isolation outer insulating outer layer

| | | | |
|-------------|---|-----------------|-------|
| |  | $\frac{3}{8}$ " | 166,0 |
| 05004965001 | | | |

8794 SB VDE Zyklop extension, short, $\frac{3}{8}$ "



Application: For VDE insulated $\frac{3}{8}$ " square drive sockets with ball lock

Design: Insulated, individually tested as per IEC 60900. Increased safety due to 2-component insulation with yellow insulation core, which becomes visible in case of damage to the outer red VDE insulation layer.

| | | | |
|-------------|---|-----------------|------|
| |  | $\frac{3}{8}$ " | 91,0 |
| 05004964001 | | | |



8100 SB VDE 1 Zyklop Ratchet Set with switch lever, 3/8" drive, metric



17 pieces; in a surface-preserving, compact and extremely robust textile box; low volume and weight for simplified mobility. Fleece backing and hook and loop fastener system for easy attachment, e. g. on wall, shelf, workshop trolley and the Wera 2go tool transport system. Smooth rotating mechanism for safe storage and easy removal of the Zyklop VDE sockets.

1 Zyklop Ratchet 8007 B VDE, with switch lever, with 3/8" drive, 14 Zyklop VDE sockets, 2 Zyklop VDE extensions, one long, one short, all tools insulated, individually tested as per IEC 60900 at 10,000 V for safe working at the approved voltage of 1,000 V. The Zyklop VDE sockets and extensions offer increased safety through 2-component isolation with yellow insulation core, which becomes visible in case of damage to the outer red VDE insulation layer.

| | |
|---|---|
|  | |
| 05004970001 | |
| ⊙ | 8007 B VDE 1 x 3/8"x222,0 |
| ● | 8790 B VDE 1 x 6,0x46,0; 1 x 7,0x46,0; 1 x 8,0x46,0; 1 x 9,0x46,0; 1 x 10,0x46,0; 1 x 11,0x46,0; 1 x 12,0x46,0; 1 x 13,0x46,0; 1 x 14,0x46,0; 1 x 15,0x46,0; 1 x 16,0x46,0; 1 x 17,0x46,0; 1 x 18,0x46,0; 1 x 19,0x46,0 |
| ⊙ | 8794 SB VDE 1 x 3/8"x91,0 |
| ⊙ | 8794 LB VDE 1 x 3/8"x166,0 |

Tip

Compatible with Wera 2go



The textile box of the ratchet set 8100 SB VDE 1 is suitable for attachment to wall, shelf, workshop trolley and the Wera 2go system thanks to its hook and loop fastener system on the back.



Increased security



The Zyklop VDE sockets and extensions offer increased safety thanks to their 2-component isolation with yellow insulation core under red insulation outer layer.



Ratchets

The Zyklop Ratchets, 1/4"



Zyklop Speed

144



Zyklop Metal Push

152



Zyklop Metal Switch

154



Zyklop Accessories

156

The Zyklop Ratchets, 3/8"



Zyklop Speed

172



Zyklop Metal Push

176



Zyklop Metal Switch

178



Zyklop Accessories

180

The Zyklop Ratchets, 1/2"



Zyklop Speed

190



Zyklop Hybrid

194



Zyklop Metal Push

198



Zyklop Metal Switch

200



Zyklop Accessories

202

1/2" Koloss ratchet with hammer function



210

Zyklop Mini 1 & 2



214



Wera ratchets

We simply could not believe that it was not possible to improve on existing standards for ratchets.

We took up the challenges confronting users when working with ratchets. Mostly, it is a question of working speed, confined working space and diverse functionality.

We did a lot of research, until we finally came up with suitable problem solutions that we can offer across the entire range.



The Zyklop Speed Ratchet

The Wera Zyklop Speed ratchet combines the advantages of five different types of ratchet in one. And it is a really fast mover.

The Zyklop Hybrid Ratchet

Combines robustness, slim design, and little weight.

The Zyklop Ratchet Metal Push

Extremely slim. Long leverage. With push-through square.



The Zyklop Ratchet Metal Switch

Extremely slim. Long leverage. With switch lever.



The Koloss Ratchet

The heavy-duty ratchet that can also be safely used as a hammer.



The Zyklop Mini Ratchets

For all difficult-to-access applications.



Zyklop Speed ratchet

We just could not believe that it was not possible to make a ratchet work more quickly. Moreover, we did not like the way users had to apply many different types of ratchet to get a job done. We therefore questioned everything that was conventional about ratchets. The Zyklop Speed ratchet is what has emerged. The flywheel design of the Zyklop Speed ensures high working speeds. And: the Zyklop Speed combines the advantages of 5 types of ratchet in a single tool. Additionally, it can be used as a screwdriver.



The ratchet head pivots freely and can be locked into any position by using the slide switch that is positioned on either side. It is even possible to work in very confined and difficult-to-access areas with enhanced hand clearance. The pre-defined locking at 0°, 15° and 90°, both to the right and left, ensure safe working without any slipping of the ratchet head.

The Zyklop Speed ratchets are really fast movers. The gyrating mass design means that screwdriving is accelerated. The rotation-symmetric structure of the Kraftform handle and the free-turning sleeve reinforce this rapid twisting process, particularly when the ratchet does not engage due to too little resistance in the thread.



The outstanding design of the Kraftform handle fits perfectly into the hand, preventing hand injuries such as blisters and calluses. The hard materials used for the handle ensure quick and easy hand repositioning without any danger of the skin “sticking” to the handle, whilst the softer “anti-slip” zones enable the low-loss transfer of high forces – resulting in less screwdriving effort being required. The circular handle design allows rapid turning in the 0° position.



All Zyklop Speed ratchets feature a thumbwheel that can be used to quickly and easily switch between clockwise and anticlockwise rotation, at any position. No complicated handling, no loss of time!

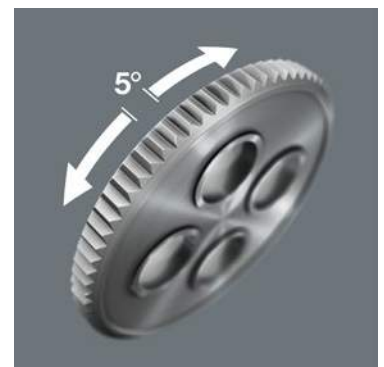

The reversible ratchet with 72 fine-pitched teeth has a low return angle of only 5°. This short stroke allows fast and precise work in all types of installation.



The ball lock holds the sockets and attachments securely, ensuring safe working. A changeover into any predefined position is completed by simply pressing the release button – this is even the case in the 90° position.



The ratchet head has an ergonomic design with finger recesses that offer a perfect contact surface for the hand or fingers to turn the head.



The ratchet can be used as a conventional screwdriver in the 0° position by attaching a bitholding adaptor and a bit.

Zyklop Hybrid ratchet

We wanted to integrate all the mostly-desired ratchet advantages in a single tool. Our idea was to develop a light ratchet with an ergonomic handle, slim design, long lever and an extension option.

Since the term “hybrid” refers to a combination from various sectors, it was quite easy to decide on the name.



The reversible ratchet with 72 finepitched teeth has a low return angle of only 5°. This short stroke allows fast and precise work in all types of installation.



The ball lock holds the sockets and attachments securely, ensuring safe working.



Multi-component Kraftform handle for optimum pressure and tensile loads.



Very slim ratchet head.



Larger overall length for higher torque transfer.



Even more torque can be applied by using the extension.



Zyklop Metal ratchet

Due to the ever-more confined working environment, space is becoming more and more an issue for the application of ratchets. Our product developers therefore intensively occupied themselves with the issue of confined working spaces, and Wera has now solved this problem.

The extremely slim and robust Zyklop Metal ratchet with a long lever was what emerged. When the change in direction needs to be quick, the Zyklop Metal Switch ratchet is the right tool.

When the socket must not get lost and a coincidental change of direction has to be avoided at all cost, the Zyklop Metal Push is the correct choice.



Forged, full metal ratchet (chrome-molybdenum) that is extremely robust with a long service life; slim design to enable work in very confined spaces.



Zyklop Metal Push

Smooth push-through mechanism, that cannot get lost.

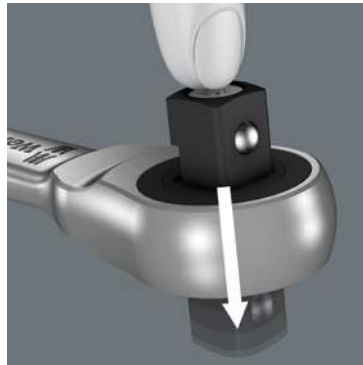

Zyklop Metal Push

The dual-ratchet-teeth design means that a 76 fine-toothing division can be achieved from the 38 robust teeth with a return angle of only 4.7°.

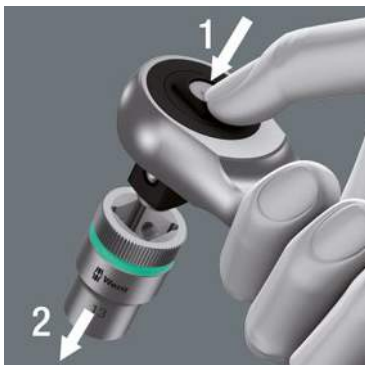

The ball lock holds the sockets and attachments securely, ensuring safe working.



Zyklop Metal Switch
Switch lever for convenient change of direction.



Zyklop Metal Switch
Fine-tooth mechanism with 72 teeth for a return angle of only 5°. This short stroke allows fast and precise work in all types of installation.

Zyklop Accessories

We did not just want our creativity to end with the ratchets themselves so we also occupied ourselves intensively with ratchet accessories. That is why our users are now provided with an extension with freely spinning sleeve and flexible lock to enable more secure and more rapid screwdriving.

The sockets have been completely redesigned: we wanted to spare the user the need of having two different series – one for manual and the other for power tool applications.

And: we wanted to enormous simplify the task of finding the right sizes. Technically, our own ambitious goals represented a real challenge: to endow sockets with the advantage of the holding function on screwdrivers and bits. We succeeded in this!



“Take it easy” tool finder system - with profile and size colour-coding for quick and easy tool selection. Colour-coded system for hexagon drive screws (L-Keys, Zyklop bit sockets), external hex drive screws and nuts (Joker wrenches, Zyklop sockets and Zyklop bit sockets with holding function), and TORX® drive screws (L-Keys, Zyklop bit sockets).



The manual and machine sockets can be used both for hand and power tools use (non-impact). Users need just one socket set for all applications.



Zyklop sockets and bit sockets with holding function securely hold the screw on the tool. This is particularly helpful in difficult-to-access working spaces where the second hand cannot be used to hold the screw.



The extensions from the premium lines are also equipped with the unique “flexible-lock-system”. By activating this system, attachments can be fixed to the extension permanently – preventing slipping and any unintentional loss of the attachment. When the system is deactivated, the sockets can be attached as usual and changed in a flash.



The free-turning sleeve on the Zyklop Speed and the Zyklop extension effectively accelerates the turning of screws and nuts.







Typically Wera designed robust textile belt. A smooth Twist to Unlock mechanism ensures a secure fit and simple removal of the sockets. Includes a snap hook for secure fastening to a belt loop or pocket. Supplied with a non-woven reverse side and hook and loop strips for simple attachment e.g. to a wall, shelf, tool trolley and to the Wera 2go tool transport system.



COOLING COWL CLOSED

FIELD
REPAIRABLE UNIT

Zyklop Ratchets, 1/4"

| | | |
|---|---------------------|------------|
|  | Zyklop Speed | 144 |
|  | Zyklop Metal Push | 152 |
|  | Zyklop Metal Switch | 154 |
|  | Zyklop Accessories | 156 |



The Zyklop Speed Ratchets, 1/4"

Combine 5 types of ratchet

8100 SA All-in Zyklop Speed Ratchet Set, 1/4" drive, with holding function, metric

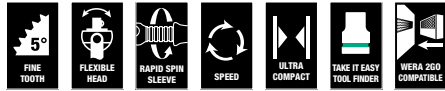

42-piece set; in a surface-preserving, compact and extremely robust textile box; low volume and weight for simplified mobility. Non-woven reverse side and hook and loop strips for simple attachment e.g. to a wall, shelf, tool trolley and to the Wera 2go tool transport system. Fast and easy Twist to Unlock mechanism for secure storage and simple removal of the sockets.

1 Zyklop Speed Ratchet with 1/4" drive, 13 Zyklop sockets with 1/4" drive with fastener holding function, 9 Zyklop bit sockets for TORX® screws, with 1/4" drive, with holding function, 8 bit sockets for hexagon socket screws with 1/4" drive with holding function (sizes 2.0 and 2.5 without holding function) and Hex-Plus high torque geometry, 3 Zyklop bit sockets with 1/4" drive for Phillips screws, 3 Zyklop bit sockets with 1/4" drive for Pozidriv screws, 2 Zyklop bit sockets with 1/4" drive for slotted screws, Take it easy tool finder: Colour coding to enable the desired bit socket to be easily selected, 1 tool for the simple removal of nuts from sockets with holding function, 1 Zyklop extension (long) with free-turning sleeve, 1 wobble extension.

| | |
|-------------|---|
| 05003755001 | |
| ⊙ | 8000 A 1 x 1/4"x152,0 |
| ⊙ | 8796 LA 1 x 1/4"x150,0 |
| ⊙ | 8794 A 1 x 1/4"x56,0 |
| ⊙ | 8790 HMA HF 1 x 4,0x23,0; 1 x 4,5x23,0; 1 x 5,0x23,0; 1 x 5,5x23,0; 1 x 6,0x23,0; 1 x 7,0x23,0; 1 x 8,0x23,0; 1 x 9,0x23,0; 1 x 10,0x23,0; 1 x 11,0x23,0; 1 x 12,0x23,0; 1 x 13,0x23,0; 1 x 14,0x23,0 |
| ⊕ | 8767 A HF 1 x TX 8x28,0; 1 x TX 9x28,0; 1 x TX 10x28,0; 1 x TX 15x28,0; 1 x TX 20x28,0; 1 x TX 25x28,0; 1 x TX 27x28,0; 1 x TX 30x28,0; 1 x TX 40x28,0 |
| ○ | 8740 A 1 x 2,0x28,0; 1 x 2,5x28,0 |
| ○ | 8740 A HF 1 x 3,0x28,0; 1 x 4,0x28,0; 1 x 5,0x28,0; 1 x 6,0x28,0; 1 x 7,0x28,0; 1 x 8,0x28,0 |
| ⊕ | 8751 A 1 x PH 1x28,0; 1 x PH 2x28,0; 1 x PH 3x28,0 |
| ⊕ | 8755 A 1 x PZ 1x28,0; 1 x PZ 2x28,0; 1 x PZ 3x28,0 |
| ⊖ | 8700 A FL 1 x 0,8x5,5x28,0; 1 x 1,2x6,5x28,0 |
| | Nut Extractor 1 x 14,0x43,0 |

8100 SA 6 Zyklop Speed Ratchet Set, 1/4" drive, metric

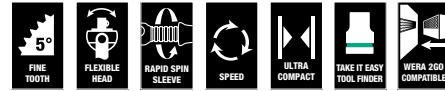

28-piece set; in a surface-preserving, compact and extremely robust textile box; low volume and weight for simplified mobility

1 Zyklop Speed Ratchet with 1/4" drive, 9 Zyklop sockets, 1 Zyklop extension (long) with free-turning sleeve, 1 wobble extension, 1 adaptor with quick-release chuck, 15 bits

| | |
|-------------|---|
| 05004016001 | |
| ⊙ | 8000 A 1 x 1/4"x152,0 |
| ⊙ | 8790 HMA 1 x 5,0x23,0; 1 x 5,5x23,0; 1 x 6,0x23,0; 1 x 7,0x23,0; 1 x 8,0x23,0; 1 x 10,0x23,0; 1 x 11,0x23,0; 1 x 12,0x23,0; 1 x 13,0x23,0 |
| ⊙ | 8794 LA 1 x 1/4"x150,0 |
| ⊙ | 8794 A 1 x 1/4"x56,0 |
| ⊙ | 8784 A1 1 x 1/4"x1/4"x37,0 |
| ⊕ | 851/4 TZ PH 1 x PH 1x50; 1 x PH 2x50; 1 x PH 3x50 |
| ⊕ | 855/4 TZ PZ 1 x PZ 1x50; 1 x PZ 2x50 |
| ⊕ | 867/4 Z TORX® 1 x TX 10x50; 1 x TX 15x50; 1 x TX 20x50; 1 x TX 25x50; 1 x TX 27x50; 1 x TX 30x50 |
| ○ | 840/4 Z Hex-Plus 1 x 3,0x50; 1 x 4,0x50; 1 x 5,0x50; 1 x 6,0x50 |

8100 SA 9 Zyklop Speed Ratchet Set, 1/4" drive, imperial

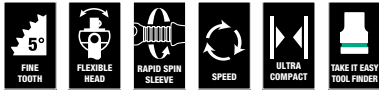

28-piece set; in a surface-preserving, compact and extremely robust textile box; low volume and weight for simplified mobility

1 Zyklop Speed Ratchet with 1/4" drive, 9 Zyklop sockets, 1 Zyklop extension (long) with free-turning sleeve, 1 wobble extension, 1 adaptor with quick-release chuck, 15 bits

| | | |
|-------------|------------------|---|
| 05004019001 | | |
| ⊙ | 8000 A | 1 x 1/4"x152,0 |
| ⊙ | 8790 HMA | 1 x 3/16"x23,0; 1 x 7/32"x23,0; 1 x 1/4"x23,0; 1 x 9/32"x23,0; 1 x 5/16"x23,0; 1 x 11/32"x23,0; 1 x 3/8"x23,0; 1 x 7/16"x23,0; 1 x 1/2"x23,0 |
| ⊙ | 8794 LA | 1 x 1/4"x150,0 |
| ⊙ | 8794 A | 1 x 1/4"x56,0 |
| ⊙ | 8784 A1 | 1 x 1/4"x1/4"x37,0 |
| + | 851/4 TZ PH | 1 x PH 1x50; 1 x PH 2x50; 1 x PH 3x50 |
| + | 855/4 TZ PZ | 1 x PZ 1x50; 1 x PZ 2x50 |
| + | 867/4 Z TORX® | 1 x TX 10x50; 1 x TX 15x50; 1 x TX 20x50; 1 x TX 25x50; 1 x TX 27x50; 1 x TX 30x50 |
| ○ | 840/4 Z Hex-Plus | 1 x 5/32"x50; 1 x 3/16"x50; 1 x 7/32"x50; 1 x 1/4"x50 |

Tip

Zyklop "6 in 1"



1. Fine-tooth ratchet
2. Flex-head ratchet
3. Angle ratchet
4. Quick-release ratchet
5. Power ratchet
6. Screwdriver

New set concept



The textile boxes offer dramatically improved portability, and are space-saving to boot! This means you can now carry the same collection of tools, in a much more compact and comfortable package.



The hassle of running back and forth for the right tools has now become a thing of the past. And the much lower weight of a set makes carrying more convenient than ever before. The textile box including the tool will even survive a fall undamaged.



TAKE IT EASY
TOOL FINDER

"Take it easy"



"Take it easy" tool finder system – with profile and size colour-coding for quick and easy tool selection. Colour-coded system for hexagon drive screws (L-Keys, Zyklop bit sockets), external hex drive screws and nuts (Joker wrenches, Zyklop sockets and Zyklop bit sockets with holding function), and TORX® drive screws (L-Keys, Zyklop bit sockets).

The Zyklop Speed Ratchets, 1/4"

Combine 5 types of ratchet

Kraftform Kompakt Zyklop MS1 Metal/Speed 1/4"

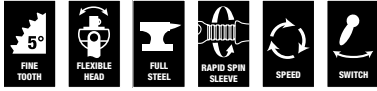

8-piece set; in surface-protecting, compact textile box, highly robust; low volume and weight for simplified mobility.

1 Zyklop Speed ratchet with 1/4" drive, 1 Zyklop Metal ratchet with switch lever and 1/4" drive, 1 Zyklop extension (long) with rapid spin sleeve and "flexible-lock" system, 2 Zyklop extensions (short and long) with rapid spin sleeve, 1 adaptor with rapid change chuck, 1 wobble extension, 1 universal joint.

| | | |
|-------------|---------|--------------------|
| 05135949001 | | |
| ○ | 8000 A | 1 x 1/4"x152,0 |
| ○ | 8004 A | 1 x 1/4"x141,0 |
| ⊗ | 8796 LA | 1 x 1/4"x150,0 |
| ⊗ | 8794 LA | 1 x 1/4"x150,0 |
| ⊗ | 8794 SA | 1 x 1/4"x75,0 |
| ⊗ | 8784 A1 | 1 x 1/4"x1/4"x37,0 |
| ⊗ | 8794 A | 1 x 1/4"x56,0 |
| ⊗ | 8795 A | 1 x 1/4"x35,5 |





The Zyklop Speed Ratchets, 1/4"

Combine 5 types of ratchet

8100 SA 2 Zyklop Speed Ratchet Set, 1/4" drive, metric

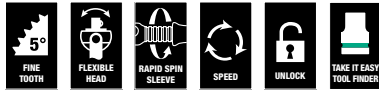

42-piece set in strong metal case

1 Zyklop ratchet with 1/4" drive, 13 Zyklop sockets (metric), 2 Zyklop "flexible-lock" extensions (short and long) with free-turning sleeve, 1 wobble extension, 1 sliding T-handle, 1 universal joint, 1 adaptor with quick-release chuck, 22 bits

| | |
|-------------|--|
| 05003533001 | |
| ⊙ | 8000 A 1 x 1/4"x152,0 |
| ⊙ | 8790 HMA 1 x 4,0x23,0; 1 x 4,5x23,0; 1 x 5,0x23,0; 1 x 5,5x23,0; 1 x 6,0x23,0; 1 x 7,0x23,0; 1 x 8,0x23,0; 1 x 9,0x23,0; 1 x 10,0x23,0; 1 x 11,0x23,0; 1 x 12,0x23,0; 1 x 13,0x23,0; 1 x 14,0x23,0 |
| ⊙ | 8789 A 1 x 1/4"x110,0 |
| ⊙ | 8794 A 1 x 1/4"x56,0 |
| ⊙ | 8795 A 1 x 1/4"x35,5 |
| ⊙ | 8784 A1 1 x 1/4"x1/4"x37,0 |
| ⊙ | 8796 SA 1 x 1/4"x75,0 |
| ⊙ | 8796 LA 1 x 1/4"x150,0 |
| ⊙ | 840/1 Z 1 x 3,0x25; 1 x 4,0x25; 1 x 5,0x25; 1 x 6,0x25; Hex-Plus 1 x 8,0x25 |
| ⊙ | 867/1 Z TORX® 1 x TX 8x25; 1 x TX 9x25; 1 x TX 10x25; B0 1 x TX 15x25; 1 x TX 20x25; 1 x TX 25x25; 1 x TX 30x25; 1 x TX 40x25 |
| ⊙ | 800/1 Z 1 x 0,6x4,5x25; 1 x 1,0x5,5x25; 1 x 1,2x8,0x25 |
| ⊙ | 851/1 Z PH 1 x PH 1x25; 1 x PH 2x25; 1 x PH 3x25 |
| ⊙ | 855/1 Z PZ 1 x PZ 1x25; 1 x PZ 2x25; 1 x PZ 3x25 |

8100 SA 4 Zyklop Speed Ratchet Set, 1/4" drive, imperial

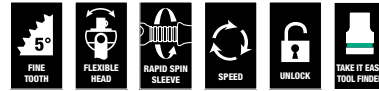

41-piece set in strong metal case

1 Zyklop ratchet with 1/4" drive, 10 Zyklop sockets (imperial), 2 Zyklop "flexible-lock" extensions (short and long) with free-turning sleeve, 1 wobble extension, 1 sliding T-handle, 1 universal joint, 1 adaptor with quick-release chuck, 24 bits

| | |
|-------------|---|
| 05003535001 | |
| ⊙ | 8000 A 1 x 1/4"x152,0 |
| ⊙ | 8790 HMA 1 x 3/16"x23,0; 1 x 7/32"x23,0; 1 x 1/4"x23,0; 1 x 9/32"x23,0; 1 x 5/16"x23,0; 1 x 11/32"x23,0; 1 x 3/8"x23,0; 1 x 7/16"x23,0; 1 x 1/2"x23,0; 1 x 9/16"x23,0 |
| ⊙ | 8789 A 1 x 1/4"x110,0 |
| ⊙ | 8794 A 1 x 1/4"x56,0 |
| ⊙ | 8795 A 1 x 1/4"x35,5 |
| ⊙ | 8784 A1 1 x 1/4"x1/4"x37,0 |
| ⊙ | 8796 SA 1 x 1/4"x75,0 |
| ⊙ | 8796 LA 1 x 1/4"x150,0 |
| ⊙ | 867/1 Z TORX® 1 x TX 8x25; 1 x TX 9x25; 1 x TX 10x25; B0 1 x TX 15x25; 1 x TX 20x25; 1 x TX 25x25; 1 x TX 30x25; 1 x TX 40x25 |
| ⊙ | 800/1 Z 1 x 0,6x4,5x25; 1 x 1,0x5,5x25; 1 x 1,2x8,0x25 |
| ⊙ | 851/1 Z PH 1 x PH 1x25; 1 x PH 2x25; 1 x PH 3x25 |
| ⊙ | 855/1 Z PZ 1 x PZ 1x25; 1 x PZ 2x25; 1 x PZ 3x25 |
| ⊙ | 840/1 Z 1 x 5/64"x25; 1 x 3/32"x25; 1 x 1/8"x25; Hex-Plus 1 x 9/64"x25; 1 x 5/32"x25; 1 x 3/16"x25; 1 x 7/32"x25 |

8100 SA/SC 2 Zyklop Speed Ratchet Set, 1/4" drive and 1/2" drive, metric

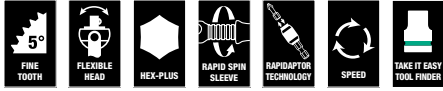

43 piece set, in strong metal case

1 Zyklop ratchet with 1/4" drive, 1 Zyklop ratchet with 1/2" drive, 21 Zyklop sockets (metric), 2 Zyklop "flexible-lock" extensions (long) with freewheel sleeve, 1 adaptor with quick-release chuck, 1 Kraftform bitholding screwdriver with Rapidaptor quick-release chuck, 16 bits

| 05160785001 | | |
|-------------|---------------------|--|
| ● | 8000 A | 1 x 1/4"x152,0 |
| ● | 8790 HMA | 1 x 4,0x23,0; 1 x 4,5x23,0; 1 x 5,0x23,0; 1 x 5,5x23,0; 1 x 6,0x23,0; 1 x 7,0x23,0; 1 x 8,0x23,0; 1 x 9,0x23,0; 1 x 10,0x23,0; 1 x 12,0x23,0; 1 x 13,0x23,0 |
| ● | 8784 A1 | 1 x 1/4"x1/4"x37,0 |
| ● | 8796 LA | 1 x 1/4"x150,0 |
| ● | 8000 C | 1 x 1/2"x277,0 |
| ● | 8790 HMC | 1 x 13,0x37,0; 1 x 14,0x37,0; 1 x 15,0x37,0; 1 x 16,0x37,0; 1 x 17,0x37,0; 1 x 18,0x37,0; 1 x 19,0x37,0; 1 x 21,0x37,0; 1 x 22,0x37,0; 1 x 24,0x37,0 |
| ● | 8796 LC | 1 x 1/2"x250,0 |
| ● | 816 R | 1 x 1/4"x119 |
| ● | 800/4 Z | 1 x 1,0x5,5x89 |
| ● | 840/4 Z Hex-Plus | 1 x 3,0x89; 1 x 4,0x89; 1 x 5,0x89; 1 x 6,0x89 |
| + | 851/4 Z PH | 1 x PH 1x89; 1 x PH 2x89; 1 x PH 3x89 |
| + | 855/4 Z PZ | 1 x PZ 1x89; 1 x PZ 2x89; 1 x PZ 3x89 |
| + | 867/4 Z TORX® BO | 1 x TX 10x89; 1 x TX 15x89; 1 x TX 20x89; 1 x TX 25x89; 1 x TX 30x89 |

Tip

How to notice missing tools more quickly



Perfectly conceived in every detail: the storage case for the Zyklop Speed ratchet sets! The two-tone foam insert section means that the tools can be quickly and reliably replaced, and that missing tools can be detected immediately. The tools and their position can be clearly seen in the lid where they have been laser-etched, ensuring

that they are legible even when the insert section is covered with grease, dirt or oil. Additionally, the foam section can be removed and placed in the drawer of a tool cabinet or trolley.



"Flexible-lock-system"

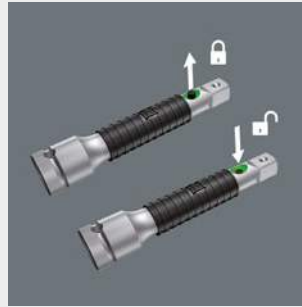

The extensions from the premium lines are also equipped with the unique "flexible-lock-system". By activating this system, attachments can be fixed to the extension permanently – preventing slipping and any unintentional loss of the attachment. When the system is deactivated, the sockets can be attached as usual and changed in a flash.

Is it also possible to reverse the drive with oily hands?



The thumbwheel is designed in such a way that it offers outstanding grip and can, therefore, even be operated with oily fingers.

The Zyklop Speed Ratchets, 1/4"

Combine 5 types of ratchet

Kraftform Kompakt Zyklop Speed

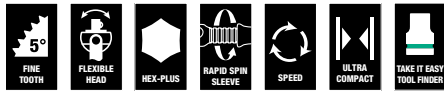

26-piece set in a belt pouch

1 Zyklop Speed ratchet with 1/4" drive, 7 Zyklop sockets (metric), 1 Zyklop extension (long) with free-turning sleeve, 1 adaptor, 16 bits of 50 mm in length

| Icon | Part Number | Description |
|------|------------------|---|
| ⬤ | 05051045001 | |
| ⊙ | 8000 A | 1 x 1/4"x152,0 |
| ⊙ | 8784 A1 | 1 x 1/4"x1/4"x37,0 |
| ⊙ | 8794 LA | 1 x 1/4"x150,0 |
| + | 851/4 TZ PH | 1 x PH 1x50; 1 x PH 2x50; 1 x PH 3x50 |
| + | 855/4 TZ PZ | 1 x PZ 1x50; 1 x PZ 2x50 |
| + | 867/4 Z TORX® | 1 x TX 10x50; 1 x TX 15x50; 1 x TX 20x50; 1 x TX 25x50; 1 x TX 27x50; 1 x TX 30x50 |
| ⊖ | 800/4 Z | 1 x 1,0x5,5x50 |
| ⊖ | 840/4 Z Hex-Plus | 1 x 3,0x50; 1 x 4,0x50; 1 x 5,0x50; 1 x 6,0x50 |
| ⊙ | 8790 HMA | 1 x 5,5x23,0; 1 x 6,0x23,0; 1 x 7,0x23,0; 1 x 8,0x23,0; 1 x 10,0x23,0; 1 x 12,0x23,0; 1 x 13,0x23,0 |



”To learn more about this product, scan the QR code. “

8000 A Zyklop Speed Ratchet with 1/4" drive



Application: 1/4" square sockets and 1/4" adaptors with square drive, equipped with ball lock

Design: Flywheel design and easy-to-grip free-turning sleeve for faster work, swivel ratchet head, defined lock positions at 0° and 90° to the left and right as well as at 15° before 90° inwards, at 0° it can be used like a conventional screwdriver, pushbutton release, left/right switchover, fine-tooth design, small return angle of 5°

Handle: Multi-component Kraftform handle ensures minimum fatigue

| Icon | Part Number | Drive | Length (mm) |
|------|-------------|-------|-------------|
| ⬤ | 05003500001 | 1/4" | 152,0 |

8000 A SB Zyklop Speed Ratchet with 1/4" drive

| Icon | Part Number | Drive | Length (mm) |
|------|-------------|-------|-------------|
| ⬤ | 05073260001 | 1/4" | 152,0 |





The Zyklop Metal Ratchets Push, 1/4"

With push-through square

8100 SA 7 Zyklop Metal Ratchet Set with push-through square, 1/4" drive, metric

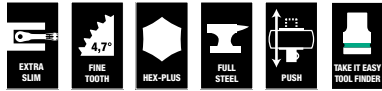

28-piece set; in a surface-preserving, compact and extremely robust textile box; low volume and weight for simplified mobility

1 Zyklop Metal Ratchet with push-through square and 1/4" drive, 9 Zyklop sockets, 1 Zyklop extension (long) with free-turning sleeve, 1 wobble extension, 1 adaptor with quick-release chuck, 15 bits

| | |
|------------------|--|
| 05004017001 | |
| 8003 A | 1 x 1/4"x141,0 |
| 8790 HMA | 1 x 5,0x23,0; 1 x 5,5x23,0; 1 x 6,0x23,0; 1 x 7,0x23,0; 1 x 8,0x23,0; 1 x 10,0x23,0; 1 x 11,0x23,0; 1 x 12,0x23,0; 1 x 13,0x23,0 |
| 8794 LA | 1 x 1/4"x150,0 |
| 8794 A | 1 x 1/4"x56,0 |
| 8784 A1 | 1 x 1/4"x1/4"x37,0 |
| 851/1 Z PH | 1 x PH 1x25; 1 x PH 2x25; 1 x PH 3x25 |
| 855/1 Z PZ | 1 x PZ 1x25; 1 x PZ 2x25 |
| 867/1 Z TORX® | 1 x TX 10x25; 1 x TX 15x25; 1 x TX 20x25; 1 x TX 25x25; 1 x TX 27x25; 1 x TX 30x25 |
| 840/1 Z Hex-Plus | 1 x 3,0x25; 1 x 4,0x25; 1 x 5,0x25; 1 x 6,0x25 |

8100 SA 10 Zyklop Metal Ratchet Set with push-through square, 1/4" drive, imperial



28-piece set; in a surface-preserving, compact and extremely robust textile box; low volume and weight for simplified mobility

1 Zyklop Metal Ratchet with push-through square and 1/4" drive, 9 Zyklop sockets, 1 Zyklop extension (long) with free-turning sleeve, 1 wobble extension, 1 adaptor with quick-release chuck, 15 bits

| | |
|------------------|--|
| 05004020001 | |
| 8003 A | 1 x 1/4"x141,0 |
| 8790 HMA | 1 x 3/16"x23,0; 1 x 7/32"x23,0; 1 x 1/4"x23,0; 1 x 9/32"x23,0; 1 x 5/16"x23,0; 1 x 11/32"x23,0; 1 x 3/8"x23,0; 1 x 7/16"x23,0; 1 x 1/2"x23,0 |
| 8794 LA | 1 x 1/4"x150,0 |
| 8794 A | 1 x 1/4"x56,0 |
| 8784 A1 | 1 x 1/4"x1/4"x37,0 |
| 851/1 Z PH | 1 x PH 1x25; 1 x PH 2x25; 1 x PH 3x25 |
| 855/1 Z PZ | 1 x PZ 1x25; 1 x PZ 2x25 |
| 867/1 Z TORX® | 1 x TX 10x25; 1 x TX 15x25; 1 x TX 20x25; 1 x TX 25x25; 1 x TX 27x25; 1 x TX 30x25 |
| 840/1 Z Hex-Plus | 1 x 5/32"x25; 1 x 3/16"x25; 1 x 7/32"x25; 1 x 1/4"x25 |

8003 A Zyklop Metal Ratchet with push-through square and 1/4" drive

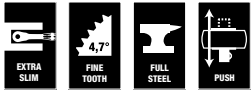

Application: 1/4" square sockets as well as for 1/4" adaptors with square drive, with ball locking device

Design: Forged, full metal ratchet (chrome-molybdenum) that is extremely robust with a long service life; slim design to enable work in very confined spaces; the dual-ratchet-teeth design means that a 76 fine-toothing division can be achieved from the 38 robust teeth with a return angle of only 4.7°; simple direction change with the undetachable push-through square and very secure socket lock mechanism

| | | | | |
|-------------|------|-------|----|----|
| | | | | |
| | mm | mm | mm | |
| 05004003001 | 1/4" | 141,0 | 21 | 22 |



” To learn more about this product, scan the QR code. “

Tip

The Zyklop Metal Ratchets Push



Forged, full metal ratchet (chrome-molybdenum) that is extremely robust with a long service life; slim design to enable work in very confined spaces.

Textile boxes



The textile boxes offer dramatically improved portability, and are space-saving to boot!

This means you can now carry the same collection of tools, in a much more compact and comfortable package. The hassle of running back and forth for the right tools has now become a thing of the past. And the much lower weight of a set makes carrying more convenient than ever before. The textile box including the tool will even survive a fall undamaged. And: it leaves absolutely no signs of scratches on sensitive surfaces.



“Take it easy”



“Take it easy” tool finder system – with profile and size colour-coding for quick and easy tool selection. Colour-coded system for hexagon drive screws (L-Keys, Zyklop bit sockets), external hex drive screws and nuts (Joker wrenches, Zyklop sockets and Zyklop bit sockets with holding function), and TORX® drive screws (L-Keys, Zyklop bit sockets).

The Zyklop Metal Ratchets Switch, 1/4"

With switch lever

8100 SA 8 Zyklop Metal Ratchet Set with switch lever, 1/4" drive, metric

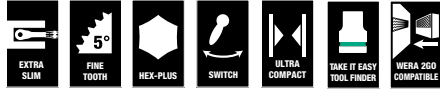

28-piece set; in a surface-preserving, compact and extremely robust textile box; low volume and weight for simplified mobility

1 Zyklop Metal Ratchet with switch lever and 1/4" drive, 9 Zyklop sockets, 1 Zyklop extension (long) with free-turning sleeve, 1 wobble extension, 1 adaptor with quick-release chuck, 15 bits

| | |
|-------------|---|
| 05004018001 | |
| ○ | 8004 A 1 x 1/4"x141,0 |
| ● | 8790 HMA 1 x 5,0x23,0; 1 x 5,5x23,0; 1 x 6,0x23,0; 1 x 7,0x23,0; 1 x 8,0x23,0; 1 x 10,0x23,0; 1 x 11,0x23,0; 1 x 12,0x23,0; 1 x 13,0x23,0 |
| ⊗ | 8794 LA 1 x 1/4"x150,0 |
| ⊗ | 8794 A 1 x 1/4"x56,0 |
| ⊗ | 8784 A1 1 x 1/4"x1/4"x37,0 |
| + | 851/1 Z PH 1 x PH 1x25; 1 x PH 2x25; 1 x PH 3x25 |
| + | 855/1 Z PZ 1 x PZ 1x25; 1 x PZ 2x25 |
| + | 867/1 Z TORX® 1 x TX 10x25; 1 x TX 15x25; 1 x TX 20x25; 1 x TX 25x25; 1 x TX 27x25; 1 x TX 30x25 |
| ○ | 840/1 Z Hex-Plus 1 x 3,0x25; 1 x 4,0x25; 1 x 5,0x25; 1 x 6,0x25 |

8100 SA 11 Zyklop Metal Ratchet Set with switch lever, 1/4" drive, imperial



28-piece set; in a surface-preserving, compact and extremely robust textile box; low volume and weight for simplified mobility

1 Zyklop Metal Ratchet with switch lever and 1/4" drive, 9 Zyklop sockets, 1 Zyklop extension (long) with free-turning sleeve, 1 wobble extension, 1 adaptor with quick-release chuck, 15 bits

| | |
|-------------|---|
| 05004021001 | |
| ○ | 8004 A 1 x 1/4"x141,0 |
| ● | 8790 HMA 1 x 3/16"x23,0; 1 x 7/32"x23,0; 1 x 1/4"x23,0; 1 x 9/32"x23,0; 1 x 5/16"x23,0; 1 x 11/32"x23,0; 1 x 3/8"x23,0; 1 x 7/16"x23,0; 1 x 1/2"x23,0 |
| ⊗ | 8794 LA 1 x 1/4"x150,0 |
| ⊗ | 8794 A 1 x 1/4"x56,0 |
| ⊗ | 8784 A1 1 x 1/4"x1/4"x37,0 |
| + | 851/1 Z PH 1 x PH 1x25; 1 x PH 2x25; 1 x PH 3x25 |
| + | 855/1 Z PZ 1 x PZ 1x25; 1 x PZ 2x25 |
| + | 867/1 Z TORX® 1 x TX 10x25; 1 x TX 15x25; 1 x TX 20x25; 1 x TX 25x25; 1 x TX 27x25; 1 x TX 30x25 |
| ○ | 840/1 Z Hex-Plus 1 x 5/32"x25; 1 x 3/16"x25; 1 x 7/32"x25; 1 x 1/4"x25 |

8100 SA 12 HF Zyklop Metal Ratchet Set with switch lever, 1/4" drive, metric



13-piece set; in a surface-preserving, compact and extremely robust textile box; low volume and weight for simplified mobility

1 Zyklop Metal Ratchet with switch lever and 1/4" drive, 9 Zyklop sockets with 1/4" drive with fastener holding function, 1 Zyklop extension (long) with free-turning sleeve, 1 wobble extension, 1 tool for the simple removal of nuts from sockets with holding function.

| | | |
|-------------|---------------|---|
| 05003756001 | 8004 A | 1 x 1/4"x141,0 |
| | 8794 LA | 1 x 1/4"x150,0 |
| | 8794 A | 1 x 1/4"x56,0 |
| | 8790 HMA HF | 1 x 5,0x23,0; 1 x 5,5x23,0; 1 x 6,0x23,0; 1 x 7,0x23,0; 1 x 8,0x23,0; 1 x 10,0x23,0; 1 x 11,0x23,0; 1 x 12,0x23,0; 1 x 13,0x23,0 |
| | Nut Extractor | 1 x 14,0x43,0 |

8004 A Zyklop Metal Ratchet with switch lever and 1/4" drive



Application: 1/4" square sockets as well as for 1/4" adaptors with square drive, with ball locking device

Design: Forged, full metal ratchet (chrome-molybdenum) that is extremely robust with a long service life; slim design to enable work in very confined spaces; fine-tooth mechanism with 72 teeth for a return angle of only 5°; switch lever for convenient change of direction; secure socket locking function

| | | | | |
|-------------|------|-------|----|----|
| 05004004001 | 1/4" | 141,0 | 19 | 22 |
|-------------|------|-------|----|----|

Tip

The Zyklop Metal Ratchets Switch



Extremely slim. Long leverage. Very robust without any torque limitation. Forged, full metal ratchet out of chrome molybdenum.

Textile boxes



The textile boxes offer dramatically improved portability, and are space-saving to boot!

This means you can now carry the same collection of tools, in a much more compact and comfortable package. The hassle of running back and forth for the right tools has now become a thing of the past. And the much lower weight of a set makes carrying more convenient than ever before. The textile box including the tool will even survive a fall undamaged. And: it leaves absolutely no signs of scratches on sensitive surfaces.



"Take it easy"



"Take it easy" tool finder system – with profile and size colour-coding for quick and easy tool selection. Colour-coded system for hexagon drive screws (L-Keys, Zyklop bit sockets), external hex drive screws and nuts (Joker wrenches, Zyklop sockets and Zyklop bit sockets with holding function), and TORX® drive screws (L-Keys, Zyklop bit sockets).

Zyklop accessories, 1/4"

With amazing product benefits

8790 HMA Zyklop 1/4" socket



Application: Hexagon headed bolts, screws and nuts

Design: Manual and (non-impact) machine applications, ball intercept ring, knurls at base for precision handling in manual operations, chrome vanadium, brushed chrome-plated finish. Take it easy toolfinder: Colour coding and large stamp to enable the desired socket to be easily located.

8790 HMA HF Zyklop socket with 1/4" drive with holding function



Application: Hexagon headed bolts, screws and nuts

Design: Manual and (non-impact) machine applications, ball intercept ring, knurls at base for precision handling in manual operations, with holding function, chrome vanadium, brushed chrome-plated finish. Take it easy toolfinder: Colour coding and large stamp to enable the desired socket to be easily located.

| | mm | mm | mm | mm | mm | mm |
|-------------|------|--------|------|------|------|------|
| 05003501001 | 4,0 | | 23,0 | 6,9 | 13,0 | 10,0 |
| 05003502001 | 4,5 | | 23,0 | 7,5 | 13,0 | 10,0 |
| 05003503001 | 5,0 | | 23,0 | 8,2 | 13,0 | 10,0 |
| 05003504001 | 5,5 | | 23,0 | 8,8 | 13,0 | 10,0 |
| 05003505001 | 6,0 | | 23,0 | 9,4 | 13,0 | 10,0 |
| 05003506001 | 7,0 | | 23,0 | 11,0 | 13,0 | 10,0 |
| 05003507001 | 8,0 | | 23,0 | 12,0 | 13,0 | 10,0 |
| 05003508001 | 9,0 | | 23,0 | 13,0 | 14,0 | 10,0 |
| 05003509001 | 10,0 | | 23,0 | 14,5 | 14,5 | - |
| 05003510001 | 11,0 | | 23,0 | 16,0 | 15,0 | 13,0 |
| 05003511001 | 12,0 | | 23,0 | 17,0 | 16,0 | 13,0 |
| 05003512001 | 13,0 | | 23,0 | 18,0 | 17,0 | 13,0 |
| 05003513001 | 14,0 | | 23,0 | 20,0 | 18,0 | 13,0 |
| 05003514001 | | 3/16" | 23,0 | 7,5 | 13,0 | 10,0 |
| 05003515001 | | 7/32" | 23,0 | 8,8 | 13,0 | 10,0 |
| 05003516001 | | 1/4" | 23,0 | 11,0 | 13,0 | 10,0 |
| 05003517001 | | 9/32" | 23,0 | 11,0 | 13,0 | 10,0 |
| 05003518001 | | 5/16" | 23,0 | 12,0 | 13,0 | 10,0 |
| 05003519001 | | 11/32" | 23,0 | 13,0 | 14,0 | 10,0 |
| 05003520001 | | 3/8" | 23,0 | 14,5 | 14,5 | - |
| 05003521001 | | 7/16" | 23,0 | 16,0 | 15,0 | 13,0 |
| 05003522001 | | 1/2" | 23,0 | 18,0 | 17,0 | 13,0 |
| 05003523001 | | 9/16" | 23,0 | 20,0 | 18,0 | 13,0 |

| | mm | mm | mm | mm | mm |
|-------------|------|------|------|------|------|
| 05003717001 | 4,0 | 23,0 | 7,0 | 11,0 | 6,5 |
| 05003718001 | 4,5 | 23,0 | 7,8 | 11,0 | 6,5 |
| 05003719001 | 5,0 | 23,0 | 8,9 | 11,0 | 6,5 |
| 05003720001 | 5,5 | 23,0 | 9,2 | 11,0 | 6,5 |
| 05003721001 | 6,0 | 23,0 | 10,5 | 11,0 | 6,5 |
| 05003722001 | 7,0 | 23,0 | 11,9 | 11,0 | 6,5 |
| 05003723001 | 8,0 | 23,0 | 12,9 | 11,0 | 6,5 |
| 05003724001 | 9,0 | 23,0 | 14,1 | 12,0 | 6,5 |
| 05003725001 | 10,0 | 23,0 | 15,6 | 12,5 | 10,0 |
| 05003726001 | 11,0 | 23,0 | 17,4 | 13,0 | 10,0 |
| 05003727001 | 12,0 | 23,0 | 18,4 | 14,0 | 10,0 |
| 05003728001 | 13,0 | 23,0 | 19,5 | 15,0 | 10,0 |
| 05003729001 | 14,0 | 23,0 | 20,8 | 16,0 | 10,0 |

**Belt 1 A Zyklop socket set with holding function,
1/4" drive**



10-piece; robust textile socket belt, including snap hook to enable secure fastening to a belt loop or pocket. Non-woven reverse side and hook and loop strips for simple attachment e.g. to a wall, shelf, tool trolley and to the Wera 2go tool transport system. Fast and easy Twist to Unlock mechanism for secure storage and simple removal of the sockets.

9 Zyklop sockets with 1/4" drive with faster holding function. Take it easy tool finder: Colour coding to enable the desired bit socket to be easily selected. 1 tool for the simple removal of nuts from 1/4" sockets with holding function.

| | |
|---------------------------------|--|
| 05003880001 | |
| 8790 HMA HF | 1 x 4,0x23,0; 1 x 4,5x23,0; 1 x 5,0x23,0; 1 x 5,5x23,0; 1 x 6,0x23,0; 1 x 7,0x23,0; 1 x 8,0x23,0; 1 x 10,0x23,0; 1 x 13,0x23,0 |
| Nut Extractor | 1 x 14,0x43,0 |
| Belt A 0/9 | 1 x 39,0x238,0 |
| Hook and Loop Fastener Strip 30 | 1 x 30,0x200,0 |



Tip

How to avoid the need for two socket sets – one for manual and one for machine operations



The manual and machine sockets can be used both for hand and power tools use (non-impact). Users need just one socket set for all applications.

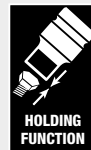

Sockets with retaining function for hexagon headed bolts, screws and nuts



The clamping of the screw is achieved by two flexible locking balls and a robust, permanently elastic, heat-shrunk tubing. The tubing is effectively protected against mechanical wear and tear by a steel ring. The holding function is especially helpful in confined, hard-to-reach spaces, where there is no room for a second hand to secure the screw.



Textile belt



The textile belt can be attached by means of the nonwoven reverse side and the hook and loop strips e.g. to a wall, shelf, tool trolley and to the Wera 2go tool transport system.



Tip

Nut Extractor



Tool made out of synthetic plastic material (TPE) for the simple removal of nuts from sockets with holding function.

| | | |
|-------------|------|------|
| | | |
| | mm | mm |
| 05050005001 | 14,0 | 43,0 |

Nut extractor tool



This tool enables hexagon nuts to be easily removed from sockets with holding function.



Belt A 4 Zyklus socket set, 1/4" drive



9-piece; robust textile socket belt, including snap hook to enable secure fastening to a belt loop or pocket. Non-woven reverse side and hook and loop strips for simple attachment e.g. to a wall, shelf, tool trolley and to the Wera 2go tool transport system. Smooth turning Fast and easy Twist to Unlock mechanism for secure storage and simple removal of the sockets.

9 Zyklus sockets with 1/4" drive. Take it easy tool finder: Colour coding to enable the desired socket to be easily selected.

| | |
|-------------|---|
| | |
| 05003883001 | |
| | 8790 HMA 1 x 5,0x23,0; 1 x 5,5x23,0; 1 x 6,0x23,0; 1 x 7,0x23,0; 1 x 8,0x23,0; 1 x 10,0x23,0; 1 x 11,0x23,0; 1 x 12,0x23,0; 1 x 13,0x23,0 |
| | Belt A 0/9 1 x 39,0x238,0 |
| | Hook and Loop Fastener Strip 30 1 x 30,0x200,0 |

Comes with convenient snap hook



The robust textile belt can be secured to a belt loop or pocket by means of the snap hook.



Secure hold and easy removal



The all new smooth turning mechanism guarantees both secure and rattle-free storage, yet allows easy removal of the tool.

Zyklop accessories, 1/4"



With amazing product benefits

Belt A Imperial 1 Zyklop In-Hex-Plus bit socket set with holding function, 1/4" drive



9-piece; robust textile socket belt, including snap hook to enable secure fastening to a belt loop or pocket. Non-woven reverse side and hook and loop strips for simple attachment e.g. to a wall, shelf, tool trolley and to the Wera 2go tool transport system. Fast and easy Twist to Unlock mechanism for secure storage and simple removal of the sockets.

9 bit sockets for hexagon socket screws with 1/4" drive with holding function (sizes: 5/64", 3/32" and 7/64" without holding function) and Hex-Plus high torque geometry. Take it easy tool finder: Colour coding to enable the desired bit socket to be easily selected.







|  | |
|---|--|
| 05003884001 | |
|  8740 A | 1 x 5/64"x28,0; 1 x 3/32"x28,0; 1 x 7/64"x28,0 |
|  8740 A HF | 1 x 1/8"x28,0; 1 x 9/64"x28,0; 1 x 5/32"x28,0; 1 x 3/16"x28,0; 1 x 7/32"x28,0; 1 x 1/4"x28,0 |
| Belt A 0/8 | 1 x 39,0x220,0 |
| Hook and Loop Fastener Strip 30 | 1 x 30,0x200,0 |

8767 A HF TORX® Zyklop bit socket with holding function, 1/4" drive



Application: TORX® socket screws

Design: Manual and (non-impact) machine applications, ball intercept ring, knurls at base for precision handling in manual operations, bit sockets with all the advantages of the Wera bit technology, brushed chrome-plated finish, holding function for TORX® screws made according to Acument Intellectual Properties specifications. Take it easy tool finder: Colour coding to enable the desired bit socket to be easily located

|  |  |  mm |  mm |  mm |  mm |
|--|---|--|--|--|--|
| 05003360001 | TX 8 | 28,0 | 12,0 | 12,5 | 11,0 |
| 05003361001 | TX 9 | 28,0 | 12,0 | 12,5 | 11,0 |
| 05003362001 | TX 10 | 28,0 | 12,0 | 12,5 | 11,0 |
| 05003363001 | TX 15 | 28,0 | 12,0 | 12,5 | 11,0 |
| 05003364001 | TX 20 | 28,0 | 12,0 | 12,5 | 11,0 |
| 05003365001 | TX 25 | 28,0 | 12,0 | 12,5 | 11,0 |
| 05003366001 | TX 25 | 100,0 | 12,0 | 12,5 | 83,0 |
| 05003367001 | TX 27 | 28,0 | 12,0 | 12,5 | 11,0 |
| 05003368001 | TX 27 | 100,0 | 12,0 | 12,5 | 83,0 |
| 05003369001 | TX 30 | 28,0 | 12,0 | 12,5 | 11,0 |
| 05003370001 | TX 30 | 100,0 | 12,0 | 12,5 | 83,0 |
| 05003371001 | TX 40 | 28,0 | 12,0 | 12,5 | 11,0 |
| 05003372001 | TX 40 | 100,0 | 12,0 | 12,5 | 83,0 |

Belt A 3 TORX® HF Zyklop bit-socket set with holding function, 1/4" drive



9-piece; robust textile socket belt, including snap hook to enable secure fastening to a belt loop or pocket. Non-woven reverse side and hook and loop strips for simple attachment e.g. to a wall, shelf, tool trolley and to the Wera 2go tool transport system. Fast and easy Twist to Unlock mechanism for secure storage and simple removal of the tool sockets.

9 Zyklop bit-sockets for TORX® screws, with 1/4" drive, with holding function. Take it easy tool finder: Colour coding to enable the desired bit-socket to be easily selected.

| | |
|-------------|---|
| 05003882001 | |
| | 8767 A HF 1 x TX 8x28,0; 1 x TX 9x28,0; 1 x TX 10x28,0; 1 x TX 15x28,0; 1 x TX 20x28,0; 1 x TX 25x28,0; 1 x TX 27x28,0; 1 x TX 30x28,0; 1 x TX 40x28,0 |
| | Belt A 0/9 1 x 39,0x238,0 |
| | Hook and Loop Fastener Strip 30 1 x 30,0x200,0 |

8767 A TORX® HF 1 Zyklop bit socket set with holding function, 1/4" drive



4-piece set

Pouch with 100 mm bit sockets

4 Zyklop bit sockets for TORX® screws, with 1/4" drive, with holding function. Take it easy tool finder: Colour coding to enable the desired bit socket to be easily selected.

| | |
|-------------|--|
| 05003375001 | |
| | 8767 A HF 1 x TX 25x100,0; 1 x TX 27x100,0; 1 x TX 30x100,0; 1 x TX 40x100,0 |
| | Hook and Loop Fastener Strip 70 1 x 50,0x70,0 |

Tip



Bit sockets with holding function for TORX® screws



The HF tools developed by Wera are ideal because they feature an optimised geometry of the original TORX® profile. The wedging forces resulting from the surface pressure between the drive tip and the screw profile mean that TORX® screws made according to Acument Intellectual Properties specifications are securely held on the tool!

Extremely short



The bit sockets from Wera are characterized by a particularly short design. Ideal for working in tight spaces.

Wera bit technology



Due to their high-precision profile design and excellent concentricity properties, Wera bit sockets offer safe work and a long product life.

Zyklop accessories, 1/4"

With amazing product benefits

8740 A HF Zyklop bit socket bit socket with holding function, 1/4" drive



Application: Hexagon socket screws

Design: Manual and (non-impact) machine applications, ball intercept ring, knurls at base for precision handling in manual operations, bit sockets with all the advantages of the Wera bit technology, brushed chrome-plated finish, holding function for hexagon socket screws. Take it easy tool finder: Colour coding to enable the desired bit socket to be easily located

| | | mm | mm | mm | mm | mm | mm |
|-------------|--|-----|-------|-------|------|------|------|
| 05003332001 | | 3,0 | | 28,0 | 12,0 | 12,5 | 11,0 |
| 05003333001 | | 4,0 | | 28,0 | 12,0 | 12,5 | 11,0 |
| 05003334001 | | 4,0 | | 100,0 | 12,0 | 12,5 | 83,0 |
| 05003335001 | | 5,0 | | 28,0 | 12,0 | 12,5 | 11,0 |
| 05003336001 | | 5,0 | | 100,0 | 12,0 | 12,5 | 83,0 |
| 05003337001 | | 6,0 | | 28,0 | 12,0 | 12,5 | 11,0 |
| 05003338001 | | 6,0 | | 100,0 | 12,0 | 12,5 | 83,0 |
| 05003341001 | | 7,0 | | 28,0 | 12,0 | 12,5 | 11,0 |
| 05003342001 | | 7,0 | | 100,0 | 12,0 | 12,5 | 83,0 |
| 05003339001 | | 8,0 | | 28,0 | 12,0 | 12,5 | 11,0 |
| 05003340001 | | 8,0 | | 100,0 | 12,0 | 12,5 | 83,0 |
| 05003383001 | | | 1/8" | 28,0 | 12,0 | 12,5 | 11,0 |
| 05003384001 | | | 9/64" | 28,0 | 12,0 | 12,5 | 11,0 |
| 05003385001 | | | 5/32" | 28,0 | 12,0 | 12,5 | 11,0 |
| 05003386001 | | | 3/16" | 28,0 | 12,0 | 12,5 | 11,0 |
| 05003387001 | | | 7/32" | 28,0 | 12,0 | 12,5 | 11,0 |
| 05003388001 | | | 1/4" | 28,0 | 12,0 | 12,5 | 11,0 |
| 05003389001 | | | 5/16" | 28,0 | 12,0 | 12,5 | 11,0 |

8740 A Zyklop bit socket, with 1/4" drive



Application: Hexagon socket screws

Design: Manual and (non-impact) machine applications, ball intercept ring, knurls at base for precision handling in manual operations, bit sockets with all the advantages of the Wera bit technology, brushed chrome-plated finish. Take it easy tool finder: Colour coding to enable the desired bit socket to be easily located

| | | mm | mm | mm | mm | mm | mm |
|-------------|--|-----|-------|------|------|------|------|
| 05003330001 | | 2,0 | | 28,0 | 12,0 | 12,5 | 11,0 |
| 05003331001 | | 2,5 | | 28,0 | 12,0 | 12,5 | 11,0 |
| 05003380001 | | | 5/64" | 28,0 | 12,0 | 12,5 | 11,0 |
| 05003381001 | | | 3/32" | 28,0 | 12,0 | 12,5 | 11,0 |
| 05003382001 | | | 7/64" | 28,0 | 12,0 | 12,5 | 11,0 |

Belt A 2 Zyklop In-Hex-Plus bit-socket set with holding function, 1/4" drive



8-piece; robust textile socket belt, including snap hook to enable secure fastening to a belt loop or pocket. Non-woven reverse side and hook and loop strips for simple attachment e.g. to a wall, shelf, tool trolley and to the Wera 2go tool transport system. Fast and easy Twist to Unlock mechanism for secure storage and simple removal of the sockets.

8 bit-sockets for hexagon socket screws with 1/4" drive with holding function and Hex-Plus high torque geometry. Take it easy tool finder: Colour coding to enable the desired bit-socket to be easily selected.

| 05003881001 | | | |
|-------------|---------------------------------|--|--|
| | 8740 A | 1 x 2,0x28,0; 1 x 2,5x28,0 | |
| | 8740 A HF | 1 x 3,0x28,0; 1 x 4,0x28,0; 1 x 5,0x28,0; 1 x 6,0x28,0; 1 x 7,0x28,0; 1 x 8,0x28,0 | |
| | Belt A 0/8 | 1 x 39,0x220,0 | |
| | Hook and Loop Fastener Strip 30 | 1 x 30,0x200,0 | |

8740 A HF 1 Zyklop bit socket set with holding function, 1/4" drive



5-piece set

Pouch with 100 mm bit sockets

5 Zyklop bit sockets for hexagon socket screws, with 1/4" drive, with holding function, Take it easy tool finder: Colour coding to enable the desired bit socket to be easily located.

| | |
|-------------|--|
| 05003345001 | |
| ○ | 8740 A HF 1 x 4,0x100,0; 1 x 5,0x100,0; 1 x 6,0x100,0; 1 x 7,0x100,0; 1 x 8,0x100,0 |
| | Hook and Loop Fastener Strip 70 1 x 50,0x70,0 |

Socket rail A (textile belt), 8 location, unloaded



1 robust textile belt, unloaded, for up to 8 sockets and/or bit sockets with 1/4" drive. Comes with a snap hook to enable secure fastening to a belt loop or pocket. Nonwoven reverse side and hook and loop strips for simple attachment e.g. to a wall, shelf, tool trolley and to the Wera 2go tool transport system. Fast and easy Twist to Unlock mechanism for secure storage and simple removal of the sockets.

| | |
|-------------|---|
| 05003890001 | |
| | Belt A 0/8 1 x 39,0x220,0 |
| | Hook and Loop Fastener Strip 30 1 x 30,0x200,0 |

Tip



Bit sockets with retaining function for hexagon socket screws



The clamping of the screw is achieved by a flexible locking ball. The holding function is especially helpful in confined, hard-to-reach spaces, where there is no room for a second hand to secure the screw.

Comes with convenient snap hook



The robust textile belt can be secured to a belt loop or pocket by means of the snap hook.



Textile belt



The textile belt can be attached by means of the nonwoven reverse side and the hook and loop strips e.g. to a wall, shelf, tool trolley and to the Wera 2go tool transport system.

Zyklop accessories, 1/4"

With amazing product benefits

Socket rail A (textile belt), 9 location, unloaded



1 robust textile belt, unloaded, for up to 9 sockets and/or bit sockets, with 1/4" drive. Comes with a snap hook to enable secure fastening to a belt loop or pocket. Non-woven reverse side and hook and loop strips for simple attachment e.g. to a wall, shelf, tool trolley and to the Wera 2go tool transport system. Fast and easy Twist to Unlock mechanism for secure storage and simple removal of the sockets.

| | |
|---------------------------------|----------------|
| 05003891001 | |
| Belt A 0/9 | 1 x 39,0x238,0 |
| Hook and Loop Fastener Strip 30 | 1 x 30,0x200,0 |

8751 A Phillips Zyklop bit socket with 1/4" drive



Application: Phillips screws

Design: Manual and (non-impact) machine applications, ball intercept ring, knurls at base for precision handling in manual operations, bit sockets with all the advantages of the Wera bit technology, brushed chrome-plated finish. Output colour coding (red = Phillips) and large stamp to enable the desired bit socket to be easily located.

| | | | mm | mm | mm |
|-------------|------|--|------|------|-----------|
| 05003350001 | PH 1 | | 28,0 | 12,0 | 11,0 12,5 |
| 05003351001 | PH 2 | | 28,0 | 12,0 | 11,0 12,5 |
| 05003352001 | PH 3 | | 28,0 | 12,0 | 11,0 12,5 |

8755 A Pozidriv Zyklop bit socket with 1/4" drive



Application: Suitable for Pozidriv screws

Design: Manual and (non-impact) machine applications, ball intercept ring, knurls at base for precision handling in manual operations, bit sockets with all the advantages of the Wera bit technology, brushed chrome-plated finish. Output colour coding (black = Pozidriv) and large stamp to enable the desired bit socket to be easily located.







| | | | mm | mm | mm |
|-------------|------|--|------|------|-----------|
| 05003353001 | PZ 1 | | 28,0 | 12,0 | 11,0 12,5 |
| 05003354001 | PZ 2 | | 28,0 | 12,0 | 11,0 12,5 |
| 05003355001 | PZ 3 | | 28,0 | 12,0 | 11,0 12,5 |

8700 A FL Slotted screws Zyklop bit socket with 1/4" drive



Application: Slotted screws

Design: Manual and (non-impact) machine applications, ball intercept ring, knurls at base for precision handling in manual operations, bit sockets with all the advantages of the Wera bit technology, brushed chrome-plated finish. Output colour coding (yellow = slotted) and large stamp to enable the desired bit socket to be easily located.

| |  |  |  |  |  |  |
|-------------|---|---|---|---|---|---|
| | | mm | mm | mm | mm | mm |
| 05003320001 | | 0,8 | 5,5 | 28,0 | 12,0 | 11,0 |
| 05003321001 | | 1,0 | 5,5 | 28,0 | 12,0 | 11,0 |
| 05003322001 | | 1,2 | 6,5 | 28,0 | 12,0 | 11,0 |

Tip

Comes with convenient snap hook



The robust textile belt can be secured to a belt loop or pocket by means of the snap hook.



Practical nonwoven strips



The textile belt can be attached by means of the nonwoven reverse side and the hook and loop strips e.g. to a wall, shelf, tool trolley and to the Wera 2go tool transport system.



"Take it easy"

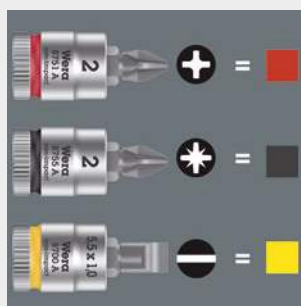

"Take it easy" tool finder system – with profile and size colour-coding for quick and easy tool selection. Colour-coded system for hexagon drive screws (L-Keys, Zyklop bit sockets), external hex drive screws and nuts (Joker wrenches, Zyklop sockets and Zyklop bit sockets with holding function), and TORX® drive screws (L-Keys, Zyklop bit sockets).

Zyklop accessories, 1/4"



With amazing product benefits

8796 SA Zyklop "flexible-lock" extension with free-turning sleeve, short, 1/4"



Application: 1/4" square drive sockets with ball lock

Design: Flexible-lock-system either for permanent interlocking or fast change of accessories, free-turning sleeve for rapid tightening or loosening of screws and nuts, chrome vanadium, brushed chrome-plated finish



| | | |
|---|---|------|
|  |  | mm |
| 05003530001 | 1/4" | 75,0 |

8796 LA Zyklop "flexible-lock" extension with free-turning sleeve, long, 1/4"



Application: 1/4" square drive sockets with ball lock

Design: Flexible-lock-system either for permanent interlocking or fast change of accessories, free-turning sleeve for rapid tightening or loosening of screws and nuts, chrome vanadium, brushed chrome-plated finish



| | | |
|---|---|-------|
|  |  | mm |
| 05003531001 | 1/4" | 150,0 |

8789 A Zyklop sliding T-handle, 1/4"



Application: 1/4" square drive sockets with ball lock

Design: Sliding drive, chrome vanadium, brushed chrome-plated finish



| | | |
|---|---|-------|
|  |  | mm |
| 05003524001 | 1/4" | 110,0 |

8794 LA Zyklop extension with free-turning sleeve, long, 1/4"



Application: 1/4" square drive sockets with ball lock

Design: Easy-to-grip free-turning sleeve for rapid tightening or loosening of screws and nuts, chrome vanadium, brushed chrome-plated finish



| | | |
|---|---|-------|
|  |  | mm |
| 05003526001 | 1/4" | 150,0 |

**8794 SA Zyklop extension
with free-turning sleeve, short, 1/4"**



Application: 1/4" square drive sockets with ball lock

Design: Easy-to-grip free-turning sleeve for rapid tightening or loosening of screws and nuts, chrome vanadium, brushed chrome-plated finish

| | | |
|---|---|------|
|  |   | mm |
| 05003525001 | 1/4" | 75,0 |

Tip



"Flexible-lock-system"

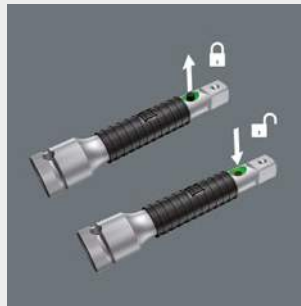

The extensions from the premium lines are also equipped with the unique "flexible-lock-system". By activating this system, attachments can be fixed to the extension permanently – preventing slipping and any unintentional loss of the attachment. When the system is deactivated, the sockets can be attached as usual and changed in a flash.



The free-turning sleeve



The free-turning sleeve effectively speeds up the tightening or loosening of screws and bolts.





8795 A Zyklop universal joint, 1/4"



Application: 1/4" square drive sockets with ball lock

Design: Chrome vanadium/chrome molybdenum, brushed chrome-plated finish



| | | |
|---|---|---|
|  |  |  mm |
| 05003528001 | 1/4" | 35,5 |

8794 A Zyklop wobble extension, 1/4"



Application: 1/4" square drive sockets with ball lock

Design: Swivels through 15°, chrome vanadium, brushed chrome-plated finish





| | | |
|---|---|---|
|  |  |  mm |
| 05003527001 | 1/4" | 56,0 |

8784 A1 Zyklop bit adaptor, 1/4"



Application: Suitable for 1/4" hex bits as per DIN ISO 1173-C 6,3 and E 6,3 and Wera series 1 and 4

Design: Quick-release chuck for fast bit changes, chromium vanadium

| | | | |
|---|---|---|---|
|  |  |  |  mm |
| 05003529001 | 1/4" | 1/4" | 37,0 |

Tip

How to work well in confined installation areas







The Zyklop wobble extensions pivot through 15° in all directions. This enables rapid and precise work in concealed or confined installation areas.





Zyklop Ratchets, 3/8"

| | | |
|---|---------------------|------------|
|  | Zyklop Speed | 172 |
|  | Zyklop Metal Push | 176 |
|  | Zyklop Metal Switch | 178 |
|  | Zyklop Accessories | 180 |



The Zyklop Speed Ratchets, $\frac{3}{8}$ "

5 types of ratchet in 1 tool

8100 SB 6 Zyklop Speed Ratchet Set, $\frac{3}{8}$ " drive, metric

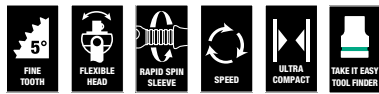

29-piece set; in a surface-preserving, compact and extremely robust textile box; low volume and weight for simplified mobility

1 Zyklop Speed Ratchet with $\frac{3}{8}$ " drive, 9 Zyklop sockets, 1 Zyklop extension (long) with free-turning sleeve, 1 wobble extension, 1 adaptor with quick-release chuck, 16 bits

| | |
|-------------|---|
| 05004046001 | |
| ⊖ | 8000 B 1 x 3/8"x199,0 |
| ⊙ | 8790 HMB 1 x 8,0x29,0; 1 x 10,0x29,0; 1 x 12,0x29,0; 1 x 13,0x29,0; 1 x 15,0x29,0; 1 x 16,0x30,0; 1 x 17,0x30,0; 1 x 18,0x30,0; 1 x 19,0x30,0 |
| ⊕ | 8794 LB 1 x 3/8"x200,0 |
| ⊕ | 8794 B 1 x 3/8"x76,0 |
| ⊕ | 8784 B1 1 x 1/4"x3/8"x44,0 |
| + | 851/4 TZ PH 1 x PH 1x50; 1 x PH 2x50; 1 x PH 3x50 |
| + | 855/4 TZ PZ 1 x PZ 1x50; 1 x PZ 2x50; 1 x PZ 3x50 |
| ⊗ | 867/4 Z TORX® 1 x TX 20x50; 1 x TX 25x50; 1 x TX 27x50; 1 x TX 30x50; 1 x TX 40x50 |
| ○ | 840/4 Z 1 x 4,0x50; 1 x 5,0x50; 1 x 6,0x50; 1 x 8,0x50 |
| ○ | Hex-Plus |
| ● | 800/4 Z 1 x 1,0x5,5x50 |

8100 SB 9 Zyklop Speed Ratchet Set, $\frac{3}{8}$ " drive, imperial

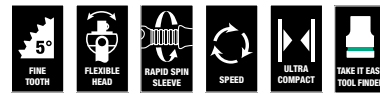

29-piece set; in a surface-preserving, compact and extremely robust textile box; low volume and weight for simplified mobility

1 Zyklop Speed Ratchet with $\frac{3}{8}$ " drive, 9 Zyklop sockets, 1 Zyklop extension (long) with free-turning sleeve, 1 wobble extension, 1 adaptor with quick-release chuck, 16 bits

| | |
|-------------|---|
| 05004049001 | |
| ⊖ | 8000 B 1 x 3/8"x199,0 |
| ⊙ | 8790 HMB 1 x 1/4"x29,0; 1 x 5/16"x29,0; 1 x 3/8"x29,0; 1 x 7/16"x29,0; 1 x 1/2"x29,0; 1 x 9/16"x29,0; 1 x 5/8"x30,0; 1 x 11/16"x30,0; 1 x 3/4"x30,0 |
| ⊕ | 8794 LB 1 x 3/8"x200,0 |
| ⊕ | 8794 B 1 x 3/8"x76,0 |
| ⊕ | 8784 B1 1 x 1/4"x3/8"x44,0 |
| + | 851/4 TZ PH 1 x PH 1x50; 1 x PH 2x50; 1 x PH 3x50 |
| + | 855/4 TZ PZ 1 x PZ 1x50; 1 x PZ 2x50; 1 x PZ 3x50 |
| ⊗ | 867/4 Z TORX® 1 x TX 20x50; 1 x TX 25x50; 1 x TX 27x50; 1 x TX 30x50; 1 x TX 40x50 |
| ○ | 840/4 Z 1 x 3/16"x50; 1 x 7/32"x50; 1 x 1/4"x50; |
| ○ | Hex-Plus 1 x 5/16"x50 |
| ● | 800/4 Z 1 x 1,0x5,5x50 |

8100 SB 2 Zyklop Speed Ratchet Set, 3/8" drive, metric



43-piece set in strong metal case

1 Zyklop ratchet with 3/8" drive, 18 Zyklop sockets (metric), 2 Zyklop "flexible-lock" extensions (short and long) with free-turning sleeve, 1 sliding T-handle, 1 wobble extension, 1 universal joint, 1 adaptor with quick-release chuck, 18 bits

| | | |
|-------------|---------------------|---|
| 05003594001 | | |
| ⊙ | 8000 B | 1 x 3/8"x199,0 |
| ⊙ | 8790 HMB | 1 x 6,0x29,0; 1 x 7,0x29,0; 1 x 8,0x29,0; 1 x 9,0x29,0; 1 x 10,0x29,0; 1 x 11,0x29,0; 1 x 12,0x29,0; 1 x 13,0x29,0; 1 x 14,0x29,0; 1 x 15,0x29,0; 1 x 16,0x30,0; 1 x 17,0x30,0; 1 x 18,0x30,0; 1 x 19,0x30,0; 1 x 20,0x30,0; 1 x 21,0x30,0; 1 x 22,0x30,0; 1 x 24,0x32,0 |
| ⊙ | 8789 B | 1 x 3/8"x165,0 |
| ⊙ | 8794 B | 1 x 3/8"x76,0 |
| ⊙ | 8795 B | 1 x 3/8"x50,0 |
| ⊙ | 8784 B1 | 1 x 1/4"x3/8"x44,0 |
| ⊙ | 8796 SB | 1 x 3/8"x125,0 |
| ⊙ | 8796 LB | 1 x 3/8"x200,0 |
| ⊙ | 840/1 Z Hex-Plus | 1 x 3,0x25; 1 x 4,0x25; 1 x 5,0x25; 1 x 6,0x25; 1 x 8,0x25; 1 x 10,0x25 |
| ⊙ | 867/1 Z TORX® B0 | 1 x TX 10x25; 1 x TX 15x25; 1 x TX 20x25; 1 x TX 25x25; 1 x TX 27x25; 1 x TX 30x25; 1 x TX 40x25 |
| ⊙ | 800/1 Z | 1 x 1,0x5,5x25 |
| ⊙ | 851/1 Z PH | 1 x PH 2x25; 1 x PH 3x25 |
| ⊙ | 855/1 Z PZ | 1 x PZ 2x25; 1 x PZ 3x25 |

Tip

Zyklop "6 in 1"



1. Fine-tooth ratchet
2. Flex-head ratchet
3. Angle ratchet
4. Quick-release ratchet
5. Power ratchet
6. Screwdriver

Textile boxes



The textile boxes offer dramatically improved portability, and are space-saving to boot!

This means you can now carry the same collection of tools, in a much more compact and comfortable package. The hassle of running back and forth for the right tools has now become a thing of the past. And the much lower weight of a set makes carrying more convenient than ever before. The textile box including the tool will even survive a fall undamaged. And: it leaves absolutely no signs of scratches on sensitive surfaces.



The Zyklop VDE ratchet and accessories



The Zyklop VDE ratchet with 3/8" drive and the accessories can be found on pages 124-129.

The Zyklop Speed Ratchets, $\frac{3}{8}$ "

5 types of ratchet in 1 tool

8100 SB 4 Zyklop Speed Ratchet Set, $\frac{3}{8}$ " drive, imperial

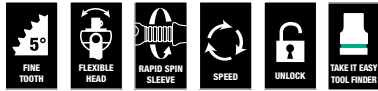

38-piece set in strong metal case

1 Zyklop ratchet with $\frac{3}{8}$ " drive, 12 Zyklop sockets (imperial), 2 Zyklop "flexible-lock" extensions (short and long) with free-turning sleeve, 1 sliding T-handle, 1 wobble extension, 1 universal joint, 1 adaptor with quick-release chuck, 19 bits

| | | |
|-------------|------------------|---|
| 05003596001 | | |
| ● | 8000 B | 1 x $\frac{3}{8}$ "x199,0 |
| ● | 8790 HMB | 1 x $\frac{1}{4}$ "x29,0; 1 x $\frac{5}{16}$ "x29,0; 1 x $\frac{11}{32}$ "x29,0; 1 x $\frac{3}{8}$ "x29,0; 1 x $\frac{7}{16}$ "x29,0; 1 x $\frac{1}{2}$ "x29,0; 1 x $\frac{9}{16}$ "x29,0; 1 x $\frac{5}{8}$ "x30,0; 1 x $\frac{11}{16}$ "x30,0; 1 x $\frac{3}{4}$ "x30,0; 1 x $\frac{13}{16}$ "x30,0; 1 x $\frac{7}{8}$ "x30,0 |
| ○ | 8789 B | 1 x $\frac{3}{8}$ "x165,0 |
| ○ | 8794 B | 1 x $\frac{3}{8}$ "x76,0 |
| ○ | 8795 B | 1 x $\frac{3}{8}$ "x50,0 |
| ○ | 8784 B1 | 1 x $\frac{1}{4}$ "x3/8"x44,0 |
| ○ | 8796 SB | 1 x $\frac{3}{8}$ "x125,0 |
| ○ | 8796 LB | 1 x $\frac{3}{8}$ "x200,0 |
| ⊕ | 867/1 Z TORX® B0 | 1 x TX 10x25; 1 x TX 15x25; 1 x TX 20x25; 1 x TX 25x25; 1 x TX 27x25; 1 x TX 30x25; 1 x TX 40x25 |
| ⊖ | 800/1 Z | 1 x 1,0x5,5x25 |
| ⊕ | 851/1 Z PH | 1 x PH 2x25; 1 x PH 3x25 |
| ⊕ | 855/1 Z PZ | 1 x PZ 2x25; 1 x PZ 3x25 |
| ○ | 840/1 Z Hex-Plus | 1 x $\frac{5}{64}$ "x25; 1 x $\frac{3}{32}$ "x25; 1 x $\frac{1}{8}$ "x25; 1 x $\frac{9}{64}$ "x25; 1 x $\frac{5}{32}$ "x25; 1 x $\frac{3}{16}$ "x25; 1 x $\frac{7}{32}$ "x25 |

8000 B Zyklop Speed Ratchet with $\frac{3}{8}$ " drive



Application: $\frac{3}{8}$ " square drive sockets and $\frac{3}{8}$ " adaptors with square drive, equipped with ball lock

Design: Flywheel design and easy-to-grip free-turning sleeve for faster work, swivel ratchet head, defined lock positions at 0° and 90° to the left and right as well as at 15° before 90° inwards, at 0° it can be used like a conventional screwdriver, pushbutton release, left/right switchover, fine-tooth design, small return angle of 5°

Handle: Multi-component Kraftform handle ensures minimum fatigue

| | | |
|-------------|-----------------|----------|
| | | |
| 05003550001 | $\frac{3}{8}$ " | 199,0 mm |

8000 B SB Zyklop Speed Ratchet with $\frac{3}{8}$ " drive

| | | |
|-------------|---------------------------|-------------------|
| | | |
| 05073261001 | 1 x $\frac{3}{8}$ "x199,0 | 4013288 128041 |





Tip

How to notice missing tools more quickly



Perfectly conceived in every detail: the storage case for the ZykloSpeed ratchet sets! The two-tone foam insert section means that the tools can be quickly and reliably replaced, and that missing tools can be detected immediately. The tools and their position can be clearly seen in the lid where they have been laser-etched, ensuring

that they are legible even when the insert section is covered with grease, dirt or oil. Additionally, the foam section can be removed and placed in the drawer of a tool cabinet or trolley.



“Flexible-lock-system”

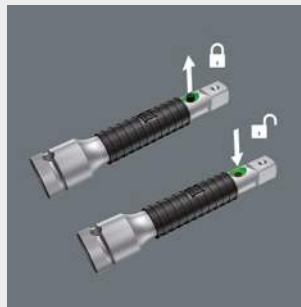

The extensions from the premium lines are also equipped with the unique “flexible-lock-system”. By activating this system, attachments can be fixed to the extension permanently – preventing slipping and any unintentional loss of the attachment. When the system is deactivated, the sockets can be attached as usual and changed in a flash.



The Zyklo VDE ratchet and accessories



The Zyklo VDE ratchet with 3/8" drive and the accessories can be found on pages 124-129.

The Zyklop Metal Ratchets Push, $\frac{3}{8}$ "

With push-through square

8100 SB 7 Zyklop Metal Ratchet Set with push-through square, $\frac{3}{8}$ " drive, metric

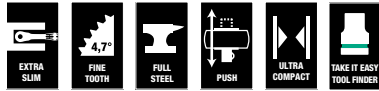

29-piece set; in a surface-preserving, compact and extremely robust textile box; low volume and weight for simplified mobility

1 Zyklop Metal Ratchet with $\frac{3}{8}$ " drive, 9 Zyklop sockets, 1 Zyklop extension (long) with free-turning sleeve, 1 wobble extension, 1 adaptor with quick-release chuck, 16 bits

| | |
|------------------|--|
| 05004047001 | |
| 8003 B | 1 x 3/8"x222,0 |
| 8790 HMB | 1 x 8,0x29,0; 1 x 10,0x29,0; 1 x 12,0x29,0; 1 x 13,0x29,0; 1 x 15,0x29,0; 1 x 16,0x30,0; 1 x 17,0x30,0; 1 x 18,0x30,0; 1 x 19,0x30,0 |
| 8794 LB | 1 x 3/8"x200,0 |
| 8794 B | 1 x 3/8"x76,0 |
| 8784 B1 | 1 x 1/4"x3/8"x44,0 |
| 851/1 Z PH | 1 x PH 1x25; 1 x PH 2x25; 1 x PH 3x25 |
| 855/1 Z PZ | 1 x PZ 1x25; 1 x PZ 2x25 |
| 867/1 Z TORX® | 1 x TX 15x25; 1 x TX 20x25; 1 x TX 25x25; 1 x TX 27x25; 1 x TX 30x25; 1 x TX 40x25 |
| 840/1 Z Hex-Plus | 1 x 3,0x25; 1 x 4,0x25; 1 x 5,0x25; 1 x 6,0x25; 1 x 8,0x25 |

8100 SB 10 Zyklop Metal Ratchet Set with push-through square, $\frac{3}{8}$ " drive, imperial

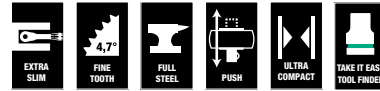

29-piece set; in a surface-preserving, compact and extremely robust textile box; low volume and weight for simplified mobility

1 Zyklop Metal Ratchet with $\frac{3}{8}$ " drive, 9 Zyklop sockets, 1 Zyklop extension (long) with free-turning sleeve, 1 wobble extension, 1 adaptor with quick-release chuck, 16 bits

| | |
|------------------|--|
| 05004050001 | |
| 8003 B | 1 x 3/8"x222,0 |
| 8790 HMB | 1 x 1/4"x29,0; 1 x 5/16"x29,0; 1 x 3/8"x29,0; 1 x 7/16"x29,0; 1 x 1/2"x29,0; 1 x 9/16"x29,0; 1 x 5/8"x30,0; 1 x 11/16"x30,0; 1 x 3/4"x30,0 |
| 8794 LB | 1 x 3/8"x200,0 |
| 8794 B | 1 x 3/8"x76,0 |
| 8784 B1 | 1 x 1/4"x3/8"x44,0 |
| 851/1 Z PH | 1 x PH 1x25; 1 x PH 2x25; 1 x PH 3x25 |
| 855/1 Z PZ | 1 x PZ 1x25; 1 x PZ 2x25 |
| 867/1 Z TORX® | 1 x TX 15x25; 1 x TX 20x25; 1 x TX 25x25; 1 x TX 27x25; 1 x TX 30x25; 1 x TX 40x25 |
| 840/1 Z Hex-Plus | 1 x 5/32"x25; 1 x 3/16"x25; 1 x 7/32"x25; 1 x 1/4"x25; 1 x 5/16"x25 |

8003 B Zyklop Metal Ratchet with push-through square and $\frac{3}{8}$ " drive



Application: $\frac{3}{8}$ " square sockets as well as for $\frac{3}{8}$ " adaptors with square drive, with ball locking device

Design: Forged, full metal ratchet (chrome-molybdenum) that is extremely robust with a long service life; slim design to enable work in very confined spaces; the dual-ratchet-teeth design means that a 76 fine-toothing division can be achieved from the 38 robust teeth with a return angle of only 4.7°; simple direction change with the undetachable push-through square and very secure socket lock mechanism

| | | | | |
|-------------|-----------------|-------|----|----|
| | | | | |
| | | mm | mm | mm |
| 05004033001 | $\frac{3}{8}$ " | 222,0 | 27 | 29 |

Tip

The Zyklop Metal Ratchets Push



Forged, full metal ratchet (chrome-molybdenum) that is extremely robust with a long service life; slim design to enable work in very confined spaces.

Textile boxes



The textile boxes offer dramatically improved portability, and are space-saving to boot!

This means you can now carry the same collection of tools, in a much more compact and comfortable package. The hassle of running back and forth for the right tools has now become a thing of the past. And the much lower weight of a set makes carrying more convenient than ever before. The textile box including the tool will even survive a fall undamaged. And: it leaves absolutely no signs of scratches on sensitive surfaces.



The Zyklop VDE ratchet and accessories



The Zyklop VDE ratchet with $\frac{3}{8}$ " drive and the accessories can be found on pages 124-129.

The Zyklop Metal Ratchets Switch, $\frac{3}{8}$ "

With switch lever

8100 SB 8 Zyklop Metal Ratchet Set with switch lever, $\frac{3}{8}$ " drive, metric



29-piece set; in a surface-preserving, compact and extremely robust textile box; low volume and weight for simplified mobility

1 Zyklop Metal Ratchet with $\frac{3}{8}$ " drive, 9 Zyklop sockets, 1 Zyklop extension (long) with free-turning sleeve, 1 wobble extension, 1 adaptor with quick-release chuck, 16 bits

| | | |
|-------------|------------------|--|
| 05004048001 | | |
| ○ | 8004 B | 1 x 3/8"x222,0 |
| ● | 8790 HMB | 1 x 8,0x29,0; 1 x 10,0x29,0; 1 x 12,0x29,0; 1 x 13,0x29,0; 1 x 15,0x29,0; 1 x 16,0x30,0; 1 x 17,0x30,0; 1 x 18,0x30,0; 1 x 19,0x30,0 |
| ⊗ | 8794 LB | 1 x 3/8"x200,0 |
| ⊗ | 8794 B | 1 x 3/8"x76,0 |
| ⊗ | 8784 B1 | 1 x 1/4"x3/8"x44,0 |
| + | 851/1 Z PH | 1 x PH 1x25; 1 x PH 2x25; 1 x PH 3x25 |
| + | 855/1 Z PZ | 1 x PZ 1x25; 1 x PZ 2x25 |
| ⊗ | 867/1 Z TORX® | 1 x TX 15x25; 1 x TX 20x25; 1 x TX 25x25; 1 x TX 27x25; 1 x TX 30x25; 1 x TX 40x25 |
| ○ | 840/1 Z Hex-Plus | 1 x 3,0x25; 1 x 4,0x25; 1 x 5,0x25; 1 x 6,0x25; 1 x 8,0x25 |

8100 SB 11 Zyklop Metal Ratchet Set with switch lever, $\frac{3}{8}$ " drive, imperial

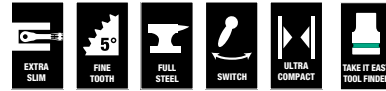

29-piece set; in a surface-preserving, compact and extremely robust textile box; low volume and weight for simplified mobility

1 Zyklop Metal Ratchet with $\frac{3}{8}$ " drive, 9 Zyklop sockets, 1 Zyklop extension (long) with free-turning sleeve, 1 wobble extension, 1 adaptor with quick-release chuck, 16 bits

| | | |
|-------------|------------------|--|
| 05004051001 | | |
| ○ | 8004 B | 1 x 3/8"x222,0 |
| ● | 8790 HMB | 1 x 1/4"x29,0; 1 x 5/16"x29,0; 1 x 3/8"x29,0; 1 x 7/16"x29,0; 1 x 1/2"x29,0; 1 x 9/16"x29,0; 1 x 5/8"x30,0; 1 x 11/16"x30,0; 1 x 3/4"x30,0 |
| ⊗ | 8794 LB | 1 x 3/8"x200,0 |
| ⊗ | 8794 B | 1 x 3/8"x76,0 |
| ⊗ | 8784 B1 | 1 x 1/4"x3/8"x44,0 |
| + | 851/1 Z PH | 1 x PH 1x25; 1 x PH 2x25; 1 x PH 3x25 |
| + | 855/1 Z PZ | 1 x PZ 1x25; 1 x PZ 2x25 |
| ⊗ | 867/1 Z TORX® | 1 x TX 15x25; 1 x TX 20x25; 1 x TX 25x25; 1 x TX 27x25; 1 x TX 30x25; 1 x TX 40x25 |
| ○ | 840/1 Z Hex-Plus | 1 x 5/32"x25; 1 x 3/16"x25; 1 x 7/32"x25; 1 x 1/4"x25; 1 x 5/16"x25 |

8100 SB HF 1 Zyklop Metal Ratchet Set with switch lever, 3/8" drive, with holding function, metric



13-piece set; in a surface-preserving, compact and extremely robust textile box; low volume and weight for simplified mobility. Non-woven reverse side and hook and loop strips for simple attachment e.g. to a wall, shelf, tool trolley and to the Wera 2go tool transport system. Fast and easy Twist to Unlock mechanism for secure storage and simple removal of the sockets.

1 Zyklop Metal Ratchet with 3/8" drive, 9 Zyklop sockets with 3/8" drive with fastener holding function. Take it easy tool finder: Colour coding to enable the desired socket to be easily selected. 1 tool for the simple removal of nuts from sockets with holding function, 1 Zyklop extension (long) with free-turning sleeve, 1 wobble extension

| Icon | Part Number | Description |
|------|---------------|---|
| ● | 8004 B | 1 x 3/8"x222,0 |
| ● | 8790 HMB HF | 1 x 8,0x29,0; 1 x 10,0x29,0; 1 x 12,0x29,0; 1 x 13,0x29,0; 1 x 15,0x29,0; 1 x 16,0x29,0; 1 x 17,0x29,0; 1 x 18,0x29,0; 1 x 19,0x29,0 |
| ● | 8794 LB | 1 x 3/8"x200,0 |
| ● | 8794 B | 1 x 3/8"x76,0 |
| | Nut Extractor | 1 x 14,0x43,0 |

8004 B Zyklop Metal Ratchet with switch lever and 3/8" drive

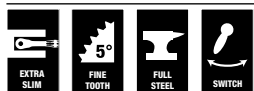

Application: 3/8" square sockets as well as for 3/8" adaptors with square drive, with ball locking device

Design: Forged, full metal ratchet (chrome-molybdenum) that is extremely robust with a long service life; slim design to enable work in very confined spaces; fine-tooth mechanism with 72 teeth for a return angle of only 5°; switch lever for convenient change of direction; secure socket locking function

| Icon | Part Number | Drive | Length (mm) | Width (mm) | Height (mm) |
|------|-------------|-------|-------------|------------|-------------|
| ● | 05004034001 | 3/8" | 222,0 | 26 | 29 |

Tip

The Zyklop Metal Ratchets Switch



Extremely slim. Long leverage. Very robust without any torque limitation. Forged, full metal ratchet out of chrome molybdenum.



The Zyklop VDE ratchet and accessories



The Zyklop VDE ratchet with 3/8" drive and the accessories can be found on pages 124-129.



"Take it easy"



"Take it easy" tool finder system – with profile and size colour-coding for quick and easy tool selection. Colour-coded system for hexagon drive screws (L-Keys, Zyklop bit sockets), external hex drive screws and nuts (Joker wrenches, Zyklop sockets and Zyklop bit sockets with holding function), and TORX® drive screws (L-Keys, Zyklop bit sockets).

Zyklop Accessories, $\frac{3}{8}$ "

With amazing product benefits

8790 HMB Zyklop $\frac{3}{8}$ " socket



Application: Hexagon headed bolts, screws and nuts





























Design: Manual and (non-impact) machine applications, ball intercept ring, knurls at base for precision handling in manual operations, chrome vanadium, brushed chrome-plated finish
Take it easy toolfinder: Colour coding to enable the desired socket to be easily located.



















8790 HMB HF Zyklop socket with $\frac{3}{8}$ " drive with holding function



Application: Hexagon headed bolts, screws and nuts

Design: Manual and (non-impact) machine applications, ball intercept ring, knurls at base for precision handling in manual operations, with holding function, chrome vanadium, brushed chrome-plated finish. Take it easy tool finder: Colour coding and large stamp to enable the desired socket to be easily located.

| | |  |  |  |  |  |  |
|-------------|---|---|---|---|---|---|---|
| | | mm | mm | mm | mm | mm | mm |
| 05003551001 |  | 6,0 | 29,0 | 10,5 | 18,0 | 12,0 | |
| 05003552001 |  | 7,0 | 29,0 | 11,0 | 18,0 | 12,0 | |
| 05003553001 |  | 8,0 | 29,0 | 12,2 | 18,0 | 12,0 | |
| 05003554001 |  | 9,0 | 29,0 | 13,5 | 18,0 | 12,0 | |
| 05003555001 |  | 10,0 | 29,0 | 14,5 | 18,0 | 12,0 | |
| 05003556001 |  | 11,0 | 29,0 | 16,0 | 18,0 | 12,0 | |
| 05003557001 |  | 12,0 | 29,0 | 17,0 | 18,0 | 12,0 | |
| 05003558001 |  | 13,0 | 29,0 | 18,5 | 20,0 | 12,0 | |
| 05003559001 |  | 14,0 | 29,0 | 19,5 | 22,0 | 12,0 | |
| 05003560001 | | 15,0 | 29,0 | 21,0 | 24,0 | 12,0 | |
| 05003561001 |  | 16,0 | 30,0 | 22,0 | 24,0 | 12,0 | |
| 05003562001 |  | 17,0 | 30,0 | 23,5 | 24,0 | 12,0 | |
| 05003563001 |  | 18,0 | 30,0 | 24,5 | 24,0 | 18,0 | |
| 05003564001 |  | 19,0 | 30,0 | 26,0 | 24,0 | 18,0 | |
| 05003565001 | | 20,0 | 30,0 | 28,0 | 25,0 | 18,0 | |
| 05003566001 | | 21,0 | 30,0 | 28,0 | 25,0 | 18,0 | |
| 05003567001 | | 22,0 | 30,0 | 32,0 | 25,0 | 18,0 | |
| 05003568001 | | 24,0 | 32,0 | 32,0 | 25,0 | 20,0 | |
| 05003569001 |  | $\frac{1}{4}$ " | 29,0 | 11,0 | 18,0 | 12,0 | |
| 05003570001 |  | $\frac{5}{16}$ " | 29,0 | 12,2 | 18,0 | 12,0 | |
| 05003571001 |  | $\frac{11}{32}$ " | 29,0 | 13,5 | 18,0 | 12,0 | |
| 05003572001 |  | $\frac{3}{8}$ " | 29,0 | 14,5 | 18,0 | 12,0 | |
| 05003573001 |  | $\frac{7}{16}$ " | 29,0 | 16,0 | 18,0 | 12,0 | |
| 05003574001 |  | $\frac{1}{2}$ " | 29,0 | 18,5 | 20,0 | 12,0 | |
| 05003575001 |  | $\frac{9}{16}$ " | 29,0 | 19,5 | 22,0 | 12,0 | |
| 05003576001 |  | $\frac{5}{8}$ " | 30,0 | 22,0 | 24,0 | 12,0 | |
| 05003577001 |  | $\frac{11}{16}$ " | 30,0 | 23,0 | 24,0 | 18,0 | |
| 05003578001 |  | $\frac{3}{4}$ " | 30,0 | 26,0 | 24,0 | 18,0 | |
| 05003579001 | | $\frac{13}{16}$ " | 30,0 | 28,0 | 25,0 | 18,0 | |
| 05003580001 | | $\frac{7}{8}$ " | 30,0 | 32,0 | 25,0 | 18,0 | |

| | |  |  |  |  |  |
|-------------|---|---|---|---|---|---|
| | | mm | mm | mm | mm | mm |
| 05003740001 |  | 6,0 | 29,0 | 10,5 | 17,5 | 6,5 |
| 05003741001 |  | 7,0 | 29,0 | 11,2 | 17,5 | 6,5 |
| 05003742001 |  | 8,0 | 29,0 | 12,2 | 17,5 | 6,5 |
| 05003743001 |  | 9,0 | 29,0 | 13,7 | 17,5 | 6,5 |
| 05003744001 |  | 10,0 | 29,0 | 15,0 | 17,5 | 8,0 |
| 05003745001 |  | 11,0 | 29,0 | 16,2 | 17,5 | 9,5 |
| 05003746001 |  | 12,0 | 29,0 | 17,0 | 17,5 | 9,5 |
| 05003747001 |  | 13,0 | 29,0 | 18,4 | 19,5 | 9,5 |
| 05003748001 |  | 14,0 | 29,0 | 19,5 | 21,5 | 12,5 |
| 05003749001 | | 15,0 | 29,0 | 21,0 | 23,5 | 12,5 |
| 05003750001 |  | 16,0 | 29,0 | 22,2 | 23,5 | 12,5 |
| 05003751001 |  | 17,0 | 29,0 | 24,0 | 23,5 | 12,5 |
| 05003752001 |  | 18,0 | 29,0 | 24,5 | 23,5 | 12,5 |
| 05003753001 |  | 19,0 | 29,0 | 26,0 | 23,5 | 12,5 |

Belt B 1 Zyklop socket set with holding function, $\frac{3}{8}$ " drive



10-piece; robust textile socket belt, including snap hook to enable secure fastening to a belt loop or pocket. Non-woven reverse side and hook and loop strips for simple attachment e.g. to a wall, shelf, tool trolley and to the Wera 2go tool transport system. Fast and easy Twist to Unlock mechanism for secure storage and simple removal of the sockets.

9 Zyklop sockets with $\frac{3}{8}$ " drive with fastener holding function. Take it easy tool finder: Colour coding to enable the desired socket to be easily selected. 1 tool for the simple removal of nuts from sockets with holding function.

| | |
|---------------------------------|---|
| 05003970001 | |
| 8790 HMB HF | 1 x 8,0x29,0; 1 x 10,0x29,0; 1 x 12,0x29,0; 1 x 13,0x29,0; 1 x 15,0x29,0; 1 x 16,0x29,0; 1 x 17,0x29,0; 1 x 18,0x29,0; 1 x 19,0x29,0 |
| Nut Extractor | 1 x 14,0x43,0 |
| Belt B 0/9 | 1 x 45,0x310,0 |
| Hook and Loop Fastener Strip 30 | 1 x 30,0x200,0 |

Belt B 4 Zyklop socket set, $\frac{3}{8}$ " drive



9-piece; robust textile socket belt, including snap hook to enable secure fastening to a belt loop or pocket. Non-woven reverse side and hook and loop strips for simple attachment e.g. to a wall, shelf, tool trolley and to the Wera 2go tool transport system. Smooth turning Fast and easy Twist to Unlock mechanism for secure storage and simple removal of the sockets.

9 Zyklop sockets with $\frac{3}{8}$ " drive. Take it easy tool finder: Colour coding to enable the desired socket to be easily selected.

| | |
|---------------------------------|--|
| 05003973001 | |
| 8790 HMB | 1 x 8,0x29,0; 1 x 10,0x29,0; 1 x 12,0x29,0; 1 x 13,0x29,0; 1 x 15,0x29,0; 1 x 16,0x30,0; 1 x 17,0x30,0; 1 x 18,0x30,0; 1 x 19,0x30,0 |
| Belt B 0/9 | 1 x 45,0x310,0 |
| Hook and Loop Fastener Strip 30 | 1 x 30,0x200,0 |

Tip

How to avoid the need for two socket sets – one for manual and one for machine operations



The manual and machine sockets can be used both for hand and power tools use (non-impact). Users need just one socket set for all applications.



Textile belt



The textile belt can be attached by means of the nonwoven reverse side and the hook and loop strips e.g. to a wall, shelf, tool trolley and to the Wera 2go tool transport system.



"Take it easy"



"Take it easy" tool finder system – with profile and size colour-coding for quick and easy tool selection. Colour-coded system for hexagon drive screws (L-Keys, Zyklop bit sockets), external hex drive screws and nuts (Joker wrenches, Zyklop sockets and Zyklop bit sockets with holding function), and TORX® drive screws (L-Keys, Zyklop bit sockets).

Zyklop Accessories, $\frac{3}{8}$ "

With amazing product benefits

Nut Extractor



Tool made out of synthetic plastic material (TPE) for the simple removal of nuts from sockets with holding function.

| | | |
|-------------|------|------|
| | | |
| | mm | mm |
| 05050005001 | 14,0 | 43,0 |

8767 B HF TORX® Zyklop bit socket with holding function, $\frac{3}{8}$ " drive



Application: TORX® socket screws

Design: Manual and (non-impact) machine applications, ball intercept ring, knurls at base for precision handling in manual operations, bit sockets with all the advantages of the Wera bit technology, brushed chrome-plated finish, holding function for TORX® screws made according to Acument Intellectual Properties specifications. Take it easy tool finder: Colour coding to enable the desired bit socket to be easily located.

| | | | mm | mm | mm | mm |
|-------------|--|-------|-------|------|------|------|
| 05003059001 | | TX 10 | 35,0 | 12,0 | 17,5 | 9,0 |
| 05003060001 | | TX 15 | 35,0 | 12,0 | 17,5 | 9,0 |
| 05003061001 | | TX 20 | 35,0 | 12,0 | 17,5 | 9,0 |
| 05003062001 | | TX 25 | 35,0 | 12,0 | 17,5 | 9,0 |
| 05003063001 | | TX 25 | 107,0 | 12,0 | 17,5 | 81,0 |
| 05003064001 | | TX 27 | 35,0 | 12,0 | 17,5 | 9,0 |
| 05003065001 | | TX 27 | 107,0 | 12,0 | 17,5 | 81,0 |
| 05003066001 | | TX 30 | 35,0 | 12,0 | 17,5 | 9,0 |
| 05003067001 | | TX 30 | 107,0 | 12,0 | 17,5 | 81,0 |
| 05003068001 | | TX 40 | 35,0 | 12,0 | 17,5 | 9,0 |
| 05003069001 | | TX 40 | 107,0 | 12,0 | 17,5 | 81,0 |
| 05003070001 | | TX 45 | 38,5 | 12,0 | 17,5 | 12,5 |
| 05003071001 | | TX 45 | 100,0 | 12,0 | 17,5 | 74,5 |
| 05003072001 | | TX 50 | 38,5 | 12,0 | 17,5 | 12,5 |
| 05003073001 | | TX 50 | 100,0 | 12,0 | 17,5 | 74,5 |

Belt B 3 TORX® HF Zyklop bit socket set with holding function, $\frac{3}{8}$ " drive



9-piece; robust textile socket belt, including snap hook to enable secure fastening to a belt loop or pocket. Non-woven reverse side and hook and loop strips for simple attachment e.g. to a wall, shelf, tool trolley and to the Wera 2go tool transport system. Fast and easy Twist to Unlock mechanism for secure storage and simple removal of the tool sockets.

9 Zyklop bit sockets for TORX® screws, with $\frac{3}{8}$ " drive, with holding function. Take it easy tool finder: Colour coding to enable the desired bit socket to be easily selected.

| 05003972001 | | |
|-------------|---------------------------------|---|
| | 8767 B HF | 1 x TX 10x35,0; 1 x TX 15x35,0; 1 x TX 20x35,0; 1 x TX 25x35,0; 1 x TX 27x35,0; 1 x TX 30x35,0; 1 x TX 40x35,0; 1 x TX 45x38,5; 1 x TX 50x38,5 |
| | Belt B 0/9 | 1 x 45,0x310,0 |
| | Hook and Loop Fastener Strip 30 | 1 x 30,0x200,0 |

8767 B TORX® HF 1 Zyklop bit socket set with holding function, $\frac{3}{8}$ " drive



6-piece set

Pouch with 100 mm/107 mm bit sockets

6 Zyklop bit sockets for TORX® screws, with $\frac{3}{8}$ " drive, with holding function. Take it easy tool finder: Colour coding to enable the desired bit socket to be easily selected.

| 05003185001 | | |
|-------------|-----------|--|
| | 8767 B HF | 1 x TX 25x107,0; 1 x TX 27x107,0; 1 x TX 30x107,0; 1 x TX 40x107,0; 1 x TX 45x100,0; 1 x TX 50x100,0 |

8740 B HF Zyklop bit socket bit socket with holding function, $\frac{3}{8}$ " drive



Application: Hexagon socket screws

Design: Manual and (non-impact) machine applications, ball intercept ring, knurls at base for precision handling in manual operations, bit sockets with all the advantages of the Wera bit technology, brushed chrome-plated finish, holding function for hexagon socket screws. Take it easy tool finder: Colour coding to enable the desired bit socket to be easily located.

| | mm | mm | mm | mm | mm | mm |
|-------------|------|------------------|-------|------|------|------|
| 05003030001 | 3,0 | | 35,0 | 12,0 | 17,5 | 9,0 |
| 05003031001 | 4,0 | | 35,0 | 12,0 | 17,5 | 9,0 |
| 05003032001 | 4,0 | | 107,0 | 12,0 | 17,5 | 81,0 |
| 05003033001 | 5,0 | | 35,0 | 12,0 | 17,5 | 9,0 |
| 05003034001 | 5,0 | | 107,0 | 12,0 | 17,5 | 81,0 |
| 05003035001 | 6,0 | | 35,0 | 12,0 | 17,5 | 9,0 |
| 05003036001 | 6,0 | | 107,0 | 12,0 | 17,5 | 81,0 |
| 05003037001 | 7,0 | | 38,5 | 12,0 | 17,5 | 12,5 |
| 05003038001 | 7,0 | | 100,0 | 12,0 | 17,5 | 74,5 |
| 05003039001 | 8,0 | | 38,5 | 12,0 | 17,5 | 12,5 |
| 05003040001 | 8,0 | | 100,0 | 12,0 | 17,5 | 74,5 |
| 05003041001 | 9,0 | | 38,5 | 12,0 | 17,5 | 12,5 |
| 05003042001 | 9,0 | | 100,0 | 12,0 | 17,5 | 74,5 |
| 05003043001 | 10,0 | | 38,5 | 12,0 | 17,5 | 12,5 |
| 05003044001 | 10,0 | | 100,0 | 12,0 | 17,5 | 74,5 |
| 05003080001 | | $\frac{1}{8}$ " | 35,0 | 12,0 | 17,5 | 9,0 |
| 05003081001 | | $\frac{1}{8}$ " | 107,0 | 12,0 | 17,5 | 81,0 |
| 05003082001 | | $\frac{9}{64}$ " | 35,0 | 12,0 | 17,5 | 9,0 |
| 05003083001 | | $\frac{5}{32}$ " | 35,0 | 12,0 | 17,5 | 9,0 |
| 05003084001 | | $\frac{5}{32}$ " | 107,0 | 12,0 | 17,5 | 81,0 |
| 05003085001 | | $\frac{3}{16}$ " | 35,0 | 12,0 | 17,5 | 9,0 |
| 05003086001 | | $\frac{3}{16}$ " | 107,0 | 12,0 | 17,5 | 81,0 |
| 05003087001 | | $\frac{7}{32}$ " | 35,0 | 12,0 | 17,5 | 9,0 |
| 05003088001 | | $\frac{7}{32}$ " | 107,0 | 12,0 | 17,5 | 81,0 |
| 05003089001 | | $\frac{1}{4}$ " | 35,0 | 12,0 | 17,5 | 9,0 |
| 05003090001 | | $\frac{1}{4}$ " | 107,0 | 12,0 | 17,5 | 81,0 |
| 05003091001 | | $\frac{5}{16}$ " | 38,5 | 12,0 | 17,5 | 12,5 |
| 05003092001 | | $\frac{5}{16}$ " | 100,0 | 12,0 | 17,5 | 74,5 |
| 05003093001 | | $\frac{3}{8}$ " | 38,5 | 12,0 | 17,5 | 12,5 |
| 05003094001 | | $\frac{3}{8}$ " | 100,0 | 12,0 | 17,5 | 74,5 |

Tip

Nut extractor tool



This tool enables hexagon nuts to be easily removed from sockets with holding function.



Bit sockets with retaining function for hexagon socket screws



The clamping of the screw is achieved by a flexible locking ball. The holding function is especially helpful in confined, hard-to-reach spaces, where there is no room for a second hand to secure the screw.

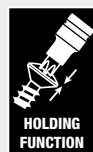

Bit sockets with holding function for TORX® screws



The HF tools developed by Wera are ideal because they feature an optimised geometry of the original TORX® profile. The wedging forces resulting from the surface pressure between the drive tip and the screw profile mean that TORX® screws made according to Acument Intellectual Properties specifications are securely held on the tool!

Zyklop Accessories, $\frac{3}{8}$ "

With amazing product benefits

Belt B 2 Zyklop In-Hex-Plus bit socket set with holding function, $\frac{3}{8}$ " drive



8-piece; robust textile socket belt, including snap hook to enable secure fastening to a belt loop or pocket. Non-woven reverse side and hook and loop strips for simple attachment e.g. to a wall, shelf, tool trolley and to the Wera 2go tool transport system. Fast and easy Twist to Unlock mechanism for secure storage and simple removal of the sockets.

8 bit sockets for hexagon socket screws with $\frac{3}{8}$ " drive with holding function and Hex-Plus high torque geometry. Take it easy tool finder: Colour coding to enable the desired bit socket to be easily selected.

| | |
|-------------|--|
| 05003971001 | |
| ○ | 8740 B HF 1 x 3,0x35,0; 1 x 4,0x35,0; 1 x 5,0x35,0; 1 x 6,0x35,0; 1 x 7,0x38,5; 1 x 8,0x38,5; 1 x 9,0x38,5; 1 x 10,0x38,5 |
| | Belt B 0/8 1 x 45,0x275,0 |
| | Hook and Loop Fastener Strip 30 1 x 30,0x200,0 |

8740 B HF 1 Zyklop bit socket set with holding function, $\frac{3}{8}$ " drive



7-piece set

Pouch with 100 mm/107 mm bit sockets

7 Zyklop bit sockets for hexagon socket screws, with $\frac{3}{8}$ " drive, with holding function, Take it easy tool finder: Colour coding to enable the desired bit socket to be easily located.

| | |
|-------------|---|
| 05003180001 | |
| ○ | 8740 B HF 1 x 4,0x107,0; 1 x 5,0x107,0; 1 x 6,0x107,0; 1 x 7,0x100,0; 1 x 8,0x100,0; 1 x 9,0x100,0; 1 x 10,0x100,0 |

8740 B HF Imperial 1 Zyklop bit socket set with holding function, $\frac{3}{8}$ " drive



7-piece set

Pouch with 100 mm/107 mm bit sockets

7 Zyklop bit sockets for hexagon socket screws, with $\frac{3}{8}$ " drive, with holding function, Take it easy tool finder: Colour coding to enable the desired bit socket to be easily located.

| | |
|-------------|---|
| 05003181001 | |
| ○ | 8740 B HF 1 x 1/8"x107,0; 1 x 5/32"x107,0; 1 x 3/16"x107,0; 1 x 7/32"x107,0; 1 x 1/4"x107,0; 1 x 5/16"x100,0; 1 x 3/8"x100,0 |

Belt B Imperial 1 Zyklop In-Hex-Plus bit socket set with holding function, $\frac{3}{8}$ " drive



8-piece; robust textile socket belt, including snap hook to enable secure fastening to a belt loop or pocket. Non-woven reverse side and hook and loop strips for simple attachment e.g. to a wall, shelf, tool trolley and to the Wera 2go tool transport system. Fast and easy Twist to Unlock mechanism for secure storage and simple removal of the sockets.

8 bit sockets for hexagon socket screws with $\frac{3}{8}$ " drive with holding function and Hex-Plus high torque geometry. Take it easy tool finder: Colour coding to enable the desired bit socket to be easily selected.

| | |
|-------------|--|
| 05003974001 | |
| ○ | 8740 B HF 1 x 1/8"x35,0; 1 x 9/64"x35,0; 1 x 5/32"x35,0; 1 x 3/16"x35,0; 1 x 7/32"x35,0; 1 x 1/4"x35,0; 1 x 5/16"x38,5; 1 x 3/8"x38,5 |
| | Belt B 0/8 1 x 45,0x275,0 |
| | Hook and Loop Fastener Strip 30 1 x 30,0x200,0 |

Socket rail B (textile belt), 9 location, unloaded



1 robust textile belt, unloaded, for up to 9 sockets and/or bit sockets, with $\frac{3}{8}$ " drive. Comes with a snap hook to enable secure fastening to a belt loop or pocket. Non-woven reverse side and hook and loop strips for simple attachment e.g. to a wall, shelf, tool trolley and to the Wera 2go tool transport system. Fast and easy Twist to Unlock mechanism for secure storage and simple removal of the sockets.

| | | |
|-------------|--|----------------|
| 05003981001 | | |
| | Belt B 0/9 | 1 x 45,0x310,0 |
| | Hook and Loop Fastener Strip 30 | 1 x 30,0x200,0 |

Socket rail B (textile belt), 8 location, unloaded



1 robust textile belt, unloaded, for up to 8 sockets and/or bit sockets with $\frac{3}{8}$ " drive. Comes with a snap hook to enable secure fastening to a belt loop or pocket. Nonwoven reverse side and hook and loop strips for simple attachment e.g. to a wall, shelf, tool trolley and to the Wera 2go tool transport system. Fast and easy Twist to Unlock mechanism for secure storage and simple removal of the sockets.

| | | |
|-------------|--|----------------|
| 05003980001 | | |
| | Belt B 0/8 | 1 x 45,0x275,0 |
| | Hook and Loop Fastener Strip 30 | 1 x 30,0x200,0 |

Tip



Bit sockets with retaining function for hexagon socket screws



The clamping of the screw is achieved by a flexible locking ball. The holding function is especially helpful in confined, hard-to-reach spaces, where there is no room for a second hand to secure the screw.



Textile belt



The textile belt can be attached by means of the nonwoven reverse side and the hook and loop strips e.g. to a wall, shelf, tool trolley and to the Wera 2go tool transport system.

Comes with convenient snap hook



The robust textile belt can be secured to a belt loop or pocket by means of the snap hook.

Zyklop Accessories, $\frac{3}{8}$ "

With amazing product benefits

8796 SB Zyklop "flexible-lock" extension with free-turning sleeve, short, $\frac{3}{8}$ "



Application: $\frac{3}{8}$ " square drive sockets with ball lock

Design: Flexible-lock-system either for permanent interlocking or fast change of accessories, free-turning sleeve for rapid tightening or loosening of screws and nuts, chrome vanadium, brushed chrome-plated finish

| | | |
|-------------|-----------------|-------|
| | | |
| 05003591001 | $\frac{3}{8}$ " | 125,0 |

8794 SB Zyklop extension with free-turning sleeve, short, $\frac{3}{8}$ "



Application: $\frac{3}{8}$ " square drive sockets with ball lock

Design: Easy-to-grip free-turning sleeve for rapid tightening or loosening of screws and nuts, chrome vanadium, brushed chrome-plated finish

| | | |
|-------------|-----------------|-------|
| | | |
| 05003582001 | $\frac{3}{8}$ " | 125,0 |

8784 B1 Zyklop bit adaptor, $\frac{3}{8}$ "



Application: Suitable for $\frac{1}{4}$ " hex bits as per DIN ISO 1173-C 6,3 and E 6,3 and Wera series 1 and 4

Design: Quick-release chuck for fast bit changes, chromium vanadium

| | | | |
|-------------|-----------------|-----------------|------|
| | | | |
| 05003590001 | $\frac{1}{4}$ " | $\frac{3}{8}$ " | 44,0 |

8796 LB Zyklop "flexible-lock" extension with free-turning sleeve, long, $\frac{3}{8}$ "



Application: $\frac{3}{8}$ " square drive sockets with ball lock

Design: Flexible-lock-system either for permanent interlocking or fast change of accessories, free-turning sleeve for rapid tightening or loosening of screws and nuts, chrome vanadium, brushed chrome-plated finish

| | | |
|-------------|-----------------|-------|
| | | |
| 05003592001 | $\frac{3}{8}$ " | 200,0 |

8794 LB Zyklop extension with free-turning sleeve, long, $\frac{3}{8}$ "



Application: $\frac{3}{8}$ " square drive sockets with ball lock

Design: Easy-to-grip free-turning sleeve for rapid tightening or loosening of screws and nuts, chrome vanadium, brushed chrome-plated finish



| | | |
|-------------|-----------------|-------|
| | | |
| 05003583001 | $\frac{3}{8}$ " | 200,0 |

8789 B Zyklop sliding T-handle, 3/8"



Application: 3/8" square drive sockets with ball lock

Design: Sliding drive, chrome vanadium, brushed chrome-plated finish



| | | |
|---|---|-----------------------|
|  |  $\frac{3}{8}$ " | $\frac{1}{2}$ " mm |
| 05003581001 | $\frac{3}{8}$ " | 165,0 |

8795 B Zyklop universal joint, 3/8"



Application: 3/8" square drive sockets with ball lock

Design: Chrome vanadium/chrome molybdenum, brushed chrome-plated finish



| | | |
|---|---|-----------------------|
|  |  $\frac{3}{8}$ " | $\frac{1}{2}$ " mm |
| 05003585001 | $\frac{3}{8}$ " | 50,0 |

8794 B Zyklop wobble extension, 3/8"



Application: 3/8" square drive sockets with ball lock

Design: Swivels through 15°, chrome vanadium, brushed chrome-plated finish

| | | |
|---|---|-----------------------|
|  |  $\frac{3}{8}$ " | $\frac{1}{2}$ " mm |
| 05003584001 | $\frac{3}{8}$ " | 76,0 |

Tip



"Flexible-lock-system"



The extensions from the premium lines are also equipped with the unique "flexible-lock-system". By activating this system, attachments can be fixed to the extension permanently – preventing slipping and any unintentional loss of the attachment. When the system is deactivated, the sockets can be attached as usual and changed in a flash.







The free-turning sleeve



The free-turning sleeve effectively speeds up the tightening or loosening of screws and bolts.



Zyklop Ratchets, 1/2"

| | | |
|---|--|------------|
|  | Zyklop Speed | 190 |
|  | Zyklop Hybrid Ratchet | 194 |
|  | Zyklop Metal Push | 198 |
|  | Zyklop Metal Switch | 200 |
|  | Zyklop Accessories | 202 |
|  | 1/2" Koloss ratchet with hammer function | 210 |



The Zyklop Speed Ratchets, 1/2"

5 types of ratchet in 1 tool

8100 SC 6 Zyklop Speed Ratchet Set, 1/2" drive, metric

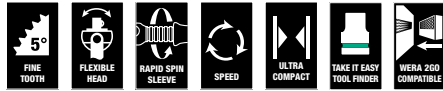

28-piece set; in a surface-preserving, compact and extremely robust textile box; low volume and weight for simplified mobility

1 Zyklop Speed Ratchet with 1/2" drive, 10 Zyklop sockets, 1 Zyklop extension (long) with free-turning sleeve, 1 wobble extension, 1 adaptor with quick-release chuck, 14 bits

| | | |
|-------------|---------------|--|
| 05004076001 | | |
| ⊙ | 8000 C | 1 x 1/2"x277,0 |
| ⊙ | 8790 HMC | 1 x 10,0x37,0; 1 x 11,0x37,0; 1 x 12,0x37,0; 1 x 13,0x37,0; 1 x 14,0x37,0; 1 x 15,0x37,0; 1 x 16,0x37,0; 1 x 17,0x37,0; 1 x 18,0x37,0; 1 x 19,0x37,0 |
| ⊙ | 8794 LC | 1 x 1/2"x250,0 |
| ⊙ | 8794 C | 1 x 1/2"x52,0 |
| ⊙ | 8784 C2 | 1 x 5/16"x1/2"x50,0 |
| + | 851/2 Z PH | 1 x PH 2x32; 1 x PH 3x32 |
| + | 855/2 Z PZ | 1 x PZ 2x32; 1 x PZ 3x32 |
| + | 867/2 Z TORX® | 1 x TX 20x35; 1 x TX 25x35; 1 x TX 30x35; 1 x TX 40x35; 1 x TX 45x35; 1 x TX 50x35 |
| ○ | 840/2 Z | 1 x 5x30; 1 x 6x30; 1 x 8x30; 1 x 10x30 |

8100 SC 9 Zyklop Speed Ratchet Set, 1/2" drive, imperial

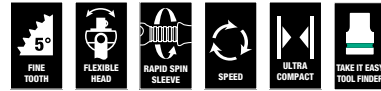

28-piece set; in a surface-preserving, compact and extremely robust textile box; low volume and weight for simplified mobility

1 Zyklop Speed Ratchet with 1/2" drive, 10 Zyklop sockets, 1 Zyklop extension (long) with free-turning sleeve, 1 wobble extension, 1 adaptor with quick-release chuck, 14 bits

| | | |
|-------------|---------------|--|
| 05004079001 | | |
| ⊙ | 8000 C | 1 x 1/2"x277,0 |
| ⊙ | 8790 HMC | 1 x 3/8"x37,0; 1 x 7/16"x37,0; 1 x 1/2"x37,0; 1 x 9/16"x37,0; 1 x 19/32"x37,0; 1 x 5/8"x37,0; 1 x 11/16"x37,0; 1 x 3/4"x37,0; 1 x 25/32"x37,0; 1 x 13/16"x37,0 |
| ⊙ | 8794 LC | 1 x 1/2"x250,0 |
| ⊙ | 8794 C | 1 x 1/2"x52,0 |
| ⊙ | 8784 C2 | 1 x 5/16"x1/2"x50,0 |
| + | 851/2 Z PH | 1 x PH 2x32; 1 x PH 3x32 |
| + | 855/2 Z PZ | 1 x PZ 2x32; 1 x PZ 3x32 |
| + | 867/2 Z TORX® | 1 x TX 20x35; 1 x TX 25x35; 1 x TX 30x35; 1 x TX 40x35; 1 x TX 45x35; 1 x TX 50x35 |
| ○ | 840/2 Z | 1 x 7/32"x30; 1 x 1/4"x30; 1 x 5/16"x30; 1 x 3/8"x30 |

8100 SC 2 Zyklop Speed Ratchet Set, 1/2" drive, metric

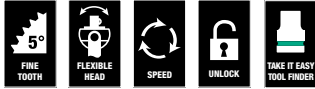

37-piece set in strong metal case

1 Zyklop ratchet with 1/2" drive, 17 Zyklop sockets (metric),

2 Zyklop "flexible-lock" extensions (short and long) with free-tuning sleeve, 1 sliding T-handle, 1 universal joint, 1 wobble extension, 1 adaptor with quick-release chuck, 13 bits

| | | |
|-------------|---------------|--|
| 05003645001 | | |
| ○ | 8000 C | 1 x 1/2"x277,0 |
| ● | 8790 HMC | 1 x 10,0x37,0; 1 x 11,0x37,0; 1 x 12,0x37,0; 1 x 13,0x37,0; 1 x 14,0x37,0; 1 x 15,0x37,0; 1 x 16,0x37,0; 1 x 17,0x37,0; 1 x 18,0x37,0; 1 x 19,0x37,0; 1 x 20,0x37,0; 1 x 21,0x37,0; 1 x 22,0x37,0; 1 x 24,0x37,0; 1 x 27,0x40,0; 1 x 30,0x42,0; 1 x 32,0x42,0 |
| ○ | 8789 C | 1 x 1/2"x250,0 |
| ○ | 8794 C | 1 x 1/2"x52,0 |
| ○ | 8795 C | 1 x 1/2"x69,0 |
| ○ | 8784 C2 | 1 x 5/16"x1/2"x50,0 |
| ○ | 8796 SC | 1 x 1/2"x125,0 |
| ○ | 8796 LC | 1 x 1/2"x250,0 |
| ○ | 840/2 Z | 1 x 5x30; 1 x 6x30; 1 x 8x30; 1 x 10x30 |
| + | 851/2 Z PH | 1 x PH 3x32 |
| + | 855/2 Z PZ | 1 x PZ 3x32 |
| ⊗ | 867/2 Z TORX® | 1 x TX 20x35; 1 x TX 25x35; 1 x TX 30x35; 1 x TX 40x35; 1 x TX 45x35; 1 x TX 50x35; 1 x TX 55x35 |

Tip

Zyklop "6 in 1"



1. Fine-tooth ratchet
2. Flex-head ratchet
3. Angle ratchet
4. Quick-release ratchet
5. Power ratchet
6. Screwdriver

New set concept



The textile boxes offer dramatically improved portability, and are space-saving to boot! This means you can now carry the same collection of tools, in a much more compact and comfortable package.



The hassle of running back and forth for the right tools has now become a thing of the past. And the much lower weight of a set makes carrying more convenient than ever before. The textile box including the tool will even survive a fall undamaged.



"Take it easy"



"Take it easy" tool finder system – with profile and size colour-coding for quick and easy tool selection. Colour-coded system for hexagon drive screws (L-Keys, Zyklop bit sockets), external hex drive screws and nuts (Joker wrenches, Zyklop sockets and Zyklop bit sockets with holding function), and TORX® drive screws (L-Keys, Zyklop bit sockets).

The Zyklop Speed Ratchets, 1/2"

5 types of ratchet in 1 tool

8100 SC 4 Zyklop Speed Ratchet Set, 1/2" drive, imperial

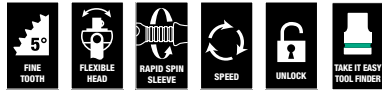

38-piece set in strong metal case

1 Zyklop ratchet with 1/2" drive, 18 Zyklop sockets (imperial),

2 Zyklop "flexible-lock" extensions (short and long) with free-tuning sleeve, 1 sliding T-handle, 1 universal joint, 1 wobble extension, 1 adaptor with quick-release chuck, 13 bits

| | | |
|-------------|---------------|---|
| 05003647001 | | |
| ○ | 8000 C | 1 x 1/2"x277,0 |
| ● | 8790 HMC | 1 x 3/8"x37,0; 1 x 7/16"x37,0; 1 x 1/2"x37,0; 1 x 9/16"x37,0; 1 x 19/32"x37,0; 1 x 5/8"x37,0; 1 x 11/16"x37,0; 1 x 3/4"x37,0; 1 x 25/32"x37,0; 1 x 13/16"x37,0; 1 x 7/8"x37,0; 1 x 15/16"x37,0; 1 x 31/32"x37,0; 1 x 1"x40,0; 1 x 1 1/16"x40,0; 1 x 1 1/8"x40,0; 1 x 1 3/16"x42,0; 1 x 1 1/4"x42,0 |
| ○ | 8789 C | 1 x 1/2"x250,0 |
| ○ | 8794 C | 1 x 1/2"x52,0 |
| ○ | 8795 C | 1 x 1/2"x69,0 |
| ○ | 8784 C2 | 1 x 5/16"x1/2"x50,0 |
| ○ | 8796 SC | 1 x 1/2"x125,0 |
| ○ | 8796 LC | 1 x 1/2"x250,0 |
| + | 851/2 Z PH | 1 x PH 3x32 |
| + | 855/2 Z PZ | 1 x PZ 3x32 |
| ⊕ | 867/2 Z TORX® | 1 x TX 20x35; 1 x TX 25x35; 1 x TX 30x35; 1 x TX 40x35; 1 x TX 45x35; 1 x TX 50x35; 1 x TX 55x35 |
| ○ | 840/2 Z | 1 x 7/32"x30; 1 x 1/4"x30; 1 x 5/16"x30; 1 x 3/8"x30 |

8000 C Zyklop Speed Ratchet with 1/2" drive



Application: 1/2" square drive sockets and 1/2" adapters with square drive, equipped with ball lock

Design: Flywheel design and easy-to-grip free-turning sleeve for faster work, swivel ratchet head, defined lock positions at 0° and 90° to the left and right as well as at 15° before 90° inwards, at 0° it can be used like a conventional screwdriver, pushbutton release, left/right switchover, fine-tooth design, small return angle of 5°

Handle: Multi-component Krafftform handle ensures minimum fatigue

| | | |
|-------------|------|--------|
| | | |
| | | mm |
| 05003600001 | 1/2" | 277,0 |

8000 C SB Zyklop Speed Ratchet with 1/2" drive

| | | |
|-------------|------------------|---------|
| | | |
| | | 4013288 |
| 05073262001 | ○ 1 x 1/2"x277,0 | 128058 |





The Zyklop Hybrid Ratchet, 1/2"



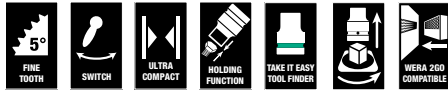

Combines robustness, slim design, and little weight

8006 SC 1 Zyklop Hybrid Ratchet Set, 1/2" drive, metric



13-piece set; in a surface-preserving, compact and extremely robust textile box; low volume and weight for simplified mobility

1 Zyklop Hybrid Ratchet with 1/2" drive, 10 Zyklop sockets with holding function, 1 Zyklop Hybrid Extension with release pin, 1 Zyklop extension (long with free-turning sleeve)

| | | |
|---|-------------|---|
|  | | |
| 05004090001 | | |
|  | 8006 C | 1 x 1/2"x281,0 |
| | 8797 C | 1 x 271,0 |
|  | 8794 LC | 1 x 1/2"x250,0 |
|  | 8790 HMC HF | 1 x 10,0x37,0; 1 x 11,0x37,0; 1 x 12,0x37,0; 1 x 13,0x37,0; 1 x 14,0x37,0; 1 x 15,0x37,0; 1 x 16,0x37,0; 1 x 17,0x37,0; 1 x 18,0x37,0; 1 x 19,0x37,0 |



Zyklop Hybrid Set



Application: Ratchet function for 1/2" square sockets and 1/2" adaptors with square drive, equipped with ball lock

Design: Fine-tooth mechanism with 72 teeth for a return angle of only 5°; switch lever for convenient change of direction; secure socket locking function

Handle: Multi-component Kraftform handle for optimum pressure, impact and tensile loads, handle end designed for connection of Zyklop Hybrid extension 8797 C

| | | |
|---|--------|----------------|
|  | | |
| 05004095001 | | |
|  | 8006 C | 1 x 1/2"x281,0 |
| | 8797 C | 1 x 271,0 |





Tip



TAKE IT EASY
TOOL FINDER

“Take it easy”



“Take it easy” tool finder system – with profile and size colour-coding for quick and easy tool selection. Colour-coded system for hexagon drive screws (L-Keys, Zyklop bit sockets), external hex drive screws and nuts (Joker wrenches, Zyklop sockets and Zyklop bit sockets with holding function), and TORX® drive screws (L-Keys, Zyklop bit sockets).



Secure hold and easy removal



The all new smooth turning mechanism guarantees both secure and rattle-free storage, yet allows easy removal of the tool.



HOLDING
FUNCTION

Sockets with retaining function for hexagon headed bolts, screws and nuts



The clamping of the screw is achieved by two flexible locking balls and a robust, permanently elastic, heat-shrunk tubing. The tubing is effectively protected against mechanical wear and tear by a steel ring. The holding function is especially helpful in confined, hard-to-reach spaces, where there is no room for a second hand to secure the screw.

The Zyklop Hybrid Ratchet, 1/2"

Combines robustness, slim design, and little weight





8006 C Zyklop Hybrid Ratchet with switch lever and 1/2" drive



Application: 1/2" square sockets as well as for 1/2" adaptors with square drive, with ball locking device

Design: Fine-tooth mechanism with 72 teeth for a return angle of only 5°; switch lever for convenient change of direction; secure socket locking function

Handle: Multi-component Kraffform handle for optimum pressure and tensile loads, handle end designed for connection of Zyklop Hybrid extension

| | | | | |
|---|---|---|---|---|
|  | | | | |
| |  |  |  |  |
| | mm | mm | mm | mm |
| 05003780001 | 1/2" | 281,0 | 34 | 37 |



8797 C Zyklop Hybrid extension



Application: Extension for use with Wera Zyklop Hybrid 8006 C to increase torque transfer

Design: Tough, tempered Cr-Mo steel

Handle: Multi-component Kraffform handle for optimum pressure and tensile loads; with extension release pin

| | | |
|-------------|---|---|
| |  |  |
| | mm | mm |
| 05003781001 | 134,0 | 137 |

Unlocking pin



Application: For unlocking the connection between the Koloss Ratchet 8002 C and the Koloss Extension 8780 C as well as the connection between Zyklop Hybrid Ratchet 8006 C and the Zyklop Hybrid Extension 8797 C

Design: Zinc die casting

| | |
|-------------|--|
| |  |
| | mm |
| 05136400001 | 40,5 |



The Zyklop Metal Ratchets Push, 1/2"

With push-through square

8100 SC 7 Zyklop Metal Ratchet Set with push-through square, 1/2" drive, metric

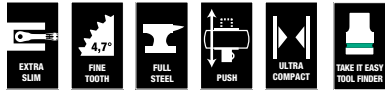

28-piece set; in a surface-preserving, compact and extremely robust textile box; low volume and weight for simplified mobility

1 Zyklop Metal Ratchet with push-through square and 1/2" drive, 10 Zyklop sockets, 1 Zyklop extension (long) with free-turning sleeve, 1 wobble extension, 1 adaptor with quick-release chuck, 14 bits

| | | |
|-------------|---------------|--|
| 05004077001 | | |
| ○ | 8003 C | 1 x 1/2"x281,0 |
| ● | 8790 HMC | 1 x 10,0x37,0; 1 x 11,0x37,0; 1 x 12,0x37,0; 1 x 13,0x37,0; 1 x 14,0x37,0; 1 x 15,0x37,0; 1 x 16,0x37,0; 1 x 17,0x37,0; 1 x 18,0x37,0; 1 x 19,0x37,0 |
| ○ | 8794 LC | 1 x 1/2"x250,0 |
| ○ | 8794 C | 1 x 1/2"x52,0 |
| ○ | 8784 C2 | 1 x 5/16"x1/2"x50,0 |
| + | 851/2 Z PH | 1 x PH 2x32; 1 x PH 3x32 |
| + | 867/2 Z TORX® | 1 x TX 20x35; 1 x TX 25x35; 1 x TX 27x35; 1 x TX 30x35; 1 x TX 40x35; 1 x TX 45x35; 1 x TX 50x35; 1 x TX 55x35 |
| ○ | 840/2 Z | 1 x 5x30; 1 x 6x30; 1 x 8x30; 1 x 10x30 |

8100 SC 10 Zyklop Metal Ratchet Set with push-through square, 1/2" drive, imperial

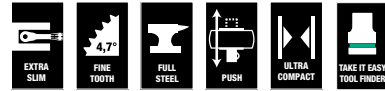

28-piece set; in a surface-preserving, compact and extremely robust textile box; low volume and weight for simplified mobility

1 Zyklop Metal Ratchet with push-through square and 1/2" drive, 10 Zyklop sockets, 1 Zyklop extension (long) with free-turning sleeve, 1 wobble extension, 1 adaptor with quick-release chuck, 14 bits

| | | |
|-------------|---------------|--|
| 05004080001 | | |
| ○ | 8003 C | 1 x 1/2"x281,0 |
| ● | 8790 HMC | 1 x 3/8"x37,0; 1 x 7/16"x37,0; 1 x 1/2"x37,0; 1 x 9/16"x37,0; 1 x 19/32"x37,0; 1 x 5/8"x37,0; 1 x 11/16"x37,0; 1 x 3/4"x37,0; 1 x 25/32"x37,0; 1 x 13/16"x37,0 |
| ○ | 8794 LC | 1 x 1/2"x250,0 |
| ○ | 8794 C | 1 x 1/2"x52,0 |
| ○ | 8784 C2 | 1 x 5/16"x1/2"x50,0 |
| + | 851/2 Z PH | 1 x PH 2x32; 1 x PH 3x32 |
| + | 867/2 Z TORX® | 1 x TX 20x35; 1 x TX 25x35; 1 x TX 27x35; 1 x TX 30x35; 1 x TX 40x35; 1 x TX 45x35; 1 x TX 50x35; 1 x TX 55x35 |
| ○ | 840/2 Z | 1 x 7/32"x30; 1 x 1/4"x30; 1 x 5/16"x30; 1 x 3/8"x30 |

8003 C Zyklop Metal Ratchet with push-through square and 1/2" drive



Application: 1/2" square sockets as well as for 1/2" adaptors with square drive, with ball locking device

Design: Forged, full metal ratchet (chrome-molybdenum) that is extremely robust with a long service life; slim design to enable work in very confined spaces; the dual-ratchet-teeth design means that a 76 fine-toothing division can be achieved from the 38 robust teeth with a return angle of only 4.7°; simple direction change with the undetachable push-through square and very secure socket lock mechanism

| | | | | |
|-------------|------|-------|----|----|
| | | | | |
| | mm | mm | mm | mm |
| 05004063001 | 1/2" | 281,0 | 36 | 37 |

Tip

The Zyklop Metal Ratchets Push



Forged, full metal ratchet (chrome-molybdenum) that is extremely robust with a long service life; slim design to enable work in very confined spaces.

Textile boxes



The textile boxes offer dramatically improved portability, and are space-saving to boot!

This means you can now carry the same collection of tools, in a much more compact and comfortable package. The hassle of running back and forth for the right tools has now become a thing of the past. And the much lower weight of a set makes carrying more convenient than ever before. The textile box including the tool will even survive a fall undamaged. And: it leaves absolutely no signs of scratches on sensitive surfaces.



"Take it easy"



"Take it easy" tool finder system – with profile and size colour-coding for quick and easy tool selection. Colour-coded system for hexagon drive screws (L-Keys, Zyklop bit sockets), external hex drive screws and nuts (Joker wrenches, Zyklop sockets and Zyklop bit sockets with holding function), and TORX® drive screws (L-Keys, Zyklop bit sockets).

The Zyklop Metal Ratchets Switch, 1/2"

With switch lever

8100 SC 8 Zyklop Metal Ratchet Set with switch lever, 1/2" drive, metric



28-piece set; in a surface-preserving, compact and extremely robust textile box; low volume and weight for simplified mobility

1 Zyklop Metal Ratchet with switch lever and 1/2" drive, 10 Zyklop sockets, 1 Zyklop extension (long) with free-turning sleeve, 1 wobble extension, 1 adaptor with quick-release chuck, 14 bits

| | |
|-------------|---|
| 05004078001 | |
| ○ | 8004 C 1 x 1/2"x281,0 |
| ● | 8790 HMC 1 x 10,0x37,0; 1 x 11,0x37,0; 1 x 12,0x37,0; 1 x 13,0x37,0; 1 x 14,0x37,0; 1 x 15,0x37,0; 1 x 16,0x37,0; 1 x 17,0x37,0; 1 x 18,0x37,0; 1 x 19,0x37,0 |
| ⊗ | 8794 LC 1 x 1/2"x250,0 |
| ⊗ | 8794 C 1 x 1/2"x52,0 |
| ⊗ | 8784 C2 1 x 5/16"x1/2"x50,0 |
| + | 851/2 Z PH 1 x PH 2x32; 1 x PH 3x32 |
| ⊗ | 867/2 Z TORX® 1 x TX 20x35; 1 x TX 25x35; 1 x TX 27x35; 1 x TX 30x35; 1 x TX 40x35; 1 x TX 45x35; 1 x TX 50x35; 1 x TX 55x35 |
| ○ | 840/2 Z 1 x 5x30; 1 x 6x30; 1 x 8x30; 1 x 10x30 |

8100 SC 11 Zyklop Metal Ratchet Set with switch lever, 1/2" drive, imperial

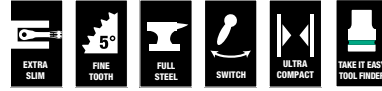

28-piece set; in a surface-preserving, compact and extremely robust textile box; low volume and weight for simplified mobility

1 Zyklop Metal Ratchet with switch lever and 1/2" drive, 10 Zyklop sockets, 1 Zyklop extension (long) with free-turning sleeve, 1 wobble extension, 1 adaptor with quick-release chuck, 14 bits

| | |
|-------------|---|
| 05004081001 | |
| ○ | 8004 C 1 x 1/2"x281,0 |
| ● | 8790 HMC 1 x 3/8"x37,0; 1 x 7/16"x37,0; 1 x 1/2"x37,0; 1 x 9/16"x37,0; 1 x 19/32"x37,0; 1 x 5/8"x37,0; 1 x 11/16"x37,0; 1 x 3/4"x37,0; 1 x 25/32"x37,0; 1 x 13/16"x37,0 |
| ⊗ | 8794 LC 1 x 1/2"x250,0 |
| ⊗ | 8794 C 1 x 1/2"x52,0 |
| ⊗ | 8784 C2 1 x 5/16"x1/2"x50,0 |
| + | 851/2 Z PH 1 x PH 2x32; 1 x PH 3x32 |
| ⊗ | 867/2 Z TORX® 1 x TX 20x35; 1 x TX 25x35; 1 x TX 27x35; 1 x TX 30x35; 1 x TX 40x35; 1 x TX 45x35; 1 x TX 50x35; 1 x TX 55x35 |
| ○ | 840/2 Z 1 x 7/32"x30; 1 x 1/4"x30; 1 x 5/16"x30; 1 x 3/8"x30 |

8004 C Zyklop Metal Ratchet with switch lever and 1/2" drive



Application: 1/2" square sockets as well as for 1/2" adaptors with square drive, with ball locking device

Design: Forged, full metal ratchet (chrome-molybdenum) that is extremely robust with a long service life; slim design to enable work in very confined spaces; fine-tooth mechanism with 72 teeth for a return angle of only 5°; switch lever for convenient change of direction; secure socket locking function

| | | | | |
|-------------|------|-------|----|----|
| | | | | |
| | | mm | mm | mm |
| 05004064001 | 1/2" | 281,0 | 34 | 37 |

Tip

The Zyklop Metal Ratchets Switch



Extremely slim. Long leverage. Very robust without any torque limitation. Forged, full metal ratchet out of chrome molybdenum.

Textile boxes



The textile boxes offer dramatically improved portability, and are space-saving to boot!

This means you can now carry the same collection of tools, in a much more compact and comfortable package. The hassle of running back and forth for the right tools has now become a thing of the past. And the much lower weight of a set makes carrying more convenient than ever before. The textile box including the tool will even survive a fall undamaged. And: it leaves absolutely no signs of scratches on sensitive surfaces.



“Take it easy”



“Take it easy” tool finder system – with profile and size colour-coding for quick and easy tool selection. Colour-coded system for hexagon drive screws (L-Keys, Zyklop bit sockets), external hex drive screws and nuts (Joker wrenches, Zyklop sockets and Zyklop bit sockets with holding function), and TORX® drive screws (L-Keys, Zyklop bit sockets).

Zyklop Accessories, 1/2"

With amazing product benefits

HMC Zyklop socket with 1/2" drive



Application: Hexagon headed bolts, screws and nuts

Design: Manual and (non-impact) machine applications, ball intercept ring, knurls at base for precision handling in manual operations, chrome vanadium, brushed chrome-plated finish. Colour coding to enable the desired bit socket to be easily located

| | mm | mm | mm | mm | mm | mm |
|-------------|---------|------|------|------|------|----|
| 05003601001 | 10,0 | 37,0 | 15,5 | 24,0 | 17,0 | |
| 05003602001 | 11,0 | 37,0 | 16,5 | 24,0 | 17,0 | |
| 05003603001 | 12,0 | 37,0 | 17,5 | 24,0 | 17,0 | |
| 05003604001 | 13,0 | 37,0 | 19,0 | 24,0 | 17,0 | |
| 05003605001 | 14,0 | 37,0 | 20,0 | 24,0 | 17,0 | |
| 05003606001 | 15,0 | 37,0 | 21,0 | 24,0 | 17,0 | |
| 05003607001 | 16,0 | 37,0 | 22,5 | 24,0 | 17,0 | |
| 05003608001 | 17,0 | 37,0 | 24,0 | 26,0 | 17,0 | |
| 05003609001 | 18,0 | 37,0 | 25,0 | 26,0 | 17,0 | |
| 05003610001 | 19,0 | 37,0 | 26,5 | 26,0 | 20,0 | |
| 05003611001 | 20,0 | 37,0 | 28,0 | 26,0 | 20,0 | |
| 05003612001 | 21,0 | 37,0 | 29,0 | 26,0 | 20,0 | |
| 05003613001 | 22,0 | 37,0 | 30,5 | 26,0 | 20,0 | |
| 05003614001 | 24,0 | 37,0 | 33,0 | 28,0 | 20,0 | |
| 05003615001 | 27,0 | 40,0 | 36,5 | 32,0 | 23,0 | |
| 05003616001 | 30,0 | 42,0 | 40,0 | 34,0 | 25,0 | |
| 05003617001 | 32,0 | 42,0 | 42,0 | 36,0 | 25,0 | |
| 05003618001 | 3/8" | 37,0 | 15,5 | 24,0 | 17,0 | |
| 05003619001 | 7/16" | 37,0 | 16,5 | 24,0 | 17,0 | |
| 05003620001 | 1/2" | 37,0 | 19,0 | 24,0 | 17,0 | |
| 05003621001 | 9/16" | 37,0 | 20,0 | 24,0 | 17,0 | |
| 05003622001 | 19/32" | 37,0 | 21,0 | 24,0 | 17,0 | |
| 05003623001 | 5/8" | 37,0 | 22,5 | 24,0 | 17,0 | |
| 05003624001 | 11/16" | 37,0 | 25,5 | 26,0 | 17,0 | |
| 05003625001 | 3/4" | 37,0 | 26,5 | 26,0 | 20,0 | |
| 05003626001 | 25/32" | 37,0 | 28,0 | 26,0 | 20,0 | |
| 05003627001 | 13/16" | 37,0 | 29,0 | 26,0 | 20,0 | |
| 05003628001 | 7/8" | 37,0 | 30,5 | 26,0 | 20,0 | |
| 05003629001 | 15/16" | 37,0 | 33,0 | 28,0 | 20,0 | |
| 05003630001 | 31/32" | 37,0 | 33,0 | 28,0 | 20,0 | |
| 05003631001 | 1" | 40,0 | 36,5 | 32,0 | 23,0 | |
| 05003632001 | 1 1/16" | 40,0 | 36,5 | 32,0 | 23,0 | |
| 05003633001 | 1 1/8" | 40,0 | 40,0 | 34,0 | 23,0 | |
| 05003634001 | 1 3/16" | 42,0 | 40,0 | 34,0 | 25,0 | |
| 05003635001 | 1 1/4" | 42,0 | 42,0 | 36,0 | 25,0 | |

8790 HMC HF Zyklop socket with 1/2" drive with holding function



Application: Hexagon headed bolts, screws and nuts

Design: Manual and (non-impact) machine applications, ball intercept ring, knurls at base for precision handling in manual operations, with holding function, chrome vanadium, brushed chrome-plated finish. Colour coding to enable the desired bit socket to be easily located

| | mm | mm | mm | mm | mm | mm |
|-------------|------|------|------|------|------|----|
| 05003730001 | 10,0 | 37,0 | 17,8 | 23,5 | 10,4 | |
| 05003731001 | 11,0 | 37,0 | 18,8 | 23,5 | 10,4 | |
| 05003732001 | 12,0 | 37,0 | 20,4 | 23,5 | 11,4 | |
| 05003733001 | 13,0 | 37,0 | 21,4 | 23,5 | 11,4 | |
| 05003734001 | 14,0 | 37,0 | 22,6 | 23,5 | 11,4 | |
| 05003735001 | 15,0 | 37,0 | 23,6 | 23,5 | 12,0 | |
| 05003736001 | 16,0 | 37,0 | 25,0 | 23,5 | 12,0 | |
| 05003737001 | 17,0 | 37,0 | 26,8 | 23,5 | 12,5 | |
| 05003738001 | 18,0 | 37,0 | 28,0 | 23,5 | 12,5 | |
| 05003739001 | 19,0 | 37,0 | 29,2 | 23,5 | 14,0 | |

8790 HF 1 Zyklop socket set with holding function



10-piece set; in a surface-preserving, compact and extremely robust textile box; low volume and weight for simplified mobility

10 Zyklop sockets with 1/2" drive with holding function

| | | |
|-------------|-------------|--|
| 05004203001 | 8790 HMC HF | 1 x 10,0x37,0; 1 x 11,0x37,0; 1 x 12,0x37,0; 1 x 13,0x37,0; 1 x 14,0x37,0; 1 x 15,0x37,0; 1 x 16,0x37,0; 1 x 17,0x37,0; 1 x 18,0x37,0; 1 x 19,0x37,0 |
|-------------|-------------|--|

Nut Extractor



Tool made out of synthetic plastic material (TPE) for the simple removal of nuts from sockets with holding function.

| | | |
|-------------|------|------|
| | | |
| | mm | mm |
| 05050005001 | 14,0 | 43,0 |

Tip



Sockets with retaining function for hexagon headed bolts, screws and nuts



The clamping of the screw is achieved by two flexible locking balls and a robust, permanently elastic, heat-shrunk tubing. The tubing is effectively protected against mechanical wear and tear by a steel ring. The holding function is especially helpful in confined, hard-to-reach spaces, where there is no room for a second hand to secure the screw.



Secure hold and easy removal



The all new smooth turning mechanism of the Zyklop HF Socket sets guarantees both secure and rattle-free storage, yet allows easy removal of the tool.

Nut extractor tool



This tool enables hexagon nuts to be easily removed from sockets with holding function.



Zyklop Accessories, 1/2"

With amazing product benefits

8767 C HF TORX® Zyklop bit socket with 1/2" drive with holding function



Application: TORX® socket screws

Design: Manual and (non-impact) machine applications, ball intercept ring, knurls at base for precision handling in manual operations, chrome vanadium, brushed chrome-plated finish, holding function for TORX® screws made according to Acument Intellectual Properties specifications. Take it easy tool finder: Colour coding to enable the desired bit socket to be easily located

| | | | | mm | mm | mm | mm |
|-------------|--|--|--|-------|------|------|-------|
| 05003830001 | | | | 60,0 | 16,4 | 23,5 | 21,5 |
| 05003850001 | | | | 140,0 | 16,4 | 23,5 | 101,5 |
| 05003831001 | | | | 60,0 | 16,4 | 23,5 | 21,5 |
| 05003851001 | | | | 140,0 | 16,4 | 23,5 | 101,5 |
| 05003832001 | | | | 60,0 | 16,4 | 23,5 | 21,5 |
| 05003852001 | | | | 140,0 | 16,4 | 23,5 | 101,5 |
| 05003833001 | | | | 60,0 | 16,4 | 23,5 | 21,5 |
| 05003853001 | | | | 140,0 | 16,4 | 23,5 | 101,5 |
| 05003834001 | | | | 60,0 | 16,4 | 23,5 | 21,5 |
| 05003854001 | | | | 140,0 | 16,4 | 23,5 | 101,5 |
| 05003835001 | | | | 60,0 | 16,4 | 23,5 | 21,5 |
| 05003855001 | | | | 140,0 | 16,4 | 23,5 | 101,5 |
| 05003836001 | | | | 60,0 | 21,4 | 23,5 | 21,5 |
| 05003856001 | | | | 140,0 | 21,4 | 23,5 | 101,5 |
| 05003837001 | | | | 60,0 | 21,4 | 23,5 | 21,5 |
| 05003857001 | | | | 140,0 | 21,4 | 23,5 | 101,5 |
| 05003838001 | | | | 60,0 | 21,4 | 23,5 | 21,5 |
| 05003858001 | | | | 140,0 | 21,4 | 23,5 | 101,5 |

8767 C TORX® HF 1 Zyklop bit socket set with 1/2" drive, with holding function



9-piece set; in a surface-preserving, compact and extremely robust textile box; low volume and weight for simplified mobility

9 Zyklop bit sockets for TORX® screws, with 1/2" drive, with holding function

| 05004202001 | | |
|-------------|------------------|--|
| | 8767 C HF | 1 x TX 20x60; 1 x TX 25x60; 1 x TX 27x60; 1 x TX 30x60; 1 x TX 40x60; 1 x TX 45x60; 1 x TX 50x60; 1 x TX 55x60; 1 x TX 60x60 |

8767 C TORX® HF 2 Zyklop bit socket set with 1/2" drive, with holding function



6-piece set; in a surface-preserving, compact and extremely robust textile box; low volume and weight for simplified mobility

6 Zyklop bit sockets, 140 mm long, for TORX® screws, with 1/2" drive, with holding function

| 05004211001 | | |
|-------------|------------------|--|
| | 8767 C HF | 1 x TX 20x140; 1 x TX 25x140; 1 x TX 27x140; 1 x TX 30x140; 1 x TX 40x140; 1 x TX 45x140 |

8767 C TORX® HF 3 Zyklop bit socket set with 1/2" drive, with holding function



9-piece set; in a surface-preserving, compact and extremely robust textile box; low volume and weight for simplified mobility

9 Zyklop bit sockets, 140 mm long, for TORX® screws, with 1/2" drive, with holding function

| | |
|-------------|--|
| | |
| 05004212001 | |
| | 8767 C HF 1 x TX 20x140; 1 x TX 25x140; 1 x TX 27x140; 1 x TX 30x140; 1 x TX 40x140; 1 x TX 45x140; 1 x TX 50x140; 1 x TX 55x140; 1 x TX 60x140 |

8740 C HF 1 Zyklop bit socket set with 1/2" drive with holding function



9-piece set; in a surface-preserving, compact and extremely robust textile box; low volume and weight for simplified mobility

9 Zyklop bit sockets for hexagon socket screws, with 1/2" drive, with holding function

| | |
|-------------|---|
| | |
| 05004201001 | |
| | 8740 C HF 1 x 4,0x60,0; 1 x 5,0x60,0; 1 x 6,0x60,0; 1 x 7,0x60,0; 1 x 8,0x60,0; 1 x 10,0x60,0; 1 x 12,0x60,0; 1 x 14,0x60,0; 1 x 17,0x60,0 |

Tip



Bit sockets with holding function for TORX® screws



The HF tools developed by Wera are ideal because they feature an optimised geometry of the original TORX® profile. The wedging forces resulting from the surface pressure between the drive tip and the screw profile mean that TORX® screws made according to Acument Intellectual Properties specifications are securely held on the tool!

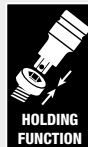

Bit sockets with retaining function for hexagon socket screws



The clamping of the screw is achieved by a flexible locking ball. The holding function is especially helpful in confined, hard-to-reach spaces, where there is no room for a second hand to secure the screw.



Secure hold and easy removal



The all new smooth turning mechanism of the Zyklop HF Socket sets guarantees both secure and rattle-free storage, yet allows easy removal of the tool.

Zyklop Accessories, 1/2"



With amazing product benefits

8740 C HF 2 Zyklop bit socket set with 1/2" drive, with holding function



9-piece set; in a surface-preserving, compact and extremely robust textile box; low volume and weight for simplified mobility

9 Zyklop bit sockets, 140 mm long, for hexagon socket screws, with 1/2" drive, with holding function



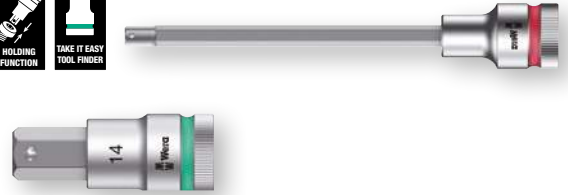
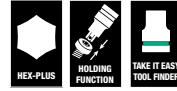

| | |
|---|---|
|  | |
| 05004210001 | |
|  | 8740 C HF 1 x 4,0x140,0; 1 x 5,0x140,0; 1 x 6,0x140,0; 1 x 7,0x140,0; 1 x 8,0x140,0; 1 x 10,0x140,0 |

8740 C HF Zyklop bit socket with 1/2" drive with holding function



Application: Hexagon socket screws

Design: Manual and (non-impact) machine applications, ball intercept ring, knurls at base for precision handling in manual operations, chrome vanadium, brushed chrome-plated finish, holding function for hexagon socket screws. Colour coding to enable the desired bit socket to be easily located

| |  |  |  |  |  |
|-------------|---|---|---|---|---|
| | mm | mm | mm | mm | mm |
| 05003820001 | 4,0 | 60,0 | 14,0 | 21,5 | 21,5 |
| 05003840001 | 4,0 | 140,0 | 14,0 | 21,5 | 101,5 |
| 05003821001 | 5,0 | 60,0 | 14,0 | 21,5 | 21,5 |
| 05003841001 | 5,0 | 140,0 | 14,0 | 21,5 | 101,5 |
| 05003822001 | 6,0 | 60,0 | 14,0 | 21,5 | 21,5 |
| 05003842001 | 6,0 | 140,0 | 14,0 | 21,5 | 101,5 |
| 05003823001 | 7,0 | 60,0 | 14,0 | 23,5 | 21,5 |
| 05003843001 | 7,0 | 140,0 | 14,0 | 23,5 | 101,5 |
| 05003824001 | 8,0 | 60,0 | 16,0 | 23,5 | 21,5 |
| 05003844001 | 8,0 | 140,0 | 16,0 | 23,5 | 101,5 |
| 05003825001 | 10,0 | 60,0 | 16,0 | 23,5 | 21,5 |
| 05003845001 | 10,0 | 140,0 | 16,0 | 23,5 | 101,5 |
| 05003826001 | 12,0 | 60,0 | 21,0 | 23,5 | 23,0 |
| 05003827001 | 14,0 | 60,0 | 22,0 | 23,5 | 23,0 |
| 05003828001 | 17,0 | 60,0 | 24,5 | 25,5 | 23,0 |
| 05003829001 | 19,0 | 60,0 | 26,5 | 27,5 | 23,0 |



Zyklop Accessories, 1/2"

With amazing product benefits

8796 SC Zyklop „flexible-lock“ extension with free-turning sleeve, short, 1/2"



Application: 1/2" square drive sockets with ball lock

Design: Flexible lock system either for permanent interlocking or fast change of accessories, free-turning sleeve for rapid tightening or loosening of screws and nuts, chrome vanadium, brushed chrome-plated finish

| | | |
|-------------|------|-------|
| | | mm |
| 05003642001 | 1/2" | 125,0 |

8794 SC Zyklop extension with free-turning sleeve, short, 1/2"



Application: 1/2" square drive sockets with ball lock

Design: Easy-to-grip free-turning sleeve for rapid tightening or loosening of screws and nuts, chrome vanadium, brushed chrome-plated finish

| | | |
|-------------|------|-------|
| | | mm |
| 05003637001 | 1/2" | 125,0 |

8796 LC Zyklop "flexible-lock" extension with free-turning sleeve, long, 1/2"



Application: 1/2" square drive sockets with ball lock

Design: Flexible lock system either for permanent interlocking or fast change of accessories, free-turning sleeve for rapid tightening or loosening of screws and nuts, chrome vanadium, brushed chrome-plated finish

| | | |
|-------------|------|-------|
| | | mm |
| 05003643001 | 1/2" | 250,0 |

8794 LC Zyklop extension with free-turning sleeve, long, 1/2"



Application: 1/2" square drive sockets with ball lock

Design: Easy-to-grip free-turning sleeve for rapid tightening or loosening of screws and nuts, chrome vanadium, brushed chrome-plated finish

| | | |
|-------------|------|-------|
| | | mm |
| 05003638001 | 1/2" | 250,0 |

8789 C Zyklop sliding T-handle, 1/2"



Application: 1/2" square drive sockets with ball lock

Design: Sliding drive, chrome vanadium, brushed chrome-plated finish

| | | |
|-------------|------|---------|
| | | ↓ mm |
| 05003636001 | 1/2" | 250,0 |

8784 C2 Zyklop Bit adaptor, 1/2", 5/16"



Application: Suitable for 5/16" hex bits as per DIN ISO 1173-C 8 and Wera series 2

Design: Quick-release chuck for fast bit changes, chromium vanadium

| | | | |
|-------------|-------|------|---------|
| | | | ↓ mm |
| 05003641001 | 5/16" | 1/2" | 50,0 |

8795 C Zyklop universal joint, 1/2"



Application: 1/2" square drive sockets with ball lock

Design: Chrome vanadium/chrome molybdenum, brushed chrome-plated finish

| | | |
|-------------|------|---------|
| | | ↓ mm |
| 05003640001 | 1/2" | 69,0 |

8794 C Zyklop wobble extension, 1/2"



Application: 1/2" square drive sockets with ball lock

Design: Swivels through 15°, chrome vanadium, brushed chrome-plated finish

| | | |
|-------------|------|---------|
| | | ↓ mm |
| 05003639001 | 1/2" | 52,0 |

The Koloss

Obviously, many users also apply their ratchet as a hammer. This often ruins the ratchet and is dangerous to boot.

That is why we developed the heavy-duty Koloss ratchet whose mechanism is extremely robust, and nearly impossible to destroy through impact.

The Koloss is so robust that it can even be used safely with its extension element.



Non-removable sealed and hardened square drive for tough jobs.



Changing the ratchet direction using a hardened push-through square drive ensures great resilience, since there is no susceptible switching mechanism that could be damaged by hammer blows. This is far more robust than a forward/reverse switch.



Tubular shaft minimises impact vibrations.

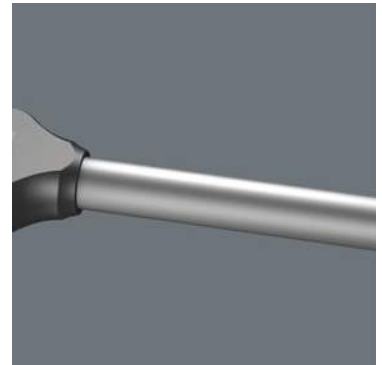

Dry-fined hammer face: used with rubber pad attachments to protect materials and surfaces.



The drop-forged hammer head is permanently pinned to the shaft in a form-fit joint. This guarantees an almost non-detachable positioning of the hammer head on the handle.



Dual ratchet teeth: gives the robust 30 saw teeth the precision engineering effect of 60 fine teeth with a 6° return angle.



Newly developed, multi-component Kraftform handle that satisfies both the hammer and ratchet application requirements.



Sockets and accessories can simply and quickly be attached.



The degree of torque applied can be increased by using the Wera extension Koloss 8002 C.

Koloss

This ratchet is a real hit! And that is for sure!

8002 C Koloss All Inclusive Set with 1/2" drive



Application: Ratchet function for 1/2" square sockets and 1/2" adaptors with square drive, equipped with ball lock, hammer function e.g. to align work pieces

Design: Push-through square drive for forward and reverse operation, fine-tooth ratchet mechanism, small return angle of 6°, can transfer at least 600 Nm of torque, tubular shaft to minimise impact vibrations, drop-forged hammer head, positively pinned, ground striking face

Handle: Multi-component Kraftform handle for optimum pressure, impact and tensile loads, handle end designed for connection of Koloss extension 8780 C and Koloss centering pin 8781 C

| | | |
|-------------|----------|-------------------|
| 05133862001 | | |
| | 8002 C | 1 x 1/2"x341,0 |
| | 8782 C | 1 x 2x50,0 |
| | 8780 C | 1 x 341,0x137 |
| | 8000 E | 1 x Unlocking pin |
| | 8000 HLF | 1 x Holster |

8002 C Koloss 1/2" with 1/2" drive



Application: Ratchet function for 1/2" square sockets and 1/2" adaptors with square drive, equipped with ball lock, hammer function e.g. to align work pieces

Design: Push-through square drive for forward and reverse operation, fine-tooth ratchet mechanism, small return angle of 6°, can transfer at least 600 Nm of torque, tubular shaft to minimise impact vibrations, drop-forged hammer head, positively pinned, ground striking face

Handle: Multi-component Kraftform handle for optimum pressure, impact and tensile loads, handle end designed for connection of Koloss extension 8780 C and Koloss centering pin 8781 C

| | | |
|-------------|----------|----------------|
| 05003692001 | | |
| | 8002 C | 1 x 1/2"x341,0 |
| | 8782 C | 1 x 2x50,0 |
| | 8000 HLF | 1 x Holster |

8780 C Koloss extension



Application: Extension for use with Wera Koloss 8002 C to increase torque transfer

Design: Tough, tempered Cr-Mo steel

Handle: Multi-component Kraftform handle for optimum pressure, impact and tensile loads, laser-engraved safety instructions for permanent recognition



| | | |
|-------------|-------|-----|
| | ⌀ | ⌀ |
| | mm | mm |
| 05003695001 | 341,0 | 137 |

8781 C Koloss centring pin



Application: Centering pin for use with Wera Koloss 8002 C to align lugs or drill holes

Design: Tapered pin out of tough, tempered Cr-Mo steel

| |  mm |  mm |
|-------------|---|---|
| 05003696001 | 50 | 135,0 |

8782 C Koloss pad set



Application: Protective attachment for striking faces for use with Wera Koloss 8002 C to protect materials and surfaces

Design: Flexible, thermoplastic elastomer material for lasting elasticity and maximum protection

| | # |  mm |
|-------------|---|---|
| 05003697001 | 2 | 50,0 |

Unlocking pin



Application: For unlocking the connection between the Koloss Ratchet 8002 C and the Koloss Extension 8780 C as well as the connection between Zyklop Hybrid Ratchet 8006 C and the Zyklop Hybrid Extension 8797 C

Design: Zinc die casting

| |  mm |
|-------------|---|
| 05136400001 | 40,5 |

Tip

Dry-fined hammer face



Dry-fined hammer face: used with rubber pad attachments to protect materials and surfaces.

Why do the dual ratchet teeth provide particular robustness?



Dual ratchet teeth: gives the robust 30 saw teeth the precision engineering effect of 60 fine teeth with a 6° return angle.

Who is the Koloss suitable for?



Basically anyone who would like to work with a 1/2" ratchet. Typical fields of application are mechanical engineering, boatbuilding, mining, aircraft construction, bridge building, commercial vehicle construction and maintenance, railway and road construction and maintenance, industrial plant and equipment construction, high-bay warehouse construction, petroleum industry and many more.

Zyklop Mini

Combines elegant design with incredible resilience. Suitable for rapid fastening even in confined working situations. The Wera Zyklop Mini is applied whenever fastening with a power tool or conventional tools is impossible due to insufficient space.

The Zyklop Mini 1 for the direct attachment of bits; the Zyklop Mini 2 for the direct attachment of the special Wera Zyklop sockets.



The fine tooth mechanism, with its 60 teeth, allows a small return angle of only 6° – ideal for precision work.



Thumbwheel enables rapid screw-driving, even when there isn't sufficient room for ratcheting use.



Simple switching between left/right operations.



Its slim design makes it ideal for all particularly confined working situations.

Zyklop Mini

For confined spaces

Bit-Check 30 Zyklop Mini 1



28 bits, 1 Rapidaptor bit holder, 1 adaptor 870/1 (1/4" hexagon to 1/4" square), 1 Wera Bit Ratchet, drop-forged full steel design, suitable for 1/4" hex bits as per DIN ISO 1173-C 6,3 and E 6,3 and Wera series 1 and 4

| | | |
|-------------|------------------|--|
| 05073640001 | | |
| | 8001 A | 1 x 1/4"x87,0 |
| ⊙⊙ | 870/1 | 1 x 1/4"x25 |
| ⊙⊙ | 889/4/1 K | 1 x 1/4"x50 |
| ⊕ | 851/1 TZ PH | 2 x PH 1x25; 3 x PH 2x25; 1 x PH 3x25 |
| ⊕ | 855/1 TH PZ | 1 x PZ 1x25; 3 x PZ 2x25; 1 x PZ 3x25 |
| ⊕ | 867/1 TZ TORX® | 1 x TX 10x25; 1 x TX 15x25; 1 x TX 20x25; 1 x TX 25x25; 1 x TX 30x25; 1 x TX 40x25 |
| ⊕ | 867/1 Z TORX® | 1 x TX 10x25; 1 x TX 15x25; 1 x TX 20x25; 1 x TX 25x25; 1 x TX 30x25 |
| ⊕ | 800/1 TZ | 1 x 1,0x5,5x25 |
| ⊕ | 840/1 Z Hex-Plus | 1 x 3,0x25; 1 x 4,0x25; 1 x 5,0x25; 1 x 6,0x25; 1 x 8,0x25 |

Bit-Check 30 Zyklop Mini 2



28 bits, 1 Rapidaptor bit holder, 1 adaptor 870/1 (1/4" hexagon to 1/4" square), 1 Wera Bit Ratchet, drop-forged full steel design, suitable for 1/4" hex bits as per DIN ISO 1173-C 6,3 and E 6,3 and Wera series 1 and 4

| | | |
|-------------|------------------|--|
| 05346293001 | | |
| | 8001 A | 1 x 1/4"x87,0 |
| ⊙⊙ | 870/1 | 1 x 1/4"x25 |
| ⊙⊙ | 889/4/1 K | 1 x 1/4"x50 |
| ⊕ | 851/1 TZ PH | 2 x PH 1x25; 3 x PH 2x25; 1 x PH 3x25 |
| ⊕ | 867/1 TZ TORX® | 1 x TX 10x25; 1 x TX 15x25; 1 x TX 20x25; 1 x TX 25x25; 1 x TX 30x25; 1 x TX 40x25 |
| ⊕ | 867/1 Z TORX® | 1 x TX 10x25; 1 x TX 15x25; 1 x TX 20x25; 1 x TX 25x25; 1 x TX 30x25 |
| ⊕ | 800/1 TZ | 1 x 1,0x5,5x25 |
| ⊕ | 840/1 Z Hex-Plus | 1 x 3/32"x25; 1 x 1/8"x25; 1 x 5/32"x25; 1 x 3/16"x25; 1 x 1/4"x25 |
| ⊕ | 868/1 Z | 1 x # 1x25; 3 x # 2x25; 1 x # 3x25 |

Kraftform Kompakt Zyklop Mini 2



1 Wera Bit Ratchet Zyklop Mini 1, drop-forged full steel design, suitable for 1/4" hex bits as per DIN ISO 1173-C 6,3 and E 6,3 and Wera series 1 and 4. Can also be used with 1/4" sockets by using the Wera socket adaptor 870/1. 1 Wera Ratchet Zyklop Mini 2, drop-forged full steel design, suitable for for Wera sockets 8790 FA. 9 Wera sockets 8790 FA, 1 socket adaptor 870/1, 14 bits, tough, for universal use

| | |
|-------------|--|
| | |
| 05135918001 | |
| | 8001 A 1 x 1/4"x87,0 |
| | 8005 1 x 107 |
| | 813 1 x 1/4"x78 |
| | 870/1 1 x 1/4"x25 |
| | 851/1 Z PH 1 x PH 1x25; 1 x PH 2x25 |
| | 855/1 Z PZ 1 x PZ 1x25; 1 x PZ 2x25 |
| | 867/1 TORX® 1 x TX 10x25; 1 x TX 15x25; 1 x TX 20x25; 1 x TX 25x25; 1 x TX 30x25; 1 x TX 40x25 |
| | 840/1 Z Hex-Plus 1 x 3,0x25; 1 x 4,0x25; 1 x 5,0x25; 1 x 6,0x25 |
| | 8790 FA 1 x 4,0; 1 x 5,0; 1 x 5,5; 1 x 6,0; 1 x 7,0; 1 x 8,0; 1 x 10,0; 1 x 12,0; 1 x 13,0 |

Tip

Zyklop Mini tool sets



Available in a set with the dependable Wera Bit-Check with socket adaptor and belt clip. Simple fitting and removal of tools. Very robust and a long service life.

Bit-Check as a lever



The Bit-Check itself can be used as a lever.

Zyklop Mini 2



The Zyklop Mini 2 is suitable for the direct attachment of the special Wera Zyklop sockets 8790 FA. These sockets feature a very low height, ideal for confined working spaces.

Zyklop Mini

For confined spaces

Tool-Check PLUS



28 bits, 1 hand holder 813 suitable for the attachment of bits with 1/4" hexagon drive as per DIN ISO 1173-C 6,3 and Wera connection series 1, 1 Rapidaptor bit holder, 1 adaptor 870/1 (1/4" hexagon to 1/4" square), 7 sockets (1/4"); 1 Wera Bit Ratchet, drop-forged full steel design suitable for the attachment of bits with 1/4" hexagon drive as per DIN ISO 1173-C 6,3 and E 6,3 and Wera connection series 1 and 4; the use of 1/4" sockets is also possible with the application of the Wera adaptor 870/1

| | | |
|-------------|------------------|---|
| 05056490001 | | |
| ● | 8001 A | 1 x 1/4"x87,0 |
| ● | 813 | 1 x 1/4"x78 |
| ●○ | 889/4/1 K | 1 x 1/4"x50 |
| ○ | 870/1 | 1 x 1/4"x25 |
| ● | 8790 HMA | 1 x 5,5x23,0; 1 x 6,0x23,0; 1 x 7,0x23,0; 1 x 8,0x23,0; 1 x 10,0x23,0; 1 x 12,0x23,0; 1 x 13,0x23,0 |
| ⊕ | 851/1 TZ PH | 2 x PH 1x25; 3 x PH 2x25; 1 x PH 3x25 |
| ⊕ | 855/1 TH PZ | 1 x PZ 1x25; 3 x PZ 2x25; 1 x PZ 3x25 |
| ⊕ | 867/1 TZ TORX® | 1 x TX 10x25; 1 x TX 15x25; 1 x TX 20x25; 1 x TX 25x25; 1 x TX 30x25; 1 x TX 40x25 |
| ⊕ | 867/1 Z TORX® B0 | 1 x TX 10x25; 1 x TX 15x25; 1 x TX 20x25; 1 x TX 25x25; 1 x TX 30x25 |
| ○ | 840/1 Z Hex-Plus | 1 x 3,0x25; 1 x 4,0x25; 1 x 5,0x25; 1 x 6,0x25; 1 x 8,0x25 |
| ● | 800/1 TZ | 1 x 1,0x5,5x25 |

Tool-Check PLUS Imperial



28 bits, 1 hand holder 813 suitable for the attachment of bits with 1/4" hexagon drive as per DIN ISO 1173-C 6,3 and Wera connection series 1, 1 Rapidaptor bit holder, 1 adaptor 870/1 (1/4" hexagon to 1/4" square), 7 sockets (1/4"); 1 Wera Bit Ratchet, drop-forged full steel design suitable for the attachment of bits with 1/4" hexagon drive as per DIN ISO 1173-C 6,3 and E 6,3 and Wera connection series 1 and 4; the use of 1/4" sockets is also possible with the application of the Wera adaptor 870/1

| | | |
|-------------|------------------|--|
| 05056491001 | | |
| ● | 8001 A | 1 x 1/4"x87,0 |
| ● | 813 | 1 x 1/4"x78 |
| ●○ | 889/4/1 K | 1 x 1/4"x50 |
| ○ | 870/1 | 1 x 1/4"x25 |
| ● | 8790 HMA | 1 x 3/16"x23,0; 1 x 1/4"x23,0; 1 x 5/16"x23,0; 1 x 11/32"x23,0; 1 x 3/8"x23,0; 1 x 7/16"x23,0; 1 x 1/2"x23,0 |
| ⊕ | 851/1 TZ PH | 2 x PH 1x25; 3 x PH 2x25; 1 x PH 3x25 |
| ● | 800/1 TZ | 1 x 1,0x5,5x25 |
| ⊕ | 867/1 TZ TORX® | 1 x TX 10x25; 1 x TX 15x25; 1 x TX 20x25; 1 x TX 25x25; 1 x TX 30x25; 1 x TX 40x25 |
| ⊕ | 867/1 Z TORX® B0 | 1 x TX 10x25; 1 x TX 15x25; 1 x TX 20x25; 1 x TX 25x25; 1 x TX 30x25 |
| ○ | 840/1 Z Hex-Plus | 1 x 3/32"x25; 1 x 1/8"x25; 1 x 5/32"x25; 1 x 3/16"x25; 1 x 5/16"x25 |
| ○ | 868/1 V | 1 x # 1x25; 3 x # 2x25; 1 x # 3x25 |



”To learn more about this product, scan the QR code.“

Tool-Check 1 SB



28 bits; 1 socket adaptor 870/1 (1/4" hexagonal to 1/4" square); 7 manual & power tool sockets; 1 Rapidaptor bit holder; 1 Wera Bit Ratchet, with drop-forged steel design suitable for the fitting of bits with 1/4" hexagonal headed drive as per DIN ISO 1173-C 6,3 and E 6,3, i.e. Wera Series 1 and 4. Can also be used with 1/4" sockets by using the socket adaptor (870/1).

| 05073220001 | |
|---------------|---|
| 8001 A | 1 x 1/4"x87,0 |
| 870/1 | 1 x 1/4"x25 |
| 889/4/1 K | 1 x 1/4"x50 |
| 851/1 TZ PH | 2 x PH 1x25; 3 x PH 2x25; 1 x PH 3x25 |
| 855/1 TH PZ | 1 x PZ 1x25; 3 x PZ 2x25; 1 x PZ 3x25 |
| 867/1 TZ | 1 x TX 10x25; 1 x TX 15x25; 1 x TX 20x25; |
| TORX® | 1 x TX 25x25; 1 x TX 30x25; 1 x TX 40x25 |
| 867/1 Z TORX® | 1 x TX 10x25; 1 x TX 15x25; 1 x TX 20x25; |
| B0 | 1 x TX 25x25; 1 x TX 30x25 |
| 800/1 TZ | 1 x 1,0x5,5x25 |
| 840/1 Z | 1 x 3,0x25; 1 x 4,0x25; 1 x 5,0x25; 1 x 6,0x25; |
| Hex-Plus | 1 x 8,0x25 |
| 8790 HMA | 1 x 5,5x23,0; 1 x 6,0x23,0; 1 x 7,0x23,0; |
| | 1 x 8,0x23,0; 1 x 10,0x23,0; 1 x 12,0x23,0; |
| | 1 x 13,0x23,0 |

Tip

What parts can be connected to the Zyklop Mini 1?



Bits and sockets. Bits can be connected directly. However, a holder can be connected first and then the bit can be attached to this. This then serves as an extension with a free-turning sleeve. An adaptor e.g. Wera 870/1 is needed for sockets – 1/4" hexagonal on a square drive (included in the Bit-Check and with the individual Zyklop Mini 1 in the set).

When is the Zyklop Mini 1 needed?



Particularly when the space is confined and there is not much room for the tool.

Is rapid screwdriving possible with the Zyklop Mini?



High working speeds can be attained with the Zyklop Mini. The thumb wheel is important, enabling more rapid screwdriving, and the Zyklop Mini handle only needs to be used for the final tightening of the screw.



"Take it easy"



"Take it easy" tool finder system – with profile and size colour-coding for quick and easy tool selection. Colour-coded system for hexagon drive screws (L-Keys, Zyklop bit sockets), external hex drive screws and nuts (Joker wrenches, Zyklop sockets and Zyklop bit sockets with holding function), and TORX® drive screws (L-Keys, Zyklop bit sockets).

Zyklop Mini

For confined spaces

Tool-Check Automotive 1



28 bits; 1 870/1 socket adaptor (1/4" hexagonal to 1/4" square); 7 manual & power tool sockets; 1 Rapidaptor bit holder; 1 Wera Bit Ratchet, with drop-forged steel design suitable for the fitting of bits with 1/4" hexagonal headed drive as per DIN ISO 1173-C 6,3 and E 6,3, i.e. Wera Series 1 and 4. Can also be used with 1/4" sockets by using the socket adaptor (870/1).

| | |
|--------------------|---|
| 05200995001 | |
| 8001 A | 1 x 1/4"x87,0 |
| 870/1 | 1 x 1/4"x25 |
| 889/4/1 K | 1 x 1/4"x50 |
| 851/1 TZ PH | 1 x PH 1x25; 1 x PH 2x25; 1 x PH 3x25 |
| 867/1 TZ TORX® | 1 x TX 10x25; 1 x TX 15x25; 1 x TX 20x25; 1 x TX 25x25; 1 x TX 30x25; 1 x TX 40x25 |
| 867/1 Z TORX® B0 | 1 x TX 10x25; 1 x TX 15x25; 1 x TX 20x25; 1 x TX 25x25; 1 x TX 30x25 |
| 800/1 TZ | 1 x 1,0x5,5x25 |
| 840/1 Z Hex-Plus | 1 x 3,0x25; 1 x 4,0x25; 1 x 5,0x25; 1 x 6,0x25; 1 x 8,0x25 |
| 860/1 XZN Vielzahn | 1 x M 4x25; 1 x M 5x25; 1 x M 6x25; 1 x M 8x25 |
| 873/1 Five Lobe | 1 x 20x25; 1 x 25x25; 1 x 27x25; 1 x 30x25 |
| 8790 HMA | 1 x 5,5x23,0; 1 x 6,0x23,0; 1 x 7,0x23,0; 1 x 8,0x23,0; 1 x 10,0x23,0; 1 x 12,0x23,0; 1 x 13,0x23,0 |

Bit-Check 10 Zyklop Mini 1



9 bits, tough, for universal use, 1 Wera Bit Ratchet Zyklop Mini 1, drop-forged full steel design, suitable for 1/4" hex bits as per DIN ISO 1173-C 6.3 and E 6.3 and Wera series 1 and 4. Can also be used with 1/4" sockets by using the Wera socket adaptor 870/1.

| | |
|------------------|--|
| 05073645001 | |
| 8001 A | 1 x 1/4"x87,0 |
| 851/1 Z PH | 1 x PH 1x25; 1 x PH 2x25 |
| 855/1 Z PZ | 1 x PZ 1x25; 1 x PZ 2x25 |
| 867/1 TORX® | 1 x TX 15x25; 1 x TX 20x25; 1 x TX 25x25 |
| 840/1 Z Hex-Plus | 1 x 4,0x25; 1 x 5,0x25 |

Bit-Check 10 Zyklop Mini BiTorsion 1



9 bits, BiTorsion for long service life, extra-tough, for universal use. Take it easy toolfinder: Output colour coding (red = Phillips; black = Pozidriv; green = TORX®; blue = hexagon) and large stamp to enable the desired bit to be easily located. , 1 Wera Bit Ratchet Zyklop Mini 1, drop-forged full steel design, suitable for 1/4" hex bits as per DIN ISO 1173-C 6.3 and E 6.3 and Wera series 1 and 4. Can also be used with 1/4" sockets by using the Wera socket adaptor 870/1.

| | |
|--------------------|--|
| 05057418001 | |
| 8001 A | 1 x 1/4"x87,0 |
| 851/1 BTZ PH | 1 x PH 1x25; 1 x PH 2x25 |
| 855/1 BTZ PZ | 1 x PZ 1x25; 1 x PZ 2x25 |
| 867/1 TORX® BTZ | 1 x TX 15x25; 1 x TX 20x25; 1 x TX 25x25 |
| 840/1 BTZ Hex-Plus | 1 x 4,0x25; 1 x 5,0x25 |



Zyklop Mini

For confined spaces

8001 A Zyklop Mini 1 Bit Ratchet 1/4" SB with 1/4" drive



Application: Suitable for 1/4" hex bits as per DIN ISO 1173-C 6,3 and E 6,3 and Wera series 1 and 4, Wera adaptor 870/1 for 1/4" sockets

Design: Drop-forged full steel design, fine-tooth ratchet mechanism, small return angle of 6°, forward and reverse drive switch

Handle: Kraftform handle with proven Kraftform geometry provides perfectly designed finger contact zones, ergonomic ratchet head and handle

| | | |
|-------------|--------|---------------|
| | | |
| 05073230001 | | |
| | 8001 A | 1 x 1/4"x87,0 |
| | 870/1 | 1 x 1/4"x25 |

Zyklop Mini 2



Application: Suitable for Wera sockets 8790 FA

Design: Drop-forged full steel design, fine-tooth ratchet mechanism, small return angle of 6°, forward and reverse drive switch

Handle: Kraftform handle with proven Kraftform geometry provides perfectly designed finger contact zones, ergonomic ratchet head and handle





| | | |
|-------------|--|-----|
| | | mm |
| 05003660001 | | 107 |



8790 FA Zyklop socket with 1/4" and Hexagon 11 drive



- Application:** Hexagon headed bolts, screws and nuts
Design: 1/4" external square and hexagon size; suitable for 1/4" ratchets and Wera Zyklop Mini 2 ratchet
Handle: Manual applications; ball intercept ring; extremely low height, ideal for confined spaces; chrome vanadium, chrome-plated

| |  mm |  mm |  mm |  mm |  mm |
|-------------|---|---|---|---|---|
| 05003665001 | 4,0 | 11,8 | 9,5 | 18,0 | 6,4 |
| 05003666001 | 4,5 | 11,8 | 9,5 | 18,0 | 7,0 |
| 05003667001 | 5,0 | 11,8 | 9,5 | 18,0 | 7,6 |
| 05003668001 | 5,5 | 11,8 | 9,5 | 18,0 | 8,2 |
| 05003669001 | 6,0 | 11,8 | 9,5 | 18,0 | 9,2 |
| 05003670001 | 7,0 | 11,8 | 9,5 | 18,0 | 10,4 |
| 05003675001 | 8,0 | 11,8 | 9,5 | 18,0 | 11,5 |
| 05003690001 | 10,0 | 11,8 | 9,5 | 18,0 | 13,8 |
| 05003684001 | 12,0 | 11,8 | 9,5 | 18,0 | 16,8 |
| 05003685001 | 13,0 | 11,8 | 9,5 | 18,0 | 17,8 |



” To learn more about this product, scan the QR code. “

Tip

Is such a small tool sufficiently resilient?



The Zyklop Mini 1 can withstand at least 65 Nm. That is far more power than can normally be transferred to such a small tool.

Zyklop Mini 2



The Zyklop Mini 2 is suitable for the direct attachment of the special Wera Zyklop sockets 8790 FA. These sockets feature a very low height, ideal for confined working spaces.



“Take it easy”



“Take it easy” tool finder system – with profile and size colour-coding for quick and easy tool selection. Colour-coded system for hexagon drive screws (L-Keys, Zyklop bit sockets), external hex drive screws and nuts (Joker wrenches, Zyklop sockets and Zyklop bit sockets with holding function), and TORX® drive screws (L-Keys, Zyklop bit sockets).



Joker Wrenches



Joker
Ratcheting combination wrenches

228



Joker Switch
Ratcheting combination wrenches

230



Joker open-ended wrenches

When we began to think about open-ended wrenches, we asked ourselves: why does the wrench always have to be flipped over; why does it have an offset design; why does it slip off injuring fingers? The new design of the mouth resulted in a real “Joker” that works even when all other trumps have been played.



The Joker's holding function means that nuts and bolts can be held in the jaw and easily positioned where they are needed. Fastening on to the thread can then be done quickly and safely, thanks to the innovative special stop-plate which holds the fastener. No more time-wasting searches for dropped nuts and bolts! After applying and positioning the nut or bolt, fastening can begin immediately – no additional tools required.



Constant re-positioning of the wrench? Difficulty holding fasteners in confined spaces? Easing off to avoid any risks of injury or fastener damage? That was yesterday. Today, the Joker prevents slipping off of the fastener head with its integrated limit-stop – no longer is the thumb needed to act as a depth stop. This makes applications much easier and allows significantly more force to be applied during fastening jobs.



The Joker's clever double-hex geometry delivers a very positive connection with nuts or bolts – it's a perfect fit. And the exchangeable, hardened metal gripping plate in the Joker's mouth literally bites itself into the bolt, with its extremely hard tips. Both features combine to prevent slipping, even at higher torque.



Instead of 60°, the Joker only has a 30° return angle thanks to its unique double-hex design. Along with the Joker's straight neck, this means that flipping the wrench has become a thing of the past. With the Joker, you can now loosen and tighten nuts and bolts, in situations where conventional tools fail. Particularly in confined spaces, where conventional open-jawed wrenches cannot be used. The combination of limit stop and small return angle enables effective work, even on screw pipe connections.



The ratcheting feature at the ring end boasts an exceptional, fine tooth mechanism – 80 teeth in all – which provides greater flexibility, even in very confined workspaces.

Joker

Combination ratchet wrenches

Joker Ratcheting combination wrenches



Application: Hexagonal nuts or bolts

Design: Ratcheting combination wrench

| | | mm | mm | mm | mm | mm | mm |
|-------------|--|----|-------|------|-----|------|------|
| 05073268001 | | 8 | 144 | 20 | 5,5 | 18 | 7 |
| 05073270001 | | 10 | 159 | 22 | 5,5 | 21 | 7,2 |
| 05073271001 | | 11 | 165 | 25 | 6,3 | 22 | 7,5 |
| 05073272001 | | 12 | 170,7 | 26,3 | 6,6 | 25 | 8,5 |
| 05073273001 | | 13 | 177 | 27,3 | 7 | 25 | 8,6 |
| 05073274001 | | 14 | 188 | 29,3 | 7,5 | 28 | 9,2 |
| 05073275001 | | 15 | 200 | 32,3 | 7,8 | 28,5 | 9,2 |
| 05073276001 | | 16 | 212 | 35 | 8,2 | 32,7 | 10,5 |
| 05073277001 | | 17 | 224 | 37,2 | 8,5 | 32,7 | 10,5 |
| 05073278001 | | 18 | 235 | 39 | 9 | 33,8 | 11 |
| 05073279001 | | 19 | 246 | 42 | 9,5 | 34,8 | 11 |

Joker Double open-ended wrenches

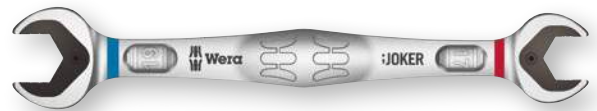

Application: Hexagon bolts and nuts

Design: Double open-ended wrench

| | | mm | mm | mm | mm | mm | mm |
|-------------|--|----|----|----|----|-----|-----|
| 05003760001 | | 10 | 23 | 13 | 27 | 5,5 | 7 |
| 05003765001 | | 17 | 37 | 19 | 42 | 8,5 | 9,5 |

Joker Set of Ratcheting combination wrenches



Set of ratcheting combination wrenches

11-piece set

Durable pouch

| | | mm | mm | mm | mm | mm | mm |
|-------------|--------------|---|----|----|----|----|----|
| 05020013001 | Joker | 1 x 8x144; 1 x 10x159; 1 x 11x165; 1 x 12x170,7; 1 x 13x177; 1 x 14x188; 1 x 15x200; 1 x 16x212; 1 x 17x224; 1 x 18x235; 1 x 19x246 | | | | | |

Joker Ratcheting combination wrenches, imperial



Application: Hexagonal nuts or bolts

Design: Ratcheting combination wrench

| | | mm | mm | mm | mm | mm | mm |
|-------------|--|--------|-----|------|-----|------|------|
| 05073280001 | | 5/16" | 144 | 20 | 5,5 | 18 | 7 |
| 05073281001 | | 3/8" | 159 | 22 | 5,5 | 21 | 7,2 |
| 05073282001 | | 7/16" | 165 | 25 | 6,3 | 22 | 7,5 |
| 05073283001 | | 1/2" | 177 | 27,3 | 7 | 25 | 8,6 |
| 05073284001 | | 9/16" | 188 | 29,3 | 7,5 | 28 | 9,2 |
| 05073285001 | | 5/8" | 212 | 35 | 8,2 | 32,7 | 10,5 |
| 05073286001 | | 11/16" | 235 | 39 | 9 | 33,8 | 11 |
| 05073287001 | | 3/4" | 246 | 42 | 9,5 | 34,8 | 11 |

Joker Set of Ratcheting combination wrenches, imperial



Set of ratcheting combination wrenches
8-piece set
Durable pouch

| | |
|-------------|---|
| 05020012001 | |
| Joker inch | 1 x 5/16"x144; 1 x 3/8"x159; 1 x 7/16"x165; 1 x 1/2"x177; 1 x 9/16"x188; 1 x 5/8"x212; 1 x 11/16"x235; 1 x 3/4"x246 |

Joker Set of Ratcheting combination / double open-ended wrenches



Ratcheting Combination/Double Open-Ended Wrench Set
6-piece set
Durable pouch

| | |
|--------------|---|
| 05020022001 | |
| Joker | 1 x 10x159; 1 x 13x177; 1 x 17x224; 1 x 19x246 |
| Joker Double | 1 x 10x13x167; 1 x 17x19x235 |

Tip

Fine tooth mechanism



The ratcheting feature at the ring end boasts an exceptional, fine tooth mechanism – 80 teeth in all – which provides greater flexibility, even in very confined working spaces.

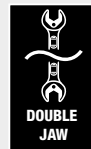

Double open-ended wrench



The Joker double open-ended wrench is ideally suited for locking down nuts and bolts.



“Take it easy”



“Take it easy” tool finder system – with profile and size colour-coding for quick and easy tool selection. Colour-coded system for hexagon drive screws (L-Keys, Zyklop bit sockets), external hex drive screws and nuts (Joker wrenches, Zyklop sockets and Zyklop bit sockets with holding function), and TORX® drive screws (L-Keys, Zyklop bit sockets).

Joker

Combination ratchet wrenches

Joker Set of Ratcheting combination wrenches



Set of ratcheting combination wrenches
4-piece set
Durable pouch

| | |
|---|---|
|  | |
| 05073290001 | |
| Joker | 1 x 10x159; 1 x 13x177; 1 x 17x224; 1 x 19x246 |

Joker Set of Ratcheting combination wrenches, imperial



Set of ratcheting combination wrenches
4-piece set
Durable pouch

| | |
|---|---|
|  | |
| 05073295001 | |
| Joker inch | 1 x 7/16"x165; 1 x 1/2"x177; 1 x 9/16"x188; 1 x 3/4"x246 |









” To learn more about this product, scan the QR code. “

Joker Switch Ratcheting combination wrenches, with switch lever



Application: Hexagonal nuts or bolts

Design: Ratcheting combination wrench, switch lever for convenient change of direction; ring end angled at 15° from the handle





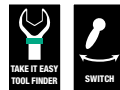

| | | | | | | | |
|---|---|---|---|---|---|---|--|
|  | | | | | | | |
| |  |  |  |  |  |  | |
| | mm | mm | mm | mm | mm | mm | |
| 05020064001 | 8 | 144 | 20,3 | 5,5 | 18 | 7 | |
| 05020065001 | 10 | 159 | 23 | 5,5 | 21,5 | 7,5 | |
| 05020066001 | 11 | 165 | 24,3 | 6,3 | 22 | 7,5 | |
| 05020067001 | 12 | 171 | 26,3 | 6,6 | 25 | 8,5 | |
| 05020068001 | 13 | 179 | 27,3 | 7 | 26 | 8,5 | |
| 05020069001 | 14 | 187 | 30 | 7,5 | 28 | 9,5 | |
| 05020070001 | 15 | 199 | 32 | 7,8 | 28,8 | 9,5 | |
| 05020071001 | 16 | 213 | 35 | 8,2 | 31,7 | 10,5 | |
| 05020072001 | 17 | 225 | 37 | 8,5 | 33 | 10,5 | |
| 05020073001 | 18 | 234 | 39,5 | 9 | 34 | 11 | |
| 05020074001 | 19 | 246 | 42 | 9,5 | 34,7 | 11 | |

Joker Switch Ratcheting combination wrenches, Imperial, with switch lever



Application: Hexagonal nuts or bolts

Design: Ratcheting combination wrench, switch lever for convenient change of direction; ring end angled at 15° from the handle

| | | | | | | | |
|---|---|---|---|---|---|---|--|
|  | | | | | | | |
| |  |  |  |  |  |  | |
| | mm | mm | mm | mm | mm | mm | |
| 05020075001 | 5/16" | 144 | 20,3 | 5,5 | 18 | 7 | |
| 05020076001 | 3/8" | 159 | 23 | 5,5 | 21,5 | 7,5 | |
| 05020077001 | 7/16" | 165 | 24,3 | 6,3 | 22 | 7,5 | |
| 05020078001 | 1/2" | 171 | 26,3 | 6,6 | 25 | 8,5 | |
| 05020079001 | 9/16" | 187 | 30 | 7,5 | 28 | 9,5 | |
| 05020080001 | 5/8" | 213 | 35 | 8,2 | 31,7 | 10,5 | |
| 05020081001 | 11/16" | 234 | 39,5 | 9 | 34 | 11 | |
| 05020082001 | 3/4" | 246 | 42 | 9,5 | 34,7 | 11 | |

Joker Switch Set of Ratcheting combination wrenches

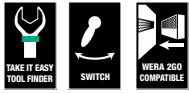

Set of ratcheting combination wrenches, reversible

4-piece set

Durable pouch

| | |
|-------------|---|
| | |
| 05020090001 | |
| | Joker Switch 1 x 10x159; 1 x 13x179; 1 x 17x225; 1 x 19x246 |

Joker Switch Set of Ratcheting combination wrenches, imperial



Set of ratcheting combination wrenches, reversible

4-piece set

Durable pouch

| | |
|-------------|---|
| | |
| 05020092001 | |
| | Joker Switch 1 x 7/16"x165; 1 x 1/2"x171; 1 x 9/16"x187; inch 1 x 3/4"x246 |

Tip

Fine tooth mechanism



The ratcheting feature at the ring end boasts an exceptional, fine tooth mechanism – 80 teeth in all – which provides greater flexibility, even in very confined working spaces.

Angled ratchet end



The ratchet end is angled at 15° to the tool axis, making application of the tool in confined spaces much easier.

Joker Switch



The direction of the fine-tooth ratchet mechanism can easily be changed via the smooth switch lever.

Joker

Combination ratchet wrenches

Joker Switch Set of Ratcheting combination wrenches, Imperial

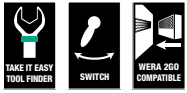

Set of ratcheting combination wrenches, reversible
 8-piece set
 Durable pouch

| | |
|--|---|
|  | |
| 05020093001 | |
| Joker Switch inch | 1 x 5/16"x144; 1 x 3/8"x159; 1 x 7/16"x165; 1 x 1/2"x171; 1 x 9/16"x187; 1 x 5/8"x213; 1 x 11/16"x234; 1 x 3/4"x246 |

Joker Switch Set of Ratcheting combination wrenches

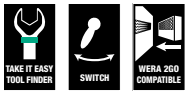

Set of ratcheting combination wrenches, reversible
 11-piece set
 Durable pouch

| | |
|---|--|
|  | |
| 05020091001 | |
| Joker Switch | 1 x 8x144; 1 x 10x159; 1 x 11x165; 1 x 12x171; 1 x 13x179; 1 x 14x187; 1 x 15x199; 1 x 16x213; 1 x 17x225; 1 x 18x234; 1 x 19x246 |

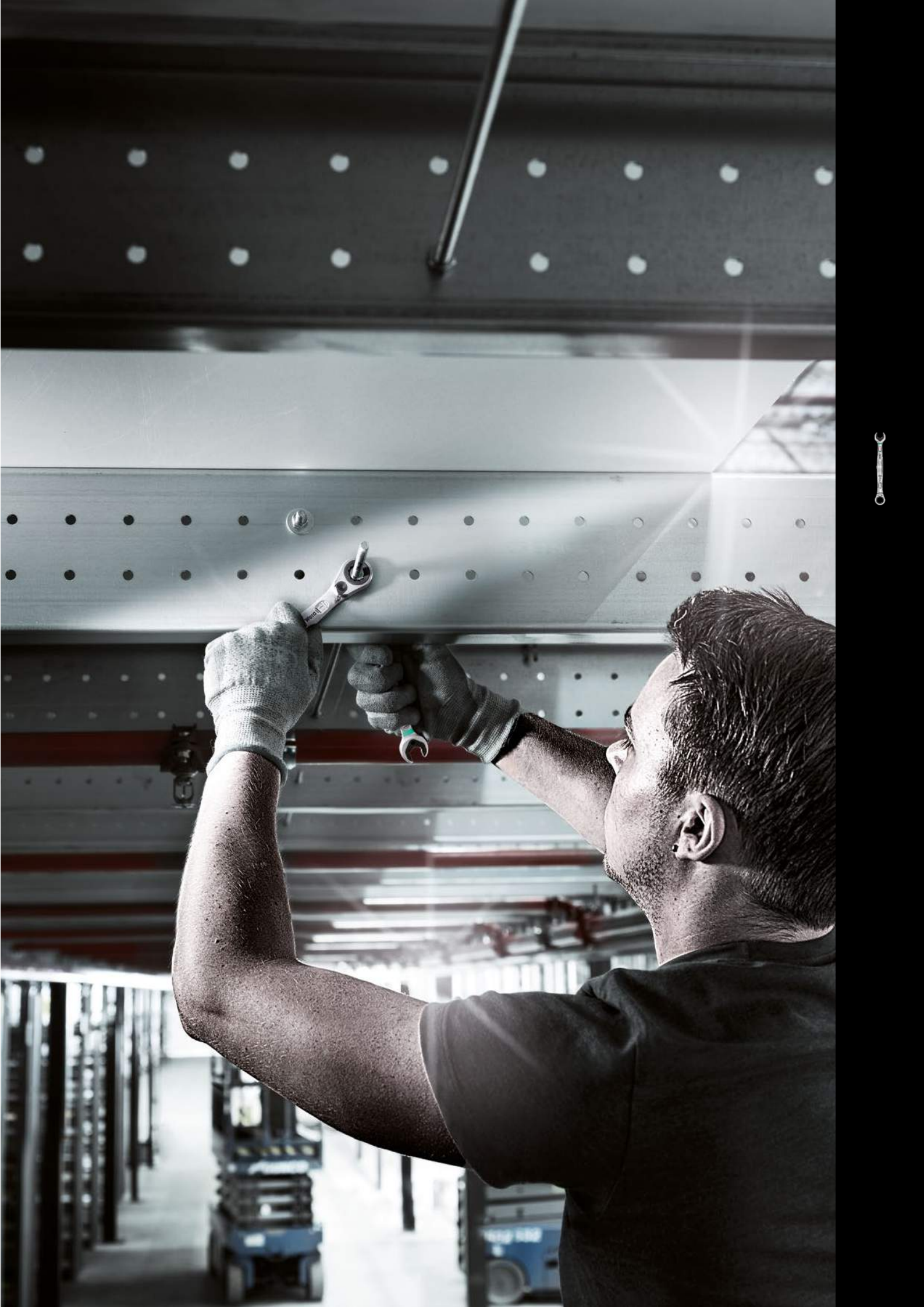



L-Keys



L-Keys for Hexagon Socket Screws

238



L-Keys for TORX® Screws

250



Offset Screwdrivers

257



L-Keys

We questioned the classic L-key design, since all too often the screw head recess is rounded out, meaning screws can no longer be tightened or loosened – and so the user finds the L-key slipping out of the recess.

Wera Hex-Plus tools have a larger contact surface in the screw head. The notching effects are reduced and thereby the deformation of the screws. At the same time, as much as 20 % more torque can be applied.



Stainless L-keys are hardened to the same strength as conventional (carbon) steel tools, and prevent extraneous rust forming.



SPKL – protects fingers! L-keys with a thermoplastic sleeve (SPKL) are manufactured out of easy-to-grip, circular material. The sleeve ensures that work is safe and comfortable even at low temperatures. High corrosion protection features thanks to the special BlackLaser surface treatment. Colour coding and large stamp to enable the desired L-key to be easily located.



Chrome-plated hexagon L-keys or with BlackLaser surface treatment for outstanding surface protection and long service life. High corrosion protection.



The size of each L-keys has been engraved by a laser. In addition SPKL L-keys have a colour coding according to sizes – for simple and rapid accessing of the required tool. Making it easy to find the right tool.



The wear-resistant clip material ensures that the L-keys are securely held yet are easy to remove.

L-Keys for Hexagon Socket Screws

The Hex-Plus profile extends the service life of hexagon socket screws

3950/9 Hex-Plus Multicolour Stainless 1 L-key set, metric, stainless

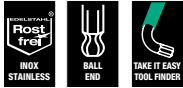

9-piece set in a two-component clip

Application: Hexagon socket screws

Design: Stainless steel, durable plastic sleeve. The contrasting inscriptions on the colour-coded sleeves mean that it is easy to recognise the correct sizes and this makes it simpler to find the right tool.

Tip: Hex-Plus, ball-end hexagon on long arm

| | |
|-------------|--|
| | |
| 05022669001 | |
| ○ | 3950 SPKL Multicolour 1 x 1,5x90; 1 x 2,0x101; 1 x 2,5x112; 1 x 3,0x123; 1 x 4,0x137; 1 x 5,0x154; 1 x 6,0x172; 1 x 8,0x195; 1 x 10,0x224 |

3950/9 Hex-Plus Stainless 1 L-key set, metric, stainless



9-piece set in a two-component clip

Application: Hexagon socket screws

Design: Stainless steel

Tip: Hex-Plus, ball-end hexagon on long arm

| | |
|-------------|---|
| 05022720001 | |
| ○ | 3950 PKL 1 x 1,5x90; 1 x 2,0x101; 1 x 2,5x112; 1 x 3,0x123; 1 x 4,0x137; 1 x 5,0x154; 1 x 6,0x172; 1 x 8,0x195; 1 x 10,0x224 |

3950/9 Hex-Plus Stainless 1 SB L-key set, metric, stainless

| | |
|-------------|---|
| | |
| 05073544001 | 4013288 180377 |
| ○ | 3950 PKL 1 x 1.5x90; 1 x 2.0x101; 1 x 2.5x112; 1 x 3.0x123; 1 x 4.0x137; 1 x 5.0x154; 1 x 6.0x172; 1 x 8.0x195; 1 x 10.0x224 |



3950/9 Hex-Plus Imperial Stainless 1 L-key set, imperial, stainless



9-piece set in belt pouch

Application: Hexagon socket screws

Design: Stainless steel

Tip: Hex-Plus, ball-end hexagon on long arm

| | |
|---|--|
|  | |
| 05022721001 | |
| ○ | 3950 PKL inch 1 x 3/32"x112; 1 x 7/64"x119; 1 x 1/8"x123; 1 x 9/64"x130; 1 x 5/32"x137; 1 x 3/16"x154; 1 x 1/4"x185; 1 x 5/16"x195; 1 x 3/8"x224 |

Tip



“Take it easy”



“Take it easy” tool finder system – with profile and size colour-coding for quick and easy tool selection. Colour-coded system for hexagon drive screws (L-Keys, Zyklop bit sockets), external hex drive screws and nuts (Joker wrenches, Zyklop sockets and Zyklop bit sockets with holding function), and TORX® drive screws (L-Keys, Zyklop bit sockets).

Why do the SPKL L-keys from Wera have a round design and come with a rubber sleeve?



L-keys made from circular material fit into the hand better and allow less strenuous work over a longer period. Additionally, the rubber sleeve provides a pleasant grip, particularly in applications at low temperatures. Colour coding and large stamp enable the desired L-key to be easily located. Moreover, the round material keys are more robust, particularly where smaller sizes are concerned.



TORX® and hexagon ball tip



The spherical drive profile means that it is possible to swivel the axis of the tool to that of the screw, and therefore enable angled, “around-the-corner” screwdriving jobs. This ball tip geometry – often found on L-keys – is now available on a number of Wera bits.



L-Keys for Hexagon Socket Screws

The Hex-Plus profile extends the service life of hexagon socket screws

950/9 Hex-Plus Multicolour HF 1 L-key set, metric, BlackLaser, with holding function

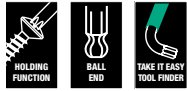



9-piece set in a two-component clip

Application: Hexagon socket screws

Design: BlackLaser surface, durable plastic sleeve. The contrasting inscriptions on the colour-coded sleeves mean that it is easy to recognise the correct sizes and this makes it simpler to find the right tool.

Tip: Hex-Plus, ball-end hexagon on long arm, holding function for hexagon socket screws, sizes: 1.5, 2.0 and 2.5 without holding function

| | |
|---|--|
|  | |
| 05022210001 | |
|  | 950 SPKL Multicolour 1 x 1,5x90; 1 x 2,0x101; 1 x 2,5x112 |
|  | 950 SPKL HF Multicolour 1 x 3,0x123; 1 x 4,0x137; 1 x 5,0x154; 1 x 6,0x172; 1 x 8,0x195; 1 x 10,0x224 |

950/9 Hex-Plus Multicolour 1 L-key set, metric, BlackLaser



9-piece set in a two-component clip



Application: Hexagon socket screws

Design: BlackLaser surface, durable plastic sleeve. The contrasting inscriptions on the colour-coded sleeves mean that it is easy to recognise the correct sizes and this makes it simpler to find the right tool.

Tip: Hex-Plus, ball-end hexagon on long arm

| | |
|---|---|
| 05022089001 | |
|  | 950 SPKL Multicolour 1 x 1,5x90; 1 x 2,0x101; 1 x 2,5x112; 1 x 3,0x123; 1 x 4,0x137; 1 x 5,0x154; 1 x 6,0x172; 1 x 8,0x195; 1 x 10,0x224 |

950/9 Hex-Plus Multicolour 1 SB L-key set, metric, BlackLaser

| | |
|--|---|
|  | |
| 05073593001 |  4013288 165688 |
|  | 950 SPKL Multicolour 1 x 1.5x90; 1 x 2.0x101; 1 x 2.5x112; 1 x 3.0x123; 1 x 4.0x137; 1 x 5.0x154; 1 x 6.0x172; 1 x 8.0x195; 1 x 10.0x224 |



950/9 Hex-Plus Multicolour Imperial 1 L-key set, imperial, BlackLaser



9-piece set in belt pouch

Application: Hexagon socket screws

Design: BlackLaser surface, durable plastic sleeve. The contrasting inscriptions on the colour-coded sleeves mean that it is easy to recognise the correct sizes and this makes it simpler to find the right tool.

Tip: Hex-Plus, ball-end hexagon on long arm

| | |
|-------------|--|
| 05022639001 | |
| ○ | 950 SPKL inch 1 x 5/64"x101; 1 x 3/32"x112; 1 x 1/8"x123; 1 x 5/32"x137; 1 x 3/16"x154; 1 x 7/32"x172; 1 x 1/4"x185; 1 x 5/16"x195; 1 x 3/8"x224 |

950/7 Hex-Plus Multicolour Magnet 1 L-key set, metric, BlackLaser



7-piece set in a two-component clip. For recessed screws, it's often advantageous for the screw to be held on the L-key by magnetic force. The Wera clips with magnetiser/demagnetiser enable a magnetisation/demagnetisation of L-keys in a flash.

Application: Hexagon socket screws

Design: BlackLaser surface, durable plastic sleeve. The contrasting inscriptions on the colour-coded sleeves mean that it is easy to recognise the correct sizes and this makes it simpler to find the right tool.

Tip: Hex-Plus, ball-end hexagon on long arm

| | |
|-------------|---|
| 05022534001 | |
| ○ | 950 SPKL 1 x 1,5x90; 1 x 2,0x101; 1 x 2,5x112; 1 x 3,0x123; 1 x 4,0x137; 1 x 5,0x154; 1 x 6,0x172 |

Tip



“Take it easy”



“Take it easy” tool finder system – with profile and size colour-coding for quick and easy tool selection. Colour-coded system for hexagon drive screws (L-Keys, Zyklop bit sockets), external hex drive screws and nuts (Joker wrenches, Zyklop sockets and Zyklop bit sockets with holding function), and TORX® drive screws (L-Keys, Zyklop bit sockets).



Holding function on long arm



The clamping of the screw is achieved by a flexible locking ball. The holding function is especially helpful in confined, hard-to-reach spaces, where there is no room for a second hand to secure the screw.



Magnetiser/Demagnetiser



Magnetising

For recessed screws, it's often advantageous for the screw to be held on the L-key by magnetic force. The Wera clips with magnetiser/demagnetiser enable a magnetisation/demagnetisation of L-keys in a flash.



Demagnetising

L-Keys for Hexagon Socket Screws

The Hex-Plus profile extends the service life of hexagon socket screws

950/9 Hex-Plus 1 L-key set, metric, chrome-plated



9-piece set in a two-component clip

Application: Hexagon socket screws

Design: Chrome-plated

Tip: Hex-Plus, ball-end hexagon on long arm

| | |
|-------------|---|
| 05022087001 | |
| ○ | 950 PKL 1 x 1,5x90 ¹⁾ ; 1 x 2,0x100; 1 x 2,5x112; 1 x 3,0x126; 1 x 4,0x140; 1 x 5,0x160; 1 x 6,0x180; 1 x 8,0x200; 1 x 10,0x219 |

¹⁾ Regular hexagon

950/9 Hex-Plus 2 L-key set, metric, chrome-plated



9-piece set in a two-component clip

Application: Hexagon socket screws

Design: Chrome-plated

Tip: Hex-Plus

| | |
|-------------|---|
| 05021909001 | |
| ○ | 950 L 1 x 1,5x90 ¹⁾ ; 1 x 2,0x100; 1 x 2,5x112; 1 x 3,0x126; 1 x 4,0x140; 1 x 5,0x160; 1 x 6,0x180; 1 x 8,0x200; 1 x 10,0x219 |

¹⁾ Regular hexagon

950/9 Hex-Plus 1 SB L-key set, metric, chrome-plated

| | | |
|-------------|---|---|
| | |  |
| | | 4013288 |
| 05073391001 | | 030160 |
| ○ | 950 PKL 1 x 1,5x90 ¹⁾ ; 1 x 2,0x100; 1 x 2,5x112; 1 x 3,0x126; 1 x 4,0x140; 1 x 5,0x160; 1 x 6,0x180; 1 x 8,0x200; 1 x 10,0x219 | |



¹⁾ Regular hexagon



9-piece set in a two-component clip

Application: Hexagon socket screws

Design: Chrome-plated

Tip: Hex-Plus, ball-end hexagon on long arm

| | |
|-------------|--|
| 05133163001 | |
| ○ | 950 PKS 1 x 1,5x50 ¹⁾ ; 1 x 2,0x56; 1 x 2,5x63; 1 x 3,0x71; 1 x 4,0x80; 1 x 5,0x90; 1 x 6,0x100; 1 x 8,0x112; 1 x 10,0x125 |

¹⁾ Regular hexagon

950/9 Hex-Plus 4 L-key set, metric, chrome-plated

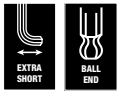

9-piece set in a two-component clip

Application: Hexagon socket screws

Blade: Chrome plated, with extra short arm for use on screws that are difficult to access

Tip: Hex-Plus, ballpoint hexagon on long arm

| | |
|-------------|---|
| 05073594001 | |
| ○ | 950 PKLS 1 x 1,5x90 ¹⁾ ; 1 x 2,0x100; 1 x 2,5x112; 1 x 3,0x126; 1 x 4,0x140; 1 x 5,0x160; 1 x 6,0x180; 1 x 8,0x200; 1 x 10,0x219 |

¹⁾ Regular hexagon

950/9 Hex-Plus 5 L-key set, metric, chrome-plated



9-piece set in a two-component clip

Application: Hexagon socket screws

Design: Chrome-plated

Tip: Hex-Plus

| | |
|-------------|--|
| 05021406001 | |
| ○ | 950 1 x 1,5x45 ¹⁾ ; 1 x 2,0x50; 1 x 2,5x56; 1 x 3,0x63; 1 x 4,0x70; 1 x 5,0x80; 1 x 6,0x90; 1 x 8,0x100; 1 x 10,0x112 |

¹⁾ Regular hexagon.

Tip



Hex-Plus for hexagon socket screws



Hexagon screws can endure a problem because the contact surfaces delivering the power from the conventional tool, is transferred to the screw via very small surface areas. The consequence: the screw can become damaged (rounding out). Hex-Plus tools have a greater contact surface that prevents this from happening! At the same time, as

much as 20 % more torque can be applied. Good to know: Hex-Plus tools fit into every standard hexagon socket screw!



Ball tip



The spherical drive profile means that it is possible to swivel the axis of the tool to that of the screw, and therefore enable angled, "around-the-corner" screwdriving jobs.



L-Keys for Hexagon Socket Screws

The Hex-Plus profile extends the service life of hexagon socket screws

950/9 Hex-Plus 6 L-key set, metric, BlackLaser



9-piece set in a two-component clip

Application: Hexagon socket screws

Design: BlackLaser surface

Tip: Hex-Plus, ball-end hexagon on long arm

| | |
|-------------|---|
| 05022086001 | |
| ○ | 950 PKL BM 1 x 1,5x90 ¹⁾ ; 1 x 2,0x100; 1 x 2,5x112; 1 x 3,0x126; 1 x 4,0x140; 1 x 5,0x160; 1 x 6,0x180; 1 x 8,0x200; 1 x 10,0x219 |

¹⁾ Regular hexagon

950/9 Hex-Plus 6 SB L-key set, metric, BlackLaser

| | |
|-------------|---|
| | |
| 05073596001 | 106414 |
| ○ | 950 PKL BM 1 x 1.5x90 ¹⁾ ; 1 x 2.0x100; 1 x 2.5x112; 1 x 3.0x126; 1 x 4.0x140; 1 x 5.0x160; 1 x 6.0x180; 1 x 8.0x200; 1 x 10.0x219 |



¹⁾ Regular hexagon

950/9 Hex-Plus 7 L-key set, metric, BlackLaser



9-piece set in a two-component clip

Application: Hexagon socket screws

Design: BlackLaser surface

Tip: Hex-Plus

| | |
|-------------|---|
| 05021737001 | |
| ○ | 950 BM 1 x 1,5x45 ¹⁾ ; 1 x 2,0x50; 1 x 2,5x56; 1 x 3,0x63; 1 x 4,0x70; 1 x 5,0x80; 1 x 6,0x90; 1 x 8,0x100; 1 x 10,0x112 |

¹⁾ Regular hexagon.

950/7 Hex-Plus Magnet 1 L-key set, metric, chrome-plated



7-piece set in a two-component clip. For recessed screws, it's often advantageous for the screw to be held on the L-key by magnetic force. The Wera clips with magnetiser/demagnetiser enable a magnetisation/demagnetisation of L-keys in a flash.

Application: Hexagon socket screws

Design: Chrome-plated

Tip: Hex-Plus, ball-end hexagon on long arm

| | |
|-------------|---|
| 05022101001 | |
| ○ | 950 PKL 1 x 1,5x90 ¹⁾ ; 1 x 2,0x100; 1 x 2,5x112; 1 x 3,0x126; 1 x 4,0x140; 1 x 5,0x160; 1 x 6,0x180 |

¹⁾ Regular hexagon

950/7 Hex-Plus 1 L-key set, metric, chrome-plated



7-piece set in a two-component clip

Application: Hexagon socket screws

Design: Chrome-plated

Tip: Hex-Plus, ball-end hexagon on long arm

| | |
|-------------|---|
| 05022181001 | |
| ○ | 950 PKL 1 x 1,5x90 ¹⁾ ; 1 x 2,0x100; 1 x 2,5x112; 1 x 3,0x126; 1 x 4,0x140; 1 x 5,0x160; 1 x 6,0x180 |

¹⁾ Regular hexagon

950/13 Hex-Plus Imperial 1 L-key set, imperial, BlackLaser



13-piece set in a two-component clip

Application: Hexagon socket screws

Design: BlackLaser surface

Tip: Hex-Plus, ball-end hexagon on long arm

| | |
|-------------|--|
| 05021728001 | |
| ○ | 950 PKL inch 1 x 0,05"x83 ¹⁾ ; 1 x 1/16"x91 ¹⁾ ; 1 x 5/64"x100; 1 x 3/32"x112; 1 x 7/64"x119; 1 x 1/8"x126; 1 x 9/64"x132; 1 x 5/32"x140; 1 x 3/16"x160; 1 x 7/32"x180; 1 x 1/4"x190; 1 x 5/16"x200; 1 x 3/8"x212 |

¹⁾ Regular hexagon

950/9 Hex-Plus Imperial 1 L-key set, imperial, BlackLaser



9-piece set in a two-component clip

Application: Hexagon socket screws

Design: BlackLaser surface

Tip: Hex-Plus, ball-end hexagon on long arm

| | |
|-------------|--|
| 05022171001 | |
| ○ | 950 PKL inch 1 x 5/64"x100; 1 x 3/32"x112; 1 x 1/8"x126; 1 x 5/32"x140; 1 x 3/16"x160; 1 x 7/32"x180; 1 x 1/4"x190; 1 x 5/16"x200; 1 x 3/8"x212 |

950/9 Hex-Plus Imperial 1 SB L-key set, imperial, BlackLaser

| | | |
|-------------|---|--|
| | |  4013288 |
| 05133180001 | | 154118 |
| ○ | 950 PKL inch 1 x 5/64"x100; 1 x 3/32"x112; 1 x 1/8"x126; 1 x 5/32"x140; 1 x 3/16"x160; 1 x 7/32"x180; 1 x 1/4"x190; 1 x 5/16"x200; 1 x 3/8"x212 | |



Tip



Are there any advantages of an L-key with an extra short arm?



All users will recognise the need to saw or grind down L-keys to make them shorter for particularly confined screwdriving jobs. This has the disadvantage that they no longer have any corrosion protection at the separation point and secondly, they can become "soft" and therefore useless due to an alteration in the hardening during the shortening process.



L-Keys for Hexagon Socket Screws

The Hex-Plus profile extends the service life of hexagon socket screws

3950 SPKL Multicolour L-key, metric, stainless



Application: Hexagon socket screws

Design: Stainless steel, durable plastic sleeve. The contrasting inscriptions on the colour-coded sleeves mean that it is easy to recognise the correct sizes and this makes it simpler to find the right tool.

Tip: Hex-Plus, ball-end hexagon on long arm

| | ⊙ | L | L | L | L |
|-------------|------|-----|----|----------|----------|
| | mm | mm | mm | mm | mm |
| 05022660001 | 1,5 | 90 | 14 | 3 1/2" | 9/16" |
| 05022661001 | 2,0 | 101 | 16 | 4" | 5/8" |
| 05022662001 | 2,5 | 112 | 19 | 4 7/16" | 3/4" |
| 05022663001 | 3,0 | 123 | 21 | 4 7/8" | 27/32" |
| 05022664001 | 4,0 | 137 | 24 | 5 3/8" | 1" |
| 05022665001 | 5,0 | 154 | 27 | 6 1/16" | 1 1/16" |
| 05022666001 | 6,0 | 172 | 31 | 6 3/4" | 1 1/4" |
| 05022667001 | 8,0 | 195 | 37 | 7 11/16" | 1 7/16" |
| 05022668001 | 10,0 | 224 | 42 | 9" | 1 11/16" |

3950 PKL L-key, metric, stainless



Application: Hexagon socket screws

Design: Stainless steel

Tip: Hex-Plus, ball-end hexagon on long arm

| | ⊙ | L | L | L | L |
|-------------|------|-----|----|----------|----------|
| | mm | mm | mm | mm | mm |
| 05022700001 | 1,5 | 90 | 14 | 3 1/2" | 9/16" |
| 05022701001 | 2,0 | 101 | 16 | 4" | 5/8" |
| 05022702001 | 2,5 | 112 | 19 | 4 7/16" | 3/4" |
| 05022703001 | 3,0 | 123 | 21 | 4 7/8" | 27/32" |
| 05022704001 | 4,0 | 137 | 24 | 5 3/8" | 1" |
| 05022705001 | 5,0 | 154 | 27 | 6 1/16" | 1 1/16" |
| 05022706001 | 6,0 | 172 | 31 | 6 3/4" | 1 1/4" |
| 05022708001 | 8,0 | 195 | 37 | 7 11/16" | 1 7/16" |
| 05022709001 | 10,0 | 224 | 42 | 9" | 1 11/16" |

3950 PKL L-key, imperial, stainless



Application: Hexagon socket screws

Design: Stainless steel

Tip: Hex-Plus, ball-end hexagon on long arm

| | ⊙ | L | L | L | L |
|-------------|-------|-----|----|----------|----------|
| | mm | mm | mm | mm | mm |
| 05022710001 | 3/32" | 112 | 19 | 4 7/16" | 3/4" |
| 05022711001 | 7/64" | 119 | 20 | 4 3/4" | 25/32" |
| 05022712001 | 1/8" | 123 | 21 | 4 7/8" | 27/32" |
| 05022713001 | 9/64" | 130 | 22 | 5 3/16" | 29/32" |
| 05022714001 | 5/32" | 137 | 24 | 5 3/8" | 1" |
| 05022715001 | 3/16" | 154 | 27 | 6 1/16" | 1 1/16" |
| 05022716001 | 1/4" | 185 | 34 | 7 1/4" | 1 5/16" |
| 05022717001 | 5/16" | 195 | 37 | 7 11/16" | 1 7/16" |
| 05022718001 | 3/8" | 224 | 42 | 9" | 1 11/16" |

950 SPKL HF L-key Multicolour, metric, with holding function



Application: Hexagon socket screws

Design: BlackLaser surface, durable plastic sleeve. The contrasting inscriptions on the colour-coded sleeves mean that it is easy to recognise the correct sizes and this makes it simpler to find the right tool.

Tip: Hex-Plus, ball-end hexagon on long arm, holding function for hexagon socket screws

| | ⊙ | L | L | L | L |
|-------------|------|-----|----|----------|----------|
| | mm | mm | mm | mm | mm |
| 05022200001 | 3,0 | 123 | 21 | 4 7/8" | 27/32" |
| 05022201001 | 4,0 | 137 | 24 | 5 3/8" | 1" |
| 05022202001 | 5,0 | 154 | 27 | 6 1/16" | 1 1/16" |
| 05022203001 | 6,0 | 172 | 31 | 6 3/4" | 1 1/4" |
| 05022204001 | 8,0 | 195 | 37 | 7 11/16" | 1 7/16" |
| 05022205001 | 10,0 | 224 | 42 | 9" | 1 11/16" |

950 SPKL L-key Multicolour, metric



Application: Hexagon socket screws

Design: BlackLaser surface, durable plastic sleeve. The contrasting inscriptions on the colour-coded sleeves mean that it is easy to recognise the correct sizes and this makes it simpler to find the right tool.

Tip: Hex-Plus, ball-end hexagon on long arm

| | ⊙ | L ₁ | L ₂ | L ₃ | L ₄ |
|-------------|------|----------------|----------------|----------------|----------------|
| | mm | mm | mm | | |
| 05022600001 | 1,5 | 90 | 14 | 3 1/2" | 9/16" |
| 05022602001 | 2,0 | 101 | 16 | 4" | 5/8" |
| 05022604001 | 2,5 | 112 | 19 | 4 7/16" | 3/4" |
| 05022606001 | 3,0 | 123 | 21 | 4 7/8" | 27/32" |
| 05022608001 | 4,0 | 137 | 24 | 5 3/8" | 1" |
| 05022610001 | 5,0 | 154 | 27 | 6 1/16" | 1 1/16" |
| 05022612001 | 6,0 | 172 | 31 | 6 3/4" | 1 1/4" |
| 05022614001 | 8,0 | 195 | 37 | 7 11/16" | 1 7/16" |
| 05022616001 | 10,0 | 224 | 42 | 9" | 1 11/16" |

950 PKL L-key, metric, chrome-plated



Application: Hexagon socket screws

Design: Chrome-plated

Tip: Hex-Plus, ball-end hexagon on long arm

| | ⊙ | L ₁ | L ₂ | L ₃ | L ₄ |
|---------------------------|------|----------------|----------------|----------------|----------------|
| | mm | mm | mm | | |
| 05022050001 ¹⁾ | 1,5 | 90 | 14 | 3 1/2" | 9/16" |
| 05022052001 | 2,0 | 100 | 16 | 4" | 5/8" |
| 05022054001 | 2,5 | 112 | 18 | 4 7/16" | 23/32" |
| 05022056001 | 3,0 | 126 | 20 | 5" | 25/32" |
| 05022058001 | 4,0 | 140 | 25 | 5 1/2" | 1" |
| 05022060001 | 5,0 | 160 | 28 | 6 5/16" | 1 3/32" |
| 05022062001 | 6,0 | 180 | 32 | 7 1/16" | 1 1/4" |
| 05022063001 | 7,0 | 190 | 34 | 7 1/2" | 1 5/16" |
| 05022064001 | 8,0 | 200 | 36 | 8" | 1 7/16" |
| 05022066001 | 10,0 | 219 | 40 | 8 11/16" | 1 9/16" |
| 05022067001 | 12,0 | 248 | 45 | 10" | 1 3/4" |

¹⁾ Regular hexagon



950 SPKL L-key Multicolour, imperial



Application: Hexagon socket screws

Design: BlackLaser surface, durable plastic sleeve. The contrasting inscriptions on the colour-coded sleeves mean that it is easy to recognise the correct sizes and this makes it simpler to find the right tool.

Tip: Hex-Plus, ball-end hexagon on long arm

| | ⊙ | L ₁ | L ₂ | L ₃ | L ₄ |
|-------------|-------|----------------|----------------|----------------|----------------|
| | | mm | mm | | |
| 05022630001 | 5/64" | 101 | 16 | 4" | 5/8" |
| 05022631001 | 3/32" | 112 | 19 | 4 7/16" | 3/4" |
| 05022632001 | 1/8" | 123 | 21 | 4 7/8" | 27/32" |
| 05022633001 | 5/32" | 137 | 24 | 5 3/8" | 1" |
| 05022634001 | 3/16" | 154 | 27 | 6 1/16" | 1 1/16" |
| 05022635001 | 7/32" | 172 | 31 | 6 3/4" | 1 1/4" |
| 05022636001 | 1/4" | 185 | 34 | 7 1/4" | 1 5/16" |
| 05022637001 | 5/16" | 195 | 37 | 7 11/16" | 1 7/16" |
| 05022638001 | 3/8" | 224 | 42 | 9" | 1 11/16" |

950 PKL BM L-key, metric, BlackLaser



Application: Hexagon socket screws

Design: BlackLaser surface

Tip: Hex-Plus, ball-end hexagon on long arm

| | ⊙ | L ₁ | L ₂ | L ₃ | L ₄ |
|---------------------------|------|----------------|----------------|----------------|----------------|
| | mm | mm | mm | | |
| 05027101001 ¹⁾ | 1,5 | 90 | 14 | 3 1/2" | 9/16" |
| 05027102001 | 2,0 | 100 | 16 | 4" | 5/8" |
| 05027103001 | 2,5 | 112 | 18 | 4 7/16" | 23/32" |
| 05027104001 | 3,0 | 126 | 19 | 5" | 3/4" |
| 05027105001 | 4,0 | 140 | 25 | 5 1/2" | 1" |
| 05027106001 | 5,0 | 160 | 28 | 6 5/16" | 1 3/32" |
| 05027107001 | 6,0 | 180 | 32 | 7 1/16" | 1 1/4" |
| 05027110001 | 7,0 | 190 | 34 | 7 1/2" | 1 5/16" |
| 05027108001 | 8,0 | 200 | 36 | 8" | 1 7/16" |
| 05027109001 | 10,0 | 219 | 40 | 8 11/16" | 1 9/16" |
| 05027111001 | 12,0 | 248 | 45 | 10" | 1 3/4" |

¹⁾ Regular hexagon

L-Keys for Hexagon Socket Screws

The Hex-Plus profile extends the service life of hexagon socket screws

950 PKL L-key, imperial, BlackLaser



Application: Hexagon socket screws

Design: BlackLaser surface

Tip: Hex-Plus, ball-end hexagon on long arm

| | ⊙ | L ₁ mm | L ₂ mm | L ₃ " | L ₄ " |
|---------------------------|-------|----------------------|----------------------|---------------------|---------------------|
| 05022079001 ¹⁾ | 0,05" | 83 | 14 | 3 1/4" | 9/16" |
| 05022081001 ¹⁾ | 1/16" | 91 | 15 | 3 1/2" | 19/32" |
| 05022068001 | 5/64" | 100 | 16 | 4" | 5/8" |
| 05022070001 | 3/32" | 112 | 18 | 4 7/16" | 23/32" |
| 05022071001 | 7/64" | 119 | 19 | 4 3/4" | 3/4" |
| 05022072001 | 1/8" | 126 | 20 | 5" | 25/32" |
| 05022073001 | 9/64" | 132 | 23 | 5 3/16" | 29/32" |
| 05022074001 | 5/32" | 140 | 25 | 5 1/2" | 1" |
| 05022076001 | 3/16" | 160 | 25 | 6 5/16" | 1" |
| 05022078001 | 7/32" | 180 | 27 | 7 1/16" | 1 1/16" |
| 05022080001 | 1/4" | 190 | 34 | 7 7/2" | 1 5/16" |
| 05022082001 | 5/16" | 200 | 36 | 8" | 1 7/16" |
| 05022095001 | 3/8" | 212 | 38 | 8 3/8" | 1 1/2" |
| 05022096001 | 1/2" | 224 | 40 | 9" | 1 9/16" |

¹⁾ Regular hexagon

950 PKS L-key, metric, chrome-plated



Application: Hexagon socket screws

Design: Short, chrome-plated

Tip: Hex-Plus, ball-end hexagon on long arm

| | ⊙ | L ₁ mm | L ₂ mm | L ₃ mm | L ₄ " |
|---------------------------|------|----------------------|----------------------|----------------------|---------------------|
| 05133150001 ¹⁾ | 1,5 | 50 | 14 | 2" | 9/16" |
| 05133151001 | 2,0 | 56 | 16 | 2 7/32" | 5/8" |
| 05133152001 | 2,5 | 63 | 18 | 2 1/2" | 23/32" |
| 05133153001 | 3,0 | 71 | 20 | 2 3/4" | 25/32" |
| 05133154001 | 4,0 | 80 | 22 | 3" | 29/32" |
| 05133155001 | 5,0 | 90 | 25 | 3 1/2" | 1" |
| 05133156001 | 6,0 | 100 | 28 | 4" | 1 3/32" |
| 05133157001 | 8,0 | 112 | 32 | 4 7/16" | 1 1/4" |
| 05133158001 | 10,0 | 125 | 36 | 5" | 1 5/16" |

¹⁾ Regular hexagon

950 PKLS Long Arm Ballpoint Hex Key, metric, chrome plated



Application: For hexagon socket screws

Design: Chrome plated, with extra short arm for use on screws that are difficult to access

Tip: Hex-Plus, ballpoint hexagon on long arm

| | ⊙ mm | L ₁ mm | L ₂ mm | L ₃ mm | L ₄ " |
|---------------------------|---------|----------------------|----------------------|----------------------|---------------------|
| 05022040001 ¹⁾ | 1,5 | 90 | 4,5 | 3 1/2" | 11/64" |
| 05022041001 | 2,0 | 100 | 5,5 | 4" | 7/32" |
| 05022042001 | 2,5 | 112 | 6,5 | 4 7/16" | 1/4" |
| 05022043001 | 3,0 | 126 | 7,5 | 5" | 19/64" |
| 05022044001 | 4,0 | 140 | 10,0 | 5 1/2" | 25/64" |
| 05022045001 | 5,0 | 160 | 12 | 6 5/16" | 15/32" |
| 05022046001 | 6,0 | 180 | 15 | 7 1/16" | 19/32" |
| 05022047001 | 8,0 | 200 | 19 | 8" | 3/4" |
| 05022048001 | 10,0 | 219 | 22 | 8 5/8" | 7/8" |

¹⁾ Regular hexagon

950 L-key, metric, chrome-plated



Application: Hexagon socket screws

Design: Chrome-plated

Tip: Hex-Plus

| | ⊙ | L ₁ mm | L ₂ mm | L ₃ mm | L ₄ " |
|---------------------------|------|----------------------|----------------------|----------------------|---------------------|
| 05021600001 ¹⁾ | 1,5 | 90 | 14 | 3 1/2" | 9/16" |
| 05021605001 | 2,0 | 100 | 16 | 4" | 5/8" |
| 05021610001 | 2,5 | 112 | 18 | 4 7/16" | 23/32" |
| 05021615001 | 3,0 | 126 | 20 | 5" | 25/32" |
| 05021620001 | 4,0 | 140 | 25 | 5 1/2" | 1" |
| 05021625001 | 5,0 | 160 | 28 | 6 5/16" | 1 3/32" |
| 05021630001 | 6,0 | 180 | 32 | 7 1/16" | 1 1/4" |
| 05021632001 | 7,0 | 190 | 30 | 7 1/2" | 1 1/4" |
| 05021635001 | 8,0 | 200 | 36 | 8" | 1 7/16" |
| 05021640001 | 10,0 | 219 | 40 | 8 11/16" | 1 9/16" |
| 05021645001 | 12,0 | 250 | 45 | 10" | 1 3/4" |

¹⁾ Regular hexagon

950 L-key, metric, chrome-plated



Application: Hexagon socket screws
Design: Chrome-plated
Tip: Hex-Plus

| | ⊙ mm | L ₁ mm | L ₂ mm | L ₃ mm | L ₄ mm |
|---------------------------|---------|----------------------|----------------------|----------------------|----------------------|
| 05021005001 ¹⁾ | 1,5 | 45 | 14 | 1 3/4" | 9/16" |
| 05021010001 | 2,0 | 50 | 16 | 2" | 5/8" |
| 05021015001 | 2,5 | 56 | 18 | 2 7/32" | 23/32" |
| 05021020001 | 3,0 | 63 | 20 | 2 1/2" | 25/32" |
| 05021025001 | 3,5 | 66 | 23 | 2 5/8" | 29/32" |
| 05021030001 | 4,0 | 70 | 25 | 2 3/4" | 1" |
| 05021035001 | 4,5 | 75 | 26 | 3" | 1 1/32" |
| 05021040001 | 5,0 | 80 | 28 | 3 1/8" | 1 3/32" |
| 05021045001 | 6,0 | 90 | 32 | 3 1/2" | 1 1/4" |
| 05021050001 | 7,0 | 95 | 34 | 3 3/4" | 1 5/16" |
| 05021055001 | 8,0 | 100 | 36 | 4" | 1 7/16" |
| 05021060001 | 9,0 | 106 | 38 | 4 3/16" | 1 1/2" |
| 05021065001 | 10,0 | 112 | 40 | 4 7/16" | 1 9/16" |
| 05021070001 | 11,0 | 120 | 43 | 4 3/4" | 1 11/16" |
| 05021075001 | 12,0 | 125 | 45 | 5" | 1 3/4" |
| 05021080001 | 13,0 | 132 | 50 | 5 3/16" | 2" |
| 05021085001 ¹⁾ | 14,0 | 140 | 56 | 5 1/2" | 2 7/32" |
| 05021090001 ¹⁾ | 17,0 | 160 | 63 | 6 5/16" | 2 1/2" |
| 05021095001 ¹⁾ | 19,0 | 180 | 70 | 7 1/16" | 2 3/4" |
| 05021100001 ¹⁾ | 22,0 | 200 | 80 | 8" | 3 1/8" |
| 05021105001 ¹⁾ | 24,0 | 224 | 90 | 9" | 3 1/2" |
| 05021110001 ¹⁾ | 27,0 | 250 | 100 | 10" | 4" |

¹⁾ Regular hexagon.

950 BM L-key, metric, BlackLaser



Application: Hexagon socket screws
Design: BlackLaser surface
Tip: Hex-Plus

| | ⊙ mm | L ₁ mm | L ₂ mm | L ₃ mm | L ₄ mm |
|---------------------------|---------|----------------------|----------------------|----------------------|----------------------|
| 05027201001 ¹⁾ | 1,5 | 45 | 14 | 1 3/4" | 9/16" |
| 05027202001 | 2,0 | 50 | 16 | 2" | 5/8" |
| 05027203001 | 2,5 | 56 | 18 | 2 7/32" | 23/32" |
| 05027204001 | 3,0 | 63 | 20 | 2 1/2" | 25/32" |
| 05027205001 | 3,5 | 66 | 23 | 2 5/8" | 29/32" |
| 05027206001 | 4,0 | 70 | 25 | 2 3/4" | 1" |
| 05027207001 | 4,5 | 75 | 26 | 3" | 1 1/32" |
| 05027208001 | 5,0 | 80 | 28 | 3 1/8" | 1 3/32" |
| 05027209001 | 6,0 | 90 | 32 | 3 1/2" | 1 1/4" |
| 05027210001 | 7,0 | 95 | 34 | 3 3/4" | 1 5/16" |
| 05027211001 | 8,0 | 100 | 36 | 4" | 1 7/16" |
| 05027213001 | 9,0 | 106 | 38 | 4 11/64" | 1 1/2" |
| 05027212001 | 10,0 | 112 | 40 | 4 7/16" | 1 9/16" |
| 05027214001 | 11,0 | 120 | 43 | 4 23/32" | 1 11/16" |
| 05027215001 | 12,0 | 125 | 45 | 5" | 1 49/64" |

¹⁾ Regular hexagon.



L-Keys for TORX® Screws

Powerful, ergonomic, long service life

967/9 TX XL Multicolour HF 1 L-key set with holding function, long



9-piece set in a two-component clip

Application: TORX® socket screws

Blade: Zinc-phosphated, durable plastic sleeve. The contrasting inscriptions on the colour-coded sleeves mean that it is easy to recognise the correct sizes and this makes it simpler to find the right tool.

Design: Holding function for TORX® screws made according to Acument Intellectual Properties specifications

| | | |
|-------------|----|---|
| 05024470001 | | |
| | ♻️ | 967 SXL 1 x TX 8x90; 1 x TX 9x101; 1 x TX 10x112; |
| | | HF TORX® 1 x TX 15x123; 1 x TX 20x137; 1 x TX 25x154; |
| | | Multicolour 1 x TX 27x172; 1 x TX 30x195; 1 x TX 40x224 |

967/9 TX XL HF 1 L-key set with holding function, long



9-piece set in a two-component clip

Application: TORX® socket screws

Blade: zinc-phosphated

Design: Holding function for TORX® screws made according to Acument Intellectual Properties specifications

| | | |
|-------------|----|---|
| 05024450001 | | |
| | ♻️ | 967 XL HF 1 x TX 8x90; 1 x TX 9x101; 1 x TX 10x112; |
| | | TORX® 1 x TX 15x123; 1 x TX 20x137; 1 x TX 25x154; |
| | | 1 x TX 27x172; 1 x TX 30x195; 1 x TX 40x224 |

967/9 TX Multicolour HF 1 L-key set with holding function



9-piece set in a two-component clip

Application: TORX® socket screws

Blade: Round

Design: Holding function for TORX® screws made according to Acument Intellectual Properties specifications, BlackLaser surface, durable plastic sleeve. The contrasting inscriptions on the colour-coded sleeves mean that it is easy to recognise the correct sizes and this makes it simpler to find the right tool.

| | | |
|-------------|----|--|
| 05024179001 | | |
| | ♻️ | 967 SL TORX® 1 x TX 8x76; 1 x TX 9x79; 1 x TX 10x85; |
| | | HF 1 x TX 15x90; 1 x TX 20x96; 1 x TX 25x104; |
| | | 1 x TX 27x112; 1 x TX 30x122; 1 x TX 40x132 |

967/9 TX HF 1 L-key set with holding function, BlackLaser



9-piece set in a two-component clip

Application: TORX® socket screws

Blade: Round

Design: Holding function for TORX® screws made according to Acument Intellectual Properties specifications, BlackLaser surface

| | | |
|-------------|----|---|
| 05024244001 | | |
| | ♻️ | 967 L TORX® 1 x TX 8x76; 1 x TX 9x79; 1 x TX 10x85; |
| | | HF 1 x TX 15x90; 1 x TX 20x96; 1 x TX 25x104; |
| | | 1 x TX 27x112; 1 x TX 30x122; 1 x TX 40x132 |

967/9 TX XL Multicolour 1 Multicolour L-key set for TORX® screws, long



9-piece set in a two-component clip

Application: TORX® socket screws

Design: Zinc-phosphated, durable plastic sleeve. The contrasting inscriptions on the colour-coded sleeves mean that it is easy to recognise the correct sizes and this makes it simpler to find the right tool.

Tip: TORX® on short arm, TORX® ball end on long arm, TX 8, TX 9, TX 10: without ball-end at the long arm

| | | |
|-------------|--|---|
| 05024480001 | | |
| | 967 SXL TORX® Multicolour | 1 x TX 8x90; 1 x TX 9x101; 1 x TX 10x112 |
| | 967 SPKXL TORX® Multicolour | 1 x TX 15x123; 1 x TX 20x137; 1 x TX 25x154; 1 x TX 27x172; 1 x TX 30x195; 1 x TX 40x224 |

Tip



The HF profile

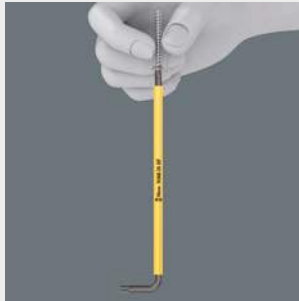

In tight assembly or disassembly situations, for example in engine compartments, it is not possible to securely hold the screw with the hand on the screwdriver, and the screw subsequently often gets lost. Lengthy searches or the loss of the screw (with the associated danger that could bring about) are the consequence. The HF tools

developed by Wera are ideal because they feature an optimised geometry of the original TORX® profile. The wedging forces resulting from the surface pressure between the drive tip and the screw profile mean that the screw is securely held on the tool!



“Take it easy”



“Take it easy” tool finder system – with profile and size colour-coding for quick and easy tool selection. Colour-coded system for hexagon drive screws (L-Keys, Zyklop bit sockets), external hex drive screws and nuts (Joker wrenches, Zyklop sockets and Zyklop bit sockets with holding function), and TORX® drive screws (L-Keys, Zyklop bit sockets).



L-Keys for TORX® Screws

Powerful, ergonomic, long service life

967/9 TX BO Multicolour 1 L-key set for tamper-proof TORX® screws, BlackLaser



9-piece set in a two-component clip. For recessed screws, it's often advantageous for the screw to be held on the L-key by magnetic force. The Wera clips with magnetiser/demagnetiser enable a magnetisation/demagnetisation of L-keys in a flash.

Application: TORX® socket screws with and without pin (BO = bore hole)

Design: BlackLaser, durable plastic sleeve. The contrasting inscriptions on the colour-coded sleeves mean that it is easy to recognise the correct sizes and this makes it simpler to find the right tool.

Tip: TORX® on short arm, TORX® ball end on long arm

| | | |
|-------------|------|---|
| 05024335001 | | |
| | ♻️♻️ | 967 SPKL 1 x TX 8x76 ¹⁾ ; 1 x TX 9x79 ¹⁾ ; 1 x TX 10x85 ²⁾ ; TORX® BO 1 x TX 15x90; 1 x TX 20x96; 1 x TX 25x104; Multicolour 1 x TX 27x112; 1 x TX 30x122; 1 x TX 40x132 |

¹⁾ Product without bore hole at the short and without ball-end at the long arm.
²⁾ Product without ball-end at the long arm.

967/9 TX BO Multicolour 1 SB, TORX® BO L-key set for tamper-proof TORX® screws, BlackLaser

| | | |
|-------------|------|---|
| | | 4013288 |
| 05073599001 | | 170125 |
| | ♻️♻️ | 967 SPKL TORX® BO Multicolour 1 x TX 8x76 ¹⁾ ; 1 x TX 9x79 ¹⁾ ; 1 x TX 10x85 ²⁾ ; 1 x TX 15x90; 1 x TX 20x96; 1 x TX 25x104; 1 x TX 27x112; 1 x TX 30x122; 1 x TX 40x132 |



¹⁾ Product without bore hole at the short and without ball-end at the long arm.
²⁾ Product without ball-end at the long arm.

967/9 TX XL 1 TORX® L-key set, long



9-piece set in a two-component clip

Application: TORX® socket screws

Design: Zinc-phosphated

Tip: TORX® on short arm, TORX® ball end on long arm, TX 8, TX 9, TX 10: without ball-end at the long arm

| | | |
|-------------|------|--|
| 05024460001 | | |
| | ♻️♻️ | 967 XL TORX® 1 x TX 8x90; 1 x TX 9x101; 1 x TX 10x112 |
| | ♻️♻️ | 967 PKXL TORX® 1 x TX 15x123; 1 x TX 20x137; 1 x TX 25x154; 1 x TX 27x172; 1 x TX 30x195; 1 x TX 40x224 |

967/9 TX 1 L-key set, BlackLaser



9-piece set in a two-component clip

Application: TORX® socket screws

Design: BlackLaser surface

Tip: TORX® on short arm, TORX® ball end on long arm

| | | |
|-------------|------|---|
| 05024242001 | | |
| | ♻️♻️ | 967 PKL TORX® 1 x TX 8x76 ¹⁾ ; 1 x TX 9x79 ¹⁾ ; 1 x TX 10x85 ¹⁾ ; 1 x TX 15x90; 1 x TX 20x96; 1 x TX 25x104; 1 x TX 27x112; 1 x TX 30x122; 1 x TX 40x132 |

¹⁾ Product without ball-end at the long arm.

967/9 TX 1 SB L-key set, BlackLaser

| | | |
|-------------|------|--|
| | | 4013288 |
| 05073598001 | | 106438 |
| | ♻️♻️ | 967 PKL TORX® 1 x TX 8x76 ¹⁾ ; 1 x TX 9x79 ¹⁾ ; 1 x TX 10x85 ¹⁾ ; 1 x TX 15x90; 1 x TX 20x96; 1 x TX 25x104; 1 x TX 27x112; 1 x TX 30x122; 1 x TX 40x132 |



¹⁾ Product without ball-end at the long arm.

967 SXL HF TORX® L-key Multicolour with holding function, long



Application: TORX® socket screws

Design: zinc-phosphated, durable plastic sleeve. The contrasting inscriptions on the colour-coded sleeves mean that it is easy to recognise the correct sizes and this makes it simpler to find the right tool.

Tip: Holding function for TORX® screws made according to Acument Intellectual Properties specifications

| | | mm | mm | | |
|-------------|-------|-----|----|----------|----------|
| 05024471001 | TX 8 | 90 | 16 | 3 1/2" | 5/8" |
| 05024472001 | TX 9 | 101 | 16 | 4" | 5/8" |
| 05024473001 | TX 10 | 112 | 19 | 4 7/16" | 3/4" |
| 05024474001 | TX 15 | 123 | 21 | 4 7/8" | 27/32" |
| 05024475001 | TX 20 | 137 | 24 | 5 3/8" | 1" |
| 05024476001 | TX 25 | 154 | 27 | 6 1/16" | 1 1/16" |
| 05024477001 | TX 27 | 172 | 31 | 6 3/4" | 1 1/4" |
| 05024478001 | TX 30 | 195 | 37 | 7 11/16" | 1 7/16" |
| 05024479001 | TX 40 | 224 | 42 | 9" | 1 11/16" |

967 SPKXL TORX® L-key Multicolour, long



Application: TORX® socket screws

Design: zinc-phosphated, durable plastic sleeve. The contrasting inscriptions on the colour-coded sleeves mean that it is easy to recognise the correct sizes and this makes it simpler to find the right tool.

Tip: TORX® on short arm, TORX® ball end on long arm

| | | mm | mm | | |
|-------------|-------|-----|----|----------|----------|
| 05024484001 | TX 15 | 123 | 21 | 4 7/8" | 27/32" |
| 05024485001 | TX 20 | 137 | 24 | 5 3/8" | 1" |
| 05024486001 | TX 25 | 154 | 27 | 6 1/16" | 1 1/16" |
| 05024487001 | TX 27 | 172 | 31 | 6 3/4" | 1 1/4" |
| 05024488001 | TX 30 | 195 | 37 | 7 11/16" | 1 7/16" |
| 05024489001 | TX 40 | 224 | 42 | 9" | 1 11/16" |

Tip



The HF profile

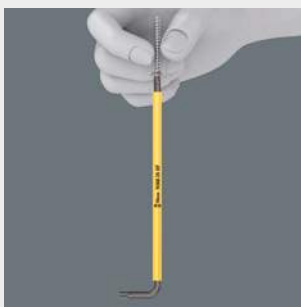

In tight assembly or disassembly situations, for example in engine compartments, it is not possible to securely hold the screw with the hand on the screwdriver, and the screw subsequently often gets lost. Lengthy searches or the loss of the screw (with the associated danger that could bring about) are the consequence. The HF tools

developed by Wera are ideal because they feature an optimised geometry of the original TORX® profile. The wedging forces resulting from the surface pressure between the drive tip and the screw profile mean that the screw is securely held on the tool!



"Take it easy"



"Take it easy" tool finder system – with profile and size colour-coding for quick and easy tool selection. Colour-coded system for hexagon drive screws (L-Keys, Zyklop bit sockets), external hex drive screws and nuts (Joker wrenches, Zyklop sockets and Zyklop bit sockets with holding function), and TORX® drive screws (L-Keys, Zyklop bit sockets).



Ball tip



The spherical drive profile means that it is possible to swivel the axis of the tool to that of the screw, and therefore enable angled, "around-the-corner" screwdriving jobs.

L-Keys for TORX® Screws

Powerful, ergonomic, long service life

967 SL TORX® HF L-key Multicolour with holding function



Application: TORX® socket screws

Blade: Round

Design: Holding function for TORX® screws made according to Acument Intellectual Properties specifications, BlackLaser, durable plastic sleeve. The contrasting inscriptions on the colour-coded sleeves mean that it is easy to recognise the correct sizes and this makes it simpler to find the right tool.

| | | L ₁ mm | L ₂ mm | L ₃ " | L ₄ " |
|-------------|-------|----------------------|----------------------|---------------------|---------------------|
| 05024170001 | TX 8 | 76 | 16 | 3" | 5/8" |
| 05024171001 | TX 9 | 79 | 16 | 3 1/8" | 5/8" |
| 05024172001 | TX 10 | 85 | 17 | 3 1/4" | 21/32" |
| 05024173001 | TX 15 | 90 | 18 | 3 1/2" | 23/32" |
| 05024174001 | TX 20 | 96 | 19 | 3 3/4" | 3/4" |
| 05024175001 | TX 25 | 104 | 21 | 4 1/8" | 27/32" |
| 05024176001 | TX 27 | 112 | 22 | 4 7/16" | 29/32" |
| 05024177001 | TX 30 | 122 | 24 | 4 13/16" | 1" |
| 05024178001 | TX 40 | 132 | 27 | 5 3/16" | 1 1/16" |

967 SPKL TORX® B0 L-key Multicolour



Application: TORX® socket screws with and without pin (B0 = bore hole)

Design: BlackLaser, durable plastic sleeve. The contrasting inscriptions on the colour-coded sleeves mean that it is easy to recognise the correct sizes and this makes it simpler to find the right tool.

Tip: TORX® on short arm, TORX® ball end on long arm

| | | L ₁ mm | L ₂ mm | L ₃ " | L ₄ " |
|---------------------------|-------|----------------------|----------------------|---------------------|---------------------|
| 05024350001 ¹⁾ | TX 8 | 76 | 16 | 3" | 5/8" |
| 05024351001 ¹⁾ | TX 9 | 79 | 16 | 3 1/8" | 5/8" |
| 05024352001 ²⁾ | TX 10 | 85 | 17 | 3 3/8" | 21/32" |
| 05024353001 | TX 15 | 90 | 18 | 3 1/2" | 23/32" |
| 05024354001 | TX 20 | 96 | 19 | 3 3/4" | 3/4" |
| 05024355001 | TX 25 | 104 | 21 | 4 1/8" | 27/32" |
| 05024356001 | TX 27 | 112 | 22 | 4 7/16" | 29/32" |
| 05024357001 | TX 30 | 122 | 24 | 4 13/16" | 1" |
| 05024358001 | TX 40 | 132 | 27 | 5 3/16" | 1 1/16" |

¹⁾ Product without bore hole at the short and without ball-end at the long arm.

²⁾ Product without ball-end at the long arm.

967 SXL TORX® L-key Multicolour, long



Application: TORX® socket screws

Design: zinc-phosphated, durable plastic sleeve. The contrasting inscriptions on the colour-coded sleeves mean that it is easy to recognise the correct sizes and this makes it simpler to find the right tool.

Tip: TORX®

| | | L ₁ mm | L ₂ mm | L ₃ " | L ₄ " |
|-------------|-------|----------------------|----------------------|---------------------|---------------------|
| 05024481001 | TX 8 | 90 | 16 | 3 1/2" | 5/8" |
| 05024482001 | TX 9 | 101 | 16 | 4" | 5/8" |
| 05024483001 | TX 10 | 112 | 19 | 4 7/16" | 3/4" |

967 XL HF TORX® L-key with holding function, long



Application: TORX® socket screws

Design: zinc-phosphated

Tip: Holding function for TORX® screws made according to Acument Intellectual Properties specifications

| | | L ₁ mm | L ₂ mm | L ₃ " | L ₄ " |
|-------------|-------|----------------------|----------------------|---------------------|---------------------|
| 05024451001 | TX 8 | 90 | 16 | 3 1/2" | 5/8" |
| 05024452001 | TX 9 | 101 | 16 | 4" | 5/8" |
| 05024453001 | TX 10 | 112 | 19 | 4 7/16" | 3/4" |
| 05024454001 | TX 15 | 123 | 21 | 4 7/8" | 27/32" |
| 05024455001 | TX 20 | 137 | 24 | 5 3/8" | 1" |
| 05024456001 | TX 25 | 154 | 27 | 6 1/16" | 1 1/16" |
| 05024457001 | TX 27 | 172 | 31 | 6 3/4" | 1 1/4" |
| 05024458001 | TX 30 | 195 | 37 | 7 11/16" | 1 7/16" |
| 05024459001 | TX 40 | 224 | 42 | 9" | 1 11/16" |



L-Keys for TORX® Screws

Powerful, ergonomic, long service life

967 PKXL TORX® L-key, long



Application: TORX® socket screws

Design: zinc-phosphated

Tip: TORX® on short arm, TORX® ball end on long arm

| | | L ₁ mm | L ₂ mm | L ₃ " | L ₄ " |
|-------------|-------|----------------------|----------------------|---------------------|---------------------|
| 05024464001 | TX 15 | 123 | 21 | 4 7/8" | 27/32" |
| 05024465001 | TX 20 | 137 | 24 | 5 3/8" | 1" |
| 05024466001 | TX 25 | 154 | 27 | 6 1/16" | 1 1/16" |
| 05024467001 | TX 27 | 172 | 31 | 6 3/4" | 1 1/4" |
| 05024468001 | TX 30 | 195 | 37 | 7 11/16" | 1 7/16" |
| 05024469001 | TX 40 | 224 | 42 | 9" | 1 1/16" |

967 XL TORX® L-key, lang



Application: TORX® socket screws

Design: zinc-phosphated

Tip: TORX®

| | | L ₁ mm | L ₂ mm | L ₃ " | L ₄ " |
|-------------|-------|----------------------|----------------------|---------------------|---------------------|
| 05024461001 | TX 8 | 90 | 16 | 3 1/2" | 5/8" |
| 05024462001 | TX 9 | 101 | 16 | 4" | 5/8" |
| 05024463001 | TX 10 | 112 | 19 | 4 7/16" | 3/4" |

967 PKL TORX® L-key, BlackLaser



Application: TORX® socket screws

Design: BlackLaser surface

Tip: TORX® on short arm, TORX® ball end on long arm

| | | L ₁ mm | L ₂ mm | L ₃ " | L ₄ " |
|---------------------------|-------|----------------------|----------------------|---------------------|---------------------|
| 05024199001 ¹⁾ | TX 8 | 76 | 16 | 3" | 5/8" |
| 05024100001 ¹⁾ | TX 9 | 79 | 16 | 3 1/8" | 5/8" |
| 05024105001 ¹⁾ | TX 10 | 85 | 17 | 3 3/8" | 21/32" |
| 05024200001 | TX 15 | 90 | 18 | 3 1/2" | 23/32" |
| 05024202001 | TX 20 | 96 | 19 | 3 3/4" | 3/4" |
| 05024204001 | TX 25 | 104 | 21 | 4 1/8" | 27/32" |
| 05024206001 | TX 27 | 112 | 22 | 4 7/16" | 29/32" |
| 05024208001 | TX 30 | 122 | 24 | 4 13/16" | 1" |
| 05024210001 | TX 40 | 132 | 27 | 5 3/16" | 1 1/16" |

¹⁾ Product without ball-end at the long arm.

967 L TORX® HF L-key with holding function, BlackLaser



Application: TORX® socket screws

Blade: Round, BlackLaser surface

Design: Holding function for TORX® screws made according to Acument Intellectual Properties specifications

| | | L ₁ mm | L ₂ mm | L ₃ " | L ₄ " |
|-------------|-------|----------------------|----------------------|---------------------|---------------------|
| 05024160001 | TX 8 | 76 | 16 | 3" | 5/8" |
| 05024161001 | TX 9 | 79 | 16 | 3 1/8" | 5/8" |
| 05024162001 | TX 10 | 85 | 17 | 3 1/4" | 21/32" |
| 05024163001 | TX 15 | 90 | 18 | 3 1/2" | 23/32" |
| 05024164001 | TX 20 | 96 | 19 | 3 3/4" | 3/4" |
| 05024165001 | TX 25 | 104 | 21 | 4 1/8" | 27/32" |
| 05024166001 | TX 27 | 112 | 22 | 4 7/16" | 29/32" |
| 05024167001 | TX 30 | 122 | 24 | 4 13/16" | 1" |
| 05024168001 | TX 40 | 132 | 27 | 5 3/16" | 1 1/16" |

967 TORX® L-key, BlackLaser



Application: TORX® socket screws

Design: BlackLaser surface

Tip: TORX®

| | | L ₁ mm | L ₂ mm | L ₃ " | L ₄ " |
|-------------|-------|----------------------|----------------------|---------------------|---------------------|
| 05024001001 | TX 6 | 42 | 16 | 1 5/8" | 5/8" |
| 05024002001 | TX 7 | 48 | 16 | 1 7/8" | 5/8" |
| 05024003001 | TX 8 | 48 | 16 | 1 7/8" | 5/8" |
| 05024004001 | TX 9 | 48 | 16 | 1 7/8" | 5/8" |
| 05024005001 | TX 10 | 51 | 17 | 2" | 21/32" |
| 05024008001 | TX 15 | 54 | 18 | 2 1/8" | 23/32" |
| 05024010001 | TX 20 | 57 | 19 | 2 1/4" | 3/4" |
| 05024012001 | TX 25 | 60 | 20 | 2 3/8" | 25/32" |
| 05024013001 | TX 27 | 64 | 21 | 2 1/2" | 27/32" |
| 05024015001 | TX 30 | 70 | 24 | 2 3/4" | 1" |
| 05024020001 | TX 40 | 76 | 26 | 3" | 1 1/32" |

Offset Screwdrivers

Suitable for slotted, Phillips and Pozidriv screws

919 PH Offset Screwdriver



Application: For Phillips screws
Blade: 90° + 180°, mat nickel

| | + | ┌ mm | ┌ mm | ┌ mm | ┌ mm |
|-------------|-------|---------|---------|---------|-------------------|
| 05017205001 | PH1+2 | 125 | 20 | 5" | $\frac{25}{32}$ " |

919 PZ Offset Screwdriver



Application: Suitable for Pozidriv-screws
Blade: 90° + 180°, BlackLaser

| | * | ┌ mm | ┌ mm | ┌ mm | ┌ mm |
|-------------|-------|---------|---------|---------|-------------------|
| 05017305001 | PZ1+2 | 125 | 20 | 5" | $\frac{25}{32}$ " |

920 A Offset Screwdriver













Application: For Slotted screws
Blade: 90° + 180°, mat nickel

| | ○ | ┌ mm | ┌ mm | ┌ mm | ┌ mm |
|-------------|---------|---------|---------|---------|-------------------|
| 05017405001 | 4,0+4,0 | 100 | 12 | 4" | $\frac{1}{2}$ " |
| 05017410001 | 5,5+5,5 | 125 | 16 | 5" | $\frac{5}{8}$ " |
| 05017415001 | 8,0+8,0 | 150 | 20 | 6" | $\frac{25}{32}$ " |





Kraftform Kompakt

| | | |
|---|---|------------|
|  | Kraftform Kompakt 10, 12 | 262 |
|  | Kraftform Kompakt 20, 22, 25, 26, 28 | 264 |
|  | Kraftform Kompakt 40, 41 | 268 |
|  | Kraftform Kompakt 50 | 269 |
|  | Kraftform Kompakt 60, 62 | 270 |
|  | Kraftform Kompakt 70, 71 | 276 |
|  | Kraftform Kompakt 100 | 278 |
|  | Kraftform Kompakt User Sets | 280 |
|  | Bitholding Screwdrivers and Adaptors | 284 |
|  | Kraftform Kompakt Vario With Ratchet Function | 288 |
|  | Kraftform Kompakt Vario Without Ratchet Function | 292 |



Kraftform Kompakt

Why is the right tool so often not at hand? The reason: too many tools and overly-heavy tool bags can make it bothersome to carry them onsite.

So for us it was a clear challenge: to design a tool that is suitable for a whole host of applications and can be easily taken along to jobs at other sites.

Our solution: Kraftform Kompakt tools. A handle into which blades with a range of different profiles can be inserted. Compactly and protectively housed in a light and robust textile pouch or plastic box.



The sets come with a Kraftform handle, quick-release chuck and bits for manual and power tool operations.



The handle/interchangeable blade system permits rapid exchange of the blades needed for a wide range of applications.



The tools can be stored and carried either in a solid plastic case or a robust pouch. In this way the tool is always to hand. Kraftform Kompakt Sets with Zyklop Speed or Zyklop Mini ratchet can be found on pages 146, 216-223.



Kraftform Kompakt user ranges – the new special sets – compact yet very versatile. Suitable for all sanitary, wood, metal or electrical applications.

Kraftform Kompakt 10, 12

A screwdriver set can hardly be more compact.

Kraftform Kompakt 10



10-piece set

1 bitholding screwdriver 813 R Kraftform with quick-release chuck Rapidaptor

| | | |
|-------------|----------------|--|
| 05056653001 | | |
| ● | 813 R | 1 x 1/4"x90 |
| + | 851/1 TZ PH | 1 x PH 1x25; 1 x PH 2x25 |
| + | 855/1 TZ PZ | 1 x PZ 1x25; 1 x PZ 2x25 |
| ⊕ | 867/1 TZ TORX® | 1 x TX 10x25; 1 x TX 15x25; 1 x TX 20x25 |
| ◐ | 800/1 TZ | 1 x 0,5x4,0x25; 1 x 1,0x5,5x25 |

Kraftform Kompakt 12



10-piece set

1 bitholding screwdriver 813 R Kraftform with quick-release chuck Rapidaptor

| | | |
|-------------|----------------|---|
| 05135942001 | | |
| ● | 813 R | 1 x 1/4"x90 |
| ⊕ | 867/1 TZ TORX® | 1 x TX 5x25; 1 x TX 6x25; 1 x TX 7x25; 1 x TX 8x25; 1 x TX 9x25 |
| + | 851/1 J | 1 x PH 00x25x2,0; 1 x PH 0x25x2,5; 1 x PH 1x25x3,0 |
| + | 851/1 TZ PH | 1 x PH 2x25 |

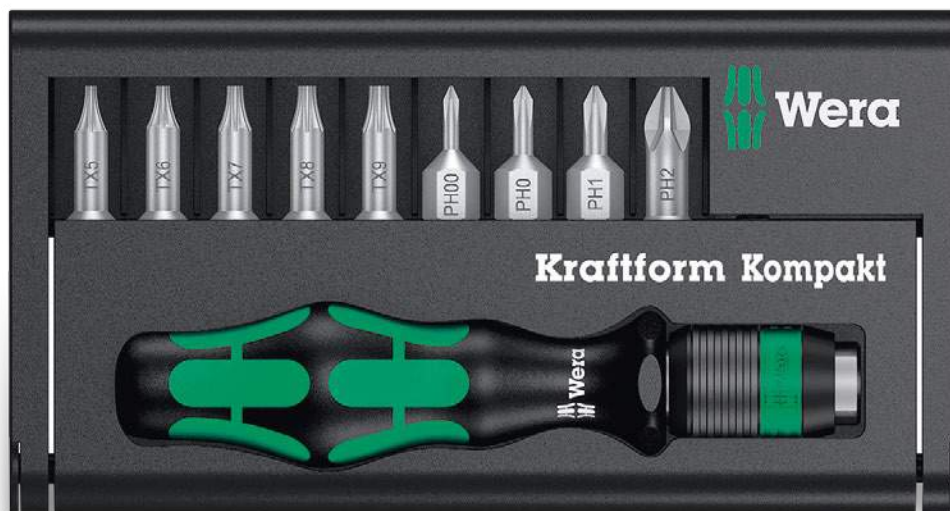



Kraftform Kompakt 20, 22, 25, 26, 28

Telescopic blade models

Kraftform Kompakt 20 A

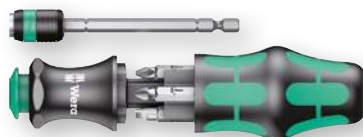

Application: Suitable for 1/4" DIN ISO 1173-C 6,3 and E 6,3 hexagon socket insert bits and Wera Series 1 and 4

Design: Attachment, telescopic, Rapidaptor rapid-in, rapid-out, rapid-spin, chuck-all and single-hand technology

Handle: Kraftform with non-roll feature, multi-component, integrated magazine

| | |
|-------------|--|
| 05051019001 | |
| ⊙ ⊙ | 889/4 R 1 x 1/4"x100 |
| + | 851/1 Z PH 1 x PH 1x25; 1 x PH 2x25 |
| + | 855/1 Z PZ 1 x PZ 1x25; 1 x PZ 2x25 |
| ⊖ | 800/1 Z 1 x 1,0x5,5x25; 1 x 1,2x6,5x25 |

Kraftform Kompakt 20 with pouch



Application: Suitable for 1/4" DIN ISO 1173-C 6,3 and E 6,3 hexagon socket insert bits and Wera Series 1 and 4

Design: Attachment, telescopic, Rapidaptor rapid-in, rapid-out, rapid-spin, chuck-all and single-hand technology

Handle: Kraftform with non-roll feature, multi-component, integrated magazine

| | |
|-------------|--|
| 05051021001 | |
| ⊙ ⊙ | 889/4 R 1 x 1/4"x100 |
| + | 851/1 Z PH 1 x PH 1x25; 1 x PH 2x25 |
| + | 855/1 Z PZ 1 x PZ 1x25; 1 x PZ 2x25 |
| ⊖ | 800/1 Z 1 x 1,0x5,5x25; 1 x 1,2x6,5x25 |

Kraftform Kompakt 20 Tool Finder 1 with pouch



Application: Suitable for 1/4" DIN ISO 1173-C 6.3 and E 6.3 hexagon socket insert bits and Wera Series 1 and 4

Design: Attachment, telescopic, Rapidaptor rapid-in, rapid-out, rapid-spin, chuck-all and single-hand technology; Take it easy toolfinder: Output colour coding and large stamp to enable the desired bit to be easily located

Handle: Kraftform with non-roll feature, multi-component, integrated magazine

| | |
|-------------|---------------------------------------|
| 05051016001 | |
| ⊙ ⊙ | 889/4 R 1 x 1/4"x100 |
| + | 851/1 BTZ PH 1 x PH 1x25; 1 x PH 2x25 |
| + | 855/1 BTZ PZ 1 x PZ 1x25; 1 x PZ 2x25 |
| ⊕ | 867/1 TORX® 1 x TX 25x25 BTZ |
| ⊖ | 800/1 BTZ 1 x 0,8x5,5x25 |

Kraftform Kompakt 22 with pouch



Application: Suitable for 1/4" DIN ISO 1173-C 6,3 and E 6,3 hexagon socket insert bits and Wera Series 1 and 4

Design: Attachment, telescopic, Rapidaptor rapid-in, rapid-out, rapid-spin, chuck-all and single-hand technology

Handle: Kraftform with non-roll feature, multi-component, integrated magazine

| | |
|-------------|--|
| 05051023001 | |
| ⊙ ⊙ | 889/4 R 1 x 1/4"x100 |
| + | 855/1 Z PZ 1 x PZ 1x25; 2 x PZ 2x25 |
| ⊕ | 867/1 Z TORX® 1 x TX 15x25; 1 x TX 20x25; 1 x TX 25x25 |



Kraftform Kompakt 20, 22, 25, 26, 28

Telescopic blade models

Kraftform Kompakt 25 with pouch



Application: Suitable for 1/4" DIN ISO 1173-C 6,3 and E 6,3 hexagon socket insert bits and Wera Series 1 and 4

Design: Attachment, telescopic, Rapidaptor rapid-in, rapid-out, rapid-spin, chuck-all and single-hand technology

Handle: Kraftform with non-roll feature, multi-component, integrated magazine

| | |
|-------------|--|
| 05051024001 | |
| ● ○ | 889/4 R 1 x 1/4"x100 |
| ⊕ | 851/1 Z PH 1 x PH 1x25; 1 x PH 2x25; 1 x PH 3x25 |
| ● | 800/1 Z 1 x 0,6x4,5x25; 1 x 1,0x5,5x25; 1 x 1,2x6,5x25 |

Kraftform Kompakt 26 with pouch



Application: Suitable for 1/4" DIN ISO 1173-C 6,3 and E 6,3 hexagon socket insert bits and Wera Series 1 and 4

Design: Attachment, telescopic, Rapidaptor rapid-in, rapid-out, rapid-spin, chuck-all and single-hand technology

Handle: Kraftform with non-roll feature, multi-component, integrated magazine

| | |
|-------------|--|
| 05051025001 | |
| ● ○ | 889/4 R 1 x 1/4"x100 |
| ⊕ | 851/1 Z PH 1 x PH 1x25; 1 x PH 2x25 |
| ● | 800/1 Z 1 x 1,0x5,5x25; 1 x 1,2x6,5x25 |
| ○ | 868/1 Z 1 x # 1x25; 1 x # 2x25 |

Kraftform Kompakt 28 SB



Application: Suitable for 1/4" DIN ISO 1173-C 6,3 hexagon socket insert bits and Wera Series 1

Design: Attachment, telescopic, with stainless steel sleeve, retaining ring, and strong permanent magnet

Handle: Kraftform with non-roll feature, multi-component, integrated magazine

| | |
|-------------|--|
| | |
| 05073240001 | |
| | 851/1 Z PH 1 x PH 1x25; 1 x PH 2x25 |
| | 855/1 Z PZ 1 x PZ 1x25; 1 x PZ 2x25 |
| | 800/1 Z 1 x 1,0x5,5x25; 1 x 1,2x6,5x25 |

Kraftform Kompakt 28 with pouch



Application: Suitable for 1/4" DIN ISO 1173-C 6,3 hexagon socket insert bits and Wera Series 1

Design: Attachment, telescopic, with stainless steel sleeve, retaining ring, and strong permanent magnet

Handle: Kraftform with non-roll feature, multi-component, integrated magazine

| | |
|-------------|--|
| | |
| 05134491001 | |
| | 800/1 Z 1 x 1,0x5,5x25; 1 x 1,2x6,5x25 |
| | 851/1 Z PH 1 x PH 1x25; 1 x PH 2x25 |
| | 855/1 Z PZ 1 x PZ 1x25; 1 x PZ 2x25 |

Tip

Telescopic blade, integrated bit magazine, Rapidaptor technology



The sets in the series Kraftform Kompakt 20 are really something. A 2 position telescopic blade can be retracted into the handle for confined space operation or extended for more reach. It can also be removed and used as a 100mm bit holder in the power tool. Six bits are conveniently integrated into a push-button opening bit magazine.

The Rapidaptor technology ensures rapid one hand bit changes, press-in auto bit lock and a secure positioning when used in power tools thanks to the free-turning sleeve.



The telescopic blade



When the unique telescopic blade is lowered into the handle, fast, easy screw-driving action is possible, even in the tightest spots!

By pushing the clamping sleeve, the telescopic blade can be extended out of the handle and the compact tool becomes a full-sized screwdriver.



If the clamping sleeve is pushed again the telescopic blade can be taken out of the handle, and be used as a machine bit adaptor.



Kraftform Kompakt 40 and 41

Bits of 89 mm in length

Kraftform Kompakt 40



Pouch with 89 mm bits

7-piece set

1 Kraftform bitholding screwdriver 816 R with Rapidaptor quick-release chuck

| | | |
|-------------|------------|--------------------------------|
| 05059298001 | | |
| ● | 816 R | 1 x 1/4"x119 |
| ⊕ | 851/4 Z PH | 1 x PH 1x89; 1 x PH 2x89 |
| ⊕ | 855/4 Z PZ | 1 x PZ 1x89; 1 x PZ 2x89 |
| ● | 800/4 Z | 1 x 1,0x5,5x89; 1 x 1,2x6,5x89 |

Kraftform Kompakt 41



Pouch with 89 mm bits

11-piece set

1 Kraftform bitholding screwdriver 816 R with Rapidaptor quick-release chuck

| | | |
|-------------|------------------|--|
| 05059299001 | | |
| ● | 816 R | 1 x 1/4"x119 |
| ⊕ | 851/4 Z PH | 1 x PH 1x89; 1 x PH 2x89; 1 x PH 3x89 |
| ⊕ | 855/4 Z PZ | 1 x PZ 1x89; 1 x PZ 2x89; 1 x PZ 3x89 |
| ⊕ | 867/4 Z TORX® B0 | 1 x TX 15x89; 1 x TX 20x89; 1 x TX 25x89; 1 x TX 30x89 |

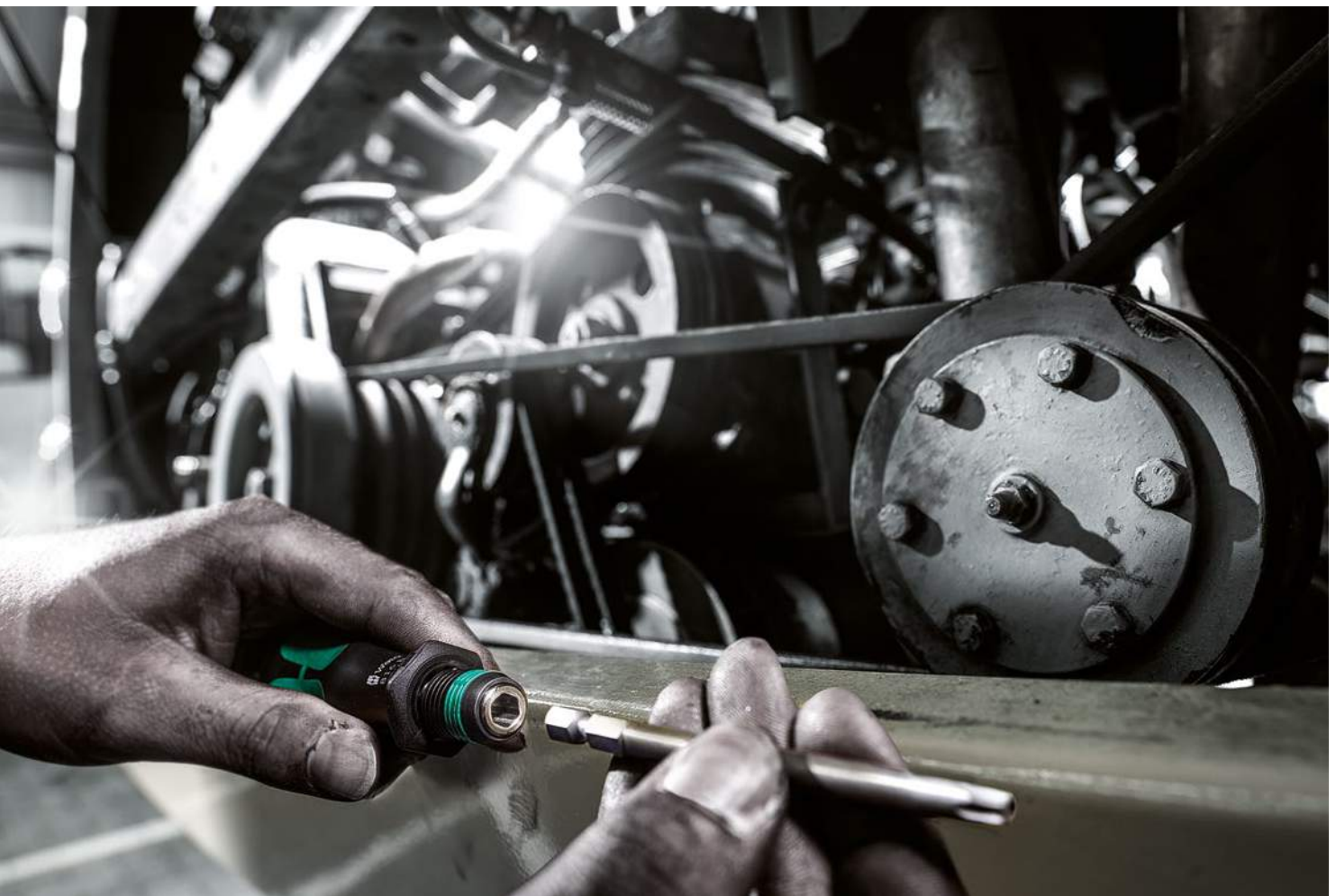

Kraftform Kompakt 50

Telescopic blade model

Kraftform Kompakt 50



14-piece set

1 Kraftform bitholding screwdriver 817 R and telescopic blade with quick-release chuck Rapidaptor

| 05056656001 | |
|-------------|--|
| ● | 817 R 1 x 1/4"x133 |
| ○ | 889/4 R 1 x 1/4"x100 |
| + | 851/1 Z PH 1 x PH 1x25; 1 x PH 2x25 |
| + | 855/1 Z PZ 1 x PZ 1x25; 1 x PZ 2x25 |
| ⊕ | 867/1 Z TORX® BO 1 x TX 10x25; 1 x TX 15x25; 1 x TX 20x25; 1 x TX 25x25; 1 x TX 30x25; 1 x TX 40x25 |
| ● | 800/1 Z 1 x 0,6x4,5x25; 1 x 1,0x5,5x25 |



Tip



The telescopic blade



When the unique telescopic blade is lowered into the handle, fast, easy screw-driving action is possible, even in the tightest spots!



By pushing the clamping sleeve, the telescopic blade can be extended out of the handle and the compact tool becomes a full-sized screwdriver.



If the clamping sleeve is pushed again the telescopic blade can be taken out of the handle, and be used as a machine bit adaptor.



Kraftform Kompakt 60, 62

Bits of 89 mm in length

Kraftform Kompakt 60 Torque 1.2 - 3.0 Nm



Pouch with 89 mm bits

17-piece set

1 Series 7400 Kraftform adjustable torque screwdriver (1.2-3.0 Nm) with Rapidaptor quick-release chuck

| | | |
|------------------|---|--|
| 05059293001 | | |
| 7400 | 1 x 7441x1/4"x1,2-3,0x155 | |
| 851/4 Z PH | 1 x PH 1x89; 1 x PH 2x89; 1 x PH 3x89 | |
| 855/4 Z PZ | 1 x PZ 1x89; 1 x PZ 2x89; 1 x PZ 3x89 | |
| 867/4 Z TORX® BO | 1 x TX 10x89; 1 x TX 15x89; 1 x TX 20x89; 1 x TX 25x89; 1 x TX 30x89 | |
| 800/4 Z | 1 x 1,0x5,5x89 | |
| 840/4 Z Hex-Plus | 1 x 3,0x89; 1 x 4,0x89; 1 x 5,0x89; 1 x 6,0x89 | |

Kraftform Kompakt 60, stainless



Pouch with 89 mm bits, stainless steel

17-piece set

1 Kraftform stainless bitholding screwdriver 3816 R with Rapidaptor quick-release chuck

| | | |
|-----------------|---|--|
| 05071116001 | | |
| 3816 R | 1 x 1/4"x119 | |
| 3851/4 | 1 x PH 1x89; 1 x PH 2x89; 1 x PH 3x89 | |
| 3855/4 | 1 x PZ 1x89; 1 x PZ 2x89; 1 x PZ 3x89 | |
| 3867/4 TORX® BO | 1 x TX 10 B0x89; 1 x TX 15 B0x89; 1 x TX 20 B0x89; 1 x TX 25 B0x89; 1 x TX 30 B0x89 | |
| 3800/4 | 1 x 1,0x5,5x89 | |
| 3840/4 Hex-Plus | 1 x 3,0x89; 1 x 4,0x89; 1 x 5,0x89; 1 x 6,0x89 | |







Kraftform Kompakt 60, imperial, stainless



Pouch with 89 mm bits, stainless steel

17-piece set

1 Kraftform stainless bitholding screwdriver 3816 R with Rapidaptor quick-release chuck

|  | | |
|---|---------------------------|---|
| 05071117001 | | |
|  | 3816 R | 1 x 1/4"x119 |
|  | 3851/4 | 1 x PH 1x89; 1 x PH 2x89; 1 x PH 3x89 |
|  | 3867/4 TORX® B0 | 1 x TX 10 B0x89; 1 x TX 15 B0x89; 1 x TX 20 B0x89; 1 x TX 25 B0x89; 1 x TX 30 B0x89 |
|  | 3800/4 | 1 x 1,0x5,5x89 |
|  | 3840/4 Hex-Plus | 1 x 3/32"x89; 1 x 1/8"x89; 1 x 5/32"x89; 1 x 3/16"x89 |
|  | 3868/4 Square-Plus | 1 x # 1x89; 1 x # 2x89; 1 x # 3x89 |

Tip



Adjustable torque screwdriver



Simple setting of the required torque by hand. Easy-to-read scale value.

Measurement accuracy is $\pm 6\%$ in accordance with the standard EN ISO 6789. Distinctly audible and noticeable excess-load signal when the pre-set torque is reached.



Vacuum ice-hardened



The stainless steel tools from Wera are vacuum ice-hardened and have the hardness and strength needed for screw connections. There are no limitations to the industrial applications they are suitable for.



Kraftform Kompakt 60, 62

Bits of 89 mm in length

Kraftform Kompakt 60



Pouch with 89 mm bits

17-piece set

1 Kraftform bitholding screwdriver 816 R with Rapidaptor quick-release chuck

| | | |
|-------------|------------------|---|
| 05059295001 | | |
| ● | 816 R | 1 x 1/4"x119 |
| + | 851/4 Z PH | 1 x PH 1x89; 1 x PH 2x89; 1 x PH 3x89 |
| + | 855/4 Z PZ | 1 x PZ 1x89; 1 x PZ 2x89; 1 x PZ 3x89 |
| ⊕ | 867/4 Z TORX® BO | 1 x TX 10x89; 1 x TX 15x89; 1 x TX 20x89; 1 x TX 25x89; 1 x TX 30x89 |
| ⊖ | 800/4 Z | 1 x 1,0x5,5x89 |
| ○ | 840/4 Z Hex-Plus | 1 x 3,0x89; 1 x 4,0x89; 1 x 5,0x89; 1 x 6,0x89 |

Kraftform Kompakt 60, imperial



Pouch with 89 mm bits

17-piece set

1 Kraftform bitholding screwdriver 816 R with Rapidaptor quick-release chuck

| | | |
|-------------|-------------------|---|
| 05051042001 | | |
| ● | 816 R | 1 x 1/4"x119 |
| + | 851/4 Z PH | 1 x PH 1x89; 1 x PH 2x89; 1 x PH 3x89 |
| ⊕ | 867/4 Z TORX® BO | 1 x TX 10x89; 1 x TX 15x89; 1 x TX 20x89; 1 x TX 25x89; 1 x TX 30x89 |
| ⊖ | 800/4 Z | 1 x 1,0x5,5x89 |
| ○ | 840/4 Z Hex-Plus | 1 x 3/32"x89; 1 x 1/8"x89; 1 x 5/32"x89; 1 x 3/16"x89 |
| ◻ | 868/4 Square-Plus | 1 x # 1x89; 1 x # 2x89; 1 x # 3x89 |

Kraftform Kompakt 60 KK



Pouch with 89 mm bits

17-piece set

1 Kraftform bitholding screwdriver 816 R with Rapidaptor quick-release chuck

| | | |
|-------------|------------|---|
| 05059294001 | | |
| ● | 816 R | 1 x 1/4"x119 |
| + | 851/4 Z PH | 1 x PH 1x89; 1 x PH 2x89; 1 x PH 3x89 |
| + | 855/4 Z PZ | 1 x PZ 1x89; 1 x PZ 2x89; 1 x PZ 3x89 |
| ⊕ | 867/4 KK | 1 x TX 10x89; 1 x TX 15x89; 1 x TX 20x89; 1 x TX 25x89; 1 x TX 30x89; 1 x TX 40x89 |
| ○ | 842/4 | 1 x 3,0x89; 1 x 4,0x89; 1 x 5,0x89; 1 x 6,0x89 |

Kraftform Kompakt 62



Pouch with 89 mm bits

33-piece set

1 Kraftform bitholding screwdriver 816 R with Rapidaptor quick-release chuck

| 05059297001 | | |
|-------------|-----------------------|---|
| ● | 816 R | 1 x 1/4"x119 |
| ⊕ | 857/4 Z Spanner | 1 x 4x89; 1 x 6x89; 1 x 8x89; 1 x 10x89 |
| + | 851/4 Z PH | 1 x PH 1x89; 1 x PH 2x89; 1 x PH 3x89 |
| + | 855/4 Z PZ | 1 x PZ 1x89; 1 x PZ 2x89; 1 x PZ 3x89 |
| ⊕ | 867/4 Z TORX® BO | 1 x TX 8x89; 1 x TX 10x89; 1 x TX 15x89; 1 x TX 20x89; 1 x TX 25x89; 1 x TX 27x89; 1 x TX 30x89; 1 x TX 40x89 |
| ⊖ | 800/4 Z | 1 x 1,2x6,5x89 |
| ⊕ | 840/4 Z Hex-Plus BO | 1 x 2,0x89; 1 x 2,5x89; 1 x 3,0x89; 1 x 4,0x89; 1 x 5,0x89; 1 x 6,0x89 |
| ⊕ | 871/4 TORQ-SET® Mplus | 1 x 6x89; 1 x 8x89; 1 x 10x89 |
| ⊕ | 875/4 TRI-WING® | 1 x 1x89; 1 x 2x89; 1 x 3x89; 1 x 4x89 |

Tip



Ball tip



The spherical drive profile means that it is possible to swivel the axis of the tool to that of the screw, and therefore enable angled, "around-the-corner" screwdriving jobs.

How can time wasted by using the wrong screwdriver be avoided?



Frequently, users have to work with their tools at a fixed workplace location as well as at external sites. Just as frequently, it is only on site that a decision is taken as to whether to work manually or with a power tool.

The Kraftform Kompakt tool sets equip the user for both types of operation with just one single set. Additionally, the sets are kept in belt pouches or plastic cases. This keeps them secure and clean and means that they are clearly arranged for easy tool selection, something that is very practical when they are to be used or transported.







Kraftform Kompakt 70 and 71

Kraftform handle, Rapidaptor and 30 bits

Kraftform Kompakt 70 universal



32-piece set

1 Kraftform bitholding screwdriver 816 R with Rapidaptor quick-release chuck,
1 universal bit holder 889/4/1 K Rapidaptor

| | | |
|-------------|------------------|---|
| 05057110001 | | |
| ● | 816 R | 1 x 1/4"x119 |
| ●○ | 889/4/1 K | 1 x 1/4"x50 |
| + | 851/1 TZ PH | 3 x PH 1x25; 3 x PH 2x25; 3 x PH 3x25 |
| + | 855/1 TZ PZ | 3 x PZ 1x25; 3 x PZ 2x25; 3 x PZ 3x25 |
| ⊕ | 867/1 Z TORX® BO | 1 x TX 10x25; 1 x TX 15x25; 1 x TX 20x25; 1 x TX 25x25; 1 x TX 30x25; 1 x TX 40x25 |
| ⊖ | 800/1 TZ | 1 x 0,6x4,5x25; 1 x 1,0x5,5x25; 1 x 1,2x6,5x25 |
| ○ | 840/1 Z Hex-Plus | 1 x 4,0x25; 1 x 5,0x25; 1 x 6,0x25 |

Kraftform Kompakt 71 security



32-piece set

1 Kraftform bitholding screwdriver 816 R with Rapidaptor quick-release chuck,
1 universal bit holder 889/4/1 K Rapidaptor

| | | |
|-------------|--------------------------------|---|
| 05057111001 | | |
| ● | 816 R | 1 x 1/4"x119 |
| ●○ | 889/4/1 K | 1 x 1/4"x50 |
| ⊕ | 867/1 Z TORX® BO | 1 x TX 7x25; 1 x TX 8x25; 1 x TX 9x25; 1 x TX 10x25; 1 x TX 15x25; 1 x TX 20x25; 1 x TX 25x25; 1 x TX 30x25; 1 x TX 40x25 |
| ⊖ | 840/1 Z Hex-Plus BO | 1 x 2,0x25; 1 x 2,5x25; 1 x 3,0x25; 1 x 4,0x25; 1 x 5,0x25; 1 x 6,0x25 |
| ○ | 868/1 Z | 1 x # 0x25; 1 x # 1x25; 1 x # 2x25; 1 x # 3x25 |
| + | 871/1 TORQ-SET® Mplus 25 mm | 1 x 6x25; 1 x 8x25; 1 x 10x25; 1 x 1/4"x25 |
| ▲ | 875/1 TRI-WING® 25 mm | 1 x 1x25; 1 x 2x25; 1 x 3x25 |
| ⊕ | 857/1 Z Spanner | 1 x 4x25; 1 x 6x25; 1 x 8x25; 1 x 10x25 |





SCHMIDLER
Produktions

Kraftform Kompakt 71
Drehbohrer
Drehbohrer

| Größe | Material |
|---------|----------|
| Ø 4,0 | 34PH1 |
| Ø 4,5 | 34PH2 |
| Ø 5,0 | 34PH3 |
| Ø 6,0 | 34PH4 |
| Ø 7,0 | 34PH5 |
| Ø 8,0 | 34PH6 |
| Ø 9,0 | 34PH7 |
| Ø 10,0 | 34PH8 |
| Ø 11,0 | 34PH9 |
| Ø 12,0 | 34PH10 |
| Ø 13,0 | 34PH11 |
| Ø 14,0 | 34PH12 |
| Ø 15,0 | 34PH13 |
| Ø 16,0 | 34PH14 |
| Ø 18,0 | 34PH15 |
| Ø 20,0 | 34PH16 |
| Ø 22,0 | 34PH17 |
| Ø 24,0 | 34PH18 |
| Ø 26,0 | 34PH19 |
| Ø 28,0 | 34PH20 |
| Ø 30,0 | 34PH21 |
| Ø 32,0 | 34PH22 |
| Ø 34,0 | 34PH23 |
| Ø 36,0 | 34PH24 |
| Ø 38,0 | 34PH25 |
| Ø 40,0 | 34PH26 |
| Ø 42,0 | 34PH27 |
| Ø 44,0 | 34PH28 |
| Ø 46,0 | 34PH29 |
| Ø 48,0 | 34PH30 |
| Ø 50,0 | 34PH31 |
| Ø 52,0 | 34PH32 |
| Ø 54,0 | 34PH33 |
| Ø 56,0 | 34PH34 |
| Ø 58,0 | 34PH35 |
| Ø 60,0 | 34PH36 |
| Ø 62,0 | 34PH37 |
| Ø 64,0 | 34PH38 |
| Ø 66,0 | 34PH39 |
| Ø 68,0 | 34PH40 |
| Ø 70,0 | 34PH41 |
| Ø 72,0 | 34PH42 |
| Ø 74,0 | 34PH43 |
| Ø 76,0 | 34PH44 |
| Ø 78,0 | 34PH45 |
| Ø 80,0 | 34PH46 |
| Ø 82,0 | 34PH47 |
| Ø 84,0 | 34PH48 |
| Ø 86,0 | 34PH49 |
| Ø 88,0 | 34PH50 |
| Ø 90,0 | 34PH51 |
| Ø 92,0 | 34PH52 |
| Ø 94,0 | 34PH53 |
| Ø 96,0 | 34PH54 |
| Ø 98,0 | 34PH55 |
| Ø 100,0 | 34PH56 |

FAKTE: 15.00
147.000.000.00



Kraftform Kompakt 100

Bits, Bit Holders and L-keys in one tool set

Kraftform Kompakt 100



52-piece set; in a surface-preserving, compact and extremely robust textile box; low volume and weight for simplified mobility.
 Compact tool set with 52 screwdriving tools. 1 hand holder Rapidaptor with quick-release chuck; 1 bit holder Rapidaptor with quick-release chuck; 30 BiTorsion bits (25 mm length) for long service life, tough (BTZ), for universal use, extra-hard (BTH), 12 Impaktor bits (50 mm length) for an above-average service life even under extreme conditions, 8 L-keys with Hex-Plus profile (reduces the notching effect that is damaging for the head of the screw) ball-end on long arm; extremely robust textile box, extremely robust, for long service life, can be stored in a spacesaving upright position; textile material for surface protection.

| | |
|-------------|---|
| 05057460001 | |
| ● | 813 R 1 x 1/4"x90 |
| ●○ | 889/4/1 K 1 x 1/4"x50 |
| + | 851/1 BTZ PH 2 x PH 1x25; 4 x PH 2x25; 2 x PH 3x25 |
| + | 851/4 IMP DC 2 x PH 2x50; 1 x PH 3x50 |
| + | 855/1 BTH PZ 2 x PZ 1x25; 4 x PZ 2x25; 2 x PZ 3x25 |
| + | 855/4 IMP DC 2 x PZ 2x50; 1 x PZ 3x50 |
| ⊕ | 867/1 TORX® 2 x TX 10x25; 2 x TX 15x25; 3 x TX 20x25; BTZ 2 x TX 25x25; 2 x TX 30x25; 1 x TX 40x25 |
| ⊕ | 867/4 IMP DC 1 x TX 25x50; 1 x TX 30x50; 1 x TX 40x50 |
| ● | 800/1 BTZ 1 x 0,8x5,5x25; 1 x 1,0x5,5x25 |
| ○ | 840/4 IMP DC 1 x 4,0x50; 1 x 5,0x50; 1 x 6,0x50 |
| ○ | 950 PKS 1 x 1,5x50 ¹⁾ ; 1 x 2,0x56; 1 x 2,5x63; 1 x 3,0x71; 1 x 4,0x80; 1 x 5,0x90; 1 x 6,0x100; 1 x 8,0x112 |

¹⁾ Regular hexagon



Kraftform Kompakt user-specific sets

Kraftform Kompakt W 1 Maintenance

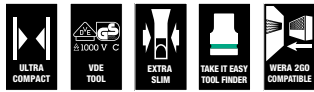

35-piece set; in surface-protecting, compact textile box, highly robust; low volume and weight for simplified mobility.

Compact tool set with the most important screwdriving tools for maintenance jobs both indoors as well as outdoors. VDE hand holder including 12 VDE blades; 1 Joker double open-ended wrench with holding function, limit stop, small return angle and extremely high-grip toothing; incl. the incredibly fast $\frac{1}{4}$ " Zyklop Speed ratchet with accessories; 8 manual and power tool sockets in the dimensions 5.5-13, 1 universal bit holder; 7 25mm bits; 1 screw gripper to firmly hold screws; 1 voltage tester 247; textile box that is very robust and durable; can be positioned upright in the workshop shelf for tidy storage; additional surface protection thanks to the textile outer material; low weight and volume for simplified mobility.

| | | |
|-------------|------------------|--|
| 05135926001 | | |
| ● | 817 VDE | 1 x 9x102 |
| ● | KK 60 i | 1 x 0,4x2,5x154 |
| ● | KK 60 iS | 1 x 0,6x3,5x154; 1 x 0,8x4,0x154; 1 x 1,0x5,5x154 |
| + | KK 62 iS | 1 x PH 1x154; 1 x PH 2x154 |
| + | KK 65 iS PZ | 1 x PZ 1x154; 1 x PZ 2x154 |
| + | KK 67 i TORX® | 1 x TX 10x154 |
| + | KK 67 iS TORX® | 1 x TX 15x154; 1 x TX 20x154; 1 x TX 25x154 |
| | 1440 | 1 x 4,5 - 6,0x41,0 |
| ● | 247 | 1 x 0,5x3,0x70 |
| | Joker Double | 1 x 10x13x167 |
| ○ | 8000 A | 1 x 1/4"x152,0 |
| ● | 8784 A1 | 1 x 1/4"x1/4"x37,0 |
| ● | 8794 SA | 1 x 1/4"x75,0 |
| ● | 8790 HMA | 1 x 5,5x23,0; 1 x 6,0x23,0; 1 x 7,0x23,0; 1 x 8,0x23,0; 1 x 10,0x23,0; 1 x 11,0x23,0; 1 x 12,0x23,0; 1 x 13,0x23,0 |
| ● | 893/4/1 K | 1 x 1/4"x50 |
| + | 855/1 Z PZ | 1 x PZ 1x25; 1 x PZ 2x25 |
| ○ | 840/1 Z Hex-Plus | 1 x 3,0x25; 1 x 4,0x25; 1 x 5,0x25; 1 x 6,0x25 |
| + | 867/1 Z TORX® | 1 x TX 25x25 |

Product not available in the USA and Canada.

Kraftform Kompakt H 1 Woodcraft



41-piece set; in surface-protecting, compact textile box, highly robust; low volume and weight for simplified mobility.

Compact tool set with the 41 most important screwdriving tools for jobs involving wood: including the robust Bit Ratchet Zyklop Mini with extension and socket adaptor; 8 manual and power tool sockets in the dimensions 5.5-13; 1 hand holder 816 RA with ratchet function, fine toothing for small return angle, switch-over ring (right, fixed, left), maximum torque 50 Nm and bit take-up with Rapidaptor technology; 1 universal bit holder; 6 bits of 25mm in length; 16 bits of 89 mm in length; 5 twist drill bits for wood with a diameter of 3-8mm; 1 screw gripper to firmly hold screws; 1 voltage tester 247.

| | | |
|-------------|------------------|---|
| 05135939001 | | |
| ● | 816 RA | 1 x 1/4"x142,0 |
| | 8001 A | 1 x 1/4"x87,0 |
| ○ | 870/1 | 1 x 1/4"x25 |
| ● | 8794 SA | 1 x 1/4"x75,0 |
| ● | 8790 HMA | 1 x 5,5x23,0; 1 x 6,0x23,0; 1 x 7,0x23,0; 1 x 8,0x23,0; 1 x 10,0x23,0; 1 x 12,0x23,0; 1 x 13,0x23,0 |
| ● | 893/4/1 K | 1 x 1/4"x50 |
| + | 851/4 Z PH | 1 x PH 1x89; 1 x PH 2x89; 1 x PH 3x89 |
| + | 855/4 Z PZ | 1 x PZ 1x89; 1 x PZ 2x89; 1 x PZ 3x89 |
| + | 855/1 Z PZ | 1 x PZ 1x25; 1 x PZ 2x25; 1 x PZ 3x25 |
| + | 867/4 Z TORX® | 1 x TX 10x89; 1 x TX 15x89; 1 x TX 20x89; 1 x TX 25x89; 1 x TX 30x89 |
| + | 867/1 Z TORX® | 1 x TX 20x25; 1 x TX 25x25 |
| ○ | 840/4 Z Hex-Plus | 1 x 3,0x89; 1 x 4,0x89; 1 x 5,0x89; 1 x 6,0x89 |
| ● | 800/4 Z | 1 x 1,0x5,5x89 |
| ● | 800/1 Z | 1 x 1,0x5,5x25 |
| + | 849 HSS | 1 x 3,0x70,0; 1 x 4,0x74,0; 1 x 5,0x85,0; 1 x 6,0x95,0; 1 x 8,0x110,0 |
| ● | 247 | 1 x 0,5x3,0x70 |
| | 1441 | 1 x 4,5 - 6,0x41,0 |

Product not available in the USA and Canada.

Kraftform Kompakt M 1 Metal



39-piece set; in surface-protecting, compact textile box, highly robust; low volume and weight for simplified mobility.

Compact tool set with the 39 most important screwdriving tools for jobs involving metal, including the incredibly fast $\frac{1}{4}$ " Zyklop Speed ratchet with accessories; 7 manual and power tool sockets in the dimensions 5.5-13; 1 bit hand holder; 13 bits of 89 mm in length; 6 combination screw tap bits; 6 twist drill bits for metal with a diameter of 3-10mm; 1 screw gripper to firmly hold screws; 1 voltage tester 247; textile box that is very robust and durable; can be positioned upright in the workshop shelf for tidy storage; additional surface protection thanks to the textile outer material; low weight and volume for simplified mobility.

| | | |
|-------------|------------------|---|
| 05135928001 | | |
| ⊕ | 8000 A | 1 x 1/4"x152,0 |
| ⊕ | 8794 LA | 1 x 1/4"x150,0 |
| ⊕ | 8794 A | 1 x 1/4"x56,0 |
| ⊕ | 8784 A1 | 1 x 1/4"x1/4"x37,0 |
| ⊕ | 816 R | 1 x 1/4"x119 |
| ⊕ | 8790 HMA | 1 x 5,5x23,0; 1 x 6,0x23,0; 1 x 7,0x23,0; 1 x 8,0x23,0; 1 x 10,0x23,0; 1 x 12,0x23,0; 1 x 13,0x23,0 |
| ⊕ | 851/4 Z PH | 1 x PH 1x89; 1 x PH 2x89; 1 x PH 3x89 |
| ⊕ | 840/4 Z Hex-Plus | 1 x 3,0x89; 1 x 4,0x89; 1 x 5,0x89; 1 x 6,0x89 |
| ⊕ | 867/4 Z TORX® | 1 x TX 10x89; 1 x TX 15x89; 1 x TX 20x89; 1 x TX 25x89; 1 x TX 30x89 |
| ⊕ | 800/4 Z | 1 x 1,0x5,5x89 |
| ⊕ | 847 HSS | 1 x 2,5x36,0; 1 x 3,3x39,0; 1 x 4,2x41,0; 1 x 5,0x44,0; 1 x 6,8x51,0; 1 x 8,5x59,0 |
| ⊕ | 848 HSS | 1 x 3,0x38,0; 1 x 4,0x44,0; 1 x 5,0x50,0; 1 x 6,0x50,0; 1 x 8,0x51,0; 1 x 10,0x54,0 |
| | 1441 | 1 x 4,5 - 6,0x41,0 |
| ⊕ | 247 | 1 x 0,5x3,0x70 |

Product not available in the USA and Canada.

Tip

Kraftform Kompakt H1 Woodcraft



Compact tool set with the 41 most important screwdriving tools for jobs involving wood.

Kraftform Kompakt W1 Maintenance



The perfect set for diverse maintenance jobs both indoors as well as outdoors - applications: electronics, mechatronics, building technology, photovoltaic etc. etc.

Kraftform Kompakt M1 Metal



Compact tool set with the 39 most important screwdriving tools for jobs involving metal.



Kraftform Kompakt user-specific sets

Kraftform Kompakt SH 1 PlumbKit



2 Joker combination ratchet wrenches with special retaining plate to prevent slipping/loss of the screw and more power transfer, 1 Zyklop ratchet 8000 A (1/4") for rapid, powerful operation, 3 Zyklop sockets 8790 HMA for manual and power tool applications, 1 Zyklop adapter 8784 A1 for bits, 6 TORX® HF bits 867/4 with holding function for TORX® screws for secure hold without any loss of the screw, 1 voltage tester 247, 2 Kraftform Series 100 VDE slotted screwdrivers 160 i and 160 iS for safe work up to 1,000 volts (160 iS has a reduced blade diameter with integrated protective insulation to allow sunken screw and spring elements to be reached and actuated) with "Take it easy" tool finder: colour coding according to profile and size stamp, 1 Kraftform chisel driver 932 A (slotted) with hexagon blade throughout and integrated impact cap for screwdriving and simple chiselling jobs, 2 socket wrench screwdrivers 395 HO with hollow shaft for the tightening or loosening of screws on long bolts as well as for jammed screws.

| | |
|-------------|---|
| 05135927001 | |
| ○ | Joker 1 x 10x159; 1 x 13x177 |
| ○ | 8000 A 1 x 1/4"x152,0 |
| ● | 8790 HMA 1 x 7,0x23,0; 1 x 10,0x23,0; 1 x 13,0x23,0 |
| ● | 8784 A1 1 x 1/4"x1/4"x37,0 |
| ⊕ | 867/4 TORX® HF 1 x TX 10x50; 1 x TX 15x50; 1 x TX 20x50; 1 x TX 25x50; 1 x TX 30x50; 1 x TX 40x50 |
| ⊕ | 851/4 Z PH 1 x PH 1x89; 1 x PH 2x89 |
| ○ | 840/4 Z Hex-Plus 1 x 3,0x89; 1 x 4,0x89; 1 x 5,0x89; 1 x 6,0x89 |
| ● | 247 1 x 0,5x3,0x70 |
| ● | 160 iS 1 x 0,6x3,5x100 |
| ● | 160 i VDE 1 x 1,0x5,5x125 |
| ● | 932 A 1 x 1,2x7,0x125 |
| ● | 395 HO 1 x 10,0x90; 1 x 13,0x90 |

* Product not available in the USA and Canada.



Bitholding Screwdrivers and Adaptors

Suitable for hand and power tool applications

3816 R Bit-holding screwdriver with Rapidaptor quick-release chuck, stainless



Application: Suitable for 1/4" hexagon insert bits, DIN ISO 1173-C 6,3 and E 6,3 and Wera Series 1 and 4

Drive: 1/4" hexagon with Rapidaptor rapid-in, rapid-out, rapid-spin, chuck-all and single-hand technology

Handle: Kraftform with non-roll feature, multi-component

| | | |
|-------------|------|-----|
| | | |
| | | mm |
| 05051465001 | 1/4" | 119 |

816 R Bitholding screwdriver with Rapidaptor quick-release chuck



Application: Suitable for 1/4" DIN ISO 1173-C 6,3 and E 6,3 hexagon insert bits and Wera Series 1 and 4

Drive: 1/4" hexagon with Rapidaptor rapid-in, rapid-out, rapid-spin, chuck-all and single-hand technology, magnetic

Handle: Kraftform with non-roll feature, multi-component

| | | |
|-------------|------|-----|
| | | |
| | | mm |
| 05051462001 | 1/4" | 119 |

813 R Bitholding screwdriver with Rapidaptor quick-release chuck



Application: Suitable for 1/4" DIN ISO 1173-C 6,3 and E 6,3 hexagon insert bits and Wera Series 1 and 4

Drive: 1/4" hexagon with Rapidaptor rapid-in, rapid-out, rapid-spin, chuck-all and single-hand technology, magnetic

Handle: Kraftform with non-roll feature, multi-component

| | | |
|-------------|------|----|
| | | |
| | | mm |
| 05051272001 | 1/4" | 90 |

816 R SB Bitholding screwdriver with Rapidaptor quick-release chuck

| | |
|-------------|--------------|
| | |
| 05073540001 | 4013288 |
| | 106032 |
| | 1 x 1/4"x119 |



489 R T-handle Rapidaptor



Application: Suitable for 1/4" DIN ISO 1173-C 6,3 and E 6,3 hexagon insert bits and Wera Series 1 and 4

Drive: 1/4" hexagon with Rapidaptor rapid-in, rapid-out, rapid-spin, chuck-all and single-hand technology, magnetic

Handle: T-handle, multi-component

| | | | | | | |
|-------------|------|----|----|----|----------|--|
| | | | | | | |
| | | mm | mm | mm | | |
| 05013390001 | 1/4" | 45 | 44 | 87 | 1 25/32" | |



Rapidaptor

817 R Bitholding screwdriver with Rapidaptor quick-release chuck



Application: Suitable for 1/4" DIN ISO 1173-C 6.3 and E 6,3 hexagon insert bits and Wera Series 1 and 4

Drive: 2 position telescopic blade, can be retracted into the handle for confined space operation or extended for more reach, can also be removed and used as a 100mm bit holder in the power tool, 1/4" hexagon suitable for power tools with DIN ISO 1173-F 6.3 chuck

Design: 1/4" hexagon with Rapidaptor rapid-in, rapid-out, rapid-spin, chuck-all and single-hand technology, magnetic

Handle: Kraftform with non-roll feature, multi-component

| | | |
|-------------|------|-----|
| | | |
| | | mm |
| 05051482001 | 1/4" | 133 |

817 R SB Bitholding screwdriver with Rapidaptor quick-release chuck

| | | |
|-------------|--------------|---------|
| | | |
| | | 4013288 |
| 05073541001 | 1 x 1/4"x133 | 106025 |



Rapid-in and self-lock



The bit can be pushed into the adaptor without moving the sleeve. The lock is activated automatically as soon as the bit is applied to the screw. Bits are held securely and wobble-free.

Rapid-out



Simply push the sleeve forward to change the bit. The spring mechanism lifts the bit off the magnet and unlocks the tool. The bit can be easily removed. The rapid-out function makes it easy to remove even the smallest bits without extra tools.

Chuck-all



The Rapidaptor quick-release chucks hold 1/4" DIN ISO 1173-C 6,3 and E 6,3 as well as Wera series 1 and 4 bits.

Single-hand function



Every function of the Rapidaptor quick-release chuck, such as inserting or releasing bits, can be carried out with one hand. This is faster, more economical and more ergonomic. There are no unnecessary manoeuvres.



Bitholding Screwdrivers and Adaptors

Suitable for hand and power tool applications

820/1/6 Combination screwdriver with strong permanent magnet and bits



Application: Suitable for 1/4" DIN ISO 1173-C 6,3 hexagon insert bits and Wera Series 1

Blade: Hexagon

Design: Strong permanent magnet

Handle: Kraftform, single-component, rotary magazine

| | |
|-------------|--|
| | |
| 05051620001 | |
| | 819/1 Vario 1 x 1/4"x120 |
| | 867/1 Z TORX® 1 x TX 10x25; 1 x TX 15x25; 1 x TX 20x25; 1 x TX 25x25; 1 x TX 30x25; 1 x TX 40x25 |

819/1/6 PH Combined Screwdriver with strong permanent magnet and bits



Application: Suitable for 1/4" DIN ISO 1173-C 6,3 hexagon insert bits and Wera Series 1

Blade: Hexagon

Design: With strong permanent magnet

Handle: Kraftform, one component, rotary magazine

| | |
|-------------|--|
| | |
| 05346280001 | |
| | 819/1 Vario 1 x 1/4"x120 |
| | 851/1 Z PH 1 x PH 1x25; 1 x PH 2x25; 1 x PH 3x25 |
| | 800/1 Z 1 x 0,6x4,5x25; 1 x 1,0x5,5x25; 1 x 1,2x6,5x25 |

819/1/6 Combination screwdriver with strong permanent magnet and bits



Application: Suitable for 1/4" DIN ISO 1173-C 6,3 hexagon insert bits and Wera Series 1

Blade: Hexagon

Design: Strong permanent magnet

Handle: Kraftform, single-component, rotary magazine

| | |
|-------------|--|
| | |
| 05051615001 | |
| | 819/1 Vario 1 x 1/4"x120 |
| | 851/1 Z PH 1 x PH 1x25; 1 x PH 2x25 |
| | 855/1 Z PZ 1 x PZ 1x25; 1 x PZ 2x25 |
| | 800/1 Z 1 x 0,8x5,5x25; 1 x 1,2x6,5x25 |

819/1 Combination screwdriver with strong permanent magnet, without bits



Application: Suitable for 1/4" DIN ISO 1173-C 6,3 hexagon insert bits and Wera Series 1

Blade: Hexagon

Design: Strong permanent magnet

Handle: Kraftform, single-component, rotary magazine

| | | | | | |
|-------------|------|-----|-----|------|--------|
| | | | | | |
| | | mm | mm | mm | mm |
| 05051610001 | 1/4" | 120 | 110 | 10,5 | 4 3/4" |





392 Bitholding screwdriver with flexible shaft



Application: Suitable for 1/4" DIN ISO 1173-C 6,3 hexagon bits and Wera Series 1

Design: Wera quick-release chuck

Handle: Kraftform with non-roll feature, multi-component

| |  |  mm |  mm |  " |
|-------------|---|---|---|--|
| 05028160001 | 1/4" | 177 | 98 | 7" |



813 Bitholding screwdriver



Application: Suitable for 1/4" DIN ISO 1173-C 6,3 hexagon insert bits and Wera Series 1

Drive: 1/4" hexagon, magnetic

Handle: Kraftform with non-roll feature, multi-component

| |  |  mm |  mm |
|-------------|---|---|---|
| 05051274001 | 1/4" | 78 | 68 |

812/1 Bitholding screwdriver with strong permanent magnet







Application: Suitable for 1/4" DIN ISO 1173-C 6,3 hexagon insert bits and Wera Series 1

Blade: Hexagon

Design: Strong permanent magnet, chrome-plated

Handle: Kraftform with non-roll feature, multi-component

| |  |  mm |  mm |  mm |  " |
|-------------|---|---|---|---|--|
| 05051205001 | 1/4" | 120 | 112 | 10,5 | 4 3/4" |

811/1 Stubby







Application: Suitable for 1/4" DIN ISO 1173-C 6,3 hexagon insert bits and Wera Series 1

Blade: Round

Design: Extra short with strong permanent magnet

Handle: Kraftform, single-component

| |  |  mm |  mm |  " |
|-------------|---|---|---|--|
| 05051105001 | 1/4" | 10 | 54 | 3/8" |

810/1 Bitholding screwdriver with retaining ring







Application: Suitable for 1/4" DIN ISO 1173-C 6,3 hexagon insert bits and Wera Series 1

Blade: Hexagon

Design: Retaining ring, chrome-plated

Handle: Kraftform with non-roll feature, multi-component

| |  |  mm |  mm |  mm |  " |
|-------------|---|---|---|---|--|
| 05051005001 | 1/4" | 120 | 112 | 10,5 | 4 3/4" |

Kraftform Kompakt Vario

With Ratchet Function

Kraftform Kompakt 60 RA



Pouch with 89 mm bits
17-piece set

1 hand-held bit holder 816 RA Kraftform with ratchet function, fine-tooth design for minimal return angle, switchover ring (right, locked, left), maximum torque of up to 50 Newton metres, 1/4" hexagon chuck with Rapidaptor technology i.e. rapid-in, rapid-out, rapid-spin, chuck-all and single-hand function for rapid bit change, magnetic and 16 bits of 89 mm in length suitable for holders as per DIN ISO 1173-F 6,3 or for direct insertion in a power tool

| | |
|-------------|---|
| 05051040001 | |
| ● | 816 RA 1 x 1/4"x142,0 |
| + | 851/4 Z PH 1 x PH 1x89; 1 x PH 2x89; 1 x PH 3x89 |
| + | 855/4 Z PZ 1 x PZ 1x89; 1 x PZ 2x89; 1 x PZ 3x89 |
| + | 867/4 Z TORX® BO 1 x TX 10x89; 1 x TX 15x89; 1 x TX 20x89; 1 x TX 25x89; 1 x TX 30x89 |
| ● | 800/4 Z 1 x 1,0x5,5x89 |
| ○ | 840/4 Z Hex-Plus 1 x 3,0x89; 1 x 4,0x89; 1 x 5,0x89; 1 x 6,0x89 |

Kraftform Kompakt 60 RA, imperial

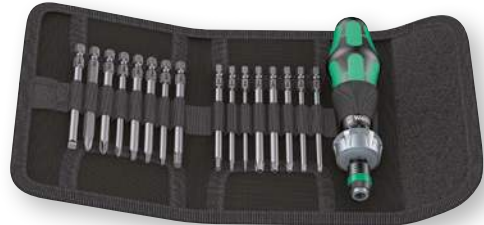

Pouch with 89 mm bits
17-piece set

1 hand-held bit holder 816 RA Kraftform with ratchet function, fine-tooth design for minimal return angle, switchover ring (right, locked, left), maximum torque of up to 50 Newton metres, 1/4" hexagon chuck with Rapidaptor technology i.e. rapid-in, rapid-out, rapid-spin, chuck-all and single-hand function for rapid bit change, magnetic and 16 bits of 89 mm in length suitable for holders as per DIN ISO 1173-F 6,3 or for direct insertion in a power tool

| | |
|-------------|---|
| 05051041001 | |
| ● | 816 RA 1 x 1/4"x142,0 |
| + | 851/4 Z PH 1 x PH 1x89; 1 x PH 2x89; 1 x PH 3x89 |
| + | 867/4 Z TORX® BO 1 x TX 10x89; 1 x TX 15x89; 1 x TX 20x89; 1 x TX 25x89; 1 x TX 30x89 |
| ● | 800/4 Z 1 x 1,0x5,5x89 |
| ○ | 840/4 Z Hex-Plus 1 x 3/32"x89; 1 x 1/8"x89; 1 x 5/32"x89; 1 x 3/16"x89 |
| ○ | 868/4 Square-Plus 1 x # 1x89; 1 x # 2x89; 1 x # 3x89 |

816 RA Ratchet screwdriver



Application: Suitable for hexagon socket insert bits as per DIN ISO 1173-C 6,3 and E 6,3 and Wera series 1 and 4

Design: Ratchet, fine-tooth design for minimal return angle, switchover ring (right, locked, left), maximum torque of up to 50 Newton metres, 1/4" hexagon chuck with Rapidaptor technology i.e. rapid-in, rapid-out, rapid-spin, chuck-all and single-hand function for rapid bit change, magnetic

Handle: Kraftform with non-roll feature, multi-component

| | | | |
|-------------|------|-------|----|
| | ○ | 816 | mm |
| 05051461001 | 1/4" | 142,0 | |



80 RA Vario ratchet screwdriver



Application: Suitable for 6 mm Wera Vario blades

Design: Ratchet, fine-tooth design for minimal return angle, switchover ring (right, locked, left), maximum torque of up to 50 Newton metres, 6 mm hexagon chuck

Handle: Kraffform with non-roll feature, multi-component







| |  |  |
|-------------|---|---|
| | mm | mm |
| 05002901001 | 6 | 115,0 |

Kraffform Kompakt Vario RA SB



Pouch with 175 mm Wera Vario double-ended blades, 6 mm hexagon shaft
7-piece set

1 Kraffform Kompakt Vario RA hand-held bit holder with ratchet function, fine-tooth design for minimal return angle, switchover ring (right, fixed, left), maximum torque of up to 50 Newton meters, 6 mm hexagon chuck for Wera Vario double-ended blades, 6 Vario double-ended blades (= 12 different dimensions)

|  | | |
|---|------------------|--|
| 05073665001 | | |
|  | 80 RA | 1 x 6x115,0 |
|  | 85 | 1 x PH 1xPH 2x175 |
|  | 86 | 1 x PZ 1xPZ 2x175 |
|  | 87 | 1 x TX 10xTX 15x175; 1 x TX 20xTX 25x175 |
|  | 81 | 1 x 0,6x4,0x1,0x6,0x175 |
|  | 84 ¹⁾ | 1 x 4x5x175 |

¹⁾ without ball-end

Tip

Fine-tooth design



Fine action 44 tooth system for precision work. Great time savings when screwdriving.

Reverse direction switch



Ergonomic design of the reverse direction switch.

Fine adjustment work

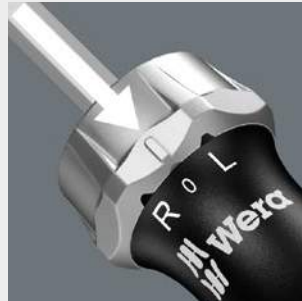

Additionally, the lockable neutral position permits exact adjustment work without having to change the screwdriving direction every time. Lockable neutral position for fine adjustment work.

Kraffform Kompakt Vario RA SB



The 6 mm double-ended blades of 175 mm length are out of high quality bit material which gives them a particularly long service life.

Kraftform Kompakt Vario

With Ratchet Function

Kraftform Kompakt Pistol RA



7-piece set

1 hand-held bit holder 814 RA Kraftform, integrated Magazine, with ratchet function, fine-tooth design for minimal return angle, switchover ring (right, locked, left), maximum torque of up to 50 Newton metres, $\frac{1}{4}$ " hexagon chuck with Rapidaptor technology i.e. rapid-in, rapid-out, rapid-spin, chuck-all and single-hand function for rapid bit change, magnetic and 6 bits of 25 mm in length suitable for holders as per DIN ISO 1173-D 6,3

Holster

| | |
|-------------|--|
| 05051030001 | |
| + | 814 RA 1 x 1/4" |
| + | 851/1 Z PH 1 x PH 1x25; 1 x PH 2x25 |
| + | 855/1 Z PZ 1 x PZ 1x25; 1 x PZ 2x25 |
| + | 867/1 TORX® 1 x TX 20x25; 1 x TX 25x25 |

Kraftform Kompakt Pistol RA 4



13-piece set

1 hand-held bit holder 814 RA Kraftform, integrated Magazine, with ratchet function, fine-tooth design for minimal return angle, switchover ring (right, locked, left), maximum torque of up to 50 Newton metres, $\frac{1}{4}$ " hexagon chuck with Rapidaptor technology i.e. rapid-in, rapid-out, rapid-spin, chuck-all and single-hand function for rapid bit change, magnetic, 6 bits of 25 mm in length suitable for holders as per DIN ISO 1173-D 6.3 and 6 bits of 89 mm in length suitable for holders as per DIN ISO 1173-F 6.3

Holster

| | |
|-------------|--|
| 05051031001 | |
| | 814 RA 1 x 1/4" |
| + | 851/1 BTZ PH 1 x PH 1x25; 1 x PH 2x25 |
| + | 855/1 BTZ PZ 1 x PZ 1x25; 1 x PZ 2x25 |
| + | 867/1 TORX® 1 x TX 20x25; 1 x TX 25x25 |
| | BTZ |
| + | 851/4 Z PH 1 x PH 1x89; 1 x PH 2x89 |
| + | 855/4 Z PZ 1 x PZ 1x89; 1 x PZ 2x89 |
| + | 867/4 Z TORX® 1 x TX 20x89; 1 x TX 25x89 |

Kraftform Kompakt 27 RA 1 SB



Application: Suitable for hexagon socket insert bits as per DIN ISO 1173-C 6,3 and Wera series 1

Design: Ratchet, fine-tooth design for minimal return angle, switchover ring (right, locked, left), maximum torque of up to 50 Newton metres, hexagon blade with $\frac{1}{4}$ " hexagon chuck, stainless steel sleeve, strong permanent magnet

Handle: Kraftform with non-roll feature, multi-component, integrated magazine

| | |
|-------------|--|
| 05073660001 | |
| + | 851/1 Z PH 1 x PH 1x25; 1 x PH 2x25 |
| + | 855/1 Z PZ 1 x PZ 1x25; 1 x PZ 2x25 |
| + | 800/1 Z 1 x 1,0x5,5x25; 1 x 1,2x6,5x25 |

Kraftform Kompakt 27 RA 2 SB



Application: Suitable for hexagon socket insert bits as per DIN ISO 1173-C 6,3 and Wera series 1

Design: Ratchet, fine tooth system for minimal return angle, switchover ring (clockwise, locked, anticlockwise), maximum torque of up to 50 Newton metres, hexagon blade with $\frac{1}{4}$ " hexagon chuck, stainless steel sleeve, strong permanent magnet

Handle: Kraftform with non-roll feature, multi-component, integrated magazine for 6 bits (25 mm)

| | |
|-------------|--|
| 05073661002 | |
| + | 851/1 Z PH 1 x PH 1x25; 1 x PH 2x25 |
| + | 800/1 Z 1 x 1,0x5,5x25; 1 x 1,2x6,5x25 |
| + | 868/1 Z 1 x # 1x25; 1 x # 2x25 |



Kraftform Kompakt Vario

Without Ratchet Function

88/1 Vario set



11-piece set, specifically for demanding workshop environments

| Icon | Part No. | Description |
|------|----------|---|
| ● | 80 | 1 x 6x98 |
| ⊕ | 85 | 1 x PH 1xPH 2x175 |
| ⊕ | 86 | 1 x PZ 1xPZ 2x175 |
| ⊗ | 87 | 1 x TX 10xTX 15x175; 1 x TX 20xTX 25x175; 1 x TX 30xTX 40x175 |
| ⊖ | 81 | 1 x 0,6x4,0x1,0x6,0x175; 1 x 0,8x5,0x1,2x7,0x175 |
| ○ | 84 | 1 x 4x4x175; 1 x 5x5x175; 1 x 6x6x175 |

80 Vario handle



Application: 6 mm Vario blades and adaptors

Handle: Kraftform with non-roll feature, multi-component, 10 mm bolster

| Icon | mm | mm | mm |
|------|----|----|----|
| ● | 6 | 10 | 98 |

95 Vario T-handle



Application: 6 mm Vario blades and adaptors

Handle: T-handle, single-component

| Icon | mm | mm | mm | mm |
|------|----|----|----|--------|
| ● | 6 | 56 | 44 | 2 1/4" |

830 Vario bit holder adaptor



Application: Suitable for 1/4" DIN ISO 1173-C 6,3 hexagon insert bits and Wera Series 1

Blade: 6 mm hexagon, chrome-plated

Drive: Wera 1/4" quick-release chuck with strong permanent magnet

| Icon | mm | mm | mm | mm |
|------|------|----|-----|---------|
| ● | 1/4" | 6 | 165 | 6 9/16" |

91 Vario extension



Application: Vario blades and adaptors

Blade: 6 mm hexagon, chrome-plated





Drive: 6 mm hexagon socket

| Icon | mm | mm | mm | mm |
|------|----|----|-----|----|
| ● | 6 | 6 | 175 | 7" |

712 Vario socket adaptor









Application: Suitable for 1/4" square drive sockets
Blade: 6 mm hexagon, chrome-plated
Drive: 1/4" square head

| |  |  mm |  mm |  mm |
|-------------|---|---|---|---|
| 05040001001 | 1/4" | 6 | 175 | 7" |

81 Combination blade for slotted screws









Application: Slotted screws
Blade: 6 mm hexagon
Design: Chrome-plated, Black Point

| |  mm |  mm |  mm |  mm |  mm |  mm |  mm |
|-------------|---|---|---|---|---|---|---|
| 05002910001 | 0,6 | 4,0 | 1,0 | 6,0 | 6 | 175 | 7" |
| 05002913001 | 0,8 | 5,0 | 1,2 | 7,0 | 6 | 175 | 7" |

82 Combination blade for slotted/Phillips screws



Application: Slotted screws and Phillips screws
Blade: 6 mm hexagon
Design: Chrome-plated, Black Point

| |  |  mm |  mm |  mm |  mm |  mm |
|-------------|---|---|---|---|---|---|
| 05002920001 | PH 1 | 0,6 | 4,0 | 6 | 175 | 7" |
| 05002923001 | PH 2 | 1,0 | 6,0 | 6 | 175 | 7" |
| 05002926001 | PH 3 | 1,2 | 7,0 | 6 | 175 | 7" |

Tip



Black Point Tip

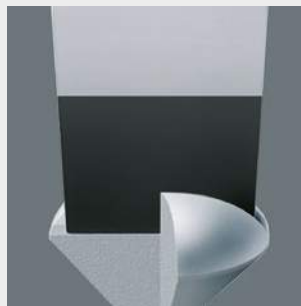

The Wera Black Point tip provides an exact fit with optimum corrosion protection.

High quality bit material



The 6 mm double-ended blades of 175 mm length are out of high quality bit material which gives them a particularly long service life.

Adaptor



1/4" hexagon and square drives as per DIN ISO 1173-C 6,3 and DIN 3120 can also be driven with the 6 mm handles by attaching an adaptor.



Kraftform Kompakt Vario

Without Ratchet Function

83 Combination blade for Phillips/Pozidriv screws



Application: Phillips screws and Pozidriv screws

Blade: 6 mm hexagon

Design: Chrome-plated, Black Point

| | | | mm | mm | |
|-------------|------|------|----|-----|----|
| 05002930001 | PH 1 | PZ 1 | 6 | 175 | 7" |
| 05002933001 | PH 2 | PZ 2 | 6 | 175 | 7" |

86 Combination blade for Pozidriv screws



Application: Suitable for Pozidriv screws

Blade: 6 mm hexagon

Design: Chrome-plated, Black Point

| | | | mm | mm | |
|-------------|------|------|----|-----|----|
| 05002960001 | PZ 1 | PZ 2 | 6 | 175 | 7" |
| 05140310001 | PZ 2 | PZ 3 | 6 | 175 | 7" |

84 Combination blade for hexagon socket screws



Application: Hexagon socket screws

Blade: 6 mm hexagon

Design: Chrome-plated, Black Point

| | | | mm | mm | |
|---------------------------|-----|-----|----|-----|----|
| 05002936001 | 2,5 | 2,5 | 6 | 175 | 7" |
| 05002938001 | 3 | 3 | 6 | 175 | 7" |
| 05002940001 | 4 | 4 | 6 | 175 | 7" |
| 05002943001 | 5 | 5 | 6 | 175 | 7" |
| 05002948001 ¹⁾ | 4 | 5 | 6 | 175 | 7" |
| 05002946001 | 6 | 6 | 6 | 175 | 7" |

¹⁾ without ball-end

87 Combination blade for TORX® screws



Application: TORX® socket screws

Blade: 6 mm hexagon

Design: Chrome-plated, Black Point

| | | | mm | mm | |
|-------------|-------|-------|----|-----|----|
| 05002966001 | TX 6 | TX 8 | 6 | 175 | 7" |
| 05002968001 | TX 7 | TX 9 | 6 | 175 | 7" |
| 05002970001 | TX 10 | TX 15 | 6 | 175 | 7" |
| 05002973001 | TX 20 | TX 25 | 6 | 175 | 7" |
| 05002976001 | TX 30 | TX 40 | 6 | 175 | 7" |

85 Combination blade for Phillips screws



Application: Phillips screws

Blade: 6 mm hexagon

Design: Chrome-plated, Black Point

| | | | mm | mm | |
|-------------|------|------|----|-----|----|
| 05002950001 | PH 1 | PH 2 | 6 | 175 | 7" |

68 Combination blade for square socket screws



Application: For square socket screws

Blade: 6 mm hexagon

Design: Mat nickel, Black Point

| | | | mm | mm | |
|-------------|----|----|----|-----|----|
| 05002980001 | #1 | #2 | 6 | 175 | 7" |



044 377-0

Unt. Bwg 20.9.72





Wera 2go

| | | |
|---|-------------------------------|------------|
|  | Wera 2go 1 Tool Carrier | 300 |
|  | Wera 2go 2 Tool Container | 300 |
|  | Wera 2go 3 Tool Box | 300 |
|  | Wera 2go 4 Tool Quiver | 300 |
|  | Wera 2go 5 Tool Carrier | 301 |
|  | Wera 2go 6 Shoulder Strap | 301 |
|  | Hook and Loop Fastener Strips | 303 |



Wera 2go

We wanted to provide our textile boxes and pouches with a mobile home.

After all, increasingly more users are more often out and about with their tools and they frequently complain about too much weight.

So we started searching for an idea which would keep the hands free during walking and with which one could dock and undock the required tools very easily.



Wera 2go 1 – The outside packer
Wera 2go Tool Carrier with hook and loop fastener system. For the docking of the Wera textile boxes and pouches with hook and loop fastener zones. Individually configurable for greater mobility. Hands remain free during transport. Includes an adjustable, detachable Shoulder Strap with a wide padded section.

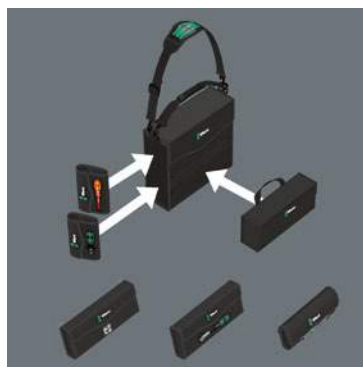

Wera 2go 2 – The outside and inside packer
Wera 2go Tool Container with inner and outer hook and loop fastener system. Individually configurable for greater mobility. Ideal also for the docking of Wera textile boxes and pouches equipped with hook and loop fastener zones. Easy insertion and removal. Hands remain free during transport.



Wera 2go 3 – The inside packer
Permanently dimensionally stable thanks to the fabric-lined plastic panels. High resistance against cuts and stabs. High protection of the tools transported against damage and moisture. Can be individually equipped.

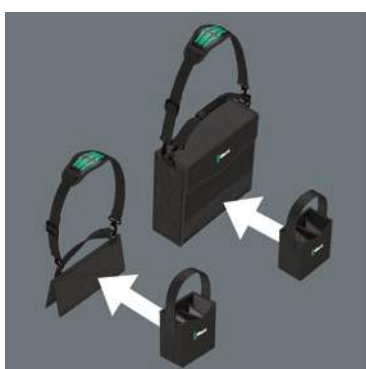

Wera 2go 4 – Tool Quiver

Dimensionally stable Wera 2go Tool Quiver. High resistance against cuts and stabs. Variable hook and loop fastener partition for a division into as many as 5 inner sections. Large set-down area; handle for carrying and hanging up.

Wera 2go

Tool transport - mobile, flexible, individual

Wera 2go 1 Tool Carrier







1 tool carrier with hook and loop fastener system for the attachment of other Wera 2go components as well as Wera textile boxes and pouches with hook and loop fastener zones; 1 shoulder strap with adjustable-width padding, adjustable in length, detachable.

| | |
|---|----------------------------|
|  | |
| 05004350001 | |
| | Wera 2go 5 1 x 135x300x270 |
| | Wera 2go 6 1 x 38x1470 |

Wera 2go 3 Tool Box



1 dimensionally stable and robust Tool Box, empty, equipped with handle for the storage and transport of tools and small parts; high resistance against cuts and stabs; comes with hook and loop fastener zone for docking with the Wera 2go system.

| | | | |
|---|---|---|---|
|  | | | |
| |  |  |  |
| | mm | mm | mm |
| 05004352001 | 130 | 325 | 80 |

Wera 2go 2 Tool Container





1 dimensionally stable, robust Tool Container with hook and loop fastener system for the attachment of other Wera 2go components as well as Wera textile boxes and pouches with hook and loop fastener zones; high resistance against cuts and stabs; 1 handle and 1 Shoulder Strap with adjustable-width padding, adjustable in length, detachable; 1 removable Tool Quiver with handle and a variable hook and loop fastener partition for a division into as many as 5 inner sections.

| | |
|-------------|------------------------------------|
| 05004351001 | |
| | Wera 2go Container 1 x 330x355x115 |
| | Wera 2go 6 1 x 38x1470 |
| | Wera 2go 4 1 x 165x165x105 |

Wera 2go 4 Tool Quiver



1 dimensionally stable and robust Tool Quiver, empty, equipped with handle for the storage and transport of tools; high resistance against cuts and stabs; comes with hook and loop fastener zone for docking with the Wera 2go system and includes 1 variably adjustable hook and loop fastener partition for a division into as many as 5 sections.

| | | | |
|-------------|---|---|---|
| |  |  |  |
| | mm | mm | mm |
| 05004353001 | 165 | 165 | 105 |

Wera 2go 5 Tool Carrier



1 Tool Carrier with hook and loop fastener system for the attachment of other Wera 2go components as well as Wera textile boxes and pouches with hook and loop fastener zones.

| | | | |
|-------------|-----|-----|-----|
| | | | |
| | mm | mm | mm |
| 05004354001 | 135 | 300 | 270 |

Wera 2go 6 Shoulder Strap



1 Shoulder Strap, adjustable in length with variable-width padding for great carrying comfort and convenience.

| | | |
|-------------|----|------|
| | | |
| | mm | mm |
| 05004355001 | 38 | 1470 |

Tip

Robust and dimensionally stable



The robust and dimensionally stable material protects the tools carried against damage and moisture and enhances the service life of the tool container.

Variable thanks to the hook and loop fastener system

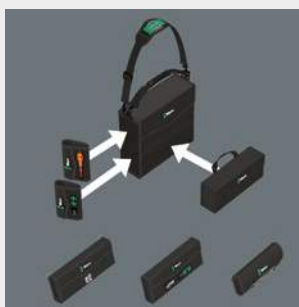

The inner and outer hook and loop fastener sections mean that other Wera 2go system components can be just as easily attached as all other Wera tools in boxes and pouches with hook and loop fastener zones. This enables an individual composition of the tools needed for a specific job.

High resistance against cuts and stabs



The robust and dimensionally stable material is very resistant against cuts and stabs. The tools carried are protected against damage and moisture. This enhances the service life of the tool box.

Perfect system supplement



Thanks to its hook and loop fastener zone, the Tool Box can be docked with the Wera 2go 1 Tool Carrier and with the Wera 2go 2 Tool Container.





” To learn more about this product, scan the QR code. “

Hook and Loop Fastener Strip 1



Self-adhesive hook and loop fastener strips. They can be attached to walls or workshop trolleys; suitable for the attachment of Wera 2go components or Wera pouches or textile boxes with nonwoven sections.

| | |
|-------------|---|
| 05670446001 | |
| | Hook and Loop Fastener Strip 70 1 x 50x70 |

Hook and Loop Fastener Strip 2



Self-adhesive hook and loop fastener strips. They can be attached to walls or workshop trolleys; suitable for the attachment of Wera 2go components or Wera pouches or textile boxes with nonwoven sections.

| | |
|-------------|---|
| 05670447001 | |
| | Hook and Loop Fastener Strip 120 1 x 50x120 |

Hook and Loop Fastener Strip 3



Self-adhesive hook and loop fastener strips. They can be attached to walls or workshop trolleys; suitable for the attachment of Wera 2go components or Wera pouches or textile boxes with nonwoven sections.

| | |
|-------------|---|
| 05670448001 | |
| | Hook and Loop Fastener Strip 240 1 x 50x240 |

Tip

Would you like to attach your pouch with a nonwoven section to the wall or workshop trolley?

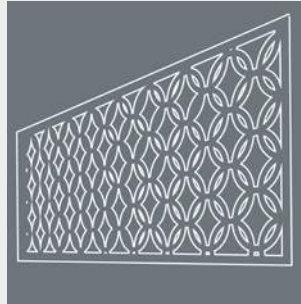

No problem! In such cases we also have self-adhesive hook and loop fastener strips available.



Which textile boxes can be docked with the Wera 2go system without the need for any additional aids?



Wera packaging bearing this symbol contains tool pouches or textile boxes with nonwoven sections that can be docked with the Wera 2go system.





Products for Power Tool Use



Bits

308



Holders and Adaptors

404



Sets





















430





Werd
BE 4 TOOL REB

Bits

| | | | |
|---|------------|---|------------|
|  Bits for Phillips Screws | 316 |  Bits for Multi-Point Screws | 396 |
|  Bits for Pozidriv Screws | 338 |  Bits for Hi-TORQUE Screws | 397 |
|  Bits for PlusMinus Screws – Slotted/Phillips | 350 |  Bits for Microstix® Screws | 398 |
|  Bits for PlusMinus Screws – Slotted/Pozidriv | 351 |  Bits for Spanner Screws | 400 |
|  Bits for TORX® Screws | 352 |  Nutsetters | 401 |
|  Bits for TORX® BO Screws | 366 |  Internal Thread Insertion Tool | 403 |
|  Bits for TORX PLUS® Screws | 368 | | |
|  Bits for TORX PLUS® IPR Screws | 372 | | |
|  Bits for ASSY® Screws | 375 | | |
|  Bits for Slotted Screws, Guide Sleeves | 376 | | |
|  Bits for Hexagon Socket Screws | 380 | | |
|  Bits for Hexagon Socket BO Screws | 387 | | |
|  Bits for Square Socket Screws | 388 | | |
|  Bits for TORQ-SET® Screws | 392 | | |
|  Bits for TRI-WING®-Screws | 395 | | |



Bits

The right bit for every screw and for every power tool connection. The right quality for every user.

Thanks to the high-precision profile design and the outstanding concentricity properties, Wera bits provide for dependable working and offer great durability. Wera bits are designed for professional applications in industry as well as in the trade.

They enable higher torque transfer and typically have a long service life. Material and manufacturing expertise, established over decades, combined with sophisticated hardening technologies form the foundation upon which our premium quality is based.



Impaktor Bits

Impact bits are needed when a strong power tool is used. Impact bits were specifically developed to withstand high power tool forces.

Stainless Steel Bits

Wera stainless steel bits are manufactured out of stainless steel so unsightly rust can be avoided. The stainless steel bits from Wera are vacuum ice-hardened and have the hardness and strength needed for screw connections. There are no limitations to the industrial applications they are suitable for.

BiTorsion Bits

BiTorsion bits are absolutely premium products. They have a softer BiTorsion zone which reduces the hardness of the shaft in comparison to the drive tip. This means that the peak loads that cause bit breakage and premature wear are absorbed in this zone – something which enhances the service life of the bits.



Bits with diamond coating

The diamond coating of the DC bits lowers the danger of slipping as the minute diamond particles literally “bite” themselves into the screw head.

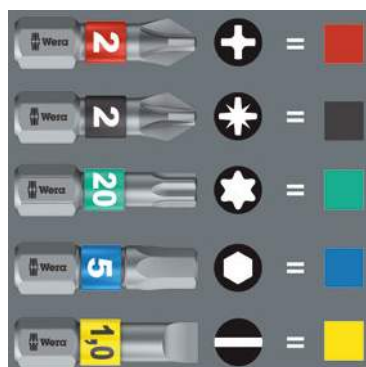

“Take it easy”

“Take it easy” tool finder with colour coding according to profiles and size stamp – for simple and rapid accessing of the required tool.



Impaktor Bits

We were not too happy that disintegrating bits flew around users faces as screwdriving with power tools took place with ever-higher power outputs.

We scrutinised the geometry and material properties of the bits for every screw profile. We analysed the destroyed bits, holders and screws in detail. The result is the Impaktor system – our entire know-how from bit manufacturing combined in our very best bit series.



For use with impact screwdrivers. Improve productivity when screwdriving with power tools.



Maximum utilisation of the material properties, a very special geometry – designed particularly to meet the extreme demands – as well a specific manufacturing process mean that Wera Impaktor tools have an above-average service life.



Particularly high strength. Reduce the danger of premature bit breakage.

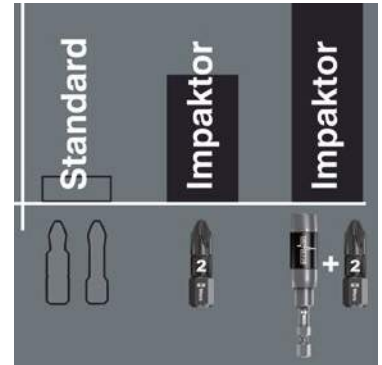

Torsion zone specially designed to absorb such forces and thereby protect the bit tip.



Another product advantage is the coating of the Impaktor bits with minute diamond particles.



These diamond particles reduce the cam-out effects – particularly high in power tool applications – which can lead to a slipping out of the screw head. The diamond particles literally bite themselves into the screw recess. This means that less contact pressure is required, something that greatly delays fatigue setting-in in power tool screwdriving jobs.



Wera's Impaktor system consisting of Impaktor bits and Impaktor holders is today's necessary addition to the BiTorsion system with the creation of the TriTorsion system.



The combination of the double torsion zones in the Impaktor holder and the torsion zone in the Impaktor bit result in the so-called TriTorsion system.



BiTorsion Bits

Peak forces that occur in power tool applications often result in premature wear of bits or damage to the screw head. This usually occurs during initial power-up and the when the screw comes to a standstill.

Screwdriving could become more productive and safer if these peak loads could be minimised. The Wera BiTorsion system prevents premature wear. The service life of the tool is extended and the productivity of power tool applications significantly increased.



The torsion spring integrated into the unique BiTorsion holder absorbs lower levels of peak loads (Phase 1). Any overloading of this spring is effectively prevented by means of a supporting mechanism.

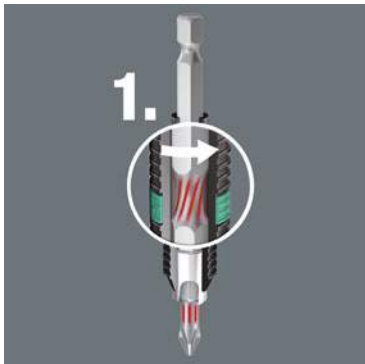

Higher peak loads are minimised through the torsion effect of the bit shaft (Phase 2). This effect is achieved with a specific heat treatment after the hardening process of the bits. This reduces the hardness of the shaft in comparison to the drive tip.

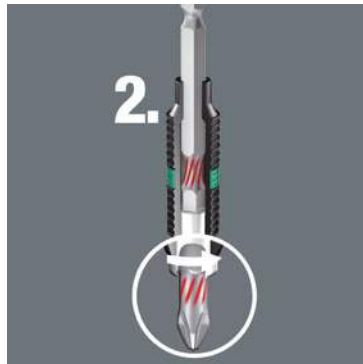

The BiTorsion holder and the BiTorsion bit can, of course, be used independently of one another.

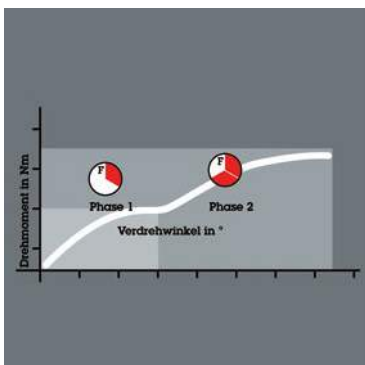

Even the service life of conventional bits is enhanced with the use of the BiTorsion holder and the BiTorsion bit also functions in a normal holder.



The effectiveness of the BiTorsion system comes from a combination of two shock-absorbing spring elements. Both bits as well as holders have a cushioning torsion zone that diverts the kinetic energy away from the drive tip during peak loads.



The optimally coordinated features of the torsion zones on the bit and holder permit a phased yield when under strain. The two-phase system prevents premature wear. Moreover, a long tool service life is also ensured by the hardness of the bits that matches the respective application.



NO STEP



Diamond-coated Bits

One of the greatest problems with power tool applications is that the conventional bit easily slips out of the head of the screw (cam-out). This often destroys both the head of the screw and the tool.

High resulting costs are incurred e.g. from damaged surfaces and screw connections that can no longer be loosened.

Screwdriving will become safer and more economic if this problem of slipping can be minimised.



To solve this fundamental problem, Wera launched a diamond-coated bit on to the market in 1992.



Today, the Wera diamond bit – manufactured with the technology specifically developed by Wera for this application – still sets the standard in terms of resilience and functionality. Wera bits with a diamond coating ensure a secure fit of the bit in the screw head.



Particularly when applications involve sensitive materials or high quality surfaces are involved, bits with a diamond coating ensure that work is done safer, faster and at lower cost.



The minute diamond particles applied to the tip of the tool literally “bite” into the screw and ensure an exact, anti-slip fit in the head of the screw. This secure fit protects the screw. The cam-out forces which compel the user to apply greater pressure to the screw are considerably reduced.



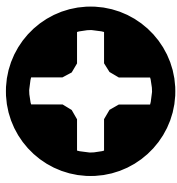

Bits for Phillips Screws



1/4" hexagon drive, suitable for D 6,3 bit holders (series 1)

851/1 IMP DC Impaktor bits



Application: Phillips screws

Drive: 1/4" hexagon, suitable for DIN ISO 1173-D 6,3 bit holders

Design: The Impaktor technology ensures an above-average service life even under extreme conditions thanks to a best-possible utilisation of the material properties and optimally designed geometry, particularly suitable for use with conventional impact drivers, the rough diamond coating reduces the danger of any slipping out of the screw head due to the enhanced frictional resistance. Take it easy toolfinder: Output colour coding (red = Phillips) and large stamp to enable the desired bit to be easily located.

| | + | mm | " |
|-------------|------|----|----|
| 05057615001 | PH 1 | 25 | 1" |
| 05057616001 | PH 2 | 25 | 1" |
| 05057617001 | PH 3 | 25 | 1" |

Bit-Box 15 Impaktor PH

| | + | | 4013288 |
|-------------|--------------|--------------|---------|
| 05057752001 | 851/1 IMP DC | 15 x PH 2x25 | 187918 |



851/1 IMP DC SB Impaktor bits

| | + | | 4013288 |
|-------------|-------------|--|---------|
| 05073916001 | 1 x PH 2x25 | | 158369 |
| 05073917001 | 1 x PH 3x25 | | 158376 |



3851/1 TS bits, stainless



Application: Phillips screws

Drive: 1/4" hexagon, suitable for DIN ISO 1173-D 6,3 bit holders

Design: Stainless steel for minimising rust, special torsion-style design to reduce premature wear. Take it easy toolfinder: Output colour coding (red = Phillips) and large stamp to enable the desired bit to be easily located.

| | + | mm | " |
|-------------|------|----|----|
| 05071010001 | PH 1 | 25 | 1" |
| 05071011001 | PH 2 | 25 | 1" |
| 05071012001 | PH 3 | 25 | 1" |

3851/1 TS SB bits, stainless

| | + | | 4013288 |
|-------------|-------------|--|---------|
| 05073610001 | 1 x PH 1x25 | | 112132 |
| 05073611001 | 1 x PH 2x25 | | 112149 |
| 05073612001 | 1 x PH 3x25 | | 112156 |



851/1 BDC bits



Application: Phillips screws

Drive: 1/4" hexagon, suitable for DIN ISO 1173-D 6,3 bit holders

Design: BiTorsion for long service life, diamond-coated for secure screw fit. Take it easy toolfinder: Output colour coding (red = Phillips) and large stamp to enable the desired bit to be easily located.

| | + | mm | " |
|-------------|------|----|----|
| 05056400001 | PH 1 | 25 | 1" |
| 05056402001 | PH 2 | 25 | 1" |
| 05056404001 | PH 3 | 25 | 1" |

851/1 BDC SB bits

| | | 4013288 |
|-------------|-------------|---------|
| 05073332001 | 1 x PH 1x25 | 029324 |
| 05073333001 | 1 x PH 2x25 | 029331 |
| 05073334001 | 1 x PH 3x25 | 029348 |
| 05073335001 | 2 x PH 2x25 | 029355 |



Tip



Impaktor-Bits



Impact-Bits are needed when a strong power tool (e.g. 18 volt impact screwdriver) is used. Impact bits were specifically developed to withstand high power tool forces.



Stainless Steel Bits



Wera stainless steel bits are manufactured out of stainless steel so unsightly rust can be avoided. The stainless steel bits from Wera are vacuum ice-hardened and have the hardness and strength needed for screw connections. There are no limitations to the industrial applications they are suitable for.



"Take it easy"

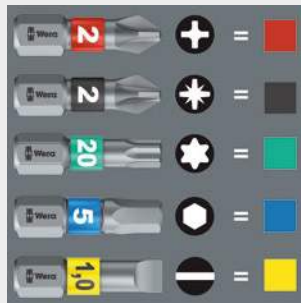

"Take it easy" tool finder with colour coding according to profiles and size stamp – for simple and rapid accessing of the required tool.





Bits for Phillips Screws



1/4" hexagon drive, suitable for D 6,3 bit holders (series 1)

851/1 BTH bits



Application: Phillips screws

Drive: 1/4" hexagon, suitable for DIN ISO 1173-D 6,3 bit holders

Design: BiTorsion for long service life, extra-hard. Take it easy toolfinder: Output colour coding (red = Phillips) and large stamp to enable the desired bit to be easily located.

| | + | mm | mm |
|-------------|------|----|----|
| 05056410001 | PH 1 | 25 | 1" |
| 05056412001 | PH 2 | 25 | 1" |
| 05056414001 | PH 3 | 25 | 1" |

851/1 ADC bits



Application: Phillips screws

Drive: 1/4" hexagon, suitable for DIN ISO 1173-D 6,3 bit holders

Design: Diamond-coated for secure screw fit, profiled version

| | + | mm | mm | mm |
|-------------|------|----|----|-----|
| 05134940001 | PH 1 | 25 | 1" | 4,5 |
| 05134941001 | PH 2 | 25 | 1" | 6,0 |
| 05134942001 | PH 3 | 25 | 1" | - |

851/1 BTZ bits



Application: Phillips screws

Drive: 1/4" hexagon, suitable for DIN ISO 1173-D 6,3 bit holders

Design: BiTorsion for long service life, extra-tough, for universal use. Take it easy toolfinder: Output colour coding (red = Phillips) and large stamp to enable the desired bit to be easily located.

| | + | mm | mm |
|-------------|------|----|----|
| 05056420001 | PH 1 | 25 | 1" |
| 05056422001 | PH 2 | 25 | 1" |
| 05056424001 | PH 3 | 25 | 1" |



Application: Phillips screws

Drive: 1/4" hexagon, suitable for DIN ISO 1173-D 6,3 bit holders

Design: Extra-hard, profiled version

| | + | mm | mm | mm |
|-------------|------|----|----|-----|
| 05134919001 | PH 1 | 25 | 1" | 4,5 |
| 05134920001 | PH 2 | 25 | 1" | 6,0 |
| 05134921001 | PH 3 | 25 | 1" | - |

Bit-Box 20 BTZ PH

| | | | |
|-------------|---|------------------------------|-------------------|
| 05057751001 | + | 851/1 BTZ PH 20 x PH 2x25 | 4013288 187956 |
|-------------|---|------------------------------|-------------------|



851/1 AH bits



Application: Phillips screws

Drive: 1/4" hexagon, suitable for DIN ISO 1173-D 6,3 bit holders

Design: Industrial version for optimum torque transfer with increased depth of penetration into the screw recess, 1/4" hexagon over the entire bit length, extra-hard, profiled version

| | | mm | " |
|-------------|------|----|----|
| 05380155001 | PH 1 | 25 | 1" |
| 05380156001 | PH 2 | 25 | 1" |
| 05380157001 | PH 3 | 25 | 1" |

851/1 RDC bits



Application: Drywall screws

Drive: 1/4" hexagon, suitable for DIN ISO 1173-D 6,3 bit holders

Design: Reduced shaft diameter, diamond-coated for secure screw fit

| | | mm | " | mm |
|-------------|------|----|----|-----|
| 05135008001 | PH 2 | 25 | 1" | 4,2 |

851/1 RH bits



Application: Phillips screws

Drive: 1/4" hexagon, suitable for DIN ISO 1173-D 6,3 bit holders

Design: Reduced shaft diameter, extra-hard, profiled version

| | | mm | " | mm |
|-------------|------|----|----|-----|
| 05380158001 | PH 1 | 25 | 1" | 4,2 |
| 05346281001 | PH 2 | 25 | 1" | 4,2 |

Tip

A-Bits



A stands for aviation. A bits are particularly hard bits with a sharp-edged profile which e.g. penetrates screw profiles full of paint (such as on fuselage panels) ensuring a dependable transfer of force between the bit and the screw.



Bits with diamond coating



The diamond coating of the DC bits lowers the danger of slipping as the minute diamond particles literally "bite" themselves into the screw head.

Bit-Box



The slide switch allows a simple and gradual removal and reinsertion of the bits. The transparent reverse side means that it is easy to know how many bits are still in the box.



"Take it easy"

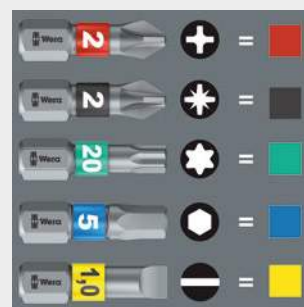

"Take it easy" tool finder with colour coding according to profiles and size stamp – for simple and rapid accessing of the required tool.





851/1 RZ bits



Application: Drywall screws

Drive: 1/4" hexagon, suitable for DIN ISO 1173-D 6,3 bit holders

Design: Reduced shaft diameter, tough, for universal use

| | | mm | " | mm |
|-------------|------|----|----|-----|
| 05135009001 | PH 2 | 25 | 1" | 4,2 |

Bit-Box 20 RZ PH

| | | 4013288 |
|-------------|-----------------------------|---------|
| 05057753001 | 851/1 RZ PH 20 x PH 2x25 | 187987 |



851/1 RZ SB bits

| | | 4013288 |
|-------------|-------------|---------|
| 05135005001 | 2 x PH 2x25 | 038456 |



Tip



Bits with reduced shaft diameter



Bits with reduced shaft diameter ensure that screws can be sunk without damaging the surface. This is particularly necessary in drywall construction applications.

Bit-Box



The slide switch allows a simple and gradual removal and reinsertion of the bits. The transparent reverse side means that it is easy to know how many bits are still in the box.





Bits for Phillips Screws



1/4" hexagon drive, suitable for D 6,3 bit holders (series 1)

851/1 TH bits



Application: Phillips screws

Drive: 1/4" hexagon, suitable for DIN ISO 1173-D 6,3 bit holders

Design: Torsion-style design to reduce premature wear, extra-hard

| | + | mm | " |
|-------------|------|----|----|
| 05056605001 | PH 1 | 25 | 1" |
| 05056610001 | PH 2 | 25 | 1" |
| 05056625001 | PH 3 | 25 | 1" |

851/1 TiN bits



Application: Phillips screws

Drive: 1/4" hexagon, suitable for DIN ISO 1173-D 6,3 bit holders

Design: TiN coating for the hardness needed e.g. in series screwdriving operations

| | + | mm | " |
|-------------|------|----|----|
| 05480171001 | PH 1 | 25 | 1" |
| 05480172001 | PH 2 | 25 | 1" |
| 05480173001 | PH 3 | 25 | 1" |

851/1 TiN SB bits

| | | 4013288 |
|-------------|--|---------|
| 05073512001 | 2 x PH 1x25 | 105806 |
| 05073513001 | 2 x PH 2x25 | 106513 |
| 05073514001 | 2 x PH 3x25 | 105820 |
| 05073515001 | 1 x PH 1x25; 1 x PH 2x25; 1 x PH 3x25 | 105837 |



851/1 TZ bits



Application: Phillips screws

Drive: 1/4" hexagon, suitable for DIN ISO 1173-D 6,3 bit holders

Design: Torsion-style design to reduce premature wear, tough, for universal use

| | + | mm | " |
|-------------|------|----|----|
| 05056505001 | PH 1 | 25 | 1" |
| 05056510001 | PH 2 | 25 | 1" |
| 05056525001 | PH 3 | 25 | 1" |

851/1 TZ SB bits

| | | 4013288 |
|-------------|---------------------------------------|---------|
| 05073323001 | 2 x PH 1x25 | 029249 |
| 05073324001 | 2 x PH 2x25 | 029256 |
| 05073325001 | 2 x PH 3x25 | 029263 |
| 05073326001 | 1 x PH 1x25; 1 x PH 2x25; 1 x PH 3x25 | 029270 |



853/1 TZ bits, ACR®



Application: Phillips screws

Drive: 1/4" hexagon, suitable for DIN ISO 1173-D 6,3 bit holders

Design: Torsion-style design to reduce premature wear, tough, for universal use, ACR® (Anti Cam-Out Ribs) prevents bits from slipping out of screw head

| | + | mm | " |
|-------------|------|----|----|
| 05056660001 | PH 1 | 25 | 1" |
| 05056662001 | PH 2 | 25 | 1" |
| 05056664001 | PH 3 | 25 | 1" |

Tip

ACR®-Bits



ACR® stands for "anti-cam-out ribs". ACR® bits have ribs at the drive tip that protect against slipping out of the screw head. It is recommended that ACR® bits are matched with ribbed ACR® screws for maximum effect. ACR® is a registered trademark of Phillips Screw Company.

TiN-Bits



TiN stands for titanium-nitride. An extremely hard coating to withstand permanent loads such as during continual screwdriving operations in series manufacturing.



TH-Bits



TH-Bits are hard bits with a torsion zone. Torsion bits absorb the damaging peak torque loads in the torsion zone. This prevents premature wear and enhances the service life of the bits.



TZ-Bits



TZ-Bits are tough bits with a torsion zone. Torsion bits absorb the damaging peak torque loads in the torsion zone. This prevents premature wear and enhances the service life of the bits.





Bits for Phillips Screws



1/4" hexagon drive, suitable for D 6,3 bit holders (series 1)

851/1 Z bits



Application: Phillips screws

Drive: 1/4" hexagon, suitable for DIN ISO 1173-D 6,3 bit holders

Design: Tough, for universal use

| | + | mm | " |
|-------------|------|----|--------|
| 05056500001 | PH 0 | 25 | 1" |
| 05072070001 | PH 1 | 25 | 1" |
| 05056507001 | PH 1 | 50 | 2" |
| 05072072001 | PH 2 | 25 | 1" |
| 05056515001 | PH 2 | 32 | 1 1/4" |
| 05056520001 | PH 2 | 50 | 2" |
| 05072074001 | PH 3 | 25 | 1" |
| 05134905001 | PH 3 | 50 | 2" |
| 05056535001 | PH 4 | 32 | 1 1/4" |

Bit-Box 20 PH

| | + | | 4013288 |
|-------------|----------|--------------|---------|
| 05057750001 | 851/1 PH | 20 x PH 2x25 | 188014 |



851/1 Z SB bits

| | + | | 4013288 |
|-------------|---------------------------------------|--|---------|
| 05073304001 | 2 x PH 1x25 | | 029058 |
| 05073305001 | 2 x PH 2x25 | | 029065 |
| 05073306001 | 2 x PH 3x25 | | 029072 |
| 05073307001 | 1 x PH 1x25; 1 x PH 2x25; 1 x PH 3x25 | | 029089 |



851/1 Z DIY bits

| | + | | 4013288 |
|-------------|--------------|--|---------|
| 05072400001 | 10 x PH 1x25 | | 115737 |
| 05072401001 | 10 x PH 2x25 | | 115744 |
| 05072402001 | 10 x PH 3x25 | | 115751 |



851/1 Z DIY 100 bits

| | + | | 4013288 |
|-------------|---------------|--|---------|
| 05072440001 | 100 x PH 1x25 | | 138460 |
| 05072441001 | 100 x PH 2x25 | | 138477 |





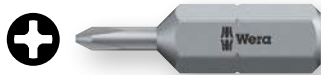

851/1 J bits



Application: Phillips screws

Drive: 1/4" hexagon, suitable for DIN ISO 1173-D 6,3 bit holders

Design: Tough, for universal use; PH 0: JCIS (Japanese Camera Industrial Standard)

| |  |  mm |  1" |  mm |
|-------------|---|---|---|---|
| 05135040001 | PH 00 | 25 | 1" | 2,0 |
| 05135041001 | PH 0 | 25 | 1" | 2,5 |
| 05135042001 | PH 1 | 25 | 1" | 3,0 |

Tip

J-Bits



J stands for Japan. J bits have been optimised to suit Asian PH screws. In particular, they are for use with very small dimensions as set out in the Japanese Camera Standard.

Bit-Box



The slide switch allows a simple and gradual removal and reinsertion of the bits. The transparent reverse side means that it is easy to know how many bits are still in the box.



Bits for Phillips Screws



1/4" hexagon drive, suitable for F 6,3 bit holders (series 4)

851/4 IMP DC Impaktor bits



Application: Phillips screws

Drive: 1/4" hexagon, suitable for DIN ISO 1173-F 6,3 bit holders

Design: The Impaktor technology ensures an above-average service life even under extreme conditions thanks to a best-possible utilisation of the material properties and optimally designed geometry, particularly suitable for use with conventional impact drivers, the rough diamond coating reduces the danger of any slipping out of the screw head due to the enhanced frictional resistance. Take it easy toolfinder: Output colour coding (red = Phillips) and large stamp to enable the desired bit to be easily located.

| | + | mm | " |
|-------------|------|----|----|
| 05057656001 | PH 2 | 50 | 2" |
| 05057657001 | PH 3 | 50 | 2" |

851/4 IMP DC SB Impaktor bits

| | + | | 4013288 |
|-------------|---|-------------|---------|
| 05073956001 | + | 1 x PH 2x50 | 158482 |
| 05073957001 | + | 1 x PH 3x50 | 158499 |



3851/4 Bits, stainless



Application: Phillips screws

Drive: 1/4" hexagon, suitable for DIN ISO 1173-F 6,3 bit holders

Design: Stainless steel for minimising rust

| | + | mm | " |
|-------------|------|----|--------|
| 05071081001 | PH 1 | 89 | 3 1/2" |
| 05071082001 | PH 2 | 89 | 3 1/2" |
| 05071083001 | PH 3 | 89 | 3 1/2" |

851/4 BDC bits



Application: Phillips screws

Drive: 1/4" hexagon, suitable for DIN ISO 1173-F 6,3 bit holders

Design: BiTorsion for long service life, diamond-coated for secure screw fit. Take it easy toolfinder: Output colour coding (red = Phillips) and large stamp to enable the desired bit to be easily located.

| | + | mm | " |
|-------------|------|----|----|
| 05059530001 | PH 1 | 50 | 2" |
| 05059532001 | PH 2 | 50 | 2" |
| 05059534001 | PH 3 | 50 | 2" |

851/4 BTH bits



Application: Phillips screws

Drive: 1/4" hexagon, suitable for DIN ISO 1173-F 6,3 bit holders

Design: BiTorsion for long service life, extra-hard. Take it easy toolfinder: Output colour coding (red = Phillips) and large stamp to enable the desired bit to be easily located.

| | + | mm | " |
|-------------|------|----|----|
| 05059540001 | PH 1 | 50 | 2" |
| 05059542001 | PH 2 | 50 | 2" |
| 05059544001 | PH 3 | 50 | 2" |

851/4 BTZ bits



Application: Phillips screws

Drive: 1/4" hexagon, suitable for DIN ISO 1173-F 6,3 bit holders

Design: BiTorsion for long service life, extra-tough, for universal use. Take it easy toolfinder: Output colour coding (red = Phillips) and large stamp to enable the desired bit to be easily located.

| | + | mm | " |
|-------------|------|----|----|
| 05059550001 | PH 1 | 50 | 2" |
| 05059552001 | PH 2 | 50 | 2" |
| 05059554001 | PH 3 | 50 | 2" |

Tip



Impaktor-Bits



Impact-Bits are needed when a strong power tool (e.g. 18 volt impact screwdriver) is used. Impact bits were specifically developed to withstand high power tool forces.



BDC-Bits



BDC-Bits are absolutely premium products. They have a softer BiTorsion zone which reduces the hardness of the shaft by about 20 % in comparison to the drive tip. This means that the peak loads that cause bit breakage and premature wear are absorbed in this zone – something which enhances the service life of the bits. The diamond coating lowers the danger of slipping as the minute diamond particles literally "bite" themselves into the screw head. B stands for BiTorsion. DC stands for diamond coated.



"Take it easy"

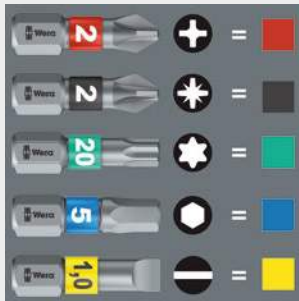

"Take it easy" tool finder with colour coding according to profiles and size stamp – for simple and rapid accessing of the required tool.





Bits for Phillips Screws



1/4" hexagon drive, suitable for F 6,3 bit holders (series 4)

851/4 ADC bits



Application: Phillips screws

Drive: 1/4" hexagon, suitable for DIN ISO 1173-F 6,3 bit holders

Design: Extra-hard, diamond-coated for secure screw fit, profiled version

| | + | mm | mm | mm |
|-------------|------|----|----|-----|
| 05134950001 | PH 1 | 50 | 2" | 4,5 |
| 05134951001 | PH 2 | 50 | 2" | 6 |
| 05134952001 | PH 3 | 50 | 2" | - |

851/4 A bits



Application: Phillips screws

Drive: 1/4" hexagon, suitable for DIN ISO 1173-F 6,3 bit holders

Design: Extra-hard, profiled version

| | + | mm | mm | mm |
|---------------------------|------|-----|--------|-----|
| 05134929001 | PH 0 | 50 | 2" | 3 |
| 05134906001 | PH 0 | 70 | 2 3/4" | 3 |
| 05134907001 | PH 0 | 89 | 3 1/2" | 3 |
| 05134908001 | PH 0 | 152 | 6" | 3 |
| 05134930001 | PH 1 | 50 | 2" | 4,5 |
| 05134370001 | PH 1 | 70 | 2 3/4" | 4,5 |
| 05134372001 | PH 1 | 89 | 3 1/2" | 4,5 |
| 05134909001 | PH 1 | 152 | 6" | 4,5 |
| 05134931001 | PH 2 | 50 | 2" | 6 |
| 05134371001 | PH 2 | 70 | 2 3/4" | 6 |
| 05134373001 | PH 2 | 89 | 3 1/2" | 6 |
| 05134910001 ¹⁾ | PH 2 | 152 | 6" | 6 |
| 05134911001 ²⁾ | PH 2 | 152 | 6" | 6 |
| 05134932001 | PH 3 | 50 | 2" | - |
| 05134912001 | PH 3 | 50 | 2" | 8 |
| 05134913001 | PH 3 | 70 | 2 3/4" | 8 |
| 05134914001 | PH 3 | 89 | 3 1/2" | 8 |
| 05134915001 | PH 3 | 152 | 6" | 8 |
| 05160983001 | PH 4 | 50 | 2" | 10 |

¹⁾ Length of drive 100 mm

²⁾ Length of drive 20 mm

851/4 RH Reduced tip bits



Application: Phillips screws

Drive: 1/4" hexagon, suitable for DIN ISO 1173-F 6,3 bit holders

Design: Reduced shaft diameter, extra-hard

| | + | mm | mm | mm |
|-------------|------|----|----|-----|
| 05380160001 | PH 1 | 50 | 2" | 4,2 |
| 05380161001 | PH 2 | 50 | 2" | 4,2 |

851/4 R Reduced tip bits



Application: Phillips screws

Drive: 1/4" hexagon, suitable for DIN ISO 1173-F 6,3 bit holders

Design: Reduced shaft diameter

| | | mm | " | mm |
|-------------|------|--------|-------|--------|
| 05160899001 | PH 2 | 50 | 2" | 3,0 |
| 05160896001 | PH 2 | 152 | 6" | 3,0 |

851/4 TH bits

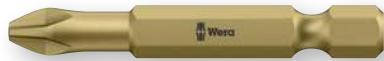

Application: Phillips screws

Drive: 1/4" hexagon, suitable for DIN ISO 1173-F 6,3 bit holders

Design: Torsion-style design to reduce premature wear, extra-hard

| | | mm | " |
|-------------|------|--------|-------|
| 05059855001 | PH 1 | 50 | 2" |
| 05059860001 | PH 2 | 50 | 2" |
| 05059865001 | PH 3 | 50 | 2" |

Tip



Bits with reduced shaft diameter



Bits with reduced shaft diameter ensure that screws can be sunk without damaging the surface. This is particularly necessary in drywall construction applications.

A-Bits



A stands for aviation. A bits are particularly hard bits with a sharp-edged profile which e.g. penetrates screw profiles full of paint (such as on fuselage panels) ensuring a dependable transfer of force between the bit and the screw.



Bits with diamond coating



The diamond coating of the DC bits lowers the danger of slipping as the minute diamond particles literally "bite" themselves into the screw head.



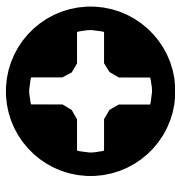

Bits for Phillips Screws

1/4" hexagon drive, suitable for F 6,3 bit holders (series 4)

851/4 TZ bits



Application: Phillips screws

Drive: 1/4" hexagon, suitable for DIN ISO 1173-F 6,3 bit holders

Design: Torsion-style design to reduce premature wear, tough, for universal use

| | | l', mm | l', " |
|-------------|------|-----------|----------|
| 05059805001 | PH 1 | 50 | 2" |
| 05059810001 | PH 2 | 50 | 2" |
| 05059815001 | PH 3 | 50 | 2" |

851/4 TZ SB bits

| 05134380001 | ⊕ | 2 x PH 1x50 | 4013288 037947 |
|-------------|---|-------------|-------------------|
| 05134381001 | ⊕ | 2 x PH 2x50 | 037954 |
| 05134382001 | ⊕ | 2 x PH 3x50 | 037961 |



851/4 J bits



Application: Phillips screws

Drive: 1/4" hexagon, suitable for DIN ISO 1173-F 6,3 bit holders

Design: Tough, for universal use

| | | l', mm | l', " | ∅ mm |
|---------------------------|-------|-----------|----------|---------|
| 05135530001 | PH 00 | 50 | 2" | 2,0 |
| 05380200001 | PH 00 | 89 | 3 1/2" | 2,0 |
| 05135531001 ¹⁾ | PH 0 | 50 | 2" | 2,5 |
| 05380201001 ¹⁾ | PH 0 | 89 | 3 1/2" | 2,5 |
| 05135532001 | PH 1 | 50 | 2" | 4,5 |
| 05380202001 | PH 1 | 89 | 3 1/2" | 4,5 |

¹⁾ Size 0 modified according to JCIS 0 (Japanese Camera Industrial Standard)

851/4 Z bits



Application: Phillips screws

Drive: 1/4" hexagon, suitable for DIN ISO 1173-F 6,3 bit holders

Design: Tough, for universal use

| | | l', mm | l', " | ∅ mm |
|-------------|------|-----------|----------|---------|
| 05059755001 | PH 1 | 70 | 2 3/4" | 4,5 |
| 05059760001 | PH 1 | 89 | 3 1/2" | 4,5 |
| 05059765001 | PH 1 | 127 | 5" | 4,5 |
| 05059766001 | PH 1 | 152 | 6" | 4,5 |
| 05059770001 | PH 2 | 70 | 2 3/4" | 6,0 |
| 05059775001 | PH 2 | 89 | 3 1/2" | 6,0 |
| 05059780001 | PH 2 | 110 | 4 3/8" | 6,0 |
| 05059785001 | PH 2 | 127 | 5" | 6,0 |
| 05059786001 | PH 2 | 152 | 6" | 6,0 |
| 05059790001 | PH 3 | 70 | 2 3/4" | - |
| 05059795001 | PH 3 | 89 | 3 1/2" | - |
| 05059800001 | PH 3 | 110 | 4 3/8" | - |
| 05059802001 | PH 3 | 152 | 6" | - |

851/4 Z SB bits

| 05073520001 | ⊕ | 1 x PH 1x89 | 4013288 105875 |
|-------------|---|-------------|-------------------|
| 05073521001 | ⊕ | 1 x PH 2x89 | 105882 |
| 05073522001 | ⊕ | 1 x PH 3x89 | 105899 |



853/4 ACR® bits



Application: Phillips screws

Drive: 1/4" hexagon, suitable for DIN ISO 1173-F 6,3 bit holders

Design: Tough, for universal use, ACR® (Anti Cam-Out Ribs) prevents bit from slipping out of screw head

| | + | mm | " | mm |
|-------------|------|----|----|-----|
| 05346285001 | PH 1 | 50 | 2" | 3,5 |
| 05346286001 | PH 2 | 50 | 2" | 5,2 |
| 05346287001 | PH 3 | 50 | 2" | 5,8 |

853/4 Harpoon ACR® bits



Application: Phillips screws

Drive: 1/4" hexagon, suitable for DIN ISO 1173-F 6,3 bit holders

Design: Reduced shaft diameter, tough, for universal use, ACR® (Anti Cam-Out Ribs) prevents bit from slipping out of screw head

| | + | mm | " | mm |
|-------------|------|-----|--------|-----|
| 05160901001 | PH 2 | 50 | 2" | 3,3 |
| 05160895001 | PH 2 | 70 | 2 3/4" | 3,3 |
| 05160908001 | PH 2 | 152 | 6" | 3,3 |

Tip

ACR®-Bits:



ACR® stands for "anti-cam-out ribs". ACR® bits have ribs at the drive tip that protect against slipping out of the screw head. It is recommended that ACR® bits are matched with ribbed ACR® screws for maximum effect. ACR® reg. trademark of Phillips Screw Company.

J-Bits



J stands for Japan. J bits have been optimised to suit Asian PH screws. In particular, they are for use with very small dimensions as set out in the Japanese Camera Standard.





Bits for Phillips Screws



Double-ended bits, 1/4" hexagon drive (series 23)

851/23 double-ended bits for Phillips screws



Application: Phillips screws
Drive: 1/4" hexagon
Design: Ball-guide groove 17 mm

| | | l, mm | l, " |
|-------------|------|----------|----------|
| 05135705001 | PH 2 | 45 | 1 25/32" |
| 05135706001 | PH 2 | 65 | 2 9/16" |



5/16" hexagon drive, suitable for D 8 bit holders or direct drive (series 2)

851/2 Z bits



Application: Phillips screws
Drive: 5/16" hexagon, suitable for DIN ISO 1173-D 8 bit holders
Design: Tough, for universal use

| | | l, mm | l, " | ∅ mm |
|-------------|------|----------|---------|---------|
| 05057705001 | PH 1 | 32 | 1 1/4" | 4,5 |
| 05057710001 | PH 2 | 32 | 1 1/4" | 6,0 |
| 05057715001 | PH 3 | 32 | 1 1/4" | 7,6 |
| 05057720001 | PH 4 | 32 | 1 1/4" | - |
| 05057725001 | PH 4 | 38 | 1 1/2" | 10,0 |



M 4 Thread drive M 4 direct drive (series 11)





851/11 Bits



Application: Phillips screws

Drive: Thread drive M 4

Design: Tough, for universal use

| |  |  mm |  mm |  mm |
|-------------|---|---|---|---|
| 05065075001 | PH 1 | 33 | 1 1/4" | 5,5 |
| 05065081001 | PH 2 | 33 | 1 1/4" | 6,0 |



M 5 Thread drive M 5 direct drive (series 12)





851/12 Bits



Application: Phillips screws

Drive: Thread drive M 5

Design: Tough, for universal use

| |  |  mm |  mm |  mm |
|-------------|---|---|---|---|
| 05065110001 | PH 2 | 33 | 1 1/4" | 7,0 |
| 05065112001 | PH 2 | 35 | 1 3/8" | 7,0 |
| 05065114001 | PH 2 | 44,5 | 1 3/4" | 6,0 |
| 05065116001 | PH 2 | 50 | 2" | 6,0 |



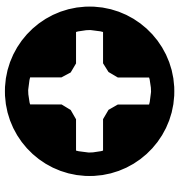

Bits for Phillips Screws



M 6 Thread drive M 6 direct drive (series 15)

851/15 Bits



Application: Phillips screws

Drive: Thread drive M 6

Design: Tough, for universal use

| | | mm | mm | mm |
|-------------|------|--------|--------|--------|
| 05065150001 | PH 2 | 33 | 1 1/4" | 8,0 |
| 05065152001 | PH 2 | 35 | 1 3/8" | 8,0 |
| 05065154001 | PH 2 | 44,5 | 1 3/4" | 8,0 |



#10/32" Thread drive #10-32 UNF direct drive (series 16)

851/16 Bits

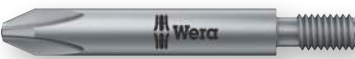

Application: Phillips screws

Drive: Thread drive #10-32 UNF

Design: Tough, for universal use

| | | mm | mm | mm |
|-------------|------|--------|--------|--------|
| 05065197001 | PH 2 | 44,5 | 1 3/4" | 6,0 |



4 mm 4 mm Halfmoon direct drive (series 9)

851/9 C J PH bits, halfmoon



Application: Phillips screws

Drive: Halfmoon, 4 mm

Design: Hard

| | | mm | mm | mm | mm | mm |
|---------------------------|--------|--------|----------|--------|--------|--------|
| 05134605001 ¹⁾ | PH 000 | 44 | 1 47/64" | 1,5 | 20 | 25/32" |
| 05134606001 ¹⁾ | PH 000 | 64 | 2 33/64" | 1,5 | 20 | 25/32" |
| 05135270001 ¹⁾ | PH 00 | 44 | 1 47/64" | 1,8 | 20 | 25/32" |
| 05135271001 ¹⁾ | PH 00 | 64 | 2 33/64" | 1,8 | 20 | 25/32" |
| 05135272001 ²⁾ | PH 0 | 44 | 1 47/64" | 1,8 | 20 | 25/32" |
| 05135273001 ²⁾ | PH 0 | 64 | 2 33/64" | 1,8 | 20 | 25/32" |
| 05135274001 ²⁾ | PH 0 | 44 | 1 47/64" | 2,0 | 20 | 25/32" |
| 05135275001 ²⁾ | PH 0 | 64 | 2 33/64" | 2,2 | 20 | 25/32" |
| 05135278001 ²⁾ | PH 0 | 44 | 1 47/64" | 2,2 | 20 | 25/32" |
| 05135276001 ¹⁾ | PH 1 | 44 | 1 47/64" | 3,0 | 20 | 25/32" |
| 05135277001 ¹⁾ | PH 1 | 64 | 2 33/64" | 3,0 | 20 | 25/32" |
| 05134607001 | PH 2 | 44 | 1 47/64" | 4,0 | - | - |
| 05134608001 | PH 2 | 64 | 2 33/64" | 4,0 | - | - |

¹⁾ Optimised for Asian PH screws

²⁾ Size 0 modified according to JCIS 0 (Japanese Camera Industrial Standard)



4 mm 4 mm HIOS direct drive (series 21)

851/21 J bits



Application: Phillips screws

Drive: HIOS 4 mm

Design: Hard

| | | mm | mm | mm |
|---------------------------|-------|--------|---------|--------|
| 05135280001 ¹⁾ | PH 00 | 40 | 1 9/16" | 1,8 |
| 05135281001 ¹⁾ | PH 00 | 60 | 2 3/8" | 1,8 |
| 05135284001 ²⁾ | PH 0 | 40 | 1 9/16" | 1,8 |
| 05135285001 ²⁾ | PH 0 | 60 | 2 3/8" | 1,8 |
| 05135286001 ²⁾ | PH 0 | 40 | 1 9/16" | 2,0 |
| 05135287001 ²⁾ | PH 0 | 60 | 2 3/8" | 2,0 |
| 05135288001 ²⁾ | PH 0 | 40 | 1 9/16" | 2,5 |
| 05135289001 ²⁾ | PH 0 | 60 | 2 3/8" | 2,5 |
| 05135290001 | PH 1 | 40 | 1 9/16" | 3,0 |
| 05135291001 | PH 1 | 60 | 2 3/8" | 3,0 |

¹⁾ Size 00 modified according to JCIS 00 (Japanese Camera Industrial Standard) modifiziert

²⁾ Size 0 modified according to JCIS 0 (Japanese Camera Industrial Standard)





Bits for Phillips Screws

 5 mm 5 mm HIOS direct drive (series 22)







851/22 J bits



Application: Phillips screws

Drive: HIOS 5 mm

Design: Hard; PH 0: JCIS (Japanese Camera Industrial Standard)

| |  |  mm |  mm |  mm |  mm |  mm |
|---------------------------|---|---|---|---|---|---|
| 05135380001 ¹⁾ | PH 00 | 60 | 2 ³ / ₈ " | 2,0 | 20 | ²⁵ / ₃₂ " |
| 05135381001 ²⁾ | PH 0 | 60 | 2 ³ / ₈ " | 2,0 | 20 | ²⁵ / ₃₂ " |
| 05135382001 ²⁾ | PH 0 | 80 | 3 ¹ / ₈ " | 2,0 | 20 | ²⁵ / ₃₂ " |
| 05135383001 ²⁾ | PH 0 | 60 | 2 ³ / ₈ " | 2,5 | 20 | ²⁵ / ₃₂ " |
| 05135384001 ²⁾ | PH 0 | 80 | 3 ¹ / ₈ " | 2,5 | 20 | ²⁵ / ₃₂ " |
| 05135385001 | PH 1 | 60 | 2 ³ / ₈ " | 3,0 | 20 | ²⁵ / ₃₂ " |
| 05135386001 | PH 1 | 80 | 3 ¹ / ₈ " | 3,0 | 20 | ²⁵ / ₃₂ " |
| 05135387001 | PH 1 | 100 | 4" | 3,0 | 20 | ²⁵ / ₃₂ " |

¹⁾ Size 00 modified according to JCIS 00 (Japanese Camera Industrial Standard) modifiziert

²⁾ Size 0 modified according to JCIS 0 (Japanese Camera Industrial Standard)



⁵/₁₆ "

5/16" external square drive (series 25)



851/25 H bits



Application: Phillips screws

Drive: ⁵/₁₆ " external square

Design: Extra-hard

| |  |  mm |  mm |
|-------------|---|---|---|
| 05380380001 | PH 1 | 29 | 1 ³ / ₁₆ " |
| 05380381001 | PH 2 | 29 | 1 ³ / ₁₆ " |
| 05380382001 | PH 3 | 29 | 1 ³ / ₁₆ " |
| 05380383001 | PH 4 | 29 | 1 ³ / ₁₆ " |



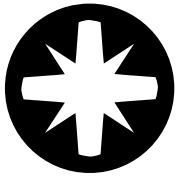

Bits for Pozidriv Screws



1/4" hexagon drive, suitable for D 6,3 bit holders (series 1)

855/1 IMP DC Impaktor bits



Application: Suitable for Pozidriv screws

Drive: 1/4" hexagon, suitable for DIN ISO 1173-D 6,3 bit holders

Design: The Impaktor technology ensures an above-average service life even under extreme conditions thanks to a best-possible utilisation of the material properties and optimally designed geometry, particularly suitable for use with conventional impact drivers, the rough diamond coating reduces the danger of any slipping out of the screw head due to the enhanced frictional resistance. Take it easy toolfinder: Output colour coding (black = Pozidriv) and large stamp to enable the desired bit to be easily located.

| | | mm | |
|-------------|------|--------|----|
| 05057620001 | PZ 1 | 25 | 1" |
| 05057621001 | PZ 2 | 25 | 1" |
| 05057622001 | PZ 3 | 25 | 1" |

Bit-Box 15 Impaktor PZ

| 05057763001 | 855/1 IMP DC | 15 x PZ 2x25 | 4013288 187901 |
|-------------|--------------|--------------|----------------|



3855/1 TS bits, stainless



Application: Suitable for Pozidriv screws

Drive: 1/4" hexagon, suitable for DIN ISO 1173-D 6,3 bit holders

Design: Stainless steel for minimising rust, special torsion-style design to reduce premature wear. Take it easy toolfinder: Output colour coding (black = Pozidriv) and large stamp to enable the desired bit to be easily located.

| | | mm | |
|-------------|------|--------|----|
| 05071020001 | PZ 1 | 25 | 1" |
| 05071021001 | PZ 2 | 25 | 1" |
| 05071022001 | PZ 3 | 25 | 1" |

3855/1 TS SB bits, stainless

| 05073613001 | 1 x PZ 1x25 | 112101 | 4013288 |
|-------------|-------------|--------|---------|
| 05073614001 | 1 x PZ 2x25 | 112118 | |
| 05073615001 | 1 x PZ 3x25 | 112125 | |



855/1 IMP DC SB Impaktor bits

| 05073921001 | 1 x PZ 2x25 | 158383 | 4013288 |
|-------------|-------------|--------|---------|
| 05073922001 | 1 x PZ 3x25 | 158390 | |



855/1 BDC bits



Application: Suitable for Pozidriv screws

Drive: 1/4" hexagon, suitable for DIN ISO 1173-D 6,3 bit holders

Design: BiTorsion for long service life, diamond-coated for secure screw fit. Take it easy toolfinder: Output colour coding (black = Pozidriv) and large stamp to enable the desired bit to be easily located.

| | | mm | |
|-------------|------|----|----|
| 05056700001 | PZ 1 | 25 | 1" |
| 05056702001 | PZ 2 | 25 | 1" |
| 05056704001 | PZ 3 | 25 | 1" |

855/1 BDC SB bits

| | | 4013288 |
|-------------|-------------|---------|
| 05073336001 | 1 x PZ 1x25 | 029362 |
| 05073337001 | 1 x PZ 2x25 | 029379 |
| 05073338001 | 1 x PZ 3x25 | 029386 |
| 05073339001 | 2 x PZ 2x25 | 029393 |



Tip



Impaktor-Bits



Impact-Bits are needed when a strong power tool (e.g. 18 volt impact screwdriver) is used. Impact bits were specifically developed to withstand high power tool forces.



BDC-Bits



BDC-Bits are absolutely premium products. They have a softer BiTorsion zone which reduces the hardness of the shaft by about 20 % in comparison to the drive tip. This means that the peak loads that cause bit breakage and premature wear are absorbed in this zone – something which enhances the service life of the bits. The diamond coating lowers the danger of slipping as the minute diamond particles literally "bite" themselves into the screw head. B stands for BiTorsion. DC stands for diamond coated.



"Take it easy"

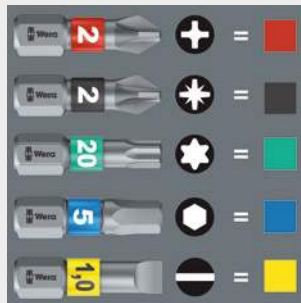

"Take it easy" tool finder with colour coding according to profiles and size stamp – for simple and rapid accessing of the required tool.



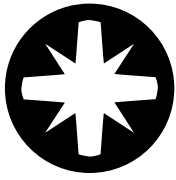

Bits for Pozidriv Screws



1/4" hexagon drive, suitable for D 6,3 bit holders (series 1)

855/1 BTH bits



Application: Suitable for Pozidriv screws

Drive: 1/4" hexagon, suitable for DIN ISO 1173-D 6,3 bit holders

Design: BiTorsion for long service life, extra-hard. Take it easy toolfinder: Output colour coding (black = Pozidriv) and large stamp to enable the desired bit to be easily located.

| | | mm | " |
|-------------|------|----|----|
| 05056710001 | PZ 1 | 25 | 1" |
| 05056712001 | PZ 2 | 25 | 1" |
| 05056714001 | PZ 3 | 25 | 1" |

Bit-Box 20 BTH PZ

| | | |
|-------------|------------------------------|-------------------|
| | | |
| 05057762001 | 855/1 BTH PZ 20 x PZ 2x25 | 4013288 187963 |



855/1 BTZ bits



Application: Suitable for Pozidriv screws

Drive: 1/4" hexagon, suitable for DIN ISO 1173-D 6,3 bit holders

Design: BiTorsion for long service life, extra-tough, for universal use. Take it easy toolfinder: Output colour coding (black = Pozidriv) and large stamp to enable the desired bit to be easily located.

| | | mm | " |
|-------------|------|----|----|
| 05056720001 | PZ 1 | 25 | 1" |
| 05056722001 | PZ 2 | 25 | 1" |
| 05056724001 | PZ 3 | 25 | 1" |

Bit-Box 20 BTZ PZ

| | | |
|-------------|------------------------------|-------------------|
| | | |
| 05057761001 | 855/1 BTZ PZ 20 x PZ 2x25 | 4013288 187970 |



855/1 RZ bits



Application: Quick-build Pozidriv screws

Drive: 1/4" hexagon, suitable for DIN ISO 1173-D 6,3 bit holders

Design: Reduced shaft diameter, tough, for universal use

| | | mm | " | mm |
|-------------|------|----|----|-----|
| 05135017001 | PZ 1 | 25 | 1" | 4,2 |
| 05135003001 | PZ 2 | 25 | 1" | 4,2 |

855/1 TH bits



Application: Suitable for Pozidriv screws

Drive: 1/4" hexagon, suitable for DIN ISO 1173-D 6,3 bit holders

Design: Torsion-style design to reduce premature wear, extra-hard

| | mm | | |
|-------------|------|----|----|
| 05056910001 | PZ 1 | 25 | 1" |
| 05056915001 | PZ 2 | 25 | 1" |
| 05056925001 | PZ 3 | 25 | 1" |

855/1 TH SB bits

| | | 4013288 |
|-------------|--|---------|
| 05073370001 | 2 x PZ 1x25 | 029638 |
| 05073371001 | 2 x PZ 2x25 | 029645 |
| 05073372001 | 2 x PZ 3x25 | 029652 |
| 05073373001 | 1 x PZ 1x25; 1 x PZ 2x25; 1 x PZ 3x25 | 029669 |



855/1 TiN bits



Application: Suitable for Pozidriv screws

Drive: 1/4" hexagon, suitable for DIN ISO 1173-D 6,3 bit holders

Design: TiN coating for the hardness needed e.g. in series screwdriving operations

| | mm | | |
|-------------|------|----|----|
| 05480221001 | PZ 1 | 25 | 1" |
| 05480222001 | PZ 2 | 25 | 1" |
| 05480223001 | PZ 3 | 25 | 1" |

855/1 TiN SB bits

| | | 4013288 |
|-------------|--|---------|
| 05073516001 | 2 x PZ 1x25 | 106445 |
| 05073517001 | 2 x PZ 2x25 | 105844 |
| 05073518001 | 2 x PZ 3x25 | 105851 |
| 05073519001 | 1 x PZ 1x25; 1 x PZ 2x25; 1 x PZ 3x25 | 105868 |

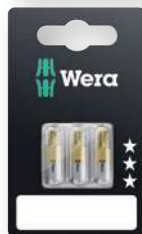
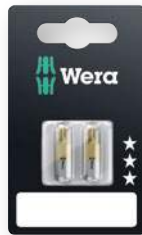

Tip



Bits with reduced shaft diameter



Bits with reduced shaft diameter ensure that screws can be sunk without damaging the surface. This is particularly necessary in drywall construction applications.

TiN-Bits



TiN stands for titanium-nitrite. An extremely hard coating to withstand permanent loads such as during continual screwdriving operations in series manufacturing.

Bit-Box

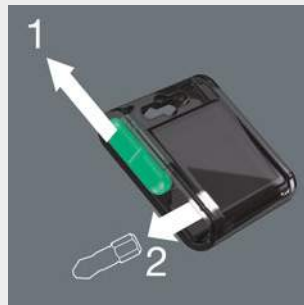

The slide switch allows a simple and gradual removal and reinsertion of the bits. The transparent reverse side means that it is easy to know how many bits are still in the box.



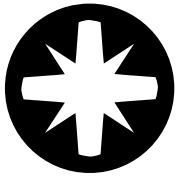

Bits for Pozidriv Screws



1/4" hexagon drive, suitable for D 6,3 bit holders (series 1)

855/1 TZ bits



Application: Suitable for Pozidriv screws

Drive: 1/4" hexagon, suitable for DIN ISO 1173-D 6,3 bit holders

Design: Torsion-style design to reduce premature wear, tough, for universal use

| | | mm | " |
|-------------|------|--------|-------|
| 05056810001 | PZ 1 | 25 | 1" |
| 05056815001 | PZ 2 | 25 | 1" |
| 05056825001 | PZ 3 | 25 | 1" |

855/1 Z bits



Application: Suitable for Pozidriv screws

Drive: 1/4" hexagon, suitable for DIN ISO 1173-D 6,3 bit holders

Design: Tough, for universal use

| | | mm | " |
|-------------|------|--------|--------|
| 05056805001 | PZ 0 | 25 | 1" |
| 05072080001 | PZ 1 | 25 | 1" |
| 05056812001 | PZ 1 | 50 | 2" |
| 05072082001 | PZ 2 | 25 | 1" |
| 05056820001 | PZ 2 | 50 | 2" |
| 05072084001 | PZ 3 | 25 | 1" |
| 05056835001 | PZ 4 | 32 | 1 1/4" |

856/1 TZ, ACR® bits



Application: Suitable for Pozidriv screws

Drive: 1/4" hexagon, suitable for DIN ISO 1173-D 6,3 bit holders

Design: Torsion-style design to reduce premature wear, tough, for universal use, ACR® (Anti Cam-Out Ribs) prevents bits from slipping out of screw head

| | | mm | " |
|-------------|------|--------|-------|
| 05056937001 | PZ 1 | 25 | 1" |
| 05056938001 | PZ 2 | 25 | 1" |
| 05056939001 | PZ 3 | 25 | 1" |

Bit-Box 20 PZ

| 05057760001 | 855/1 Z PZ 20 x PZ 2x25 | 4013288 188052 |
|-------------|----------------------------|-------------------|





855/1 Z SB bits

| 05073308001 | 2 x PZ 1x25 | 029096 |
|-------------|--|--------|
| 05073309001 | 2 x PZ 2x25 | 029102 |
| 05073310001 | 2 x PZ 3x25 | 029119 |
| 05073380001 | 1 x PZ 4x32 | 029621 |
| 05073311001 | 1 x PZ 1x25; 1 x PZ 2x25; 1 x PZ 3x25 | 029126 |





855/1 Z DIY bits

|  | |  4013288 |
|---|--------------|--|
| 05072403001 | 10 x PZ 1x25 | 115768 |
| 05072404001 | 10 x PZ 2x25 | 115775 |
| 05072405001 | 10 x PZ 3x25 | 115782 |



855/1 Z DIY 100 bits

|  | |  4013288 |
|---|---------------|--|
| 05072443001 | 100 x PZ 1x25 | 138484 |
| 05072444001 | 100 x PZ 2x25 | 138491 |



Tip

ACR®-Bits:



ACR® stands for “anti-cam-out ribs”. ACR® bits have ribs at the drive tip that protect against slipping out of the screw head. It is recommended that ACR® bits are matched with ribbed ACR® screws for maximum effect. ACR® reg. trademark of Phillips Screw Company.



TZ-Bits



TZ-Bits are tough bits with a torsion zone. Torsion bits absorb the damaging peak torque loads in the torsion zone. This prevents premature wear and enhances the service life of the bits.

Bit-Box

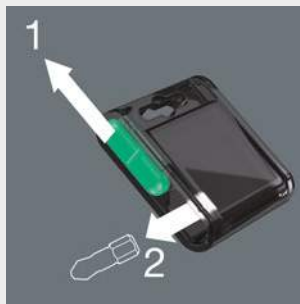

The slide switch allows a simple and gradual removal and reinsertion of the bits. The transparent reverse side means that it is easy to know how many bits are still in the box.



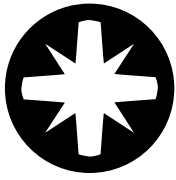

Bits for Pozidriv Screws



1/4" hexagon drive, suitable for F 6,3 bit holders (series 4)

855/4 IMP DC Impaktor bits



Application: Suitable for Pozidriv screws

Drive: 1/4" hexagon, suitable for DIN ISO 1173-F 6,3 bit holders

Design: The Impaktor technology ensures an above-average service life even under extreme conditions thanks to a best-possible utilisation of the material properties and optimally designed geometry, particularly suitable for use with conventional impact drivers, the rough diamond coating reduces the danger of any slipping out of the screw head due to the enhanced frictional resistance. Take it easy toolfinder: Output colour coding (black = Pozidriv) and large stamp to enable the desired bit to be easily located.

| | | mm | |
|-------------|------|--------|----|
| 05057661001 | PZ 2 | 50 | 2" |
| 05057662001 | PZ 3 | 50 | 2" |

3855/4 Bits, stainless



Application: Suitable for Pozidriv screws

Drive: 1/4" hexagon, suitable for DIN ISO 1173-F 6,3 bit holders

Design: Stainless steel for minimising rust

| | | mm | |
|-------------|------|--------|--------|
| 05071084001 | PZ 1 | 89 | 3 1/2" |
| 05071085001 | PZ 2 | 89 | 3 1/2" |
| 05071041001 | PZ 2 | 50 | 2" |
| 05071086001 | PZ 3 | 89 | 3 1/2" |

855/4 IMP DC Impaktor bits SB

| 05073961001 | ⊕ | 1 x PZ 2x50 | 4013288 158505 |
|-------------|---|-------------|-------------------|
| 05073962001 | ⊕ | 1 x PZ 3x50 | 158512 |





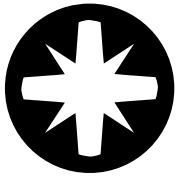

Bits for Pozidriv Screws



1/4" hexagon drive, suitable for F 6,3 bit holders (series 4)

855/4 BDC bits



Application: Suitable for Pozidriv screws

Drive: 1/4" hexagon, suitable for DIN ISO 1173-F 6,3 bit holders

Design: BiTorsion for long service life, diamond-coated for secure screw fit. Take it easy toolfinder: Output colour coding (black = Pozidriv) and large stamp to enable the desired bit to be easily located.

| | | mm | " |
|-------------|------|--------|-------|
| 05059900001 | PZ 1 | 50 | 2" |
| 05059902001 | PZ 2 | 50 | 2" |
| 05059904001 | PZ 3 | 50 | 2" |

855/4 BTH bits



Application: Suitable for Pozidriv screws

Drive: 1/4" hexagon, suitable for DIN ISO 1173-F 6,3 bit holders

Design: BiTorsion for long service life, extra-hard. Take it easy toolfinder: Output colour coding (black = Pozidriv) and large stamp to enable the desired bit to be easily located.

| | | mm | " |
|-------------|------|--------|-------|
| 05059910001 | PZ 1 | 50 | 2" |
| 05059912001 | PZ 2 | 50 | 2" |
| 05059914001 | PZ 3 | 50 | 2" |

855/4 BTZ bits



Application: Suitable for Pozidriv screws

Drive: 1/4" hexagon, suitable for DIN ISO 1173-F 6,3 bit holders

Design: BiTorsion for long service life, extra-tough, for universal use. Take it easy toolfinder: Output colour coding (black = Pozidriv) and large stamp to enable the desired bit to be easily located.

| | | mm | " |
|-------------|------|--------|-------|
| 05059920001 | PZ 1 | 50 | 2" |
| 05059922001 | PZ 2 | 50 | 2" |
| 05059924001 | PZ 3 | 50 | 2" |

855/4 TH bits



Application: Suitable for Pozidriv screws

Drive: 1/4" hexagon, suitable for DIN ISO 1173-F 6,3 bit holders

Design: Torsion-style design to reduce premature wear, extra-hard

| | | $\frac{1}{4}$ " mm | $\frac{1}{2}$ " |
|-------------|------|-----------------------|-----------------|
| 05060055001 | PZ 1 | 50 | 2" |
| 05060060001 | PZ 2 | 50 | 2" |
| 05060065001 | PZ 3 | 50 | 2" |

855/4 TZ bits



Application: Suitable for Pozidriv screws

Drive: 1/4" hexagon, suitable for DIN ISO 1173-F 6,3 bit holders

Design: Torsion-style design to reduce premature wear, tough, for universal use

| | | $\frac{1}{4}$ " mm | $\frac{1}{2}$ " |
|-------------|------|-----------------------|-----------------|
| 05060005001 | PZ 1 | 50 | 2" |
| 05060010001 | PZ 2 | 50 | 2" |
| 05060015001 | PZ 3 | 50 | 2" |

855/4 TZ SB bits

| | | $\frac{1}{4}$ " mm | $\frac{1}{2}$ " |
|-------------|-------------|-----------------------|-----------------|
| 05134384001 | 2 x PZ 1x50 | 037985 | |
| 05134385001 | 2 x PZ 2x50 | 037992 | |
| 05134386001 | 2 x PZ 3x50 | 038005 | |



855/4 Z bits



Application: Suitable for Pozidriv screws

Drive: 1/4" hexagon, suitable for DIN ISO 1173-F 6,3 bit holders

Design: Tough, for universal use

| | | $\frac{1}{4}$ " mm | $\frac{1}{2}$ " | \varnothing mm |
|-------------|------|-----------------------|-----------------|---------------------|
| 05060027001 | PZ 1 | 70 | 2 3/4" | 4,5 |
| 05060029001 | PZ 1 | 89 | 3 1/2" | 4,5 |
| 05060031001 | PZ 1 | 127 | 5" | 4,5 |
| 05060030001 | PZ 1 | 152 | 6" | 4,5 |
| 05060033001 | PZ 2 | 70 | 2 3/4" | 6,0 |
| 05060035001 | PZ 2 | 89 | 3 1/2" | 6,0 |
| 05060037001 | PZ 2 | 110 | 4 3/8" | 6,0 |
| 05060036001 | PZ 2 | 127 | 5" | 6,0 |
| 05060038001 | PZ 2 | 152 | 6" | 6,0 |
| 05060041001 | PZ 3 | 70 | 2 3/4" | - |
| 05060043001 | PZ 3 | 89 | 3 1/2" | - |
| 05060045001 | PZ 3 | 110 | 4 3/8" | - |
| 05060047001 | PZ 3 | 152 | 6" | - |

855/4 Z SB bits

| | | $\frac{1}{4}$ " mm | $\frac{1}{2}$ " | \varnothing mm |
|-------------|-------------|-----------------------|-----------------|---------------------|
| 05073523001 | 1 x PZ 1x89 | 105905 | | |
| 05073524001 | 1 x PZ 2x89 | 106452 | | |
| 05073525001 | 1 x PZ 3x89 | 105912 | | |



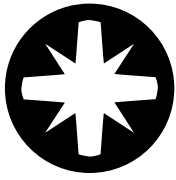

Bits for Pozidriv Screws



5/16" hexagon drive, suitable for D 8 bit holders or direct drive (series 2)

855/2 Z bits



Application: Suitable for Pozidriv screws

Drive: 5/16" hexagon, suitable for DIN ISO 1173-D 8 bit holders

Design: Tough, for universal use

| | | mm | | mm |
|-------------|------|----|--------|------|
| 05058005001 | PZ 1 | 32 | 1 1/4" | 4,5 |
| 05058010001 | PZ 2 | 32 | 1 1/4" | 6,0 |
| 05058015001 | PZ 3 | 32 | 1 1/4" | 7,6 |
| 05058020001 | PZ 4 | 32 | 1 1/4" | - |
| 05058025001 | PZ 4 | 38 | 1 1/2" | 10,0 |



M 4 Thread drive M 4 direct drive (series 11)

855/11 Bits



Application: Suitable for Pozidriv screws

Drive: Thread drive M 4

Design: Tough, for universal use

| | | mm | | mm |
|-------------|------|----|--------|-----|
| 05065090001 | PZ 1 | 33 | 1 1/4" | 5,5 |
| 05065096001 | PZ 2 | 33 | 1 1/4" | 6,0 |

 M 5 Thread drive M 5 direct drive (series 12)





855/12 Bits



Application: Suitable for Pozidriv screws

Drive: Thread drive M 5

Design: Tough, for universal use

| |  |  mm |  " |  mm |
|-------------|---|---|--|---|
| 05065125001 | PZ 2 | 33 | 1 1/4" | 7,0 |
| 05065127001 | PZ 2 | 35 | 1 3/8" | 7,0 |
| 05065129001 | PZ 2 | 44,5 | 1 3/4" | 6,0 |

 M 6 Thread drive M 6 direct drive (series 15)





855/15 Bits



Application: Suitable for Pozidriv screws

Drive: Thread drive M 6

Design: Tough, for universal use

| |  |  mm |  " |  mm |
|-------------|---|---|--|---|
| 05065167001 | PZ 2 | 35 | 1 3/8" | 8,0 |
| 05065169001 | PZ 2 | 44,5 | 1 3/4" | 8,0 |



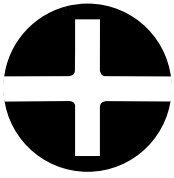

Bits for PlusMinus Screws – Phillips/Slotted



1/4" hexagon drive, suitable for F 6,3 bit holders (series 4)





851/4 PH/S PlusMinus bits



Application: PlusMinus screws (Phillips/slotted)

Drive: 1/4" hexagon suitable for DIN ISO 1173-F 6,3 bit holders

Design: PlusMinus (Phillips/slotted), tough, ideal for electrical component adjustment jobs e.g. in sheet steel or metal

| |  |  mm |  mm |  mm |
|-------------|---|---|---|---|
| 05059720001 | # 1 | 70 | 2 3/4" | 4,5 |
| 05059721001 | # 2 | 70 | 2 3/4" | 6 |

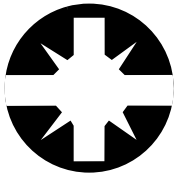

Bits for PlusMinus Screws – Pozidriv/Slotted



1/4" hexagon drive, suitable for F 6,3 bit holders (series 1)





855/4 PZ/S PlusMinus bits



Application: PlusMinus (Pozidriv/slotted) screws

Drive: 1/4" hexagon suitable for DIN ISO 1173-F 6,3 bit holders

Design: PlusMinus (slotted/Pozidriv), tough, ideal for electrical component adjustment jobs e.g. in sheet steel or metal

| |  |  mm |  mm |  mm |
|-------------|---|---|---|---|
| 05059896001 | # 1 | 70 | 2 3/4" | 4,5 |
| 05059897001 | # 2 | 70 | 2 3/4" | 6 |



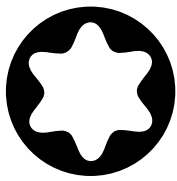

Bits for TORX® Screws



1/4" hexagon drive, suitable for D 6,3 bit holders (series 1)

867/1 IMP DC Impaktor TORX® bits



Application: TORX® socket screws

Drive: 1/4" hexagon, suitable for DIN ISO 1173-D 6,3 bit holders

Design: The Impaktor technology ensures an above-average service life even under extreme conditions thanks to a best-possible utilisation of the material properties and optimally designed geometry, particularly suitable for use with conventional impact drivers, the rough diamond coating reduces the danger of any slipping out of the screw head due to the enhanced frictional resistance. Take it easy toolfinder: Output colour coding (green = TORX®) and large stamp to enable the desired bit to be easily located.

| | | □, mm | □, " |
|-------------|-------|----------|---------|
| 05057628001 | TX 10 | 25 | 1" |
| 05057623001 | TX 15 | 25 | 1" |
| 05057624001 | TX 20 | 25 | 1" |
| 05057625001 | TX 25 | 25 | 1" |
| 05057626001 | TX 30 | 25 | 1" |
| 05057627001 | TX 40 | 25 | 1" |

3867/1 TS TORX® bits, stainless



Application: TORX® socket screws

Drive: 1/4" hexagon, suitable for DIN ISO 1173-D 6,3 bit holders

Design: Stainless steel for minimising rust, special torsion-style design to reduce premature wear. Take it easy toolfinder: Output colour coding (green = TORX®) and large stamp to enable the desired bit to be easily located.

| | | □, mm | □, " |
|-------------|-------|----------|---------|
| 05071030001 | TX 8 | 25 | 1" |
| 05071031001 | TX 9 | 25 | 1" |
| 05071032001 | TX 10 | 25 | 1" |
| 05071033001 | TX 15 | 25 | 1" |
| 05071034001 | TX 20 | 25 | 1" |
| 05071035001 | TX 25 | 25 | 1" |
| 05071036001 | TX 27 | 25 | 1" |
| 05071037001 | TX 30 | 25 | 1" |
| 05071038001 | TX 40 | 25 | 1" |

Bit-Box 15 Impaktor TX

| | | | 4013288 |
|-------------|---|-------------------------------|---------|
| 05057772001 | ⊗ | 867/1 IMP DC 15 x TX 20x25 | 187871 |
| 05057775001 | ⊗ | 867/1 IMP DC 15 x TX 25x25 | 187888 |
| 05057776001 | ⊗ | 867/1 IMP DC 15 x TX 30x25 | 187895 |



3867/1 TS SB TORX® bits, stainless

| | | | 4013288 |
|-------------|---|--------------|---------|
| 05073620001 | ⊗ | 1 x TX 10x25 | 117670 |
| 05073621001 | ⊗ | 1 x TX 15x25 | 117687 |
| 05073622001 | ⊗ | 1 x TX 20x25 | 117694 |
| 05073623001 | ⊗ | 1 x TX 25x25 | 117700 |
| 05073624001 | ⊗ | 1 x TX 27x25 | 117717 |
| 05073625001 | ⊗ | 1 x TX 30x25 | 117724 |
| 05073626001 | ⊗ | 1 x TX 40x25 | 117731 |



867/1 IMP DC SB Impaktor bits

| | | | 4013288 |
|-------------|---|--------------|---------|
| 05073924001 | ⊗ | 1 x TX 20x25 | 163240 |
| 05073925001 | ⊗ | 1 x TX 25x25 | 158406 |
| 05073926001 | ⊗ | 1 x TX 30x25 | 158413 |
| 05073927001 | ⊗ | 1 x TX 40x25 | 158420 |



867/1 BDC TORX® bits



Application: TORX® socket screws

Drive: 1/4" hexagon, suitable for DIN ISO 1173-D 6,3 bit holders

Design: BiTorsion for long service life, diamond-coated for secure screw fit. Take it easy toolfinder: Output colour coding (green = TORX®) and large stamp to enable the desired bit to be easily located.

| | | mm | " |
|-------------|-------|----|----|
| 05066100001 | TX 10 | 25 | 1" |
| 05066102001 | TX 15 | 25 | 1" |
| 05066104001 | TX 20 | 25 | 1" |
| 05066106001 | TX 25 | 25 | 1" |
| 05342920001 | TX 27 | 25 | 1" |
| 05066108001 | TX 30 | 25 | 1" |
| 05066110001 | TX 40 | 25 | 1" |

867/1 BDC SB TORX® bits

| | | 4013288 |
|-------------|--------------|---------|
| 05134374001 | 1 x TX 10x25 | 099778 |
| 05134375001 | 1 x TX 15x25 | 099785 |
| 05134376001 | 1 x TX 20x25 | 099792 |
| 05134377001 | 1 x TX 25x25 | 099808 |
| 05134378001 | 1 x TX 30x25 | 099822 |
| 05134379001 | 1 x TX 40x25 | 099815 |



Tip



Impaktor-Bits



Impact-Bits are needed when a strong power tool (e.g. 18 volt impact screwdriver) is used. Impact bits were specifically developed to withstand high power tool forces.



BDC-Bits



BDC-Bits are absolutely premium products. They have a softer BiTorsion zone which reduces the hardness of the shaft by about 20 % in comparison to the drive tip. This means that the peak loads that cause bit breakage and premature wear are absorbed in this zone – something which enhances the service life of the bits. The diamond coating lowers the danger of slipping as the minute diamond particles literally “bite” themselves into the screw head. B stands for BiTorsion. DC stands for diamond coated.



“Take it easy”

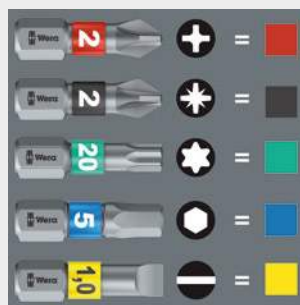

“Take it easy” tool finder with colour coding according to profiles and size stamp – for simple and rapid accessing of the required tool.



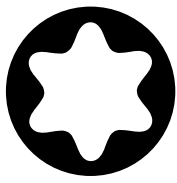

Bits for TORX® Screws



1/4" hexagon drive, suitable for D 6,3 bit holders (series 1)

867/1 BTZ TORX® bits



Application: TORX® socket screws

Drive: 1/4" hexagon, suitable for DIN ISO 1173-D 6,3 bit holders

Design: BiTorsion for long service life, extra-tough, for universal use. Take it easy toolfinder: Output colour coding (green = TORX®) and large stamp to enable the desired bit to be easily located.

| | | □ mm | □ " |
|-------------|-------|---------|--------|
| 05066120001 | TX 10 | 25 | 1" |
| 05066122001 | TX 15 | 25 | 1" |
| 05066124001 | TX 20 | 25 | 1" |
| 05066126001 | TX 25 | 25 | 1" |
| 05066128001 | TX 30 | 25 | 1" |
| 05066130001 | TX 40 | 25 | 1" |

867/1 Z TORX® HF bits with holding function



Application: TORX® socket screws

Drive: 1/4" hexagon, suitable for DIN ISO 1173-D 6,3 bit holders

Design: Holding function for TORX® screws made according to Acument Intellectual Properties specifications, tough, for universal use

| | | □ mm | □ " | ∅ mm |
|-------------|-------|---------|--------|---------|
| 05066070001 | TX 8 | 25 | 1" | 2,2 |
| 05066071001 | TX 9 | 25 | 1" | 2,4 |
| 05066072001 | TX 10 | 25 | 1" | 2,5 |
| 05066073001 | TX 15 | 25 | 1" | 3,0 |
| 05066074001 | TX 20 | 25 | 1" | 3,7 |
| 05066075001 | TX 25 | 25 | 1" | 4,1 |
| 05066076001 | TX 27 | 25 | 1" | 4,8 |
| 05066077001 | TX 30 | 25 | 1" | 5,4 |
| 05066078001 | TX 40 | 25 | 1" | 6,5 |

Bit-Box 20 BTZ TX

| | | | 4013288 |
|-------------|----------------------------------|--|---------|
| 05057771001 | 867/1 TORX® BTZ 20 x TX 20x25 | | 187932 |
| 05057774001 | 867/1 TORX® BTZ 20 x TX 25x25 | | 187949 |



867/1 TZ TORX® bits



Application: TORX® socket screws

Drive: 1/4" hexagon, suitable for DIN ISO 1173-D 6,3 bit holders

Design: Torsion-style design to reduce premature wear, tough, for universal use

| | | mm | 1" | mm |
|-------------|-------|----|----|-----|
| 05066300001 | TX 5 | 25 | 1" | 4,2 |
| 05066301001 | TX 6 | 25 | 1" | 4,2 |
| 05066302001 | TX 7 | 25 | 1" | 4,2 |
| 05066303001 | TX 8 | 25 | 1" | 4,2 |
| 05066304001 | TX 9 | 25 | 1" | 4,2 |
| 05066305001 | TX 10 | 25 | 1" | 4,2 |
| 05066308001 | TX 15 | 25 | 1" | 4,2 |
| 05066310001 | TX 20 | 25 | 1" | 4,8 |
| 05066312001 | TX 25 | 25 | 1" | 5,5 |
| 05066313001 | TX 27 | 25 | 1" | 5,5 |
| 05066315001 | TX 30 | 25 | 1" | 6,0 |
| 05066320001 | TX 40 | 25 | 1" | - |

Tip

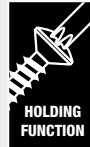

The HF profile



In tight assembly or disassembly situations, for example in engine compartments, it is not possible to securely hold the screw with the hand on the screwdriver, and the screw subsequently often gets lost. Lengthy searches or the loss of the screw (with the associated danger that could bring about) are the consequence. The HF

tools developed by Wera are ideal because they feature an optimised geometry of the original TORX® profile. The wedging forces resulting from the surface pressure between the drive tip and the screw profile mean that the screw is securely held on the tool!



BTZ-Bits



BTZ-Bits have an additional tempered BiTorsion zone, which reduces the hardness of the shaft by about 20 % in comparison to the drive tip. This means that the peak loads that cause bit breakage and premature wear are absorbed in this zone – something which enhances the service life of the bits.

Bit-Box



The slide switch allows a simple and gradual removal and reinsertion of the bits. The transparent reverse side means that it is easy to know how many bits are still in the box.



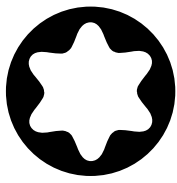

Bits for TORX® Screws



1/4" hexagon drive, suitable for D 6,3 bit holders (series 1)

867/1 TORX® bits



Application: TORX® socket screws

Drive: 1/4" hexagon, suitable for DIN ISO 1173-D 6,3 bit holders

Design: Tough, for universal use

| | | □ mm | □ " | ∅ mm |
|-------------|-------|---------|--------|---------|
| 05135140001 | TX 1 | 25 | 1" | 1,5 |
| 05135141001 | TX 2 | 25 | 1" | 1,5 |
| 05135142001 | TX 3 | 25 | 1" | 2,0 |
| 05135143001 | TX 4 | 25 | 1" | 2,0 |
| 05066492001 | TX 5 | 25 | 1" | 3,0 |
| 05066493001 | TX 6 | 25 | 1" | 3,0 |
| 05066494001 | TX 7 | 25 | 1" | 3,0 |
| 05066495001 | TX 8 | 25 | 1" | 3,0 |
| 05066496001 | TX 9 | 25 | 1" | 3,0 |
| 05066485001 | TX 10 | 25 | 1" | 4,0 |
| 05066486001 | TX 15 | 25 | 1" | 4,0 |
| 05066487001 | TX 20 | 25 | 1" | 5,0 |
| 05066488001 | TX 25 | 25 | 1" | 5,0 |
| 05066489001 | TX 27 | 25 | 1" | 6,0 |
| 05066490001 | TX 30 | 25 | 1" | 6,0 |
| 05066491001 | TX 40 | 25 | 1" | - |
| 05066325001 | TX 45 | 35 | 1 3/8" | 8,0 |
| 05066330001 | TX 50 | 35 | 1 3/8" | 9,0 |
| 05066335001 | TX 55 | 35 | 1 3/8" | 12,0 |

867/1 SB TORX® bits

| | | 4013288 |
|-------------|--|---------|
| 05073313001 | 2 x TX 10x25 | 029140 |
| 05073340001 | 2 x TX 15x25 | 029591 |
| 05073314001 | 2 x TX 20x25 | 029157 |
| 05073315001 | 2 x TX 25x25 | 029164 |
| 05073316001 | 2 x TX 30x25 | 029171 |
| 05073317001 | 2 x TX 40x25 | 029188 |
| 05073346001 | 1 x TX 50x35 | 125859 |
| 05073375001 | 1 x TX 10x25; 1 x TX 15x25; 1 x TX 20x25 | 037503 |
| 05073376001 | 1 x TX 25x25; 1 x TX 30x25; 1 x TX 40x25 | 037510 |



867/1 TORX® bits DIY

| | | 4013288 |
|-------------|---------------|---------|
| 05072406001 | 10 x TX 10x25 | 115799 |
| 05072407001 | 10 x TX 15x25 | 115805 |
| 05072408001 | 10 x TX 20x25 | 115812 |
| 05072409001 | 10 x TX 25x25 | 115829 |
| 05072410001 | 10 x TX 27x25 | 115836 |
| 05072411001 | 10 x TX 30x25 | 115843 |
| 05072412001 | 10 x TX 40x25 | 115850 |



Bit-Box 20 TX

| | | 4013288 |
|-------------|------------------------------|---------|
| 05057770001 | 867/1 TORX® 20 x TX 20x25 | 187994 |
| 05057773001 | 867/1 TORX® 20 x TX 25x25 | 188007 |



867/1 TORX® bits DIY 100

| | | 4013288 |
|-------------|----------------|---------|
| 05072446001 | 100 x TX 10x25 | 138507 |
| 05072447001 | 100 x TX 15x25 | 138514 |
| 05072448001 | 100 x TX 20x25 | 138521 |
| 05072449001 | 100 x TX 25x25 | 138538 |
| 05072450001 | 100 x TX 27x25 | 138545 |
| 05072451001 | 100 x TX 30x25 | 138552 |
| 05072452001 | 100 x TX 40x25 | 138569 |





867/1 Z TORX® Wedge bits



Application: TORX® socket screws

Drive: 1/4" hexagon, suitable for DIN ISO 1173-D 6,3 bit holders

Design: W = Wedge TORX®, tough, for universal use

| |  |  mm |  " |
|-------------|---|---|--|
| 05066450001 | TX 10 | 25 | 1" |
| 05066455001 | TX 15 | 25 | 1" |
| 05066460001 | TX 20 | 25 | 1" |
| 05066465001 | TX 25 | 25 | 1" |
| 05066470001 | TX 27 | 25 | 1" |
| 05066475001 | TX 30 | 25 | 1" |
| 05066480001 | TX 40 | 25 | 1" |





867/1 ZA TORX® bits with central pin



Application: SPAX T-STAR plus screws

Drive: 1/4" hexagon, suitable for DIN ISO 1173-D 6,3 bit holders

Design: Central pin, tough, for universal use

| |  |  mm |  " |  mm |
|-------------|---|---|--|---|
| 05066080001 | TX 10 | 25 | 1" | 4,0 |
| 05066081001 | TX 15 | 25 | 1" | 4,0 |
| 05066082001 | TX 20 | 25 | 1" | 5,0 |
| 05066083001 | TX 25 | 25 | 1" | 5,0 |
| 05066084001 | TX 30 | 25 | 1" | 6,0 |
| 05066085001 | TX 40 | 25 | 1" | - |

Tip

TORX® Wedge



The conical TORX® profile provides a better fit in the screw. Combined with a great recess depth this produces a pinch effect.

TORX® bits with central pin



The protruding pin that fits into the borehole of the screw makes it easier to centre the tool in the screw recess.

Bit-Box

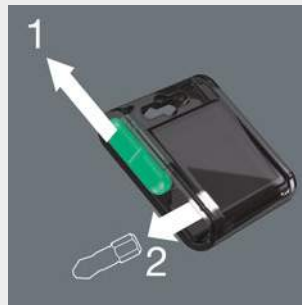

The slide switch allows a simple and gradual removal and reinsertion of the bits. The transparent reverse side means that it is easy to know how many bits are still in the box.



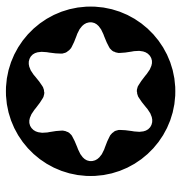

Bits for TORX® Screws

 1/4" hexagon drive, suitable for F 6,3 bit holders (series 4)

867/4 IMP DC Impaktor TORX® bits









Application: TORX® socket screws

Drive: 1/4" hexagon, suitable for DIN ISO 1173-F 6,3 bit holders

Design: The Impaktor technology ensures an above-average service life even under extreme conditions thanks to a best-possible utilisation of the material properties and optimally designed geometry, particularly suitable for use with conventional impact drivers, the rough diamond coating reduces the danger of any slipping out of the screw head due to the enhanced frictional resistance. Take it easy toolfinder: Output colour coding (green = TORX®) and large stamp to enable the desired bit to be easily located.

| |  | ⌀ mm | ℓ ₁ " |
|-------------|---|---------|---------------------|
| 05057664001 | TX 20 | 50 | 2" |
| 05057665001 | TX 25 | 50 | 2" |
| 05057666001 | TX 30 | 50 | 2" |
| 05057667001 | TX 40 | 50 | 2" |

867/4 IMP DC SB Impaktor bits

| |  | |  |
|-------------|---|--------------|---|
| 05073964001 |  | 1 x TX 20x50 | 4013288 163257 |
| 05073965001 |  | 1 x TX 25x50 | 158529 |
| 05073966001 |  | 1 x TX 30x50 | 158536 |
| 05073967001 |  | 1 x TX 40x50 | 158543 |



3867/4 TORX®, stainless



Application: TORX® socket screws

Drive: 1/4" hexagon, suitable for DIN ISO 1173-F 6,3 bit holders

Design: Stainless steel for minimising rust
Take it easy toolfinder: Output colour coding (green = TORX®) and large stamp to enable the desired bit to be easily located.

| |  | ⌀ mm | ℓ ₁ " |
|-------------|---|---------|---------------------|
| 05071046001 | TX 20 | 50 | 2" |
| 05071047001 | TX 25 | 50 | 2" |

867/4 KK TORX® bits



Application: TORX® socket screws

Drive: 1/4" hexagon, suitable for DIN ISO 1173-F 6,3 bit holders

Design: Ball end, tough, for universal use

| |  | ⌀ mm | ℓ ₁ " |
|-------------|---|---------|---------------------|
| 05059700001 | TX 10 | 89 | 3 1/2" |
| 05059701001 | TX 15 | 89 | 3 1/2" |
| 05059702001 | TX 20 | 89 | 3 1/2" |
| 05059703001 | TX 25 | 89 | 3 1/2" |
| 05059704001 | TX 30 | 89 | 3 1/2" |
| 05059705001 | TX 40 | 89 | 3 1/2" |

867/4 TORX® HF bits with holding function



Application: TORX® socket screws

Drive: 1/4" hexagon, suitable for DIN ISO 1173-F 6,3 bit holders

Design: Holding function for TORX® screws made according to Acument Intellectual Properties specifications, tough, for universal use

| | | mm | " | mm |
|-------------|-------|----|--------|-----|
| 05060080001 | TX 8 | 50 | 2" | 3,0 |
| 05060360001 | TX 10 | 89 | 3 1/2" | 4,0 |
| 05060081001 | TX 10 | 50 | 2" | 4,0 |
| 05060361001 | TX 15 | 89 | 3 1/2" | 4,0 |
| 05060082001 | TX 15 | 50 | 2" | 4,0 |
| 05060362001 | TX 20 | 89 | 3 1/2" | 4,5 |
| 05060083001 | TX 20 | 50 | 2" | 4,5 |
| 05060084001 | TX 25 | 50 | 2" | 6,0 |
| 05060363001 | TX 25 | 89 | 3 1/2" | 6,0 |
| 05060085001 | TX 27 | 50 | 2" | 6,0 |
| 05060364001 | TX 27 | 89 | 3 1/2" | 6,0 |
| 05060086001 | TX 30 | 50 | 2" | 6,0 |
| 05060365001 | TX 30 | 89 | 3 1/2" | 6,0 |
| 05060087001 | TX 40 | 50 | 2" | - |
| 05060366001 | TX 40 | 89 | 3 1/2" | - |

867/4 H TORX® bits



Application: TORX® socket screws

Drive: 1/4" hexagon, suitable for DIN ISO 1173-F 6.3 bit holders

Design: Extra-hard

| | | mm | " | mm |
|-------------|-------|----|--------|-----|
| 05135170001 | TX 5 | 50 | 2" | 3,0 |
| 05135171001 | TX 5 | 70 | 2 3/4" | 3,0 |
| 05135172001 | TX 6 | 50 | 2" | 3,0 |
| 05135180001 | TX 6 | 70 | 2 3/4" | 3,0 |
| 05135174001 | TX 8 | 50 | 2" | 3,0 |
| 05135182001 | TX 8 | 70 | 2 3/4" | 3,0 |
| 05135176001 | TX 10 | 50 | 2" | 4,0 |
| 05135184001 | TX 10 | 70 | 2 3/4" | 4,0 |
| 05135185001 | TX 15 | 50 | 2" | 4,0 |
| 05135186001 | TX 15 | 70 | 2 3/4" | 4,0 |

Tip



TORX® ball tip



The spherical drive profile means that it is possible to swivel the axis of the tool to that of the screw, and therefore enable angled, "around-the-corner" screwdriving jobs.



The HF profile



In tight assembly or disassembly situations, for example in engine compartments, it is not possible to securely hold the screw with the hand on the screwdriver, and the screw subsequently often gets lost. Lengthy searches or the loss of the screw (with the associated danger that could bring about) are the consequence. The HF tools developed by Wera are ideal because they feature an optimised geometry of the original TORX® profile. The wedging forces resulting from the surface pressure between the drive tip and the screw profile mean that the screw is securely held on the tool!

867/4 H: A vacuum-hardened bit



Vacuum hardening is the cleanest and most environmentally friendly of all hardening methods. The environment inside the vacuum chamber is unreactive, even to alloys which are especially prone to oxidation. For all grades of steel, vacuum heat treatment is the optimum heat treatment, and represents state of the art technology.



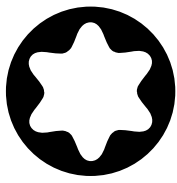

Bits for TORX® Screws



1/4" hexagon drive, suitable for F 6,3 bit holders (series 4)





867/4 Z TORX® bits





Application: TORX® socket screws

Drive: 1/4" hexagon, suitable for DIN ISO 1173-F 6,3 bit holders

Design: For universal use



| |  |  mm |  mm |  mm |
|-------------|---|---|---|---|
| 05135200001 | TX 1 | 50 | 2" | 2,0 |
| 05135201001 | TX 2 | 50 | 2" | 2,0 |
| 05135202001 | TX 3 | 50 | 2" | 2,0 |
| 05135204001 | TX 4 | 50 | 2" | 3,0 |
| 05135205001 | TX 5 | 50 | 2" | 3,0 |
| 05308428001 | TX 6 | 50 | 2" | 3,0 |
| 05134740001 | TX 6 | 70 | 2 3/4" | 3,0 |
| 05332600001 | TX 6 | 89 | 3 1/2" | 3,0 |
| 05328448001 | TX 6 | 152 | 6" | 3,0 |
| 05160830001 | TX 7 | 50 | 2" | 3,0 |
| 05345047001 | TX 7 | 70 | 2 3/4" | 3,0 |
| 05060131001 | TX 8 | 50 | 2" | 3,0 |
| 05060098001 | TX 8 | 70 | 2 3/4" | 3,0 |
| 05060185001 | TX 8 | 89 | 3 1/2" | 3,0 |
| 05060195001 | TX 8 | 152 | 6" | 3,0 |
| 05319835001 | TX 9 | 70 | 2 3/4" | 3,0 |
| 05060193001 | TX 9 | 89 | 3 1/2" | 3,0 |
| 05060194001 | TX 9 | 152 | 6" | 3,0 |
| 05060132001 | TX 10 | 50 | 2" | 4,0 |
| 05060100001 | TX 10 | 70 | 2 3/4" | 4,0 |
| 05060186001 | TX 10 | 89 | 3 1/2" | 4,0 |
| 05060196001 | TX 10 | 152 | 6" | 4,0 |
| 05060133001 | TX 15 | 50 | 2" | 4,0 |
| 05060105001 | TX 15 | 70 | 2 3/4" | 4,0 |
| 05060187001 | TX 15 | 89 | 3 1/2" | 4,0 |
| 05060197001 | TX 15 | 152 | 6" | 4,0 |
| 05060134001 | TX 20 | 50 | 2" | 4,5 |
| 05060110001 | TX 20 | 70 | 2 3/4" | 4,5 |
| 05060188001 | TX 20 | 89 | 3 1/2" | 4,5 |
| 05060198001 | TX 20 | 152 | 6" | 4,5 |
| 05060135001 | TX 25 | 50 | 2" | 6,0 |
| 05060115001 | TX 25 | 70 | 2 3/4" | 6,0 |
| 05060189001 | TX 25 | 89 | 3 1/2" | 6,0 |
| 05060199001 | TX 25 | 152 | 6" | 6,0 |
| 05060136001 | TX 27 | 50 | 2" | 6,0 |
| 05060120001 | TX 27 | 70 | 2 3/4" | 6,0 |
| 05060190001 | TX 27 | 89 | 3 1/2" | 6,0 |
| 05060200001 | TX 27 | 152 | 6" | 6,0 |
| 05060137001 | TX 30 | 50 | 2" | 6,0 |
| 05060125001 | TX 30 | 70 | 2 3/4" | 6,0 |
| 05060191001 | TX 30 | 89 | 3 1/2" | 6,0 |
| 05060201001 | TX 30 | 152 | 6" | 6,0 |
| 05060138001 | TX 40 | 50 | 2" | - |
| 05060130001 | TX 40 | 70 | 2 3/4" | - |
| 05060192001 | TX 40 | 89 | 3 1/2" | - |
| 05060202001 | TX 40 | 152 | 6" | - |

867/4 SB TORX® bits, 89 mm

|  | |  4013288 |
|---|--------------|--|
| 05073526001 | 1 x TX 10x89 | 105929 |
| 05073527001 | 1 x TX 15x89 | 105936 |
| 05073528001 | 1 x TX 20x89 | 105943 |
| 05073529001 | 1 x TX 25x89 | 105950 |
| 05073530001 | 1 x TX 30x89 | 105967 |
| 05073531001 | 1 x TX 40x89 | 105974 |



867/4 SB TORX® bits, 50 mm

|  | |  4013288 |
|---|--------------|--|
| 05073720001 | 2 x TX 10x50 | 132789 |
| 05073721001 | 2 x TX 15x50 | 132796 |
| 05073722001 | 2 x TX 20x50 | 132802 |
| 05073723001 | 2 x TX 25x50 | 132826 |
| 05073724001 | 2 x TX 30x50 | 132833 |





5/16" hexagon drive, suitable for D 8 bit holders or direct drive (series 2)

867/2 Z TORX® bits



Application: TORX® socket screws

Drive: 5/16" hexagon, suitable for DIN ISO 1173-D 8 bit holders

Design: Tough, for universal use

| | | mm | " | mm |
|-------------|-------|-----|--------|------|
| 05066901001 | TX 20 | 35 | 1 3/8" | 4,5 |
| 05066930001 | TX 20 | 50 | 2" | 4,5 |
| 05066945001 | TX 20 | 70 | 2 3/4" | 4,5 |
| 05066935001 | TX 20 | 100 | 4" | 4,5 |
| 05066900001 | TX 25 | 35 | 1 3/8" | 5,8 |
| 05066931001 | TX 25 | 50 | 2" | 5,8 |
| 05066946001 | TX 25 | 70 | 2 3/4" | 5,8 |
| 05066936001 | TX 25 | 100 | 4" | 5,8 |
| 05066902001 | TX 27 | 35 | 1 3/8" | 5,8 |
| 05066932001 | TX 27 | 50 | 2" | 5,8 |
| 05066937001 | TX 27 | 100 | 4" | 5,8 |
| 05066905001 | TX 30 | 35 | 1 3/8" | 6,0 |
| 05066933001 | TX 30 | 50 | 2" | 6,0 |
| 05066947001 | TX 30 | 70 | 2 3/4" | 6,0 |
| 05066938001 | TX 30 | 100 | 4" | 6,0 |
| 05066910001 | TX 40 | 35 | 1 3/8" | 7,0 |
| 05066934001 | TX 40 | 50 | 2" | 7,0 |
| 05066948001 | TX 40 | 70 | 2 3/4" | 7,0 |
| 05066939001 | TX 40 | 100 | 4" | 7,0 |
| 05066915001 | TX 45 | 35 | 1 3/8" | - |
| 05066940001 | TX 45 | 50 | 2" | - |
| 05066949001 | TX 45 | 70 | 2 3/4" | - |
| 05066942001 | TX 45 | 100 | 4" | - |
| 05066920001 | TX 50 | 35 | 1 3/8" | - |
| 05066941001 | TX 50 | 50 | 2" | - |
| 05066950001 | TX 50 | 70 | 2 3/4" | - |
| 05066943001 | TX 50 | 100 | 4" | - |
| 05066925001 | TX 55 | 35 | 1 3/8" | 12,0 |
| 05136220001 | TX 60 | 35 | 1 3/8" | 14,0 |



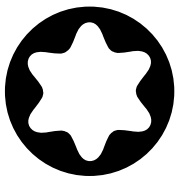

Bits for TORX® Screws



M 4 Thread drive M 4 direct drive (series 11)





867/11 TORX® bits



Application: TORX® screws

Drive: Thread drive M 4

Design: Tough, for universal use

| |  |  mm |  mm |  mm |
|-------------|---|---|---|---|
| 05064140001 | TX 8 | 33 | 1 1/4" | 6,0 |
| 05064144001 | TX 10 | 33 | 1 1/4" | 6,0 |
| 05064146001 | TX 15 | 33 | 1 1/4" | 6,0 |



M 5 Thread drive M 5 direct drive (series 12)





867/12 TORX® bits



Application: TORX® socket screws

Drive: Thread drive M 5

Design: Tough, for universal use





| |  |  mm |  mm |  mm |
|-------------|---|---|---|---|
| 05064148001 | TX 10 | 45 | 1 3/4" | 6,0 |
| 05064150001 | TX 15 | 45 | 1 3/4" | 6,0 |
| 05064155001 | TX 20 | 45 | 1 3/4" | 6,0 |
| 05064160001 | TX 25 | 45 | 1 3/4" | 6,0 |

 M 6 Thread drive M 6 direct drive (series 15)

867/15 TORX® bits



Application: TORX® screws
Drive: Thread drive M 6
Design: Tough, for universal use





| |  |  mm |  " |  mm |
|-------------|---|---|--|---|
| 05064166001 | TX 10 | 45 | 1 3/4" | 8,0 |
| 05064168001 | TX 15 | 45 | 1 3/4" | 8,0 |
| 05064170001 | TX 20 | 45 | 1 3/4" | 8,0 |
| 05064175001 | TX 25 | 45 | 1 3/4" | 8,0 |
| 05064180001 | TX 30 | 45 | 1 3/4" | 8,0 |

 #10/32" Thread drive #10-32 UNF direct drive (series 16)

867/16 TORX® bits



Application: TORX® screws
Drive: Thread drive #10-32 UNF
Design: Tough, for universal use

| |  |  mm |  " |  mm |
|-------------|---|---|--|---|
| 05064185001 | TX 10 | 45 | 1 3/4" | 6,0 |
| 05064190001 | TX 15 | 45 | 1 3/4" | 6,0 |
| 05064200001 | TX 20 | 45 | 1 3/4" | 6,0 |



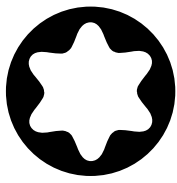





Bits for TORX® Screws

4 mm 4 mm Halfmoon direct drive (series 9)

867/9 C TORX® bits, halfmoon



Application: TORX® socket screws
Drive: Halfmoon, 4 mm
Design: Precision hardened for sensitive applications







| |  |  mm |  mm |  mm |
|-------------|---|---|---|---|
| 05135220001 | TX 1 | 44 | 1 ⁴⁷ / ₆₄ " | 1,5 |
| 05135221001 | TX 2 | 44 | 1 ⁴⁷ / ₆₄ " | 1,5 |
| 05135222001 | TX 3 | 44 | 1 ⁴⁷ / ₆₄ " | 1,7 |
| 05345352001 | TX 4 | 44 | 1 ⁴⁷ / ₆₄ " | 1,8 |
| 05345018001 | TX 4 | 64 | 2 ³³ / ₆₄ " | 2,0 |
| 05345351001 | TX 5 | 44 | 1 ⁴⁷ / ₆₄ " | 3,0 |
| 05345032001 | TX 5 | 64 | 2 ³³ / ₆₄ " | 2,0 |
| 05314753001 | TX 5 | 70 | 2 ³ / ₄ " | 2,0 |
| 05345350001 | TX 6 | 44 | 1 ⁴⁷ / ₆₄ " | 3,0 |
| 05345056001 | TX 6 | 64 | 2 ³³ / ₆₄ " | 2,0 |
| 05332610001 | TX 6 | 70 | 2 ³ / ₄ " | 3,0 |
| 05345035001 | TX 7 | 64 | 2 ³³ / ₆₄ " | 2,3 |
| 05345026001 | TX 8 | 44 | 1 ⁴⁷ / ₆₄ " | 3,0 |
| 05345028001 | TX 8 | 64 | 2 ³³ / ₆₄ " | 3,0 |
| 05332609001 | TX 8 | 70 | 2 ³ / ₄ " | 3,0 |
| 05332607001 | TX 10 | 70 | 2 ³ / ₄ " | 3,0 |

4 mm 4 mm HIOS direct drive (series 21)

867/21 TORX® bits



Application: TORX® socket screws
Drive: HIOS 4 mm
Design: Precision hardened for sensitive applications

| |  |  mm |  mm |  mm |  mm |  mm |
|---------------------------|---|---|---|---|---|---|
| 05135400001 ¹⁾ | TX 1 | 40 | 1 ⁹ / ₁₆ " | 1,5 | 20 | ²⁵ / ₃₂ " |
| 05135401001 ¹⁾ | TX 2 | 40 | 1 ⁹ / ₁₆ " | 1,5 | 20 | ²⁵ / ₃₂ " |
| 05135402001 ¹⁾ | TX 3 | 40 | 1 ⁹ / ₁₆ " | 1,7 | 20 | ²⁵ / ₃₂ " |
| 05135403001 | TX 4 | 40 | 1 ⁹ / ₁₆ " | 1,8 | 20 | ²⁵ / ₃₂ " |
| 05135404001 | TX 5 | 40 | 1 ⁹ / ₁₆ " | 2,0 | 20 | ²⁵ / ₃₂ " |
| 05135405001 | TX 6 | 40 | 1 ⁹ / ₁₆ " | 2,0 | 20 | ²⁵ / ₃₂ " |
| 05135406001 | TX 7 | 40 | 1 ⁹ / ₁₆ " | 2,5 | 20 | ²⁵ / ₃₂ " |
| 05135407001 | TX 8 | 40 | 1 ⁹ / ₁₆ " | 3,0 | 20 | ²⁵ / ₃₂ " |
| 05135408001 | TX 9 | 40 | 1 ⁹ / ₁₆ " | 3,0 | 20 | ²⁵ / ₃₂ " |
| 05135409001 | TX 10 | 40 | 1 ⁹ / ₁₆ " | 3,0 | 20 | ²⁵ / ₃₂ " |

¹⁾ Delivery on request.









 5 mm 5 mm HIOS direct drive (series 22)

867/22 TORX® bits



Application: TORX® screws
Drive: HIOS 5 mm
Design: Tough, for universal use

| |  |  mm |  mm |  mm |  mm |  mm |
|-------------|---|---|---|---|---|---|
| 05135420001 | TX 5 | 60 | 2 3/8" | 2,0 | 20 | 25/32" |
| 05135421001 | TX 6 | 60 | 2 3/8" | 2,5 | 20 | 25/32" |
| 05135422001 | TX 7 | 60 | 2 3/8" | 2,5 | 20 | 25/32" |
| 05135423001 | TX 8 | 60 | 2 3/8" | 3,0 | 20 | 25/32" |
| 05135424001 | TX 9 | 60 | 2 3/8" | 3,0 | 20 | 25/32" |
| 05135425001 | TX 10 | 60 | 2 3/8" | 3,0 | 20 | 25/32" |



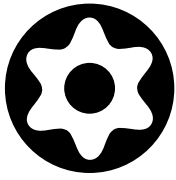

Bits for Tamper-proof TORX® BO Screws with safety pin



1/4" hexagon drive, suitable for D 6,3 bit holders (series 1)

867/1 Z TORX® BO bits



Application: TORX® socket screws with safety pin (BO = with bore hole)

Drive: 1/4" hexagon, suitable for DIN ISO 1173-D 6,3 bit holders

Design: TORX® with bore hole, tough, for universal use

| |  | ∅, mm | ∅, " |
|-------------|---|----------|---------|
| 05066497001 | TX 7 | 25 | 1" |
| 05066498001 | TX 8 | 25 | 1" |
| 05066499001 | TX 9 | 25 | 1" |
| 05066500001 | TX 10 | 25 | 1" |
| 05066505001 | TX 15 | 25 | 1" |
| 05066510001 | TX 20 | 25 | 1" |
| 05066515001 | TX 25 | 25 | 1" |
| 05066520001 | TX 27 | 25 | 1" |
| 05066525001 | TX 30 | 25 | 1" |
| 05066530001 | TX 40 | 25 | 1" |



1/4" hexagon drive, suitable for F 6,3 bit holders (series 4)

3867/4 TORX® BO bits with bore hole, stainless



Application: TORX® socket screws with safety pin (BO = with bore hole)

Drive: 1/4" hexagon, suitable for DIN ISO 1173-F 6,3 bit holders

Design: Stainless steel for minimising rust

| | | □, mm | □, mm | ∅ mm |
|-------------|----------|----------|----------|---------|
| 05071089001 | TX 10 BO | 89 | 3 1/2" | 4,0 |
| 05071090001 | TX 15 BO | 89 | 3 1/2" | 4,0 |
| 05071091001 | TX 20 BO | 89 | 3 1/2" | 4,5 |
| 05071092001 | TX 25 BO | 89 | 3 1/2" | 5,5 |
| 05071094001 | TX 30 BO | 89 | 3 1/2" | 6,0 |

867/4 Z TORX® BO bits with bore hole



Application: TORX® socket screws with safety pin (BO = with bore hole)

Drive: 1/4" hexagon, suitable for DIN ISO 1173-F 6,3 bit holders

Design: TORX® with bore hole, tough, for universal use

| | | □, mm | □, mm | ∅ mm |
|-------------|-------|----------|----------|---------|
| 05060139001 | TX 8 | 70 | 2 3/4" | 3,0 |
| 05060048001 | TX 8 | 89 | 3 1/2" | 3,0 |
| 05060049001 | TX 9 | 89 | 3 1/2" | 3,0 |
| 05060140001 | TX 10 | 70 | 2 3/4" | 4,0 |
| 05060050001 | TX 10 | 89 | 3 1/2" | 4,0 |
| 05060141001 | TX 15 | 70 | 2 3/4" | 4,0 |
| 05060051001 | TX 15 | 89 | 3 1/2" | 4,0 |
| 05060142001 | TX 20 | 70 | 2 3/4" | 4,5 |
| 05060052001 | TX 20 | 89 | 3 1/2" | 4,5 |
| 05060143001 | TX 25 | 70 | 2 3/4" | 6,0 |
| 05060053001 | TX 25 | 89 | 3 1/2" | 6,0 |
| 05060144001 | TX 27 | 70 | 2 3/4" | 6,0 |
| 05060057001 | TX 27 | 89 | 3 1/2" | 6,0 |
| 05060145001 | TX 30 | 70 | 2 3/4" | 6,0 |
| 05060054001 | TX 30 | 89 | 3 1/2" | 6,0 |
| 05060146001 | TX 40 | 70 | 2 3/4" | - |
| 05060056001 | TX 40 | 89 | 3 1/2" | - |



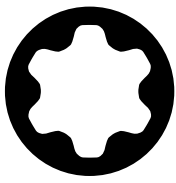

Bits for TORX PLUS® Screws



1/4" hexagon drive, suitable for D 6,3 bit holders (series 1)

867/1 IP TORX PLUS® bits



Application: TORX PLUS® socket screws

Drive: 1/4" hexagon, suitable for DIN ISO 1173-D 6,3 bit holders

Design: Tough, for universal use

| |  | □, mm | □, " |
|-------------|---|----------|---------|
| 05135120001 | 1 IP | 25 | 1" |
| 05135121001 | 2 IP | 25 | 1" |
| 05160956001 | 3 IP | 25 | 1" |
| 05134695001 | 4 IP | 25 | 1" |
| 05066272001 | 5 IP | 25 | 1" |
| 05066274001 | 6 IP | 25 | 1" |
| 05066276001 | 7 IP | 25 | 1" |
| 05066278001 | 8 IP | 25 | 1" |
| 05066279001 | 9 IP | 25 | 1" |
| 05066280001 | 10 IP | 25 | 1" |
| 05066282001 | 15 IP | 25 | 1" |
| 05066284001 | 20 IP | 25 | 1" |
| 05066286001 | 25 IP | 25 | 1" |
| 05066287001 | 27 IP | 25 | 1" |
| 05066288001 | 30 IP | 25 | 1" |
| 05066290001 | 40 IP | 25 | 1" |



1/4" hexagon drive, suitable for F 6,3 bit holders (series 4)





867/4 IP TORX PLUS® bits



Application: TORX PLUS® socket screws

Drive: 1/4" hexagon, suitable for DIN ISO 1173-F 6,3 bit holders

Design: Tough, for universal use

| |  |  mm |  " |  mm |
|-------------|---|---|--|---|
| 05134664001 | 1 IP | 50 | 2" | 2,0 |
| 05134665001 | 2 IP | 50 | 2" | 2,0 |
| 05134668001 | 3 IP | 50 | 2" | 2,0 |
| 05134691001 | 4 IP | 50 | 2" | 3,0 |
| 05134678001 | 5 IP | 50 | 2" | 3,0 |
| 05134680001 | 6 IP | 50 | 2" | 3,0 |
| 05134667001 | 6 IP | 89 | 3 1/2" | 3,0 |
| 05134690001 | 6 IP | 152 | 6" | 3,0 |
| 05134681001 | 7 IP | 50 | 2" | 3,0 |
| 05134679001 | 8 IP | 50 | 2" | 3,0 |
| 05134670001 | 8 IP | 89 | 3 1/2" | 3,0 |
| 05134682001 | 8 IP | 152 | 6" | 3,0 |
| 05160917001 | 9 IP | 50 | 2" | 3,0 |
| 05134669001 | 9 IP | 89 | 3 1/2" | 3,0 |
| 05134683001 | 10 IP | 50 | 2" | 4,0 |
| 05134684001 | 10 IP | 70 | 2 3/4" | 4,0 |
| 05134671001 | 10 IP | 89 | 3 1/2" | 4,0 |
| 05134685001 | 15 IP | 50 | 2" | 4,0 |
| 05134686001 | 15 IP | 70 | 2 3/4" | 4,0 |
| 05134672001 | 15 IP | 89 | 3 1/2" | 4,0 |
| 05134687001 | 20 IP | 50 | 2" | 4,5 |
| 05134688001 | 20 IP | 70 | 2 3/4" | 4,5 |
| 05134673001 | 20 IP | 89 | 3 1/2" | 4,5 |
| 05134674001 | 25 IP | 89 | 3 1/2" | 6,0 |
| 05134675001 | 27 IP | 89 | 3 1/2" | 6,0 |
| 05320430001 | 30 IP | 50 | 2" | 6,0 |
| 05134676001 | 30 IP | 89 | 3 1/2" | 6,0 |
| 05134677001 | 40 IP | 89 | 3 1/2" | - |



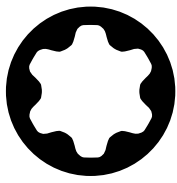







Bits for TORX PLUS® Screws

 4 mm 4 mm Halfmoon direct drive (series 9)

867/9 C IP TORX PLUS® bits, halfmoon



Application: TORX PLUS® screws
Drive: Halfmoon, 4 mm
Design: Precision hardened for sensitive applications







| |  |  mm |  " |  mm |  mm |  " |
|-------------|---|---|--|---|---|--|
| 05135230001 | 1 IP | 44 | 1 47/64 | 1,5 | 20 | 25/32 |
| 05135231001 | 2 IP | 44 | 1 47/64 | 1,5 | 20 | 25/32 |
| 05135232001 | 3 IP | 44 | 1 47/64 | 1,7 | 20 | 25/32 |
| 05326310001 | 4 IP | 44 | 1 47/64 | 2,0 | 20 | 25/32 |
| 05345019001 | 4 IP | 64 | 2 33/64 | 2,0 | 20 | 25/32 |
| 05135233001 | 5 IP | 44 | 1 47/64 | 2,0 | 20 | 25/32 |
| 05332612001 | 5 IP | 70 | 2 3/4 | 3,0 | 20 | 25/32 |
| 05344900001 | 6 IP | 44 | 1 47/64 | 2,25 | 20 | 25/32 |
| 05135234001 | 8 IP | 44 | 1 47/64 | 3,0 | 20 | 25/32 |
| 05332606001 | 8 IP | 70 | 2 3/4 | 3,0 | 20 | 25/32 |
| 05135235001 | 10 IP | 44 | 1 47/64 | 3,0 | 20 | 25/32 |

 4 mm 4 mm HIOS direct drive (series 21)

867/21 IP TORX PLUS® bits



Application: TORX PLUS® screws
Drive: HIOS 4 mm
Design: Precision hardened for sensitive applications

| |  |  mm |  " |  mm |  mm |  " |
|---------------------------|---|---|--|---|---|--|
| 05135430001 ¹⁾ | 1 IP | 40 | 1 9/16 | 1,5 | 20 | 25/32 |
| 05135431001 ¹⁾ | 2 IP | 40 | 1 9/16 | 1,5 | 20 | 25/32 |
| 05135432001 ¹⁾ | 3 IP | 40 | 1 9/16 | 1,7 | 20 | 25/32 |
| 05302402001 | 4 IP | 40 | 1 9/16 | 1,8 | 20 | 25/32 |
| 05302403001 | 5 IP | 40 | 1 9/16 | 2,0 | 20 | 25/32 |
| 05302400001 | 6 IP | 40 | 1 9/16 | 2,0 | 20 | 25/32 |
| 05135433001 | 7 IP | 40 | 1 9/16 | 2,5 | 20 | 25/32 |
| 05135434001 | 8 IP | 40 | 1 9/16 | 3,0 | 20 | 25/32 |
| 05135435001 | 9 IP | 40 | 1 9/16 | 3,0 | 20 | 25/32 |
| 05135436001 | 10 IP | 40 | 1 9/16 | 3,0 | 20 | 25/32 |







¹⁾ Delivery on request.

 5 mm 5 mm HIOS direct drive (series 22)

867/22 IP TORX PLUS® bits



Application: TORX PLUS® screws
Drive: HIOS 5 mm
Design: Precision hardened for sensitive applications

| |  |  mm |  " |  mm |  mm |  " |
|-------------|---|---|--|---|---|--|
| 05135440001 | 5 IP | 60 | 2 3/8 | 2,0 | 20 | 25/32 |
| 05344280001 | 6 IP | 60 | 2 3/8 | 2,5 | 20 | 25/32 |
| 05135441001 | 7 IP | 60 | 2 3/8 | 2,5 | 20 | 25/32 |
| 05134500001 | 8 IP | 60 | 2 3/8 | 3,0 | 20 | 25/32 |
| 05344281001 | 8 IP | 80 | 3 1/8 | 3,0 | 20 | 25/32 |
| 05135442001 | 9 IP | 60 | 2 3/8 | 3,0 | 20 | 25/32 |
| 05135443001 | 10 IP | 60 | 2 3/8 | 3,0 | 20 | 25/32 |
| 05344282001 | 10 IP | 80 | 3 1/8 | 3,0 | 20 | 25/32 |



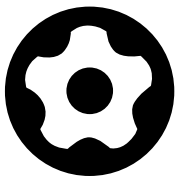

Bits for Tamper-proof TORX PLUS® IPR Screws



1/4" hexagon drive, suitable for D 6,3 bit holders (series 1)



867/1 IPR TORX PLUS® bits with bore hole



Application: TORX PLUS® IPR socket screws with safety pin

Drive: 1/4" hexagon, suitable for DIN ISO 1173-D 6,3 bit holders

Design: Tough, for universal use

| |  |  mm |  |
|-------------|---|---|---|
| 05134699001 | 8 IPR | 25 | 1" |
| 05134698001 | 9 IPR | 25 | 1" |
| 05134700001 | 10 IPR | 25 | 1" |
| 05134701001 | 15 IPR | 25 | 1" |
| 05134702001 | 20 IPR | 25 | 1" |
| 05134703001 | 25 IPR | 25 | 1" |
| 05134704001 | 27 IPR | 25 | 1" |
| 05134705001 | 30 IPR | 25 | 1" |
| 05134706001 | 40 IPR | 35 | 1 3/8" |
| 05134707001 | 45 IPR | 35 | 1 3/8" |





1/4" hexagon drive, suitable for F 6,3 bit holders (series 4)

867/4 IPR TORX PLUS® bits with bore hole



Application: TORX PLUS® IPR socket screws with safety pin

Drive: 1/4" hexagon, suitable for DIN ISO 1173-F 6,3 bit holders

Design: Tough, for universal use

| | | l, mm | l, " | ∅ mm |
|---------------------------|--------|----------|---------|---------|
| 05134600001 ¹⁾ | 1 IPR | 50 | 2" | 2,0 |
| 05134601001 ¹⁾ | 3 IPR | 50 | 2" | 2,0 |
| 05134602001 ¹⁾ | 5 IPR | 50 | 2" | 3,0 |
| 05134603001 ¹⁾ | 6 IPR | 50 | 2" | 3,0 |
| 05134604001 | 8 IPR | 50 | 2" | 3,0 |
| 05160821001 | 10 IPR | 50 | 2" | 4,0 |
| 05134657001 | 10 IPR | 89 | 3 1/2" | 4,0 |
| 05134654001 | 15 IPR | 50 | 2" | 4,0 |
| 05134720001 | 15 IPR | 89 | 3 1/2" | 4,0 |
| 05204126001 | 20 IPR | 50 | 2" | 4,5 |
| 05259135001 | 20 IPR | 89 | 3 1/2" | 4,5 |
| 05134655001 | 25 IPR | 50 | 2" | 6,0 |
| 05134722001 | 25 IPR | 89 | 3 1/2" | 6,0 |
| 05134656001 | 27 IPR | 50 | 2" | 6,0 |
| 05134658001 | 27 IPR | 89 | 3 1/2" | 6,0 |
| 05134732001 | 30 IPR | 50 | 2" | 6,0 |
| 05134723001 | 30 IPR | 89 | 3 1/2" | 6,0 |

¹⁾ Without bore hole



4 mm 4 mm Halfmoon direct drive (series 9)

867/9 IPR TORX PLUS® bits



Application: TORX PLUS® IPR socket screws

Drive: Halfmoon, 4 mm

Design: Tough, for universal use

| | | l, mm | l, " | ∅ mm |
|-------------|-------|----------|----------|---------|
| 05200495001 | 1 IPR | 44 | 1 47/64" | 1,5 |
| 05060380001 | 1 IPR | 44 | 1 47/64" | 1,8 |
| 05135226001 | 1 IPR | 64 | 2 33/64" | 1,5 |
| 05135228001 | 3 IPR | 44 | 1 47/64" | 1,8 |
| 05135229001 | 3 IPR | 64 | 2 33/64" | 1,8 |



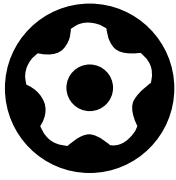

Bits for Tamper-proof TORX PLUS® IPR Screws

 4 mm 4 mm HIOS direct drive (series 21)





867/21 IPR TORX PLUS® bits



Application: TORX PLUS® IPR socket screws

Drive: HIOS 4 mm

Design: Tough, for universal use

| |  |  mm |  mm |  mm |
|-------------|---|---|---|---|
| 05300025001 | 1 IPR | 40 | 1 ³⁷ / ₆₄ " | 1,8 |
| 05300037001 | 1 IPR | 60 | 2 ³ / ₈ " | 1,8 |

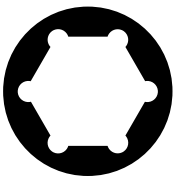

Bits for ASSY® Screws

 1/4" hexagon drive, suitable for D 6,3 bit holders (series 1)



864/1 BTZ SIT bits



Application: ASSY® screws

Drive: 1/4" hexagon, suitable for DIN ISO 1173-D 6,3 bit holders

Design: BiTorsion for long service life, extra-tough, for universal use

| |  |  mm |  " |
|-------------|---|---|--|
| 05066040001 | SIT 10 | 25 | 1" |
| 05066041001 | SIT 20 | 25 | 1" |
| 05066042001 | SIT 25 | 25 | 1" |
| 05066043001 | SIT 30 | 25 | 1" |



864/1 Z SIT bits



Application: ASSY® screws

Drive: 1/4" hexagon, suitable for DIN ISO 1173-D 6,3 bit holders

Design: Tough, for universal use

| |  |  mm |  " |
|-------------|---|---|--|
| 05066030001 | SIT 10 | 25 | 1" |
| 05066031001 | SIT 20 | 25 | 1" |
| 05066032001 | SIT 25 | 25 | 1" |
| 05066033001 | SIT 30 | 25 | 1" |



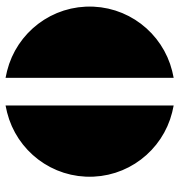

Bits for Slotted Screws



1/4" hexagon drive, suitable for D 6,3 bit holders (series 1)

3800/1 TS bits for slotted screws, stainless



Application: Slotted screws

Drive: 1/4" hexagon, suitable for DIN ISO 1173-D 6,3 bit holders

Design: Stainless steel for minimising rust, special torsion-style design to reduce premature wear. Take it easy toolfinder: Output colour coding (yellow = slotted) and large stamp to enable the desired bit to be easily located.

| | mm | mm | mm | " |
|-------------|-----|-----|----|----|
| 05071000001 | 0,8 | 5,5 | 25 | 1" |
| 05071001001 | 1,0 | 5,5 | 25 | 1" |
| 05071002001 | 1,2 | 6,5 | 25 | 1" |

800/1 BTZ bits



Application: Slotted screws

Drive: 1/4" hexagon, suitable for DIN ISO 1173-D 6,3 bit holders

Design: BiTorsion for long service life, extra-tough, for universal use. Take it easy toolfinder: Output colour coding (yellow = slotted) and large stamp to enable the desired bit to be easily located.

| | mm | mm | mm | " |
|-------------|-----|-----|----|----|
| 05056064001 | 0,8 | 5,5 | 25 | 1" |
| 05056066001 | 1,0 | 5,5 | 25 | 1" |
| 05056068001 | 1,2 | 6,5 | 25 | 1" |

800/1 BDC bits



Application: Slotted screws

Drive: 1/4" hexagon, suitable for DIN ISO 1173-D 6,3 bit holders

Design: BiTorsion for long service life, diamond-coated for secure screw fit. Take it easy toolfinder: Output colour coding (yellow = slotted) and large stamp to enable the desired bit to be easily located.

| | mm | mm | mm | " |
|-------------|-----|-----|----|----|
| 05056172001 | 0,8 | 5,5 | 25 | 1" |
| 05056174001 | 1,0 | 5,5 | 25 | 1" |
| 05056176001 | 1,2 | 6,5 | 25 | 1" |

800/1 TZ bits



Application: Slotted screws

Drive: 1/4" hexagon, suitable for DIN ISO 1173-D 6,3 bit holders

Design: Torsion-style design to reduce premature wear, tough, for universal use

| | mm | mm | mm | " | mm |
|-------------|-----|-----|----|----|-----|
| 05056203001 | 0,5 | 4,0 | 25 | 1" | 4,0 |
| 05056210001 | 0,6 | 4,5 | 25 | 1" | 4,5 |
| 05056220001 | 0,8 | 5,5 | 25 | 1" | 5,5 |
| 05056225001 | 1,0 | 5,5 | 25 | 1" | 5,5 |
| 05056233001 | 1,2 | 6,5 | 25 | 1" | 6,2 |
| 05056240001 | 1,6 | 8,0 | 25 | 1" | 8,0 |

800/1 Z bits



Application: Slotted screws

Drive: 1/4" hexagon, suitable for DIN ISO 1173-D 6,3 bit holders

Design: Tough, for universal use

| | √ mm | √ mm | √ mm | √ mm | ∅ mm |
|-------------|---------|---------|---------|----------|---------|
| 05056200001 | 0,5 | 3,0 | 25 | 1" | 3,0 |
| 05056005001 | 0,5 | 3,0 | 39 | 1 17/32" | 3,0 |
| 05072050001 | 0,5 | 4,0 | 25 | 1" | 4,0 |
| 05056007001 | 0,5 | 4,0 | 39 | 1 17/32" | 4,0 |
| 05056010001 | 0,6 | 3,5 | 39 | 1 17/32" | 3,5 |
| 05072055001 | 0,6 | 4,5 | 25 | 1" | 4,5 |
| 05056015001 | 0,6 | 4,5 | 39 | 1 17/32" | 4,5 |
| 05072057001 | 0,8 | 5,5 | 25 | 1" | 5,5 |
| 05056020001 | 0,8 | 4,0 | 39 | 1 17/32" | 4,0 |
| 05056025001 | 0,8 | 5,5 | 39 | 1 17/32" | 5,5 |
| 05072059001 | 1,0 | 5,5 | 25 | 1" | 5,5 |
| 05056030001 | 1,0 | 5,5 | 39 | 1 17/32" | 5,5 |
| 05072061001 | 1,2 | 6,5 | 25 | 1" | 6,2 |
| 05072063001 | 1,2 | 8,0 | 25 | 1" | 8,0 |
| 05056037001 | 1,2 | 6,5 | 39 | 1 17/32" | 6,5 |
| 05056040001 | 1,2 | 8,0 | 39 | 1 17/32" | 8,0 |
| 05072065001 | 1,6 | 8,0 | 25 | 1" | 8,0 |
| 05056045001 | 1,6 | 8,0 | 39 | 1 17/32" | 8,0 |

800/1 Z Set SB

| | | 4013288 |
|-------------|--|---------|
| 05073300001 | 1 x 0.6x4.5x25; 1 x 0.8x5.5x25 | 029010 |
| 05073301001 | 1 x 1.0x5.5x25; 1 x 1.2x6.5x25 | 029027 |
| 05073302001 | 1 x 0.6x4.5x25; 1 x 1.0x5.5x25; 1 x 1.2x6.5x25 | 029034 |



800/1 Z Set D

| | | 4013288 |
|-------------|----------------|---------|
| 05073303001 | 1 x 1.0x5.5x25 | 029041 |
| | 1 x PH 2x25 | |
| | 1 x PZ 2x25 | |



Tip



Stainless Steel Bits

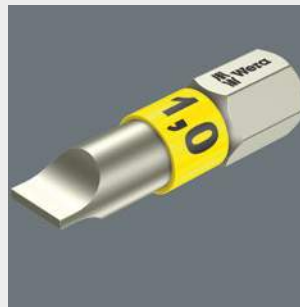

Wera stainless steel bits are manufactured out of stainless steel so unsightly rust can be avoided. The stainless steel bits from Wera are vacuum ice-hardened and have the hardness and strength needed for screw connections. There are no limitations to the industrial applications they are suitable for.



BDC-Bits



BDC-Bits are absolutely premium products. They have a softer BiTorsion zone which reduces the hardness of the shaft by about 20 % in comparison to the drive tip. This means that the peak loads that cause bit breakage and premature wear are absorbed in this zone – something which enhances the service life of the bits.

The diamond coating lowers the danger of slipping as the minute diamond particles literally "bite" themselves into the screw head. B stands for BiTorsion. DC stands for diamond coated.



"Take it easy"

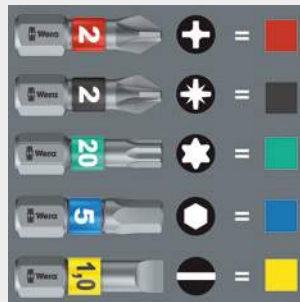

"Take it easy" tool finder with colour coding according to profiles and size stamp – for simple and rapid accessing of the required tool.



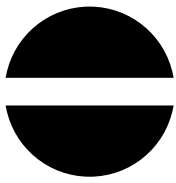

Bits for Slotted Screws



1/4" hexagon drive, suitable for F 6,3 bit holders (series 4)

3800/4 Bits for slotted screws, stainless



Application: Slotted screws

Drive: 1/4" hexagon, suitable for DIN ISO 1173-F 6,3 bit holders

Design: Stainless steel for minimising rust

| | ┘ mm | ┘ mm | ┘ mm | ┘ mm |
|-------------|---------|---------|---------|---------|
| 05071080001 | 1,0 | 5,5 | 89 | 3 1/2" |

800/4 Z bits



Application: Slotted screws

Drive: 1/4" hexagon, suitable for DIN ISO 1173-F 6,3 bit holders

Design: Tough, for universal use

| | ┘ mm | ┘ mm | ┘ mm | ┘ " | ∅ mm |
|-------------|---------|---------|---------|--------|---------|
| 05059305001 | 0,5 | 3,0 | 50 | 2" | 3,0 |
| 05059466001 | 0,5 | 3,0 | 70 | 2 3/4" | 3,0 |
| 05059307001 | 0,5 | 4,0 | 50 | 2" | 4,0 |
| 05059310001 | 0,6 | 3,5 | 50 | 2" | 3,5 |
| 05059472001 | 0,6 | 3,5 | 70 | 2 3/4" | 3,5 |
| 05059450001 | 0,6 | 3,5 | 152 | 6" | 3,5 |
| 05059315001 | 0,6 | 4,5 | 50 | 2" | 4,5 |
| 05059489001 | 0,6 | 4,5 | 89 | 3 1/2" | 4,5 |
| 05059320001 | 0,8 | 4,0 | 50 | 2" | 4,0 |
| 05059478001 | 0,8 | 4,0 | 70 | 2 3/4" | 4,0 |
| 05059480001 | 0,8 | 4,0 | 89 | 3 1/2" | 4,0 |
| 05059451001 | 0,8 | 4,0 | 152 | 6" | 4,0 |
| 05059325001 | 0,8 | 5,5 | 50 | 2" | 5,5 |
| 05059330001 | 1,0 | 5,5 | 50 | 2" | 5,5 |
| 05059486001 | 1,0 | 5,5 | 70 | 2 3/4" | 5,5 |
| 05059488001 | 1,0 | 5,5 | 89 | 3 1/2" | 5,5 |
| 05059452001 | 1,0 | 5,5 | 152 | 6" | 5,5 |
| 05059335001 | 1,0 | 6,0 | 50 | 2" | 6,0 |
| 05059337001 | 1,2 | 6,5 | 50 | 2" | 6,2 |
| 05059492001 | 1,2 | 6,5 | 70 | 2 3/4" | 6,2 |
| 05059490001 | 1,2 | 6,5 | 89 | 3 1/2" | 6,2 |
| 05059453001 | 1,2 | 6,5 | 152 | 6" | 6,2 |
| 05059340001 | 1,2 | 8,0 | 50 | 2" | 8,0 |
| 05059496001 | 1,2 | 8,0 | 89 | 3 1/2" | 8,0 |
| 05059345001 | 1,6 | 8,0 | 50 | 2" | 8,0 |
| 05059500001 | 1,6 | 8,0 | 89 | 3 1/2" | 8,0 |



5/16" hexagon drive, suitable for D 8 bit holders or direct drive (series 2)

800/2 Z bits



Application: Slotted screws

Drive: 5/16" hexagon, suitable for DIN ISO 1173-D 8 bit holders

Design: Tough, for universal use

| | mm | mm | mm | " | mm |
|-------------|-----|------|----|----------|------|
| 05057210001 | 0,8 | 5,5 | 41 | 1 19/32" | 5,5 |
| 05057213001 | 1,0 | 5,5 | 41 | 1 19/32" | 5,5 |
| 05057223001 | 1,2 | 6,5 | 41 | 1 19/32" | 6,5 |
| 05057225001 | 1,2 | 8,0 | 41 | 1 19/32" | 7,8 |
| 05057230001 | 1,6 | 8,0 | 41 | 1 19/32" | 7,8 |
| 05057235001 | 1,6 | 10,0 | 41 | 1 19/32" | 7,8 |
| 05057240001 | 2,0 | 12,0 | 41 | 1 19/32" | 12,0 |
| 05057250001 | 2,5 | 14,0 | 41 | 1 19/32" | 14,0 |
| 05057255001 | 2,5 | 16,0 | 41 | 1 19/32" | 16,0 |



4 mm 4 mm Halfmoon direct drive (series 9)

800/9 C bits



Application: Slotted screws

Drive: Halfmoon, 4 mm

Design: Hard

| | mm | mm | mm | " | mm |
|-------------|------|-----|----|----------|-----|
| 05135265001 | 0,23 | 1,5 | 44 | 1 47/64" | 1,5 |
| 05135264001 | 0,35 | 2,5 | 44 | 1 47/64" | 2,5 |
| 05135266001 | 0,40 | 2,0 | 44 | 1 47/64" | 2,0 |
| 05135267001 | 0,50 | 3,0 | 44 | 1 47/64" | 3,0 |

Guide Sleeves

807/4 Z bits



Application: Slotted screws with integrated guide sleeve

Drive: 1/4" hexagon, suitable for DIN ISO 1173-F 6,3 bit holders

Design: Tough, for universal use

| | mm | mm | mm | " | mm |
|-------------|-----|-----|----|--------|----|
| 05059503001 | 0,8 | 4,0 | 90 | 3 1/2" | 10 |
| 05059507001 | 1,0 | 5,5 | 90 | 3 1/2" | 11 |
| 05059515001 | 1,2 | 8,0 | 90 | 3 1/2" | 13 |
| 05059517001 | 1,6 | 8,0 | 90 | 3 1/2" | 13 |



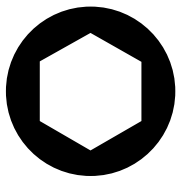

Bits for Hexagon Socket Screws



1/4" hexagon drive, suitable for D 6,3 bit holders (series 1)

840/1 IMP DC Impaktor bits



Application: Hexagon socket screws

Drive: 1/4" hexagon, suitable for DIN ISO 1173-D 6,3 bit holders

Design: The Impaktor technology ensures an above-average service life even under extreme conditions thanks to a best-possible utilisation of the material properties and optimally designed geometry, particularly suitable for use with conventional impact drivers, the rough diamond coating reduces the danger of any slipping out of the screw head due to the enhanced frictional resistance. Take it easy toolfinder: Output colour coding (blue = hexagon) and large stamp to enable the desired bit to be easily located.

| | mm | mm | " |
|-------------|-----|----|----|
| 05057603001 | 3,0 | 25 | 1" |
| 05057604001 | 4,0 | 25 | 1" |
| 05057605001 | 5,0 | 25 | 1" |
| 05057606001 | 6,0 | 25 | 1" |

840/1 IMP DC Impaktor bits SB

| | | 4013288 |
|-------------|------------|---------|
| 05073904001 | 1 x 4.0x25 | 158338 |
| 05073905001 | 1 x 5.0x25 | 158345 |
| 05073906001 | 1 x 6.0x25 | 158352 |



3840/1 TS bits, stainless



Application: Hexagon socket screws

Drive: 1/4" hexagon, suitable for DIN ISO 1173-D 6,3 bit holders

Design: Hex-Plus, stainless steel for minimising rust, special torsion-style design to reduce premature wear. Take it easy toolfinder: Output colour coding (blue = hexagon) and large stamp to enable the desired bit to be easily located.

| | mm | mm | " |
|-------------|-----|-------|-------|
| 05071070001 | 1,5 | 25 | 1" |
| 05071071001 | 2,0 | 25 | 1" |
| 05071072001 | 2,5 | 25 | 1" |
| 05071073001 | 3,0 | 25 | 1" |
| 05071074001 | 4,0 | 25 | 1" |
| 05071075001 | 5,0 | 25 | 1" |
| 05071077001 | 5,5 | 25 | 1" |
| 05071076001 | 6,0 | 25 | 1" |
| 05071060001 | | 3/32" | 25 1" |
| 05071061001 | | 7/64" | 25 1" |
| 05071062001 | | 1/8" | 25 1" |
| 05071063001 | | 9/64" | 25 1" |
| 05071064001 | | 5/32" | 25 1" |
| 05071065001 | | 3/16" | 25 1" |
| 05071066001 | | 1/4" | 25 1" |

840/1 BTZ bits



Application: Hexagon socket screws

Drive: 1/4" hexagon, suitable for DIN ISO 1173-D 6,3 bit holders

Design: Hex-Plus, BiTorsion for long service life, extra-tough, for universal use. Take it easy toolfinder: Output colour coding (blue = hexagon) and large stamp to enable the desired bit to be easily located.

| | mm | mm | " |
|-------------|-----|----|----|
| 05056680001 | 1,5 | 25 | 1" |
| 05056681001 | 2,0 | 25 | 1" |
| 05056682001 | 2,5 | 25 | 1" |
| 05056683001 | 3,0 | 25 | 1" |
| 05056684001 | 4,0 | 25 | 1" |
| 05056685001 | 5,0 | 25 | 1" |
| 05056686001 | 5,5 | 25 | 1" |
| 05056687001 | 6,0 | 25 | 1" |





840/1 Z bits





Application: Hexagon socket screws

Drive: 1/4" hexagon, suitable for DIN ISO 1173-D 6,3 bit holders

Design: Hex-Plus, tough, for universal use

| |  mm |  mm |  mm |  mm |
|-------------|---|---|---|---|
| 05056303001 | 1,5 | 25 | 1" | |
| 05056305001 | 2,0 | 25 | 1" | |
| 05056310001 | 2,5 | 25 | 1" | |
| 05056315001 | 3,0 | 25 | 1" | |
| 05056320001 | 4,0 | 25 | 1" | |
| 05056325001 | 5,0 | 25 | 1" | |
| 05056330001 | 6,0 | 25 | 1" | |
| 05056332001 | 7,0 | 25 | 1" | |
| 05056335001 | 8,0 | 25 | 1" | |
| 05056340001 | 10,0 | 25 | 1" | |
| 05135060001 | | 0,05" | 25 | 1" |
| 05135070001 | | 1/16" | 25 | 1" |
| 05135071001 | | 5/64" | 25 | 1" |
| 05135072001 | | 3/32" | 25 | 1" |
| 05135078001 | | 7/64" | 25 | 1" |
| 05135073001 | | 1/8" | 25 | 1" |
| 05135069001 | | 9/64" | 25 | 1" |
| 05135074001 | | 5/32" | 25 | 1" |
| 05135075001 | | 3/16" | 25 | 1" |
| 05135079001 | | 7/32" | 25 | 1" |
| 05135076001 | | 1/4" | 25 | 1" |
| 05135077001 | | 5/16" | 25 | 1" |
| 05135068001 | | 3/8" | 25 | 1" |

840/1 Z Set SB

| |  | |  4013288 |
|-------------|---|---------------------------------------|--|
| 05073342001 | ○ | 1 x 2.0x25; 1 x 2.5x25; 1 x 3.0x25 | 029607 |
| 05073344001 | ○ | 1 x 4.0x25; 1 x 5.0x25; 1 x 6.0x25 | 029614 |







842/1 Z bits



Application: Hexagon socket screws

Drive: 1/4" hexagon, suitable for DIN ISO 1173-D 6,3 bit holders

Design: Ball end, tough, for universal use

| |  mm |  mm |  mm |  mm |
|-------------|---|---|---|---|
| 05056350001 | 2,5 | 25 | 1" | |
| 05056352001 | 3,0 | 25 | 1" | |
| 05056354001 | 4,0 | 25 | 1" | |
| 05056356001 | 5,0 | 25 | 1" | |
| 05056358001 | 6,0 | 25 | 1" | |
| 05380103001 | | 3/32" | 25 | 1" |
| 05380104001 | | 7/64" | 25 | 1" |
| 05380105001 | | 1/8" | 25 | 1" |
| 05380106001 | | 9/64" | 25 | 1" |
| 05380107001 | | 5/32" | 25 | 1" |
| 05380108001 | | 3/16" | 25 | 1" |
| 05380109001 | | 7/32" | 25 | 1" |
| 05380110001 | | 1/4" | 25 | 1" |



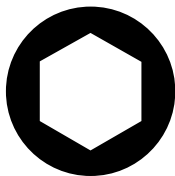

Bits for Hexagon Socket Screws



1/4" hexagon drive, suitable for F 6,3 bit holders (series 4)

840/4 IMP DC Impaktor bits



Application: Hexagon socket screws

Drive: 1/4" hexagon, suitable for DIN ISO 1173-F 6,3 bit holders

Design: The Impaktor technology ensures an above-average service life even under extreme conditions thanks to a best-possible utilisation of the material properties and optimally designed geometry, particularly suitable for use with conventional impact drivers, the rough diamond coating reduces the danger of any slipping out of the screw head due to the enhanced frictional resistance. Take it easy toolfinder: Output colour coding (blue = hexagon) and large stamp to enable the desired bit to be easily located.

| | mm | mm | " |
|-------------|-----|----|----|
| 05057644001 | 4,0 | 50 | 2" |
| 05057645001 | 5,0 | 50 | 2" |
| 05057646001 | 6,0 | 50 | 2" |

3840/4 Bits, stainless



Application: Hexagon socket screws

Drive: 1/4" hexagon, suitable for DIN ISO 1173-F 6,3 bit holders

Design: Stainless steel for minimising rust

| | mm | mm | " |
|-------------|-----|-------|-----------|
| 05071101001 | 3,0 | 89 | 3 1/2" |
| 05071102001 | 4,0 | 89 | 3 1/2" |
| 05071103001 | 5,0 | 89 | 3 1/2" |
| 05071049001 | 5,5 | 50 | 2" |
| 05071104001 | 6,0 | 89 | 3 1/2" |
| 05071105001 | | 3/32" | 89 3 1/2" |
| 05071106001 | | 1/8" | 89 3 1/2" |
| 05071107001 | | 5/32" | 89 3 1/2" |
| 05071108001 | | 3/16" | 89 3 1/2" |

840/4 IMP DC Impaktor bits SB

| | | 4013288 |
|-------------|------------|---------|
| 05073944001 | 1 x 4.0x50 | 158451 |
| 05073945001 | 1 x 5.0x50 | 158468 |
| 05073946001 | 1 x 6.0x50 | 158475 |



840/4 Z bits



Application: Hexagon socket screws

Drive: 1/4" hexagon, suitable for DIN ISO 1173-F 6,3 bit holders

Design: Hex-Plus, tough, for universal use

| | ⊙ mm | ⊙ mm | ⊏ mm | ⊏ mm | ∅ mm |
|-------------|---------|---------|---------|---------|---------|
| 05160885001 | 0,9 | | 50 | 2" | 2,6 |
| 05059602001 | 1,5 | | 50 | 2" | 2,0 |
| 05059603001 | 2,0 | | 50 | 2" | 4,0 |
| 05059628001 | 2,0 | | 89 | 3 1/2" | 4,0 |
| 05059604001 | 2,5 | | 50 | 2" | 4,0 |
| 05059629001 | 2,5 | | 89 | 3 1/2" | 4,0 |
| 05059605001 | 3,0 | | 50 | 2" | 4,0 |
| 05059630001 | 3,0 | | 89 | 3 1/2" | 4,0 |
| 05380033001 | 3,0 | | 152 | 6" | 4,0 |
| 05059610001 | 4,0 | | 50 | 2" | 5,0 |
| 05059631001 | 4,0 | | 89 | 3 1/2" | 5,0 |
| 05059634001 | 4,0 | | 152 | 6" | 5,0 |
| 05059615001 | 5,0 | | 50 | 2" | 6,0 |
| 05059632001 | 5,0 | | 89 | 3 1/2" | 6,0 |
| 05059635001 | 5,0 | | 152 | 6" | 6,0 |
| 05059620001 | 6,0 | | 50 | 2" | 5,0 |
| 05059633001 | 6,0 | | 89 | 3 1/2" | - |
| 05059636001 | 6,0 | | 152 | 6" | - |
| 05059625001 | 8,0 | | 50 | 2" | - |
| 05350430001 | | 0,05" | 50 | 2" | 2,5 |
| 05135090001 | | 1/16" | 50 | 2" | 2,5 |
| 05380045001 | | 1/8" | 152 | 6" | 4,0 |
| 05135091001 | | 5/64" | 50 | 2" | 3,0 |
| 05059660001 | | 5/64" | 89 | 3 1/2" | 3,0 |
| 05135092001 | | 3/32" | 50 | 2" | 3,0 |
| 05059661001 | | 3/32" | 89 | 3 1/2" | 3,5 |
| 05135093001 | | 7/64" | 50 | 2" | 3,5 |
| 05059662001 | | 7/64" | 89 | 3 1/2" | 4,0 |
| 05135094001 | | 1/8" | 50 | 2" | 4,0 |
| 05059663001 | | 1/8" | 89 | 3 1/2" | 4,0 |
| 05135095001 | | 9/64" | 50 | 2" | 4,5 |
| 05059664001 | | 9/64" | 89 | 3 1/2" | 4,5 |
| 05380046001 | | 9/64" | 152 | 6" | 4,5 |
| 05135096001 | | 5/32" | 50 | 2" | 5,0 |
| 05059665001 | | 5/32" | 89 | 3 1/2" | 5,0 |
| 05380047001 | | 5/32" | 152 | 6" | 5,0 |
| 05135097001 | | 3/16" | 50 | 2" | 6,0 |
| 05059666001 | | 3/16" | 89 | 3 1/2" | 6,0 |
| 05380048001 | | 3/16" | 152 | 6" | 6,0 |
| 05135098001 | | 7/32" | 50 | 2" | - |
| 05059667001 | | 7/32" | 89 | 3 1/2" | - |
| 05380049001 | | 7/32" | 152 | 6" | - |
| 05135099001 | | 1/4" | 50 | 2" | - |
| 05059668001 | | 1/4" | 89 | 3 1/2" | - |
| 05380050001 | | 1/4" | 152 | 6" | - |
| 05346288001 | | 5/16" | 50 | 2" | - |

Tip



Impaktor-Bits



Impact-Bits are needed when a strong power tool (e.g. 18 volt impact screwdriver) is used. Impact bits were specifically developed to withstand high power tool forces.



Hex-Plus



Hexagon screws can endure a problem because the contact surfaces delivering the power from the conventional tool, is transferred to the screw via very small surface areas. The consequence: the screw can become damaged (rounding out). Hex-Plus tools have a greater contact surface that prevents this from happening! Good to know: Hex-Plus tools fit into every standard hexagon socket screw!



"Take it easy"

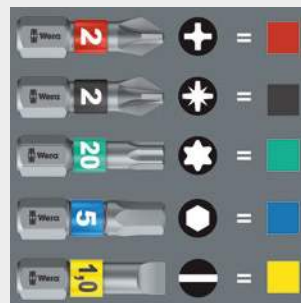

"Take it easy" tool finder with colour coding according to profiles and size stamp – for simple and rapid accessing of the required tool.



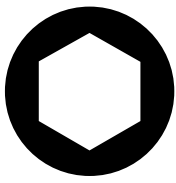

Bits for Hexagon Socket Screws



1/4" hexagon drive, suitable for F 6,3 bit holders (series 4)





842/4 Bits



Application: Hexagon socket screws

Drive: 1/4" hexagon, suitable for DIN ISO 1173-F 6,3 bit holders

Design: Ball end, tough, for universal use

| |  mm |  mm |  mm |  mm |
|-------------|---|---|---|---|
| 05059680001 | 3,0 | | 89 | 3 1/2" |
| 05059681001 | 4,0 | | 89 | 3 1/2" |
| 05059682001 | 5,0 | | 89 | 3 1/2" |
| 05059683001 | 6,0 | | 89 | 3 1/2" |
| 05380124001 | | 3/32" | 89 | 3 1/2" |
| 05380125001 | | 7/64" | 89 | 3 1/2" |
| 05380126001 | | 1/8" | 89 | 3 1/2" |
| 05380127001 | | 9/64" | 89 | 3 1/2" |
| 05380128001 | | 5/32" | 89 | 3 1/2" |
| 05380129001 | | 3/16" | 89 | 3 1/2" |
| 05380130001 | | 7/32" | 89 | 3 1/2" |
| 05380131001 | | 1/4" | 89 | 3 1/2" |



$\frac{5}{16}$ " hexagon drive, suitable for D 8 bit holders or direct drive (series 2)

840/2 Z Bits



Application: Hexagon socket screws

Drive: $\frac{5}{16}$ " hexagon, suitable for DIN ISO 1173-D 8 bit holders

Design: Hex-Plus, tough, for universal use

| | ⊙ mm | ⊙ mm | □, mm | □, " |
|-------------|------------------|---------|----------|---------|
| 05057505001 | 3 | 30 | 1 3/16" | |
| 05057510001 | 4 | 30 | 1 3/16" | |
| 05057550001 | 4 | 50 | 2" | |
| 05057560001 | 4 | 70 | 2" | |
| 05057570001 | 4 | 100 | 4" | |
| 05057515001 | 5 | 30 | 1 3/16" | |
| 05057551001 | 5 | 50 | 2" | |
| 05057561001 | 5 | 70 | 2 3/4" | |
| 05057571001 | 5 | 100 | 4" | |
| 05057520001 | 6 | 30 | 1 3/16" | |
| 05057552001 | 6 | 50 | 2" | |
| 05057562001 | 6 | 70 | 2 3/4" | |
| 05057572001 | 6 | 100 | 4" | |
| 05057553001 | 7 | 50 | 2" | |
| 05057573001 | 7 | 100 | 4" | |
| 05057525001 | 8 | 30 | 1 3/16" | |
| 05057554001 | 8 | 50 | 2" | |
| 05057563001 | 8 | 70 | 2 3/4" | |
| 05057574001 | 8 | 100 | 4" | |
| 05057530001 | 10 | 30 | 1 3/16" | |
| 05057555001 | 10 | 50 | 2" | |
| 05057575001 | 10 | 100 | 4" | |
| 05221102001 | $\frac{5}{32}$ " | 30 | 1 3/16" | |
| 05057565001 | $\frac{5}{32}$ " | 70 | 2 3/4" | |
| 05135083001 | $\frac{3}{16}$ " | 30 | 1 3/16" | |
| 05135084001 | $\frac{7}{32}$ " | 30 | 1 3/16" | |
| 05057566001 | $\frac{7}{32}$ " | 70 | 2 3/4" | |
| 05135080001 | $\frac{1}{4}$ " | 30 | 1 3/16" | |
| 05057567001 | $\frac{1}{4}$ " | 70 | 2 3/4" | |
| 05135081001 | $\frac{5}{16}$ " | 30 | 1 3/16" | |
| 05057568001 | $\frac{5}{16}$ " | 70 | 2 3/4" | |
| 05135082001 | $\frac{3}{8}$ " | 30 | 1 3/16" | |

Tip



Hexagon ball tip



The spherical drive profile means that it is possible to swivel the axis of the tool to that of the screw, and therefore enable angled, "around-the-corner" screw-driving jobs.



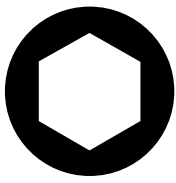

Bits for Hexagon Socket Screws



4 mm 4 mm Halfmoon direct drive (series 9)

840/9 C bits Hex-Plus



Application: Hexagon socket screws

Drive: Halfmoon, 4 mm

Design: Hard

| | mm | mm | mm | mm |
|-------------|-----|----|-----------------------------------|-----|
| 05135268001 | 1,5 | 44 | 1 ⁴⁷ / ₆₄ " | 2,6 |
| 05135269001 | 2,0 | 44 | 1 ⁴⁷ / ₆₄ " | 2,6 |

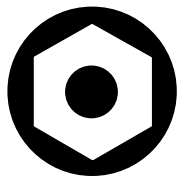

Bits for Tamper-Proof Hexagon Socket Screws with safety pin



1/4" hexagon drive, suitable for D 6,3 bit holders (series 1)

840/1 Z Tamper-proof Hex-Plus BO bits



Application: Hexagon socket screws with safety pin (BO = with bore hole)

Drive: 1/4" hexagon, suitable for DIN ISO 1173-D 6,3 bit holders

Design: Hex-Plus with bore hole, tough, for universal use

| | ⊙ mm | ┆ mm | ┆ " |
|-------------|---------|---------|--------|
| 05056341001 | 2,0 | 25 | 1" |
| 05056342001 | 2,5 | 25 | 1" |
| 05056343001 | 3,0 | 25 | 1" |
| 05056344001 | 4,0 | 25 | 1" |
| 05056345001 | 5,0 | 25 | 1" |
| 05056346001 | 6,0 | 25 | 1" |



1/4" hexagon drive, suitable for F 6,3 bit holders (series 4)

840/4 Z Tamper-proof Hex-Plus BO bits



Application: Hexagon socket screws with safety pin (BO = with bore hole)

Drive: 1/4" hexagon, suitable for DIN ISO 1173-F 6,3 bit holders

Design: Hex-Plus with bore hole, tough, for universal use

| | ⊙ mm | ┆ mm | ┆ " | ∅ mm |
|-------------|---------|---------|--------|---------|
| 05059640001 | 2,0 | 89 | 3 1/2" | 4,0 |
| 05059641001 | 2,5 | 89 | 3 1/2" | 4,0 |
| 05059642001 | 3,0 | 89 | 3 1/2" | 4,0 |
| 05059643001 | 4,0 | 89 | 3 1/2" | 5,0 |
| 05059644001 | 5,0 | 89 | 3 1/2" | 6,0 |
| 05059645001 | 6,0 | 89 | 3 1/2" | - |



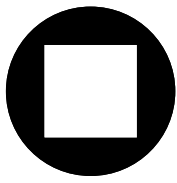

Bits for Square Socket Screws

1/4" hexagon drive, suitable for D 6,3 bit holders (series 1)

868/1 IMP DC Impaktor Square-Plus bits



Application: Square socket head screws

Drive: 1/4" hexagon, suitable for DIN ISO 1173-D 6,3 bit holders

Design: The Impaktor technology ensures an above-average service life even under extreme conditions thanks to a best-possible utilisation of the material properties and optimally designed geometry, particularly suitable for use with conventional impact drivers, the rough diamond coating reduces the danger of any slipping out of the screw head due to the enhanced frictional resistance

| | | mm | |
|-------------|-----|----|----|
| 05057631001 | # 2 | 25 | 1" |
| 05057632001 | # 3 | 25 | 1" |

868/1 IMP DC SB Impaktor Square-Plus bits

| 05073931001 | 1 x # 2x25 | 158437 |
|-------------|------------|--------|
| 05073932001 | 1 x # 3x25 | 158444 |

4013288



3868/1 TS Square-Plus bits, stainless



Application: Square socket head screws

Drive: 1/4" hexagon, suitable for DIN ISO 1173-D 6,3 bit holders

Design: Stainless steel for minimising rust, special torsion-style design to reduce premature wear

| | | mm | |
|-------------|-----|----|----|
| 05071025001 | # 2 | 25 | 1" |

868/1 BTZ Square-Plus bits



Application: Square socket head screws

Drive: 1/4" hexagon, suitable for DIN ISO 1173-D 6,3 bit holders

Design: BiTorsion for long service life, extra-tough, for universal use

| | | mm | | mm |
|-------------|-----|----|----|-----|
| 05066445001 | # 1 | 25 | 1" | 4,2 |
| 05066446001 | # 2 | 25 | 1" | 4,2 |
| 05066447001 | # 3 | 25 | 1" | 5,5 |





868/1 Z Square-Plus bits



Application: Square socket head screws

Drive: 1/4" hexagon, suitable for DIN ISO 1173-D 6,3 bit holders

Design: Tough, for universal use

| |  |  mm |  " |  mm |
|-------------|---|---|--|---|
| 05066395001 | # 00 | 25 | 1" | 3,5 |
| 05066400001 | # 0 | 25 | 1" | 3,5 |
| 05066405001 | # 1 | 25 | 1" | 4,5 |
| 05066410001 | # 2 | 25 | 1" | 6,0 |
| 05066415001 | # 3 | 25 | 1" | 6,0 |
| 05066420001 | # 4 | 25 | 1" | 8,0 |





868/1 V Square-Plus bits





Application: Square socket head screws

Drive: 1/4" hexagon, suitable for DIN ISO 1173-D 6,3 bit holders

Design: Tough, for universal use, with holding function

| |  |  mm |  " |  mm |
|-------------|---|---|--|---|
| 05340245001 | # 1 | 25 | 1" | 6,1 |
| 05066394001 | # 2 | 25 | 1" | 6,1 |
| 05066396001 | # 3 | 25 | 1" | 6,1 |

Bit-Box 20 V Robertson

| | |
|---|--|
|  |  4013288 188083 |
| 05057790001 |  868/1 V 20 x # 2x25 |



Tip



Impaktor-Bits



For an above-average service life. Maximum utilisation of the material properties, a very special geometry – designed particularly to meet the extreme demands – as well as a specific manufacturing process mean that Wera Impaktor tools have an above-average service life. Another product advantage is the coating of the Impaktor bits with minute diamond particles. These diamond particles reduce the cam-out effects – particularly high in power tool applications – which can lead to a slipping out of the screw head. The diamond particles literally bite themselves into the screw recess. This means that less contact pressure is required, something that greatly delays fatigue setting-in in power tool screwdriving jobs.

V bits:

Holding function for Robertson screws

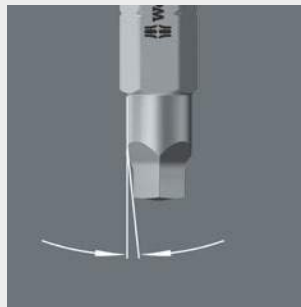

V bits have a conical profile. The clamping forces thus resulting hold Robertson screws securely on the tip of the tool. Ideal for screwdriving at difficult-to-access places.

Bit-Box



The slide switch allows a simple and gradual removal and reinsertion of the bits. The transparent reverse side means that it is easy to know how many bits are still in the box.



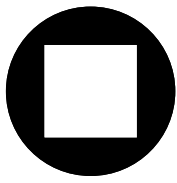

Bits for Square Socket Screws

 1/4" hexagon drive, suitable for F 6,3 bit holders (series 4)



868/4 IMP DC Impaktor Square-Plus bits







Application: Square socket head screws

Drive: 1/4" hexagon, suitable for DIN ISO 1173-F 6,3 bit holders

Design: The Impaktor technology ensures an above-average service life even under extreme conditions thanks to a best-possible utilisation of the material properties and optimally designed geometry, particularly suitable for use with conventional impact drivers, the rough diamond coating reduces the danger of any slipping out of the screw head due to the enhanced frictional resistance

| |  |  mm |  " |
|-------------|--|--|---|
| 05057671001 | # 2 | 50 | 2" |
| 05057672001 | # 3 | 50 | 2" |

868/4 IMP DC SB Impaktor Square-Plus bits

| |  | |  |
|-------------|---|------------|---|
| 05073971001 |  | 1 x # 2x50 | 158550 |
| 05073972001 |  | 1 x # 3x50 | 158567 |







3868/4 Square-Plus bits, stainless



Application: Square socket screws

Drive: 1/4" hexagon, suitable for DIN ISO 1173-F 6,3 bit holders

Design: Stainless steel for minimising rust

| |  |  mm |  " |  mm |
|-------------|---|---|--|---|
| 05071097001 | # 1 | 89 | 3 1/2" | 4,5 |
| 05071098001 | # 2 | 89 | 3 1/2" | 5,0 |
| 05071099001 | # 3 | 89 | 3 1/2" | 5,5 |





868/4 BTZ Square-Plus bits



Application: Square socket head screws

Drive: 1/4" hexagon, suitable for DIN ISO 1173-F 6,3 bit holders

Design: BiTorsion for long service life, extra-tough, for universal use

| |  |  mm |  " |  mm |
|-------------|---|---|--|---|
| 05060147001 | #1 | 50 | 2" | 4,2 |
| 05060148001 | #2 | 50 | 2" | 4,2 |
| 05060149001 | #3 | 50 | 2" | 5,5 |





868/4 Square-Plus bits



Application: Square socket head screws

Drive: 1/4" hexagon, suitable for DIN ISO 1173-F 6,3 bit holders

Design: Tough, for universal use

| |  |  mm |  " |  mm |
|-------------|---|---|--|---|
| 05060150001 | # 00 | 50 | 2" | 3,5 |
| 05060155001 | # 0 | 50 | 2" | 3,5 |
| 05060160001 | # 1 | 50 | 2" | 4,5 |
| 05060180001 | # 1 | 70 | 2 3/4" | 4,5 |
| 05134800001 | # 1 | 89 | 3 1/2" | 4,5 |
| 05134805001 | # 1 | 152 | 6" | 4,5 |
| 05060165001 | # 2 | 50 | 2" | 6,0 |
| 05060182001 | # 2 | 70 | 2 3/4" | 6,0 |
| 05134801001 | # 2 | 89 | 3 1/2" | 6,0 |
| 05134806001 | # 2 | 152 | 6" | 6,0 |
| 05060170001 | # 3 | 50 | 2" | 6,0 |
| 05060184001 | # 3 | 70 | 2 3/4" | 6,0 |
| 05134802001 | # 3 | 89 | 3 1/2" | 6,0 |
| 05134807001 | # 3 | 152 | 6" | 6,0 |
| 05060175001 | # 4 | 50 | 2" | 8,0 |





868/4 V Square-Plus bits



Application: Square socket head screws

Drive: 1/4" hexagon, suitable for DIN ISO 1173-F 6,3 bit holders

Design: Tough, for universal use, with holding function

| |  |  mm |  " |  mm |
|-------------|---|---|--|---|
| 05060300001 | # 1 | 50 | 2" | 4,5 |
| 05060297001 | # 1 | 89 | 3 1/2" | 4,5 |
| 05060301001 | # 2 | 50 | 2" | 6,0 |
| 05060302001 | # 2 | 70 | 2 3/4" | 6,0 |
| 05060303001 | # 2 | 89 | 3 1/2" | 6,0 |
| 05060304001 | # 2 | 152 | 6" | 6,0 |
| 05060296001 | # 3 | 50 | 2" | 6,0 |
| 05060298001 | # 3 | 89 | 3 1/2" | 6,0 |

Tip



BTZ-Bits

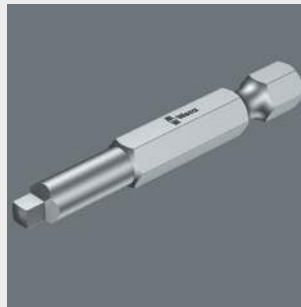

BTZ-Bits have an additional tempered BITorsion zone, which reduces the hardness of the shaft by about 20 % in comparison to the drive tip. This means that the peak loads that cause bit breakage and premature wear are absorbed in this zone – something which enhances the service life of the bits.



Stainless Steel Bits



Wera stainless steel bits are manufactured out of stainless steel so unsightly rust can be avoided. The stainless steel bits from Wera are vacuum ice-hardened and have the hardness and strength needed for screw connections. There are no limitations to the industrial applications they are suitable for.

V bits:

Holding function for Robertson screws

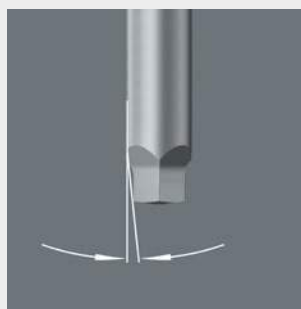

V bits have a conical profile. The clamping forces thus resulting hold Robertson screws securely on the tip of the tool. Ideal for screwdriving at difficult-to-access places.



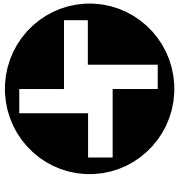

Bits for TORQ-SET® Screws



1/4" hexagon drive, suitable for D 6,3 bit holders (series 1)





871/1 DC TORQ-SET® Mplus bits



Application: TORQ-SET® screws

Drive: 1/4" hexagon, suitable for DIN ISO 1173-D 6,3 bit holders

Design: Mplus for higher breaking torque and longer service life, diamond-coated for secure screw fit

| |  mm |  mm |  mm |  mm |  mm |
|-------------|---|---|---|---|---|
| 05066638001 | 4 | 25 | 1" | 4,7 | |
| 05066640001 | 6 | 25 | 1" | 4,7 | |
| 05066642001 | 8 | 25 | 1" | 6,0 | |
| 05066644001 | 10 | 25 | 1" | 6,0 | |
| 05066646001 | 1/4" | 32 | 1 1/4" | 11,0 | |





871/1 TORQ-SET® Mplus bits, 32 mm



Application: TORQ-SET® screws

Drive: 1/4" hexagon, suitable for DIN ISO 1173-D 6,3 bit holders

Design: Mplus for higher breaking torque and longer service life, tough, for universal use

| |  mm |  mm |  mm |  mm |
|-------------|---|---|---|---|
| 05066634001 | 1/4" | 32 | 1 1/4" | 11,0 |
| 05066635001 | 5/16" | 32 | 1 1/4" | 11,0 |

871/1 TORQ-SET® Mplus bits, 25 mm



Application: TORQ-SET® screws

Drive: 1/4" hexagon, suitable for DIN ISO 1173-D 6,3 bit holders

Design: Mplus for higher breaking torque and longer service life, tough, for universal use

| |  mm |  mm |  mm |  mm |  mm |
|-------------|---|---|---|---|---|
| 05066618001 | 0 | 25 | 1" | 4,7 | |
| 05066619001 | 1 | 25 | 1" | 4,7 | |
| 05066620001 | 2 | 25 | 1" | 4,7 | |
| 05066622001 | 3 | 25 | 1" | 4,7 | |
| 05066624001 | 4 | 25 | 1" | 4,7 | |
| 05066626001 | 5 | 25 | 1" | 4,7 | |
| 05066628001 | 6 | 25 | 1" | 4,7 | |
| 05066630001 | 8 | 25 | 1" | 6,0 | |
| 05066632001 | 10 | 25 | 1" | 6,0 | |
| 05066633001 | 1/4" | 25 | 1" | 6,0 | |



1/4" hexagon drive, suitable for F 6,3 bit holders (series 4)





871/4 DC TORQ-SET® Mplus bits



Application: TORQ-SET® screws

Drive: 1/4" hexagon, suitable for DIN ISO 1173-F 6,3 bit holders

Design: Mplus for higher breaking torque and longer service life, diamond-coated for secure screw fit

| |  |  |  |  |
|-------------|---|---|---|---|
| | mm | mm | mm | " |
| 05324901001 | 2 | 50 | 2" | |
| 05066688001 | 4 | 50 | 2" | |
| 05066690001 | 6 | 50 | 2" | |
| 05066692001 | 8 | 50 | 2" | |
| 05066694001 | 10 | 50 | 2" | |
| 05066696001 | | 1/4" | 50 | 2" |
| 05344515001 | | 5/16" | 50 | 2" |





871/4 TORQ-SET® Mplus bits



Application: TORQ-SET® screws

Drive: 1/4" hexagon, suitable for DIN ISO 1173-F 6,3 bit holders

Design: Mplus for higher breaking torque and longer service life

| |  |  |  |  |
|-------------|---|---|---|---|
| | mm | mm | mm | " |
| 05066660001 | 2 | 50 | 2" | |
| 05066683001 | 2 | 89 | 3 1/2" | |
| 05066662001 | 3 | 50 | 2" | |
| 05066684001 | 3 | 89 | 3 1/2" | |
| 05066664001 | 4 | 50 | 2" | |
| 05066685001 | 4 | 89 | 3 1/2" | |
| 05066666001 | 5 | 50 | 2" | |
| 05066668001 | 6 | 50 | 2" | |
| 05066676001 | 6 | 70 | 2 3/4" | |
| 05066686001 | 6 | 89 | 3 1/2" | |
| 05066670001 | 8 | 50 | 2" | |
| 05066678001 | 8 | 70 | 2 3/4" | |
| 05066687001 | 8 | 89 | 3 1/2" | |
| 05066672001 | 10 | 50 | 2" | |
| 05066680001 | 10 | 70 | 2 3/4" | |
| 05066682001 | 10 | 89 | 3 1/2" | |
| 05066674001 | | 1/4" | 50 | 2" |
| 05221110001 | | 5/16" | 50 | 2" |

Tip

TORQ-SET® Mplus

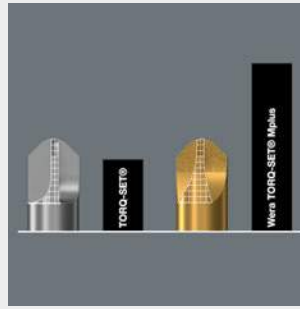

Wera developed the Mplus profile with stronger flanks compared with tools with a conventional TORQ-SET® profile. This results in approximately 70 % extra torsional strength and greatly extends the service life of Wera Mplus tools.



Bits with diamond coating



The diamond coating of the DC bits lowers the danger of slipping as the minute diamond particles literally "bite" themselves into the screw head.



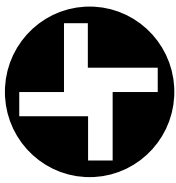

Bits for TORQ-SET® Screws



5/16" hexagon drive, suitable for D 8 bit holders or direct drive (series 2)





871/2 TORQ-SET® Mplus bits



Application: TORQ-SET® screws

Drive: 5/16" hexagon, suitable for DIN ISO 1173-D 8 bit holders

Design: Mplus for higher breaking torque and longer service life, tough, for universal use

| |  mm |  mm |  mm |  mm |
|-------------|--|--|--|--|
| 05066650001 | 8 | | 32 | 1 1/4" |
| 05066652001 | 10 | | 32 | 1 1/4" |
| 05066654001 | | 1/4" | 32 | 1 1/4" |
| 05066656001 | | 5/16" | 32 | 1 1/4" |
| 05066658001 | | 3/8" | 32 | 1 1/4" |



7/16" hexagon drive, suitable for F 11,2 bit holders or direct drive (series 7)





871/7 TORQ-SET® Mplus bits



Application: TORQ-SET® screws

Drive: 7/16" hexagon, suitable for power tools with DIN ISO 1173-F 11,2 chuck

Design: Mplus for higher breaking torque and longer service life

| |  mm |  mm |  mm |  mm |
|-------------|--|--|--|--|
| 05066740001 | 1/4" | 35 | 1 3/8" | 11,0 |
| 05066742001 | 5/16" | 35 | 1 3/8" | 11,0 |
| 05066744001 | 3/8" | 35 | 1 3/8" | 11,0 |
| 05066746001 | 7/16" | 35 | 1 3/8" | 11,0 |



5/16" hexagon drive, suitable for F 8 bit holders or direct drive (series 6)





871/6 TORQ-SET® Mplus bits



Application: TORQ-SET® screws

Drive: 5/16" hexagon, suitable for DIN ISO 1173-F 8 bit holders

Design: Mplus for higher breaking torque and longer service life

| |  mm |  mm |  mm |  mm |  mm |
|-------------|--|--|--|--|--|
| 05066700001 | 8 | | 35 | 1 3/8" | 6,0 |
| 05066702001 | 10 | | 35 | 1 3/8" | 6,0 |
| 05066704001 | | 1/4" | 35 | 1 3/8" | 11,0 |



5/8" direct drive hexagon (series 19)



871/19 TORQ-SET® Mplus bits



Application: TORQ-SET® screws

Drive: 5/8" hexagon

Design: Mplus for higher breaking torque and longer service life

| |  mm |  mm |  mm |
|-------------|--|--|--|
| 05066750001 | 1/2" | 40 | 1 9/16" |
| 05066752001 | 9/16" | 40 | 1 9/16" |
| 05066754001 | 5/8" | 40 | 1 9/16" |

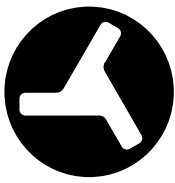

Bits for TRI-WING® Screws



1/4" hexagon drive, suitable for D 6,3 bit holders (series 1)

875/1 TRI-WING® bits, 25 mm



Application: TRI-WING® screws

Drive: 1/4" hexagon, suitable for DIN ISO 1173-D 6,3 bit holders

Design: Tough, for universal use

| |  | □, mm | □, " | ∅ mm |
|-------------|---|----------|---------|---------|
| 05066758001 | 0 | 25 | 1" | 4,7 |
| 05066760001 | 1 | 25 | 1" | 4,7 |
| 05066762001 | 2 | 25 | 1" | 4,7 |
| 05066764001 | 3 | 25 | 1" | 4,7 |
| 05066766001 | 4 | 25 | 1" | 6,2 |
| 05066768001 | 5 | 25 | 1" | 6,2 |

875/1 TRI-WING® bits, 32 mm



Application: TRI-WING® screws

Drive: 1/4" hexagon, suitable for DIN ISO 1173-D 6,3 bit holders

Design: Tough, for universal use

| |  | □, mm | □, " | ∅ mm |
|-------------|---|----------|---------|---------|
| 05066770001 | 6 | 32 | 1 1/4" | 11,0 |
| 05066772001 | 7 | 32 | 1 1/4" | 11,0 |
| 05066774001 | 8 | 32 | 1 1/4" | 12,5 |



1/4" hexagon drive, suitable for F 6,3 bit holders (series 4)

875/4 TRI-WING® bits



Application: TRI-WING® screws

Drive: 1/4" hexagon, suitable for DIN ISO 1173-F 6,3 bit holders

Design: Tough, for universal use

| |  | □, mm | □, " |
|-------------|---|----------|---------|
| 05066785001 | 1 | 89 | 3 1/2" |
| 05066786001 | 2 | 89 | 3 1/2" |
| 05066787001 | 3 | 89 | 3 1/2" |
| 05066780001 | 4 | 50 | 2" |
| 05066788001 | 4 | 89 | 3 1/2" |
| 05066782001 | 5 | 50 | 2" |
| 05066784001 | 6 | 50 | 2" |



5/16" hexagon drive, suitable for F 8 bit holders or direct drive (series 6)

875/6 TRI-WING® bits



Application: TRI-WING® screws

Drive: 5/16" hexagon, suitable for DIN ISO 1173-F 8 bit holders

Design: Tough, for universal use

| |  | □, mm | □, " | ∅ mm |
|-------------|---|----------|---------|---------|
| 05066790001 | 6 | 35 | 1 3/8" | 11,0 |
| 05066792001 | 7 | 35 | 1 3/8" | 11,0 |
| 05066794001 | 8 | 35 | 1 3/8" | 12,5 |



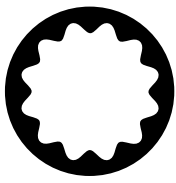

Bits for Multi-Point Screws



1/4" hexagon drive, suitable for D 6,3 bit holders (series 1)

860/1 XZN Multi-point bits



Application: Multi-point socket screws

Drive: 1/4" hexagon, suitable for DIN ISO 1173-D 6,3 bit holders

Design: Tough, for universal use

| | | mm | mm | mm |
|-------------|------|--------|--------|--------|
| 05066150001 | M 4 | 25 | 1" | 4,17 |
| 05066155001 | M 5 | 25 | 1" | 5,14 |
| 05066160001 | M 6 | 25 | 1" | - |
| 05066165001 | M 8 | 25 | 1" | 8,0 |
| 05066170001 | M 10 | 25 | 1" | 10,0 |



1/4" hexagon drive, suitable for F 6,3 bit holders (series 4)

860/4 XZN Multi-point bits



Application: Multi-point socket screws

Drive: 1/4" hexagon, suitable for DIN ISO 1173-F 6,3 bit holders

Design: Tough, for universal use

| | | mm | mm | mm |
|-------------|------|--------|--------|--------|
| 05066175001 | M 4 | 50 | 2" | 4,17 |
| 05066180001 | M 5 | 50 | 2" | 5,14 |
| 05066185001 | M 6 | 50 | 2" | - |
| 05066190001 | M 8 | 50 | 2" | 8,0 |
| 05066195001 | M 10 | 50 | 2" | 10,0 |
| 05066200001 | M 12 | 50 | 2" | 12,0 |

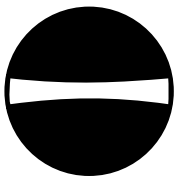

Bits for Hi-TORQUE Screws



1/4" hexagon drive, suitable for D 6,3 bit holders (series 1)

800/1 HTN Hi-TORQUE bits



Application: Hi-TORQUE screws

Drive: 1/4" hexagon, suitable for DIN ISO 1173-D 6,3 bit holders

| | | □, mm | □, |
|-------------|---|----------|--------|
| 05055950001 | 1 | 32 | 1 1/4" |
| 05055951001 | 2 | 32 | 1 1/4" |
| 05055952001 | 3 | 32 | 1 1/4" |
| 05055953001 | 4 | 32 | 1 1/4" |

700 A HTS Hi-TORQUE bits



Application: For Hi-TORQUE screws

Drive: 1/4"-square drive socket

| | | □, mm | □, |
|-------------|---|----------|----|
| 05040030001 | 0 | 25 | 1" |
| 05040031001 | 1 | 25 | 1" |
| 05040032001 | 2 | 25 | 1" |
| 05040033001 | 3 | 25 | 1" |
| 05040034001 | 4 | 25 | 1" |

700 B HTS Hi-TORQUE bits



Application: For Hi-TORQUE screws

Drive: 3/8"-square drive socket

| | | □, mm | □, |
|-------------|---|----------|--------|
| 05040040001 | 3 | 25 | 1" |
| 05040041001 | 4 | 25 | 1" |
| 05040042001 | 5 | 32 | 1 1/4" |
| 05040043001 | 6 | 32 | 1 1/4" |

700 C HTS Hi-TORQUE bits



Application: For Hi-TORQUE screws

Drive: 1/2"-square drive socket

| | | □, mm | □, |
|-------------|----|----------|--------|
| 05040045001 | 7 | 42 | 1 5/8" |
| 05040046001 | 8 | 42 | 1 5/8" |
| 05040047001 | 9 | 42 | 1 5/8" |
| 05040048001 | 10 | 42 | 1 5/8" |
| 05040049001 | 12 | 60 | 2 3/8" |





Bits for Microstix® Screws



4 mm 4 mm Halfmoon direct drive (series 9)

872/9 bits for Microstix® screws



Application: Microstix® socket screws
Drive: Halfmoon, 4 mm
Design: Precision hardened for sensitive applications

| | | l, mm | ∅ mm | l [*] " |
|-------------|----|----------|---------|---------------------|
| 05066850001 | m | 44 | 2,0 | 1 47/64 |
| 05066851001 | 00 | 44 | 2,0 | 1 47/64 |
| 05066852001 | F | 44 | 2,0 | 1 47/64 |
| 05066853001 | 0 | 44 | 2,0 | 1 47/64 |
| 05066854001 | 1 | 44 | 2,0 | 1 47/64 |



4 mm 4 mm HIOS direct drive (series 21)

872/21 bits for Microstix® screws



Application: Microstix® socket screws
Drive: HIOS 4 mm
Design: Precision hardened for sensitive applications

| | | l, mm | ∅ mm | l [*] " |
|-------------|----|----------|---------|---------------------|
| 05066860001 | m | 40 | 2,0 | 1 9/16 |
| 05066861001 | 00 | 40 | 2,0 | 1 9/16 |
| 05066862001 | F | 40 | 2,0 | 1 9/16 |
| 05066863001 | 0 | 40 | 2,0 | 1 9/16 |
| 05066864001 | 1 | 40 | 2,0 | 1 9/16 |



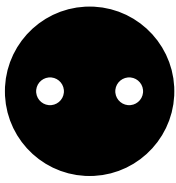

Bits for Spanner Screws



1/4" hexagon drive, suitable for D 6,3 bit holders (series 1)





857/1 Z Spanner bits



Application: Spanner screws

Drive: 1/4" hexagon, suitable for DIN ISO 1173-D 6,3 bit holders

Design: Tough, for universal use

| |  |  mm |  mm |  mm |
|-------------|---|---|---|---|
| 05057150001 | 4 | 25 | 1" | 3,18 |
| 05057151001 | 6 | 25 | 1" | 4,32 |
| 05057152001 | 8 | 25 | 1" | 5,21 |
| 05057153001 | 10 | 25 | 1" | 6,10 |



1/4" hexagon drive, suitable for F 6,3 bit holders (series 4)





857/4 Z Spanner bits



Application: Spanner screws

Drive: 1/4" hexagon, suitable for DIN ISO 1173-F 6,3 bit holders

Design: Tough, for universal use

| |  |  mm |  mm |  mm |
|-------------|---|---|---|---|
| 05057160001 | 4 | 89 | 3 1/2" | 3,18 |
| 05057161001 | 6 | 89 | 3 1/2" | 4,32 |
| 05057162001 | 8 | 89 | 3 1/2" | 5,21 |
| 05057163001 | 10 | 89 | 3 1/2" | 6,10 |

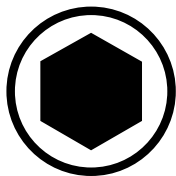





Nutsetters

 1/4" hexagon drive, suitable for F 6,3 bit holders (series 4)

3869/4 Nutsetters, stainless







Application: Hexagon headed bolts, screws and nuts
Drive: 1/4" hexagon, suitable for DIN ISO 1173-F 6,3 bit holders
Design: Non-magnetic, retaining spring, stainless steel for minimising rust

| |  mm |  mm |  mm |  mm |
|-------------|---|---|---|---|
| 05071222001 | 7,0 | | 50,0 | 12,5 |
| 05071223001 | 8,0 | | 50,0 | 14,0 |
| 05071224001 | 10,0 | | 50,0 | 16,0 |
| 05071225001 | 13,0 | | 50,0 | 19,5 |
| 05071228001 | | 3/8" | 50,0 | 16,0 |

869/4 Nutsetters



Application: Hexagon headed bolts, screws and nuts
Drive: 1/4" hexagon, suitable for DIN ISO 1173-F 6,3 bit holders
Design: Non-magnetic

| |  mm |  mm |  mm |  mm |
|-------------|---|---|---|---|
| 05060400001 | 5,5 | | 50,0 | 11,0 |
| 05060272001 | 5,5 | | 65,0 | 9,5 |
| 05060401001 | 6,0 | | 50,0 | 11,0 |
| 05060274001 | 6,0 | | 65,0 | 11,0 |
| 05060402001 | 7,0 | | 50,0 | 11,0 |
| 05060276001 | 7,0 | | 65,0 | 11,0 |
| 05060403001 | 8,0 | | 50,0 | 12,5 |
| 05060278001 | 8,0 | | 65,0 | 12,5 |
| 05060404001 | 9,0 | | 50,0 | 14,0 |
| 05060280001 | 9,0 | | 65,0 | 14,0 |
| 05060405001 | 10,0 | | 50,0 | 14,0 |
| 05060282001 | 10,0 | | 65,0 | 14,0 |
| 05060406001 | 11,0 | | 50,0 | 16,0 |
| 05060281001 | 11,0 | | 65,0 | 16,0 |
| 05060407001 | 12,0 | | 50,0 | 18,0 |
| 05060283001 | 12,0 | | 65,0 | 17,0 |
| 05060408001 | 13,0 | | 50,0 | 18,0 |
| 05060284001 | 13,0 | | 65,0 | 19,0 |
| 05060409001 | | 1/4" | 50,0 | 11,0 |
| 05060286001 | | 1/4" | 65,0 | 11,0 |
| 05060410001 | | 5/16" | 50,0 | 12,5 |
| 05060290001 | | 5/16" | 65,0 | 12,5 |
| 05060411001 | | 3/8" | 50,0 | 14,0 |
| 05060288001 | | 3/8" | 65,0 | 14,0 |
| 05060412001 | | 7/16" | 50,0 | 16,0 |



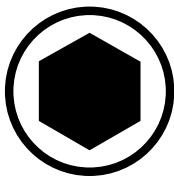

Nutsetters



1/4" hexagon drive, suitable for direct drive DIN ISO 1173-F 6,3 machine chucks (series 4)

869/4 M Nutsetters, magnetic



Application: Hexagon headed bolts, screws and nuts

Drive: 1/4" hexagon, suitable for DIN ISO 1173-F 6,3 bit holders

Design: Strong permanent magnet

| | mm | mm | mm | mm |
|-------------|-------|------|------|----|
| 05060420001 | 5,5 | 50,0 | 11,0 | |
| 05060210001 | 5,5 | 65,0 | 11,0 | |
| 05060421001 | 6,0 | 50,0 | 11,0 | |
| 05060215001 | 6,0 | 65,0 | 11,0 | |
| 05060422001 | 7,0 | 50,0 | 11,0 | |
| 05060220001 | 7,0 | 65,0 | 11,0 | |
| 05060423001 | 8,0 | 50,0 | 12,5 | |
| 05060225001 | 8,0 | 65,0 | 12,5 | |
| 05060424001 | 9,0 | 50,0 | 14,0 | |
| 05060230001 | 9,0 | 65,0 | 14,0 | |
| 05060425001 | 10,0 | 50,0 | 14,0 | |
| 05060235001 | 10,0 | 65,0 | 14,0 | |
| 05060426001 | 11,0 | 50,0 | 16,0 | |
| 05060237001 | 11,0 | 65,0 | 16,0 | |
| 05060427001 | 12,0 | 50,0 | 18,0 | |
| 05060238001 | 12,0 | 65,0 | 17,0 | |
| 05060428001 | 13,0 | 50,0 | 18,0 | |
| 05060240001 | 13,0 | 65,0 | 19,0 | |
| 05060429001 | 1/4" | 50,0 | 11,0 | |
| 05060255001 | 1/4" | 65,0 | 11,0 | |
| 05060430001 | 5/16" | 50,0 | 12,5 | |
| 05060260001 | 5/16" | 65,0 | 12,5 | |
| 05060431001 | 3/8" | 50,0 | 14,0 | |
| 05060265001 | 3/8" | 65,0 | 14,0 | |
| 05060432001 | 7/16" | 50,0 | 16,0 | |

869/4 M SB Nutsetters, magnetic

| | | 4013288 |
|-------------|-----------------|---------|
| 05073500001 | ● 1 x 5.5x50.0 | 105691 |
| 05073501001 | ● 1 x 6.0x50.0 | 105707 |
| 05073502001 | ● 1 x 7.0x50.0 | 106506 |
| 05073503001 | ● 1 x 8.0x50.0 | 105714 |
| 05073504001 | ● 1 x 9.0x50.0 | 105721 |
| 05073505001 | ● 1 x 10.0x50.0 | 105738 |
| 05073506001 | ● 1 x 11.0x50.0 | 105745 |
| 05073507001 | ● 1 x 12.0x50.0 | 105752 |
| 05073508001 | ● 1 x 13.0x50.0 | 105769 |
| 05073509001 | ● 1 x 1/4"x50.0 | 105776 |
| 05073510001 | ● 1 x 3/8"x50.0 | 105783 |



869/4 M Set A SB



8 piece set, with strong permanent magnet, in practical pouch for the belt

| | | 4013288 |
|-------------|---|---------|
| 05073495001 | 869/4 M ● 1 x 7.0x50.0; 1 x 8.0x50.0; 1 x 10.0x50.0; 1 x 12.0x50.0; 1 x 13.0x50.0; 1 x 1/4"x50.0; 1 x 5/16"x50.0; 1 x 3/8"x50.0 | 144584 |



4 mm 4 mm Halfmoon direct drive (series 9)

869/9 Nutsetters



Application: Hexagon headed bolts, screws and nuts

Drive: Halfmoon, 4 mm

Design: Non-magnetic

| | mm | mm | mm |
|-------------|-----|------|-----|
| 05135224001 | 2,5 | 44,0 | 5,0 |
| 05135225001 | 3,0 | 44,0 | 5,0 |

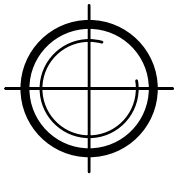

Internal Thread Insertion Tool



1/4" hexagon drive, suitable for F 6,3 bit holders (series 4)





879/4 Internal thread insertion tool



Application: Hanger bolts and threaded rods

Drive: 1/4" hexagon, suitable for DIN ISO 1173-F 6,3 bit holders









Design: Internal thread

| |  |  mm |  2" |  mm |
|-------------|---|---|---|---|
| 05135902001 | M6 | 50,0 | 2" | 8,0 |
| 05135903001 | M8 | 50,0 | 2" | 12,0 |
| 05135904001 | M10 | 50,0 | 2" | 12,0 |





Holders and Adaptors

| | | |
|---|--|------------|
|  | Impaktor Bit Holders | 410 |
|  | Rapidaptor Bit Holders | 414 |
|  | BiTorsion Bit Holders with Quick-Release Chuck | 418 |
|  | Universal Bit Holders with Quick-Release Chuck | 419 |
|  | Universal Bit Holders with Retaining Ring | 421 |
|  | Universal Bit Holders with Stainless Steel Sleeve | 422 |
|  | Universal Bit Holders with Copper Beryllium Sleeve | 424 |
|  | Bit Holder with Adjustable Depth-Control Stop | 425 |
|  | Adaptors | 426 |



Bit Holders and Adaptors

We were not happy that bit change with bit holders was often quite cumbersome. We found out that strong magnets or retaining rings indeed hold the bit securely, but they greatly impede removal from the holder.

So we have developed bit holders that indeed reliably hold the bit, yet still allow for fast and trouble-free bit change. The solution: bit holders with quick-release mechanisms that lift the bit from the magnets. Bit holders which – depending on the requirements – additionally have elastic zones that absorb peak loads. Or rapid-spin sleeves with which the cordless or electric screwdrivers can be guided during the screwdriving process.

Impaktor holder

Suitable for extra high torque e.g. from modern 18 volt impact screwdrivers with particularly high resilience. Reduces the risk of premature breakage of the holder or bit and increases the productivity when screwdriving with power tools.



Rapidaptor stainless steel

Manufactured out of stainless steel thus preventing the formation of unsightly extraneous rust when working with stainless steel. Additionally, it offers all the advantages of the Rapidaptor technology.



BiTorsion holder

Designed with special BiTorsion zone. The energy from peak loads is diverted into the BiTorsion zone. Considerable reduction of the risk of breakage, much longer service life.



Rapidaptor holder

Rapid bit change without needing any additional tools. One-hand operation with a freely spinning sleeve for simplified guidance of the tool. Also available in a BiTorsion design.



Ring magnet Rapidaptor

Special design powerful ring magnet, for larger and heavier screws. Ideal for overhead work, too.



Holder with quick-release chuck

The magnetic design enables simplified positioning of the screw. The non-magnetic version prevents any unwanted attraction of metal filings.



Universal holder with retaining ring
 Proven holder design, optimal fitting of the tool in the holder. Particularly robust for series applications.

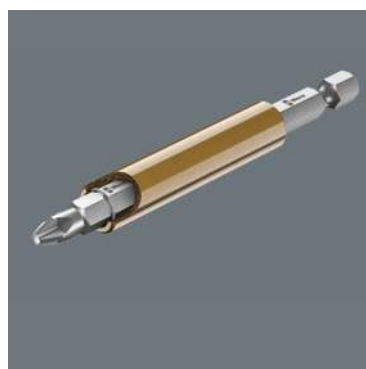

Copper Beryllium universal holder with retaining ring
 Very strong design thus minimising wear and tear. Particularly suitable for screw-driving jobs with high torque or peak loads. Very high resistance to corrosion.



Universal holder with stainless steel sleeve
 The retaining ring and the strong permanent magnet ensure a particularly secure fitting of the bit in the holder.



Impaktor Bits and Holders

Impaktor holder technology ensures an above-average service life even under extreme conditions thanks to a best-possible utilisation of the material properties and optimally designed geometry (two coupled torsion zones that perform successively).



The Impaktor stainless steel holder with a retaining ring and magnet satisfies the extreme, dynamic requirements in that there are consciously no small mechanical component parts fitted as they would be more susceptible to failure. It focuses on the basic bit holding function and the cushioning of the extreme impulse peaks with its two different torsion zones. Mainly used in industrial screw assembly applications e.g. with screwdriving robots.

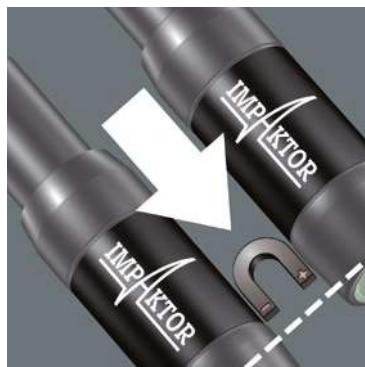

The Impaktor holder with ring magnet additionally holds longer and heavier screws absolutely securely. This enables a speedy and dependable positioning of the screw. It is also ideal for above-head work. Should the magnet function not be required in a particular situation e.g. when working with metal, it can be extracted from the screwdriving area and can thereby be “disabled”. Mainly used in manual power tool applications.



The combination of the double torsion zones in the Impaktor holder and the torsion zone in the Impaktor bit result in the so-called TriTorsion system.



Wera Impaktor bits and holders can also be used individually. However, the best results are achieved with the combination of the two tools that are optimally matched to one another.



Impaktor Bit Holders

For an above-average
service life

897/4 IMP Impaktor holder with retaining ring and magnet



Impaktor holder to cushion extreme impulse peaks, special torsion effect from the double-torsion spring, equipped with a retaining ring for a secure fit of the bits in the holder, holder out of stainless steel, fitted with magnet for a secure positioning of the bit and screw.

Output: Suitable for bits with 1/4" hexagon head drive as per DIN ISO 1173-C 6,3 and Wera Series 1

Design: The Impaktor technology ensures an above-average service life even under extreme conditions thanks to a best-possible utilisation of the material properties and optimally designed geometry (two coupled torsion zones that perform successively), fitted with strong retaining ring and magnet

Drive: 1/4" hexagon, suitable for power driven screwdrivers with DIN ISO 1173-F 6,3 chucks

| | | | | |
|-------------|------|----|----|------|
| | | | | |
| | | mm | | |
| 05057675001 | 1/4" | 75 | 3" | 1/4" |

897/4 IMP R Impaktor holder with retaining ring and ring magnet



Impaktor holder to cushion extreme impulse peaks, special torsion effect from the double-torsion spring, equipped with a ring magnet to easily hold longer and heavier screws, also ideal for above-head work, particularly suitable for use with impact drivers, the magnet can be retracted and in this way be disabled

Output: Suitable for bits with 1/4" hexagon head drive as per DIN ISO 1173-C 6,3 and Wera Series 1

Design: The Impaktor technology ensures an above-average service life even under extreme conditions thanks to a best-possible utilisation of the material properties and optimally designed geometry (two coupled torsion zones that perform successively), fitted with retaining ring and ring magnet

Drive: 1/4" hexagon, suitable for power driven screwdrivers with DIN ISO 1173-F 6,3 chucks

| | | | | |
|-------------|------|----|----|------|
| | | | | |
| | | mm | | |
| 05057676001 | 1/4" | 75 | 3" | 1/4" |

897/4 IMP R SB Impaktor holder with retaining ring and ring magnet

| | | |
|-------------|-------------|-------------------|
| | | |
| 05073990001 | 1 x 1/4"x75 | 4013288 157836 |





Rapidaptor Bit Holders

Wera developed the Rapidaptor that allows rapid bit change without any extra tools with only one hand.



Chuck-all

The Rapidaptor quick-release chucks hold both 1/4" bits as per DIN ISO 1173-C 6,3 (Wera series 1) and E 6,3 (Wera series 4).



Single-hand

All functions of the quick-release chuck such as the inserting or releasing of bits can be done with just one hand. That is faster, more economic and ergonomic. There are no unnecessary manoeuvres.



Rapid-in and self-lock

The bit can be pushed into the chuck without moving the sleeve. It automatically locks with a secure and wobble-free fit as soon as the bit is applied to the screw.



Rapid-out

Simply push the sleeve forward to change the bit. The spring mechanism lifts the bit off the magnet and unlocks the tool. The bit can be easily removed. Particularly helpful: even the smallest bits can be removed without any extra tools.



Rapid-spin

The free-turning sleeve allows screw steadying at the start of the screwdriving process. This makes it easier to apply the tool to the screw and prevents slipping. It can also be used as a short extension for 1/4" applications e.g. in combination with the Wera Zyklop Ratchets.



Rapidaptor with ring magnet

The floating, free-turning magnetic sleeve securely holds even large and heavy screws to enable immediate application. There is no need to hold the screw when applying the tool – something which can be dangerous and painful. Also ideal for overhead work.



Rapidaptor Bit Holders

For rapid bit changes

3888/4/1 K Rapidaptor Universal Bit Holder stainless



Application: Suitable for 1/4" DIN ISO 1173-C 6,3 and E 6,3 hexagon insert bits and Wera Series 1 and 4

Design: Rapidaptor rapid-in, rapid-out, rapid-spin, chuck-all and single-hand Technology; stainless steel for minimising rust

Drive: 1/4" hexagon, suitable for power tools with DIN ISO 1173-F 6,3 chuck

| | mm | mm | mm | mm | mm |
|-------------|------|----|----|------|------|
| 05071100001 | 1/4" | 50 | 2" | 1/4" | 15,0 |

3888/4/1 K SB Rapidaptor Universal Bit Holder, stainless

| | | 4013288 |
|-------------|-------------|---------|
| 05073616001 | 1 x 1/4"x50 | 112170 |



897/4 R Rapidaptor BiTorsion Universal Bit Holder



Application: Suitable for 1/4" DIN ISO 1173-C 6,3 and E 6,3 hexagon insert bits and Wera Series 1 and 4

Design: BiTorsion for long service life, Rapidaptor rapid-in, rapid-out, rapid-spin, chuck-all, and single-hand technology

Drive: 1/4" hexagon suitable for power tools with DIN ISO 1173-F 6,3 receiver

| | mm | mm | mm | mm | mm |
|-------------|------|----|----|------|------|
| 05053923001 | 1/4" | 75 | 3" | 1/4" | 15,0 |

897/4 R SB Rapidaptor BiTorsion Universal Bit Holder

| | | 4013288 |
|-------------|-------------|---------|
| 05073420001 | 1 x 1/4"x75 | 099464 |







889/4/1 K Rapidaptor Universal Bit Holder





Application: Suitable for 1/4" DIN ISO 1173-C 6,3 and E 6,3 hexagon insert bits and Wera Series 1 and 4

Design: Rapidaptor rapid-in, rapid-out, rapid-spin, chuck-all, and single-hand technology, with strong permanent magnet

Drive: 1/4" hexagon suitable for power tools with DIN ISO 1173-F 6,3 receiver

| |  |  |  |  |  |
|-------------|---|---|---|---|---|
| | mm | mm | mm | mm | mm |
| 05052502001 | 1/4" | 50 | 2" | 1/4" | 15,0 |

889/4/1 K SB Rapidaptor Universal Bit Holder

|  |  |
|---|---|
| 05073421001 | 4013288 |
| ●● 1 x 1/4"x50 | 099440 |



Tip



BiTorsion Rapidaptor



BiTorsion holders from Wera have a torsion spring design that absorbs smaller peak loads during screwdriving. The combined use with BiTorsion bits with their torsion zone distinctly extends the service life of the tool. Conveniently, BiTorsion holders from Wera can also be used with conventional bits.



Rapidaptor holder out of stainless steel



Manufactured out of stainless steel thus preventing the formation of unsightly extraneous rust when working with stainless steel. Additionally, it offers all the advantages of the Rapidaptor technology.



Rapidaptor Bit Holders

For rapid bit changes





889/4/1 Rapidaptor Universal Bit Holder



Application: Suitable for 1/4" DIN ISO 1173-C 6,3 and E 6,3 hexagon insert bits and Wera Series 1 and 4

Design: Rapidaptor easy-in, easy-out, rapid-spin, chuck-all, and single-hand technology, with strong permanent magnet

Drive: 1/4" hexagon suitable for power tools with DIN ISO 1173-F 6,3 receiver

| |  |  |  |  |  |
|-------------|---|---|---|---|---|
| | 1/4" | mm | 3" | 1/4" | mm |
| 05052503001 | 1/4" | 75 | 3" | 1/4" | 15,0 |





888/4/1 K Rapidaptor Universal Bit Holder



Application: Suitable for 1/4" DIN ISO 1173-C 6,3 and E 6,3 hexagon insert bits and Wera Series 1 and 4

Design: Rapidaptor easy-in, easy-out, rapid-spin, chuck-all, and single-hand technology

Drive: 1/4" hexagon suitable for power tools with DIN ISO 1173-F 6,3 receiver

| |  |  |  |  |  |
|-------------|---|---|---|---|---|
| | 1/4" | mm | 2" | 1/4" | mm |
| 05052500001 | 1/4" | 50 | 2" | 1/4" | 15,0 |





889/4 R Rapidaptor Universal Bit Holder



Application: Suitable for 1/4" DIN ISO 1173-C 6,3 and E 6,3 hexagon insert bits and Wera Series 1 and 4

Drive: 1/4" hexagon suitable for power tools with DIN ISO 1173-F 6,3 receiver

Design: 1/4" hexagon with Rapidaptor rapid-in, rapid-out, rapid-spin, chuck-all, and single-hand technology, magnetic

| |  |  |  |  |  |
|-------------|---|---|---|---|---|
| | 1/4" | mm | 4" | 1/4" | mm |
| 05052504001 | 1/4" | 100 | 4" | 1/4" | 15,0 |

887/4 RR Rapidaptor Universal Bit Holder with ring magnet



Application: Suitable for 1/4" DIN ISO 1173-C 6,3 and E 6,3 hexagon insert bits and Wera Series 1 and 4

Design: Rapidaptor rapid-in, rapid-out, rapid-spin, chuck-all, and single-hand technology, with ring magnet and stop sleeve for secure screwdriving on the holder

Drive: 1/4" hexagon suitable for power tools with DIN ISO 1173-F 6,3 receiver

| | 1/4" | mm | mm | 1/4" | mm |
|-------------|------|-----|--------|------|----|
| 05052490001 | 1/4" | 57 | 2 1/4" | 1/4" | 16 |
| 05160987001 | 1/4" | 89 | 3 1/2" | 1/4" | 16 |
| 05160988001 | 1/4" | 152 | 6" | 1/4" | 16 |

887/4 RR SB Rapidaptor Universal Bit Holder with ring magnet

| | | |
|-------------|---------------|---------|
| | | 4013288 |
| 05073511001 | ⊙ 1 x 1/4"x57 | 105790 |



Tip

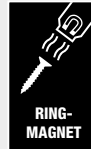

Rapidaptor ring magnet



The floating, free-turning sleeve on the Rapidaptor with powerful ring magnet securely holds even large and heavy screws.

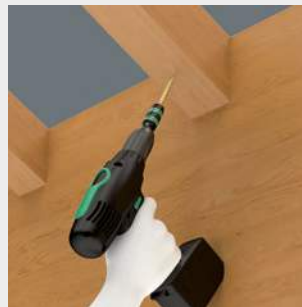

There is no need to hold the screw when applying the tool – something which can be dangerous and painful!



BiTorsion Quick-Release Chuck Holders

Adaptor for hexagon to square drive

797 A/4/1 B BiTorsion Bit Holder



Application: Suitable for 1/4" DIN ISO 1173-C 6,3 and E 6,3 hexagon insert bits and Wera Series 1 and 4

Design: BiTorsion for long service life, with strong permanent magnet

Drive: 1/4"-female square socket for use with ratchet or power tool

| | 1/4" | mm | 3" | 1/4" | mm |
|-------------|------|----|----|------|------|
| 05048681001 | 1/4" | 77 | 3" | 1/4" | 14,0 |

797 B/4/1 B BiTorsion Bit Holder



Application: Suitable for 1/4" DIN ISO 1173-C 6,3 and E 6,3 hexagon insert bits and Wera Series 1 and 4

Design: BiTorsion for long service life, with strong permanent magnet

Drive: 3/8"-female square socket for use with ratchet or power tool

| | 1/4" | mm | 3 1/4" | 3/8" | mm |
|-------------|------|----|--------|------|------|
| 05048680001 | 1/4" | 82 | 3 1/4" | 3/8" | 14,0 |

Universal Bit Holders with Quick-Release Chuck

Secure hold and rapid bit changes





894/4/1 K Universal Bit Holder



Application: Suitable for 1/4" DIN ISO 1173-C 6,3 hexagon insert bits and Wera Series 1

Design: With quick-release chuck

Drive: 1/4" hexagon, suitable for power tools with DIN ISO 1173-F 6,3 receiver

| |  |  |  |  |  |
|-------------|---|---|---|---|---|
| | mm | mm | mm | mm | mm |
| 05053522001 | 1/4" | 51 | 2" | 1/4" | 14,3 |





894/4/1 Universal Bit Holder



Application: Suitable for 1/4" DIN ISO 1173-C 6,3 hexagon insert bits and Wera Series 1

Design: With quick-release chuck

Drive: 1/4" hexagon, suitable for power tools with DIN ISO 1173-F 6,3 receiver

| |  |  |  |  |  |
|-------------|---|---|---|---|---|
| | mm | mm | mm | mm | mm |
| 05053520001 | 1/4" | 75 | 3" | 1/4" | 14,3 |





894/14/1 Universal Bit Holder



Application: Suitable for 1/4" DIN ISO 1173-C 6,3 hexagon insert bits and Wera Series 1

Design: With quick-release chuck

Drive: SDS plus

| |  |  |  |  |  |
|-------------|---|---|---|---|---|
| | mm | mm | mm | mm | mm |
| 05053560001 | 1/4" | 75 | 3" | 14,3 | |





895/4/1 K Universal Bit Holder







Application: Suitable for 1/4" DIN ISO 1173-C 6,3 hexagon insert bits and Wera Series 1

Design: With strong permanent magnet and quick-release chuck

Drive: 1/4" hexagon, suitable for power tools with DIN ISO 1173-F 6,3 receiver

| |  |  |  |  |  |
|-------------|---|---|---|---|---|
| | mm | mm | mm | mm | mm |
| 05053872001 | 1/4" | 52 | 2" | 1/4" | 14,3 |

895/4/1 K SB Universal Bit Holder

| | |
|---|---|
|  |  |
| 05073318001 | 4013288 |
|  | 029195 |
|  | 1 x 1/4"x52 |



Universal Bit Holder with Quick-Release Chuck

Secure hold and rapid bit changes

895/4/1 Universal Bit Holder



Application: Suitable for 1/4" DIN ISO 1173-C 6,3 hexagon insert bits and Wera Series 1

Design: With strong permanent magnet and quick-release chuck

Drive: 1/4" hexagon, suitable for power tools with DIN ISO 1173-F 6,3 receiver

| | | mm | | | mm |
|-------------|------|----|----|------|------|
| 05053870001 | 1/4" | 77 | 3" | 1/4" | 14,3 |

898/4 Combination Bit Holder



Application: Suitable for bits with 4 mm Halfmoon drive (and Wera Serie 9) and 4 mm HIOS drive (and Wera Series 21)

Design: With quick-release chuck

Drive: 1/4" hexagon, suitable for power tools with DIN ISO 1173-F 6,3 receiver

| | mm | | | mm |
|-------------|----|----|------|------|
| 05051500001 | 50 | 2" | 1/4" | 10,0 |

895/14/1 Universal Bit Holder



Application: Suitable for 1/4" DIN ISO 1173-C 6,3 hexagon insert bits and Wera Series 1

Design: With strong permanent magnet and quick-release chuck

Drive: SDS plus

| | | mm | | mm |
|-------------|------|----|--------|------|
| 05053920001 | 1/4" | 81 | 3 1/8" | 14,3 |

898/9 Combination Bit Holder



Application: Suitable for bits with 4 mm Halfmoon drive (and Wera Serie 9) and 4 mm HIOS drive (and Wera Series 21)

Design: With quick-release chuck

Drive: Halfmoon, 4 mm

| | mm | | mm |
|-------------|----|----|------|
| 05051501001 | 50 | 2" | 10,0 |

898/21 Combination Bit Holder



Application: Suitable for bits with 4 mm Halfmoon drive (and Wera Serie 9) and 4 mm HIOS drive (and Wera Series 21)

Design: With quick-release chuck

Drive: HIOS 4 mm

| | mm | | mm |
|-------------|----|----|------|
| 05051502001 | 50 | 2" | 10,0 |





Universal Bit Holder with Retaining Ring

Proven, secure hold in series manufacturing applications

890/00/0 Universal Bit Holder





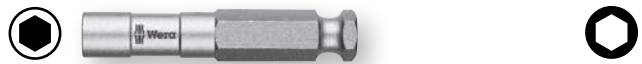

Application: Suitable for 4 mm DIN ISO 1173-C 4 bits
Design: With retaining ring
Drive: 3 mm hexagon, suitable for power tools with DIN ISO 1173-B 3 receiver

| |  |  |  |  |  |
|-------------|---|---|---|---|---|
| | mm | mm | mm | mm | mm |
| 05052505001 | 4 | 57 | 2 1/4" | 3 | 6,3 |

890/7/1 Universal Bit Holder







Application: Suitable for 1/4" DIN ISO 1173-C 6,3 hexagon insert bits and Wera Series 1
Design: With retaining ring
Drive: 7/16" hexagon, suitable for power tools with DIN ISO 1173-F 11,2 receiver

| |  |  |  |  |  |
|-------------|---|---|---|---|---|
| | mm | mm | mm | mm | mm |
| 05052655001 | 1/4" | 65 | 2 1/2" | 7/16" | 11,1 |

890/4/1 Universal Bit Holder







Application: Suitable for 1/4" DIN ISO 1173-C 6,3 hexagon insert bits and Wera Series 1
Design: With retaining ring
Drive: 1/4" hexagon, suitable for power tools with DIN ISO 1173-F 6,3 receiver

| |  |  |  |  |  |
|-------------|---|---|---|---|---|
| | mm | mm | mm | mm | mm |
| 05052575001 | 1/4" | 57 | 2 1/4" | 1/4" | 11,1 |

890/7/2 Universal Bit Holder







Application: Suitable for 5/16" DIN ISO 1173-C 8 hexagon insert bits and Wera Series 2
Design: With retaining ring
Drive: 7/16" hexagon, suitable for power tools with DIN ISO 1173-F 11,2 receiver

| |  |  |  |  |  |
|-------------|---|---|---|---|---|
| | mm | mm | mm | mm | mm |
| 05052725001 | 5/16" | 65 | 2 1/2" | 7/16" | 14,3 |

890/6/1 Universal Bit Holder



Application: Suitable for 1/4" DIN ISO 1173-C 6,3 hexagon insert bits and Wera Series 1
Design: With retaining ring
Drive: 5/16" hexagon, suitable for power tools with DIN ISO 1173-F 8 receiver

| |  |  |  |  |  |
|-------------|---|---|---|---|---|
| | mm | mm | mm | mm | mm |
| 05052625001 | 1/4" | 65 | 2 1/2" | 5/16" | 11,1 |



Universal Bit Holders with Stainless Steel Sleeve

Strong magnet for secure hold





893/4/1 K Universal Bit Holder



Application: Suitable for 1/4" DIN ISO 1173-C 6,3 hexagon insert bits and Wera Series 1

Design: With stainless steel sleeve and strong permanent magnet

Drive: 1/4" hexagon, suitable for power tools with DIN ISO 1173-F 6,3 receiver

| |  |  |  |  |  |
|-------------|---|---|---|---|---|
| | 1/4" | 50 | 2" | 1/4" | 10,5 |
| 05134480001 | | | | | |





899/3/1 Universal Bit Holder





Application: Suitable for 1/4" DIN ISO 1173-C 6,3 hexagon insert bits and Wera Series 1

Design: With stainless steel sleeve, retaining ring, and strong permanent magnet

Drive: 5.5 mm hexagon, suitable for power tools with DIN ISO 1173-B 5,5 receiver

| |  |  |  |  |  |
|-------------|---|---|---|---|---|
| | 1/4" | 72 | 2 3/4" | 5,5 | 10,5 |
| 05053425001 | | | | | |

893/4/1 K SB Universal Bit Holder

| | | |
|--|-------------|---|
|  | |  |
| 05073401001 | 1 x 1/4"x50 | 4013288 029133 |







899/4/1 Universal Bit Holder





Application: Suitable for 1/4" DIN ISO 1173-C 6,3 hexagon insert bits and Wera Series 1

Design: With stainless steel sleeve, retaining ring, and strong permanent magnet

Drive: 1/4" hexagon, suitable for power tools with DIN ISO 1173-F 6,3 receiver

| | |  |  |  |  |  |
|-------------|-------------|---|---|---|---|---|
| | | 1/4" | 50 | 2" | 1/4" | 10,5 |
| 05053457001 | 899/4/1 K | | | | | |
| 05053455001 | 899/4/1 75 | | 75 | 3" | 1/4" | 10,5 |
| 05053459001 | 899/4/1 100 | | 100 | 4" | 1/4" | 10,5 |
| 05053458001 | 899/4/1 152 | | 152 | 6" | 1/4" | 10,5 |

899/4/1 SB Universal Bit Holder

| | | |
|---|-----------------------------|---|
|  | |  |
| 05347100001 | 1 x 899/4/1 K 50 1/4"x50 | 4013288 095268 |
| 05073357001 | 1 x 899/4/1 75 1/4"x75 | 029720 |
| 05134398001 | 1 x 899/4/1 152 1/4"x152 | 099907 |







899/4/1 S Universal Bit Holder with strong retaining ring



Application: Suitable for 1/4" DIN ISO 1173-C 6,3 hexagon insert bits and Wera Series 1

Design: With stainless steel sleeve, strong retaining ring, and strong permanent magnet

Drive: 1/4" hexagon, suitable for power tools with DIN ISO 1173-F 6,3 receiver

| |  |  |  |  |  |
|-------------|---|---|---|---|---|
| | 1/4" | mm | mm | 1/4" | mm |
| 05160976001 | 1/4" | 50 | 2" | 1/4" | 10,5 |
| 05160924001 | 1/4" | 75 | 3" | 1/4" | 10,5 |
| 05160977001 | 1/4" | 100 | 4" | 1/4" | 10,5 |
| 05160979001 | 1/4" | 200 | 8" | 1/4" | 10,5 |
| 05160981001 | 1/4" | 300 | 12" | 1/4" | 10,5 |





899/8/1 Universal Bit Holder



Application: Suitable for 1/4" DIN ISO 1173-C 6,3 hexagon insert bits and Wera Series 1

Design: With stainless steel sleeve, retaining ring, and strong permanent magnet

Drive: 7 mm, suitable for power tools with DIN ISO 1173-H 7 receiver

| |  |  |  |  |  |
|-------------|---|---|---|---|---|
| | 1/4" | mm | mm | mm | mm |
| 05053475001 | 1/4" | 75 | 3" | 7 | 10,5 |





899/5/1 Universal Bit Holder



Application: Suitable for 1/4" DIN ISO 1173-C 6,3 hexagon insert bits and Wera Series 1

Design: With stainless steel sleeve, retaining ring, and strong permanent magnet

Drive: 5/16" hexagon

| |  |  |  |  |  |
|-------------|---|---|---|---|---|
| | 1/4" | mm | mm | 5/16" | mm |
| 05053460001 | 1/4" | 45 | 1 3/4" | 5/16" | 10,5 |





899/8/1 K Universal Bit Holder



Application: Suitable for 1/4" DIN ISO 1173-C 6,3 hexagon insert bits and Wera Series 1

Design: With stainless steel sleeve, retaining ring, and strong permanent magnet

Drive: 7 mm, suitable for power tools with DIN ISO 1173-H 7 receiver

| |  |  |  |  |  |
|-------------|---|---|---|---|---|
| | 1/4" | mm | mm | mm | mm |
| 05053480001 | 1/4" | 55 | 2 3/16" | 7 | 10,5 |





899/14/1 Universal Bit Holder



Application: Suitable for 1/4" DIN ISO 1173-C 6,3 hexagon insert bits and Wera Series 1

Design: With stainless steel sleeve, retaining ring, and strong permanent magnet

Drive: SDS plus

| |  |  |  |  |
|-------------|---|---|---|---|
| | 1/4" | mm | mm | mm |
| 05053485001 | 1/4" | 79 | 3 1/8" | 10,5 |

899/14/1 SB Universal Bit Holder

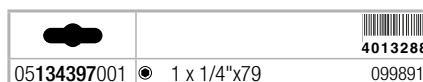

Universal Bit Holders with Copper Beryllium Sleeve

Very high torque model





891/4/1 Universal Bit Holder



Application: Suitable for 1/4" DIN ISO 1173-C 6,3 hexagon insert bits and Wera Series 1

Design: With CuBe sleeve, retaining ring, and strong permanent magnet

Drive: 1/4" hexagon, suitable for power tools with DIN ISO 1173-F 6,3 receiver

| |  |  mm |  mm |  |  mm |
|-------------|---|---|---|---|---|
| 05053175001 | 1/4" | 75 | 3" | 1/4" | 10,5 |



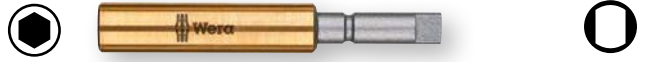

891/8/1 Universal Bit Holder



Application: Suitable for 1/4" DIN ISO 1173-C 6,3 hexagon insert bits and Wera Series 1

Design: With CuBe sleeve, retaining ring, and strong permanent magnet

Drive: 7 mm, suitable for power tools with DIN ISO 1173-H 7 receiver

| |  |  mm |  mm |  mm |  mm |
|-------------|---|---|---|---|---|
| 05053275001 | 1/4" | 75 | 3" | 7 | 10,5 |

Bit Holder with Adjustable Depth-Control Stop

With infinite adjustment feature



896/4/1 SB Bit Holder with adjustable depth-control stop



Application: Suitable for 1/4" DIN ISO 1173-C 6,3 hexagon insert bits and Wera Series 1

Design: High quality aluminium spacers with infinite adjustment feature

Drive: 1/4" hexagon, suitable for power tools with DIN ISO 1173-F 6,3 receiver

| | | |
|---|---------------|---|
|  | |  |
| 05073210001 | 896/4/1 | 4013288 |
| | ◎ 1 x 1/4"x50 | 178725 |

Tip

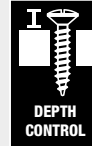

Bit holder with adjustable depth stop



The screw installation depth can be infinitely adjusted and allows the desired degree of countersinking of the screws.



Adaptors

870/1 Adaptor



Application: Nut spinner sockets
Drive: 1/4" external hexagon
Output: 1/4" external square

| | | mm | | |
|---------------------------|------|----|----|------|
| 05136000001 ¹⁾ | 1/4" | 25 | 1" | 1/4" |

¹⁾ With friction ball; for manual nut spinner sockets

870/2 Adaptor



Application: Nut spinner sockets
Drive: External hexagon
Output: External square

| | | mm | | |
|---------------------------|------|----|---------|-------|
| 05136001001 ¹⁾ | 3/8" | 30 | 1 3/16" | 5/16" |
| 05136002001 ¹⁾ | 1/2" | 35 | 1 3/8" | 5/16" |

¹⁾ With friction ball; for manual nut spinner sockets

870/4 Adaptor



Application: Manual nut spinner sockets
Drive: 1/4" hexagon
Output: 1/4" external square

| | | mm | | |
|---------------------------|------|----|----|------|
| 05311517001 ¹⁾ | 1/4" | 50 | 2" | 1/4" |

¹⁾ With friction ball; for manual nut spinner sockets

870/4 SB

| 05134399001 ¹⁾ | OO | 1 x 1/4"x50 | | 099914 |
|---------------------------|----|-------------|--|--------|

¹⁾ With friction ball; for manual nut spinner sockets



870/4/7 Set A SB



Application: Machine-operated nut spinner sockets

Design: With external square drive

Drive: 1/4" hexagon, suitable for power tools with DIN ISO 1173-F 6,3 receiver; 7/16" hexagon, suitable for power tools with DIN ISO 1173-F 11,2 receiver

| | | |
|------------|--------------------------|--|
| 0507320001 | | |
| 870/4 | 1 x 1/4"x50; 1 x 3/8"x50 | |
| 870/7 | 1 x 1/2"x75 | |

870/4 Adaptor



Application: Machine-operated nut spinner sockets

Design: With external square drive

Drive: 1/4" hexagon, suitable for power tools with DIN ISO 1173-F 6,3 receiver

| 05050205001 | 1/4" | 50 | 2" | 1/4" |
|-------------|------|-----|----|------|
| 05050210001 | 1/4" | 100 | 4" | 1/4" |
| 05050215001 | 3/8" | 50 | 2" | 1/4" |
| 05050220001 | 3/8" | 100 | 4" | 1/4" |

870/14 Adaptor



Application: Machine-operated nut spinner sockets

Design: With external square drive

Drive: SDS plus

| 05050650001 | 1/4" | 70 | 2 3/4" |
|-------------|------|----|--------|

870/7 Adaptor



Application: Machine-operated nut spinner sockets

Design: With external square drive

Drive: 7/16" hexagon, suitable for power tools with DIN ISO 1173-F 11,2 receiver

| 05050510001 | 1/2" | 75 | 3" | 7/16" |
|-------------|------|----|----|-------|



Adaptors

784 A 1/4" Adaptor with quick-release chuck



Application: Suitable for 1/4" DIN ISO 1173-C 6,3 hexagon insert bits and Wera Series 1

Design: With Wera quick-release chuck

Drive: 1/4" female square

| |  |  |  |  |
|-------------|---|---|---|---|
| | mm | | | |
| 05042750001 | 784 A/1 | 1/4" | 30 | 1 3/16" 1/4" |





784 B 3/8" Adaptor with quick-release chuck



Application: Suitable for 1/4" DIN ISO 1173-C 6,3 and 5/16" DIN ISO 1173-C 8 hexagon insert bits and Wera Series 1 and 2

Design: With Wera quick-release chuck

Drive: 3/8" female square

| |  |  |  |  |
|-------------|---|---|---|---|
| | mm | | | |
| 05042755001 | 784 B/1 | 1/4" | 43 | 1 5/8" 3/8" |
| 05042765001 | 784 B/2 | 5/16" | 50 | 2" 3/8" |





784 C 1/2" Adaptor with quick-release chuck



Application: Suitable for 1/4" DIN ISO 1173-C 6,3 and 5/16" DIN ISO 1173-C 8 hexagon insert bits and Wera Series 1 and 2

Design: With Wera quick-release chuck

Drive: 1/2" female square

| |  |  |  |  |
|-------------|---|---|---|---|
| | mm | | | |
| 05042760001 | 784 C/1 | 1/4" | 50 | 2" 1/2" |
| 05042768001 | 784 C/2 | 5/16" | 50 | 2" 1/2" |

780 A 1/4" Adaptor



Application: Suitable for 1/4" DIN ISO 1173-C 6,3 hexagon insert bits and Wera Series 1

Drive: 1/4" female square





| |  |  |  |  |
|-------------|---|---|---|---|
| | mm | | | |
| 05042605001 | 780 A/1 | 1/4" | 25 | 1" 1/4" |

780 B 3/8" Adaptor



Application: Suitable for 1/4" DIN ISO 1173-C 6,3 and 5/16" DIN ISO 1173-C 8 hexagon insert bits and Wera Series 1 and 2

Drive: 3/8" female square

| |  |  |  |  |
|---------------------------|---|---|---|---|
| | mm | | | |
| 05042655001 | 780 B/1 | 1/4" | 30 | 1 3/16" 3/8" |
| 05344511001 ¹⁾ | 780 B/1-S | 1/4" | 30 | 1 3/16" 3/8" |
| 05042665001 | 780 B/2 | 5/16" | 30 | 1 3/16" 3/8" |
| 05344512001 ¹⁾ | 780 B/2-S | 5/16" | 30 | 1 3/16" 3/8" |





¹⁾ S = extra strong

780 C 1/2" Adaptor



Application: Suitable for 1/4" DIN ISO 1173-C 6,3, 5/16" DIN ISO 1173-C 8, 7/16" DIN ISO 1173-E 11,2, 5/8" hexagon insert bits and Wera Series 1, 2, 6, 7 and 19









Drive: 1/2" female square

| |  |  |  |  |
|-------------|---|---|---|---|
| | mm | | | |
| 05042705001 | 780 C/1 | 1/4" | 35 | 1 3/8" 1/2" |
| 05344513001 | 780 C/1-S | 1/4" | 35 | 1 3/8" 1/2" |
| 05042715001 | 780 C/2 | 5/16" | 35 | 1 3/8" 1/2" |
| 05344514001 | 780 C/2-S | 5/16" | 35 | 1 3/8" 1/2" |





Bit Sets

| | | |
|---|-----------------------------------|------------|
|  | Bit-Checks Impaktor | 434 |
|  | Bit-Checks Stainless | 438 |
|  | Bit-Checks / Bit-Safes BiTorsion | 440 |
|  | Bit-Checks Diamond | 444 |
|  | Bit-Checks / Bit-Safes Universal | 448 |
|  | Bit-Checks Wood | 458 |
|  | Bit-Checks Metal | 460 |
|  | Bit Sets For Special Applications | 461 |



Bit Ranges

We have had bit ranges in our programme for many years now. In 2016, we put a question mark against everything and came up with a game changer.

We wanted bit ranges with bits whose profiles and sizes could be more easily recognised. We wanted bit ranges that were as compact as possible and which were Wera-like at a first glance. We wanted bit ranges with bits that could be removed and reinserted more easily. We wanted bit ranges with as little weight as possible. The new multi-component Bit-Checks satisfy these requirements; the soft material in the lower section of the Bit-Checks ensures that the bits are firmly held yet easy to remove.



The bit ranges comprise sets of between 6 and 61 pieces. They offer the right tool set for every user.



The Bit-Checks by Wera are extremely compact and are therefore the ideal companion for mobile applications.



The Bit-Checks can be positioned upright at the workplace so the tool is always quickly to hand.

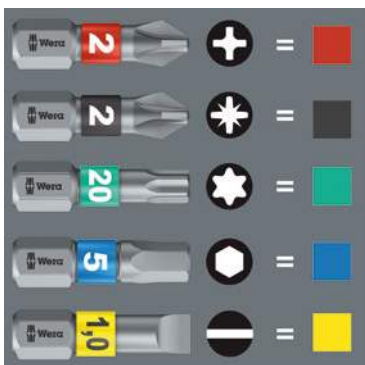

The “Take it easy” Bit-Checks have bits with a sleeve which – from its colour (e.g. red = Phillips) and size designation – make it simple to access the right bit quickly.



The new Bit-Safes provide users with comprehensive bit and holder ranges in a surface-protecting, compact textile box.



Bit-Checks Impaktor

For an above-average service life

Bit-Check 30 Impaktor 1



1 Impaktor holder with retaining ring and ring magnet in the chuck for a secure fit of the bits in the holder, 29 Impaktor bits. The "Take it easy" Bit-Checks have bits with a sleeve which – from its colour and size designation – make it simple to access the right bit quickly.

| | |
|-------------|--|
| 05057690001 | |
| ●○ | 897/4 1 x 1/4"x75 Impaktor R |
| + | 851/1 IMP DC 2 x PH 1x25; 3 x PH 2x25; 2 x PH 3x25 |
| + | 855/1 IMP DC 2 x PZ 1x25; 3 x PZ 2x25; 2 x PZ 3x25 |
| ⊕ | 867/1 IMP DC 1 x TX 10x25; 1 x TX 15x25; 2 x TX 20x25; 3 x TX 25x25; 2 x TX 30x25; 2 x TX 40x25 |
| ○ | 840/1 IMP DC 1 x 3,0x25; 1 x 4,0x25; 1 x 5,0x25; 1 x 6,0x25 |

Bit-Check 10 Impaktor 1



1 Impaktor holder with retaining ring and ring magnet in the chuck for a secure fit of the bits in the holder, 9 Impaktor bits. The "Take it easy" Bit-Checks have bits with a sleeve which – from its colour and size designation – make it simple to access the right bit quickly.

| | |
|-------------|---|
| 05057680001 | |
| ●○ | 897/4 1 x 1/4"x75 Impaktor R |
| + | 851/1 IMP DC 1 x PH 2x25; 1 x PH 3x25 |
| + | 855/1 IMP DC 1 x PZ 2x25; 1 x PZ 3x25 |
| ⊕ | 867/1 IMP DC 1 x TX 20x25; 1 x TX 25x25; 1 x TX 30x25 |
| ○ | 840/1 IMP DC 1 x 4,0x25; 1 x 5,0x25 |

Bit-Check 10 Impaktor 2



1 Impaktor holder with retaining ring and ring magnet in the chuck for a secure fit of the bits in the holder, 9 Impaktor bits. The "Take it easy" Bit-Checks have bits with a sleeve which – from its colour and size designation – make it simple to access the right bit quickly.

| | |
|-------------|---|
| 05057682001 | |
| ●○ | 897/4 1 x 1/4"x75 Impaktor R |
| + | 851/1 IMP DC 3 x PH 2x25; 1 x PH 3x25 |
| ⊕ | 867/1 IMP DC 3 x TX 25x25; 1 x TX 30x25; 1 x TX 40x25 |

Bit-Check 10 Impaktor 1 SB

| | | |
|-------------|---|---------|
| | | 4013288 |
| 05073980001 | | 158574 |
| ●○ | 897/4 Impaktor R 1 x 1/4"x75 | |
| + | 851/1 IMP DC 1 x PH 2x25; 1 x PH 3x25 | |
| + | 855/1 IMP DC 1 x PZ 2x25; 1 x PZ 3x25 | |
| ⊕ | 867/1 IMP DC 1 x TX 20x25; 1 x TX 25x25; 1 x TX 30x25 | |
| ○ | 840/1 IMP DC 1 x 4,0x25; 1 x 5,0x25 | |



Bit-Check 10 Impaktor 3



1 Impaktor holder with retaining ring and ring magnet in the chuck for a secure fit of the bits in the holder, 9 Impaktor bits. The "Take it easy" Bit-Checks have bits with a sleeve which – from its colour and size designation – make it simple to access the right bit quickly.

| | |
|-------------|---|
| 05057683001 | |
| ●○ | 897/4 1 x 1/4"x75 Impaktor R |
| + | 855/1 IMP DC 3 x PZ 2x25; 1 x PZ 3x25 |
| ⊕ | 867/1 IMP DC 3 x TX 25x25; 1 x TX 30x25; 1 x TX 40x25 |

Bit-Check 10 Impaktor 4



1 Impaktor holder with retaining ring and magnet in the chuck for a secure fit of the bits in the holder, 9 Impaktor bits. The “Take it easy” Bit-Checks have bits with a sleeve which – from its colour and size designation – make it simple to access the right bit quickly.

| | |
|-------------|---|
| 05057417001 | |
| ● ○ | 897/4 1 x 1/4"x75 |
| | Impaktor |
| + | 855/1 IMP DC 3 x PZ 2x25; 1 x PZ 3x25 |
| + | 867/1 IMP DC 2 x TX 20x25; 2 x TX 25x25; 1 x TX 30x25 |

Bit-Check 10 PZ Impaktor 1



1 Impaktor holder with retaining ring and ring magnet in the chuck for a secure fit of the bits in the holder, 9 Impaktor bits. The “Take it easy” Bit-Checks have bits with a sleeve which – from its colour and size designation – make it simple to access the right bit quickly.

| | |
|-------------|---------------------------------------|
| 05057684001 | |
| ● ○ | 897/4 1 x 1/4"x75 |
| | Impaktor R |
| + | 855/1 IMP DC 7 x PZ 2x25; 2 x PZ 3x25 |

Bit-Check 10 TX Impaktor 1



1 Impaktor holder with retaining ring and ring magnet in the chuck for a secure fit of the bits in the holder, 9 Impaktor bits. The “Take it easy” Bit-Checks have bits with a sleeve which – from its colour and size designation – make it simple to access the right bit quickly.

| | |
|-------------|---|
| 05057688001 | |
| ● ○ | 897/4 1 x 1/4"x75 |
| | Impaktor R |
| + | 867/1 IMP DC 3 x TX 20x25; 3 x TX 25x25; 2 x TX 30x25; 1 x TX 40x25 |

Tip



Impaktor-Bits



Impact-Bits are needed when a strong power tool (e.g. 18 volt impact screwdriver) is used. Impact bits were specifically developed to withstand high power tool forces.

The Impaktor stainless steel holder with a retaining ring and magnet



The Impaktor stainless steel holder with a retaining ring and magnet satisfies the extreme, dynamic requirements in that there are consciously no small mechanical component parts fitted as they would be more susceptible to failure. It focuses on the basic bit holding function and the cushioning of the extreme impulse peaks with its two different torsion zones. Mainly used in industrial screw assembly applications e.g. with screwdriving robots.

The Impaktor holder with ring magnet



The Impaktor holder with ring magnet additionally holds longer and heavier screws absolutely securely. This enables a speedy and dependable positioning of the screw. It is also ideal for above-head work. Should the magnet function not be required in a particular situation e.g. when working with metal, it can be extracted from the screwdriving area and can thereby be “disabled”. Mainly used in manual power tool applications.



Bit-Checks Impaktor

For an above-average service life

Bit-Check 6 Impaktor 1



6 Impaktor bits.

The "Take it easy" Bit-Checks have bits with a sleeve which – from its colour and size designation – make it simple to access the right bit quickly.

| | |
|-------------|---|
| 05057695001 | |
| + | 851/4 IMP DC 1 x PH 2x50; 1 x PH 3x50 |
| + | 855/4 IMP DC 1 x PZ 2x50; 1 x PZ 3x50 |
| + | 867/4 IMP DC 1 x TX 25x50; 1 x TX 30x50 |

Bit-Check 6 PH Impaktor 1



6 Impaktor bits.

The "Take it easy" Bit-Checks have bits with a sleeve which – from its colour and size designation – make it simple to access the right bit quickly.

| | |
|-------------|---------------------------------------|
| 05057691001 | |
| + | 851/4 IMP DC 4 x PH 2x50; 2 x PH 3x50 |

Bit-Check 6 Impaktor 1 SB

| | |
|-------------|--|
| | |
| 05073890001 | 4013288 158635 |
| + | 851/4 IMP DC 1 x PH 2x50; 1 x PH 3x50 |
| + | 855/4 IMP DC 1 x PZ 2x50; 1 x PZ 3x50 |
| + | 867/4 IMP DC 1 x TX 25x50; 1 x TX 30x50 |



Bit-Check 6 PZ Impaktor 1



6 Impaktor bits.

The "Take it easy" Bit-Checks have bits with a sleeve which – from its colour and size designation – make it simple to access the right bit quickly.

| | |
|-------------|---------------------------------------|
| 05057692001 | |
| + | 855/4 IMP DC 4 x PZ 2x50; 2 x PZ 3x50 |

Bit-Check 6 Impaktor 2



6 Impaktor bits.

The "Take it easy" Bit-Checks have bits with a sleeve which – from its colour and size designation – make it simple to access the right bit quickly.

| | |
|-------------|---|
| 05057694001 | |
| + | 851/4 IMP DC 1 x PH 2x50; 1 x PH 3x50 |
| + | 867/4 IMP DC 1 x TX 25x50; 1 x TX 30x50 |
| + | 868/4 IMP DC 1 x # 2x50; 1 x # 3x50 |

Bit-Check 6 TX Impaktor 1



6 Impaktor bits.

The "Take it easy" Bit-Checks have bits with a sleeve which – from its colour and size designation – make it simple to access the right bit quickly.

| | |
|-------------|---|
| 05057693001 | |
| + | 867/4 IMP DC 2 x TX 20x50; 2 x TX 25x50; 1 x TX 30x50; 1 x TX 40x50 |



” To learn more about this product, scan the QR code. “



Bit-Checks Stainless

Keep rust at bay

Bit-Check 30 Stainless 1



1 Rapidaptor stainless steel bit holder with quick-release chuck, 29 stainless steel bits.

The "Take it easy" Bit-Checks have bits with a sleeve which – from its colour and size designation – make it simple to access the right bit quickly.

| | |
|-------------|--|
| 05071109001 | |
| ●○ | 3888/4/1 K 1 x 1/4"x50 |
| ⊕ | 3851/1 TS PH 1 x PH 1x25; 3 x PH 2x25; 1 x PH 3x25 |
| ⊕ | 3855/1 TS PZ 2 x PZ 1x25; 3 x PZ 2x25; 1 x PZ 3x25 |
| ⊕ | 3867/1 TS 2 x TX 10x25; 2 x TX 15x25; 3 x TX 20x25; TORX® 3 x TX 25x25; 2 x TX 30x25; 1 x TX 40x25 |
| ○ | 3840/1 TS 1 x 2,5x25; 1 x 3,0x25; 1 x 4,0x25; 1 x 5,0x25; 1 x 5,5x25 |

Bit-Check 10 Stainless 1



1 Rapidaptor stainless steel bit holder with quick-release chuck, 9 stainless steel bits.

The "Take it easy" Bit-Checks have bits with a sleeve which – from its colour and size designation – make it simple to access the right bit quickly.

| | |
|-------------|--|
| 05071110001 | |
| ●○ | 3888/4/1 K 1 x 1/4"x50 |
| ⊕ | 3851/1 TS PH 1 x PH 2x25 |
| ⊕ | 3855/1 TS PZ 1 x PZ 1x25; 2 x PZ 2x25 |
| ⊕ | 3867/1 TS 1 x TX 10x25; 1 x TX 15x25; 1 x TX 20x25; TORX® 1 x TX 25x25; 1 x TX 30x25 |

Bit-Check 12 Stainless 1



1 Rapidaptor stainless steel bit holder with quick-release chuck, 11 stainless steel bits.

The "Take it easy" Bit-Checks have bits with a sleeve which – from its colour and size designation – make it simple to access the right bit quickly.

| | |
|-------------|--|
| 05057425001 | |
| ●○ | 3888/4/1 K 1 x 1/4"x50 |
| ⊕ | 3851/1 TS PH 1 x PH 1x25; 1 x PH 2x25 |
| ⊕ | 3855/1 TS PZ 1 x PZ 1x25; 1 x PZ 2x25 |
| ⊕ | 3867/1 TS 1 x TX 15x25; 1 x TX 20x25; 1 x TX 25x25; TORX® 1 x TX 30x25 |
| ○ | 3840/1 TS 1 x 3,0x25; 1 x 4,0x25; 1 x 5,0x25 |

Bit-Check 10 Stainless 1 SB

| | |
|-------------|--|
| 05073630001 | 4013288 112163 |
| ●○ | 3888/4/1 K 1 x 1/4"x50 |
| ⊕ | 3851/1 TS PH 1 x PH 2x25 |
| ⊕ | 3855/1 TS PZ 1 x PZ 1x25; 2 x PZ 2x25 |
| ⊕ | 3867/1 TS TORX® 1 x TX 10x25; 1 x TX 15x25; 1 x TX 20x25; 1 x TX 25x25; 1 x TX 30x25 |



Bit-Check 6 Stainless 1 SB



6 stainless steel bits.

The "Take it easy" Bit-Checks have bits with a sleeve which – from its colour and size designation – make it simple to access the right bit quickly.

| | | | |
|-------------|-----------------|------------------------------|---------|
| | | | 4013288 |
| 05073634001 | 3855/4 | ⊕ 2 x PZ 2x50 | 164636 |
| | 3867/4 TORX® | ⊛ 1 x TX 20x50; 2 x TX 25x50 | |
| | 3840/4 Hex-Plus | ⊙ 1 x 5.5x50 | |

Tip



Stainless Steel Bits



The stainless steel tools from Wera are vacuum ice-hardened and have the hardness and strength needed for screw connections. There are no limitations to the industrial applications they are suitable for.



"Take it easy"

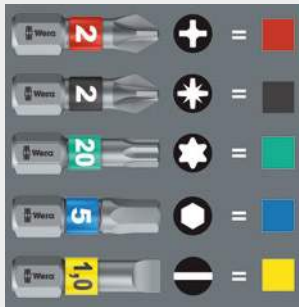

"Take it easy" tool finder with colour coding according to profiles and size stamp – for simple and rapid accessing of the required tool.



Rapidaptor holder out of stainless steel



Manufactured out of stainless steel thus preventing the formation of unsightly extraneous rust when working with stainless steel. Additionally, it offers all the advantages of the Rapidaptor technology.



Bit-Checks / Bit-Safes BiTorsion

BiTorsion – Distinct extension of service life

Bit-Safe 61 BiTorsion 1



1 bit holder Rapidaptor with quick-release chuck, 49 BiTorsion bits for long service life, diamond-coated (BDC) for secure screw fit, tough (BTZ), for universal use, extra-hard (BTH).

The "Take it easy" Bit-Checks have bits with a sleeve which – from its colour and size designation – make it simple to access the right bit quickly.

| | |
|-------------|--|
| | |
| 05057441001 | |
| ⊙ ⊙ | 889/4/1 K 1 x 1/4"x50 |
| ⊕ | 851/1 BDC PH 1 x PH 1x25; 2 x PH 2x25; 1 x PH 3x25 |
| ⊕ | 851/1 BTZ PH 2 x PH 1x25; 8 x PH 2x25; 1 x PH 3x25 |
| ⊕ | 855/1 BDC PZ 1 x PZ 1x25; 2 x PZ 2x25; 1 x PZ 3x25 |
| ⊕ | 855/1 BTH PZ 2 x PZ 1x25; 8 x PZ 2x25; 1 x PZ 3x25 |
| ⊕ | 867/1 TORX® 3 x TX 10x25; 2 x TX 15x25; 4 x TX 20x25; BTZ 4 x TX 25x25; 2 x TX 30x25; 1 x TX 40x25 |
| ⊖ | 800/1 BDC 1 x 0,8x5,5x25; 1 x 1,0x5,5x25; 1 x 1,2x6,5x25 |
| ⊙ | 840/1 BTZ Hex-Plus 3 x 2,5x25; 3 x 3,0x25; 3 x 4,0x25; 2 x 5,0x25 |

Bit-Check 30 BiTorsion 1



1 bit holder Rapidaptor with quick-release chuck, 29 BiTorsion bits for long service life, tough, for universal use.

The "Take it easy" Bit-Checks have bits with a sleeve which – from its colour and size designation – make it simple to access the right bit quickly.

| | |
|-------------|--|
| | |
| 05057430001 | |
| ⊙ ⊙ | 889/4/1 K 1 x 1/4"x50 |
| ⊕ | 851/1 BTZ PH 2 x PH 1x25; 5 x PH 2x25; 2 x PH 3x25 |
| ⊕ | 855/1 BTZ PZ 2 x PZ 1x25; 6 x PZ 2x25; 2 x PZ 3x25 |
| ⊕ | 867/1 TORX® 1 x TX 10x25; 2 x TX 15x25; 2 x TX 20x25; BTZ 2 x TX 25x25; 2 x TX 30x25; 1 x TX 40x25 |

Bit-Check 12 BiTorsion 1



1 bit holder Rapidaptor with quick-release chuck, 11 BiTorsion bits for long service life, tough, for universal use.

The "Take it easy" Bit-Checks have bits with a sleeve which – from its colour and size designation – make it simple to access the right bit quickly.

| | |
|-------------|--|
| | |
| 05057420001 | |
| ⊙ ⊙ | 889/4/1 K 1 x 1/4"x50 |
| ⊕ | 851/1 BTZ PH 1 x PH 1x25; 2 x PH 2x25 |
| ⊕ | 855/1 BTZ PZ 1 x PZ 1x25; 2 x PZ 2x25 |
| ⊕ | 867/1 TORX® 1 x TX 10x25; 1 x TX 15x25; 1 x TX 20x25; BTZ 1 x TX 25x25; 1 x TX 30x25 |

Bit-Check 10 BiTorsion 1



1 BiTorsion bit holder Rapidaptor with quick-release chuck, 9 BiTorsion bits for long service life, tough, for universal use. The "Take it easy" Bit-Checks have bits with a sleeve which – from its colour and size designation – make it simple to access the right bit quickly.

| | |
|-------------|--|
| 05056374001 | |
| ●○ | 897/4 R 1 x 1/4"x75 |
| ⊕ | 851/1 BTZ PH 1 x PH 1x25; 1 x PH 2x25; 1 x PH 3x25 |
| ⊕ | 855/1 BTZ PZ 1 x PZ 1x25; 1 x PZ 2x25; 1 x PZ 3x25 |
| ● | 800/1 BTZ 1 x 0,8x5,5x25; 1 x 1,0x5,5x25; 1 x 1,2x6,5x25 |

Bit-Check 10 BiTorsion 2



1 BiTorsion bit holder Rapidaptor with quick-release chuck, 9 BiTorsion bits for long service life, tough, for universal use. The "Take it easy" Bit-Checks have bits with a sleeve which – from its colour and size designation – make it simple to access the right bit quickly.

| | |
|-------------|--|
| 05057117001 | |
| ●○ | 897/4 R 1 x 1/4"x75 |
| ⊕ | 851/1 BTZ PH 1 x PH 2x25 |
| ⊕ | 855/1 BTZ PZ 1 x PZ 1x25; 2 x PZ 2x25 |
| ⊕ | 867/1 TORX® 1 x TX 10x25; 1 x TX 15x25; 1 x TX 20x25; 1 x TX 25x25; 1 x TX 30x25 |

Tip



BiTorsion

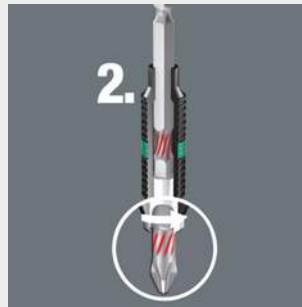

The effectiveness of the BiTorsion system comes from a combination of two shock-absorbing spring elements.

Both bits as well as holders have a cushioning torsion zone that diverts the kinetic energy away from the drive tip during peak loads.



BDC-Bits



BDC-Bits are absolutely premium products. They have a softer BiTorsion zone which reduces the hardness of the shaft by about 20 % in comparison to the drive tip. This means that the peak loads that cause bit breakage and premature wear are absorbed in this zone – something which enhances the service life of the bits.

The diamond coating lowers the danger of slipping as the minute diamond particles literally "bite" themselves into the screw head. B stands for BiTorsion. DC stands for diamond coated.



"Take it easy"

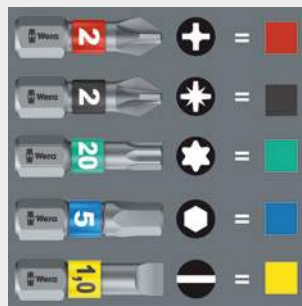

"Take it easy" tool finder with colour coding according to profiles and size stamp – for simple and rapid accessing of the required tool.



Bit-Checks / Bit-Safes BiTorsion

BiTorsion – Distinct extension of service life

Bit-Check 10 BiTorsion 3 SB



1 BiTorsion bit holder Rapidaptor with quick-release chuck, 9 BiTorsion bits for long service life, tough, for universal use. The “Take it easy” Bit-Checks have bits with a sleeve which – from its colour and size designation – make it simple to access the right bit quickly.

| | | | |
|-------------|-----------------|--|---------|
| | | | 4013288 |
| 05073418001 | 897/4 R | ●○ 1 x 1/4"x75 | 128157 |
| | 851/1 BTZ PH | ⊕ 1 x PH 2x25 | |
| | 855/1 BTZ PZ | ⊕ 1 x PZ 1x25; 1 x PZ 2x25; 1 x PZ 3x25 | |
| | 867/1 TORX® BTZ | ⊕ 1 x TX 10x25; 1 x TX 15x25; 1 x TX 20x25; 1 x TX 25x25; 1 x TX 30x25 | |

Bit-Check 10 PZ BiTorsion 1



1 BiTorsion bit holder Rapidaptor with quick-release chuck, 9 BiTorsion bits for long service life, tough, for universal use. The “Take it easy” Bit-Checks have bits with a sleeve which – from its colour and size designation – make it simple to access the right bit quickly.

| | | | |
|-------------|----------------|--------------------------|--|
| 05056368001 | | | |
| | ●○ 897/4 R | 1 x 1/4"x75 | |
| | ⊕ 855/1 BTZ PZ | 7 x PZ 2x25; 2 x PZ 3x25 | |

Bit-Check 10 PZ BiTorsion 2



1 BiTorsion bit holder Rapidaptor with quick-release chuck, 9 BiTorsion bits for long service life, extra-hard. The “Take it easy” Bit-Checks have bits with a sleeve which – from its colour and size designation – make it simple to access the right bit quickly.

| | | | |
|-------------|----------------|---------------------------------------|--|
| 05347153001 | | | |
| | ●○ 897/4 R | 1 x 1/4"x75 | |
| | ⊕ 855/1 BTH PZ | 1 x PZ 1x25; 7 x PZ 2x25; 1 x PZ 3x25 | |

Bit-Check 7 PZ BiTorsion 1



1 bit holder Rapidaptor with quick-release chuck suitable, 6 BiTorsion bits for long service life, extra-hard. The “Take it easy” Bit-Checks have bits with a sleeve which – from its colour and size designation – make it simple to access the right bit quickly.

| | | | |
|-------------|----------------|---------------------------------------|--|
| 05340260001 | | | |
| | ●○ 889/4/1 K | 1 x 1/4"x50 | |
| | ⊕ 855/1 BTH PZ | 1 x PZ 1x25; 4 x PZ 2x25; 1 x PZ 3x25 | |

Bit-Check 7 PH BiTorsion 1



1 universal bit holder with stainless steel sleeve and strong permanent magnet, 6 BiTorsion bits for long service life, extra-hard. The "Take it easy" Bit-Checks have bits with a sleeve which – from its colour and size designation – make it simple to access the right bit quickly.

| | |
|-------------|--------------------------|
| 05056291001 | |
| ● ○ | 893/4/1 K 1 x 1/4"x50 |
| ⊕ | 851/1 BTH PH 6 x PH 2x25 |

Bit-Check 6 PH BiTorsion 1



6 BiTorsion bits for long service life, extra-hard. The "Take it easy" Bit-Checks have bits with a sleeve which – from its colour and size designation – make it simple to access the right bit quickly.

| | |
|-------------|--------------------------|
| 05056477001 | |
| ⊕ | 851/4 BTH PH 6 x PH 2x50 |

Tip



BiTorsion



The BiTorsion holder and the Bi-Torsion bit can, of course, be used independently of one another.

Chuck-all



The Rapidaptor quick-release chucks hold both 1/4" bits as per DIN ISO 1173-C 6,3 (Wera series 1) and E 6,3 (Wera series 4).

Rapid-in and self-lock

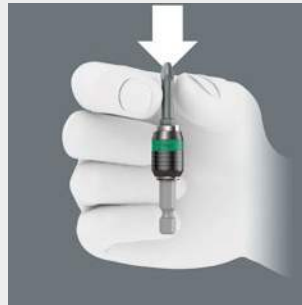

The bit can be pushed into the chuck without moving the sleeve. It automatically locks with a secure and wobble-free fit as soon as the bit is applied to the screw.

Rapid-out



Simply push the sleeve forward to change the bit. The spring mechanism lifts the bit off the magnet and unlocks the tool. The bit can be easily removed. Particularly helpful: even the smallest bits can be removed without any extra tools.



Bit-Checks Diamond

Bits with "bite"

Bit-Check 30 Diamond 1



1 bit holder Rapidaptor with quick-release chuck, 29 BiTorsion bits for long service life, diamond-coated (BDC) for secure screw fit. The "Take it easy" Bit-Checks have bits with a sleeve which – from its colour and size designation – make it simple to access the right bit quickly.

| | |
|-------------|--|
| 05057431001 | |
| ● ○ | 889/4/1 K 1 x 1/4"x50 |
| + | 851/1 BDC PH 2 x PH 1x25; 4 x PH 2x25; 1 x PH 3x25 |
| + | 855/1 BDC PZ 2 x PZ 1x25; 4 x PZ 2x25; 1 x PZ 3x25 |
| + | 867/1 TORX® 2 x TX 10x25; 2 x TX 15x25; 3 x TX 20x25; 3 x TX 25x25; 1 x TX 30x25; 1 x TX 40x25 |
| ● | 800/1 BDC 1 x 0,8x5,5x25; 1 x 1,0x5,5x25; 1 x 1,2x6,5x25 |

Bit-Check 10 Diamond 1



1 BiTorsion bit holder Rapidaptor with quick-release chuck, 9 BiTorsion bits for long service life, diamond-coated (BDC) for secure screw fit. The "Take it easy" Bit-Checks have bits with a sleeve which – from its colour and size designation – make it simple to access the right bit quickly.

| | |
|-------------|--|
| 05057116001 | |
| ● ○ | 897/4 R 1 x 1/4"x75 |
| + | 851/1 BDC PH 1 x PH 2x25 |
| + | 855/1 BDC PZ 1 x PZ 1x25; 2 x PZ 2x25 |
| + | 867/1 TORX® 1 x TX 10x25; 1 x TX 15x25; 1 x TX 20x25; BDC 1 x TX 25x25; 1 x TX 30x25 |

Bit-Check 12 Diamond 1



1 bit holder Rapidaptor with quick-release chuck, 11 BiTorsion bits for long service life, diamond-coated (BDC) for secure screw fit. The "Take it easy" Bit-Checks have bits with a sleeve which – from its colour and size designation – make it simple to access the right bit quickly.

| | |
|-------------|--|
| 05057421001 | |
| ● ○ | 889/4/1 K 1 x 1/4"x50 |
| + | 851/1 BDC PH 1 x PH 1x25; 2 x PH 2x25 |
| + | 855/1 BDC PZ 1 x PZ 1x25; 2 x PZ 2x25 |
| + | 867/1 TORX® 1 x TX 10x25; 1 x TX 15x25; 1 x TX 20x25; BDC 1 x TX 25x25; 1 x TX 30x25 |

Bit-Check 7 Diamond 1



1 bit holder Rapidaptor with quick-release chuck, 6 BiTorsion bits for long service life, diamond-coated (BDC) for secure screw fit. The "Take it easy" Bit-Checks have bits with a sleeve which – from its colour and size designation – make it simple to access the right bit quickly.

| | |
|-------------|--|
| 05057416001 | |
| ⊙ | 889/4/1 K 1 x 1/4"x50 |
| + | 851/1 BDC PH 1 x PH 1x25; 1 x PH 2x25 |
| + | 855/1 BDC PZ 1 x PZ 1x25; 1 x PZ 2x25 |
| ⊖ | 800/1 BDC 1 x 1,0x5,5x25; 1 x 1,2x6,5x25 |

Bit-Check 7 Diamond 1 SB

| | |
|-------------|--|
| | 4013288 |
| 05073419001 | 183682 |
| ⊙ | 889/4/1 K 1 x 1/4"x50 |
| + | 851/1 BDC PH 1 x PH 1x25; 1 x PH 2x25 |
| + | 855/1 BDC PZ 1 x PZ 1x25; 1 x PZ 2x25 |
| ⊖ | 800/1 BDC 1 x 1.0x5.5x25; 1 x 1.2x6.5x25 |



Tip



BDC-Bits



BDC-Bits are absolutely premium products. They have a softer BiTorsion zone which reduces the hardness of the shaft by about 20 % in comparison to the drive tip. This means that the peak loads that cause bit breakage and premature wear are absorbed in this zone – something which enhances the service life of the bits. The diamond coating lowers the danger of slipping as the minute diamond particles literally "bite" themselves into the screw head. B stands for BiTorsion. DC stands for diamond coated.



"Take it easy"

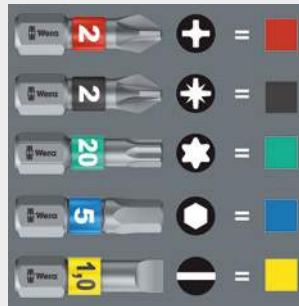

"Take it easy" tool finder with colour coding according to profiles and size stamp – for simple and rapid accessing of the required tool.



BiTorsion Rapidaptor



BiTorsion bit holders are suitable for all bits in accordance with C 6,3 and E 6,3. The optimally coordinated features of the torsion zones on the BiTorsion bits and BiTorsion holder permit a phased yield when under strain. This two-phase system prevents premature wear. The bits and the holder can be used independently of one another. A long tool service life is guaranteed when both elements are used.



Bit-Checks Diamond

Bits with "bite"

Bit-Check 7 PZ Diamond 1



1 bit holder Rapidaptor with quick-release chuck, 6 BiTorsion bits for long service life, diamond-coated (BDC) for secure screw fit. The "Take it easy" Bit-Checks have bits with a sleeve which – from its colour and size designation – make it simple to access the right bit quickly.

| | |
|-------------|--|
| 05057412001 | |
| ● ○ | 889/4/1 K 1 x 1/4"x50 |
| ⊕ | 855/1 BDC PZ 2 x PZ 1x25; 3 x PZ 2x25; 1 x PZ 3x25 |

Bit-Check 7 PH Diamond 1



1 bit holder Rapidaptor with quick-release chuck, 6 BiTorsion bits for long service life, diamond-coated (BDC) for secure screw fit. The "Take it easy" Bit-Checks have bits with a sleeve which – from its colour and size designation – make it simple to access the right bit quickly.

| | |
|-------------|--|
| 05057414001 | |
| ● ○ | 889/4/1 K 1 x 1/4"x50 |
| ⊕ | 851/1 BDC PH 2 x PH 1x25; 3 x PH 2x25; 1 x PH 3x25 |

Bit-Check 7 PZ Diamond 1 SB

| | | |
|-------------|--|-------------------|
| 05073534001 | | 4013288 180940 |
| ● ○ | 889/4/1 K 1 x 1/4"x50 | |
| ⊕ | 855/1 BDC PZ 2 x PZ 1x25; 3 x PZ 2x25; 1 x PZ 3x25 | |



Bit-Check 7 TX Diamond 1



1 bit holder Rapidaptor with quick-release chuck, 6 BiTorsion bits for long service life, diamond-coated (BDC) for secure screw fit. The "Take it easy" Bit-Checks have bits with a sleeve which – from its colour and size designation – make it simple to access the right bit quickly.

| | |
|-------------|--|
| 05057415001 | |
| ● ○ | 889/4/1 K 1 x 1/4"x50 |
| ⊕ | 867/1 TORX® BDC 1 x TX 10x25; 1 x TX 15x25; 1 x TX 20x25; 1 x TX 25x25; 1 x TX 30x25; 1 x TX 40x25 |

Bit-Check 6 PH Diamond 1



6 Bitorsion bits for long service life, diamond-coated (BDC) for secure screw fit. The “Take it easy” Bit-Checks have bits with a sleeve which – from its colour and size designation – make it simple to access the right bit quickly.

| |
|--|
| 05057404001 |
| 851/4 BDC PH 2 x PH 1x50; 3 x PH 2x50; 1 x PH 3x50 |

Bit-Check 6 PZ Diamond 1



6 Bitorsion bits for long service life, diamond-coated (BDC) for secure screw fit. The “Take it easy” Bit-Checks have bits with a sleeve which – from its colour and size designation – make it simple to access the right bit quickly.

| |
|--|
| 05057402001 |
| 855/4 BDC PZ 2 x PZ 1x50; 3 x PZ 2x50; 1 x PZ 3x50 |

Tip

Chuck-all



The Rapidaptor quick-release chucks hold both ¼" bits as per DIN ISO 1173-C 6,3 (Wera series 1) and E 6,3 (Wera series 4).

Single-hand



All functions of the quick-release chuck such as the inserting or releasing of bits can be done with just one hand. That is faster, more economic and ergonomic. There are no unnecessary manoeuvres.

Rapid-in and self-lock



The bit can be pushed into the chuck without moving the sleeve. It automatically locks with a secure and wobble-free fit as soon as the bit is applied to the screw.

Rapid-out



Simply push the sleeve forward to change the bit. The spring mechanism lifts the bit off the magnet and unlocks the tool. The bit can be easily removed. Particularly helpful: even the smallest bits can be removed without any extra tools.

Rapid-spin



The free-turning sleeve allows screw steadying at the start of the screwdriving process. This makes it easier to apply the tool to the screw and prevents slipping. It can also be used as a short extension for ¼" applications e.g. in combination with the Wera Zyklop Ratchets.



Bit-Checks / Bit-Safes Universal

For general use

Bit-Safe 61 Universal 1



1 bit holder Rapidaptor with strong permanent magnet and quick-release chuck, 60 bits, Torsion-style (T) design to reduce premature wear, tough (Z), for universal use.

| | |
|-------------|---|
| 05057122001 | |
| ●○ | 889/4/1 K 1 x 1/4"x50 |
| + | 851/1 TZ PH 3 x PH 1x25; 10 x PH 2x25; 2 x PH 3x25 |
| + | 855/1 TZ PZ 3 x PZ 1x25; 10 x PZ 2x25; 2 x PZ 3x25 |
| + | 867/1 TZ TORX® 2 x TX 10x25; 3 x TX 15x25; 3 x TX 20x25; 3 x TX 25x25; 3 x TX 30x25; 2 x TX 40x25 |
| ● | 800/1 TZ 1 x 0,6x4,5x25; 1 x 1,0x5,5x25; 1 x 1,2x6,5x25 |
| ○ | 840/1 Z Hex-Plus 3 x 2,5x25; 3 x 3,0x25; 3 x 4,0x25; 2 x 5,0x25 |

Bit-Safe 61 Universal 2



1 universal bit holder with stainless steel sleeve, retaining ring, and strong permanent magnet, 60 bits, tough, for universal use.

| | |
|-------------|--|
| 05057455001 | |
| ●○ | 889/4/1 1 x 899/4/1 Kx1/4"x50 |
| + | 851/1 Z PH 10 x PH 1x25; 20 x PH 2x25; 5 x PH 3x25 |
| + | 855/1 Z PZ 3 x PZ 2x25 |
| + | 867/1 TORX® 3 x TX 10x25; 5 x TX 15x25; 5 x TX 20x25; 5 x TX 25x25; 2 x TX 30x25; 2 x TX 40x25 |

Bit-Safe 43 Universal 1



1 universal bit holder with stainless steel sleeve, retaining ring, and strong permanent magnet, 42 bits, Torsion-style (T) design to reduce premature wear, tough, for universal use.

| | |
|-------------|--|
| 05057450001 | |
| ●○ | 889/4/1 1 x 899/4/1 Kx1/4"x50 |
| + | 851/1 Z PH 1 x PH 2x25 |
| + | 851/4 TZ PH 1 x PH1x50; 2 x PH2x50 |
| + | 855/1 Z PZ 2 x PZ 1x25; 5 x PZ 2x25; 2 x PZ 3x25 |
| + | 855/4 TZ PZ 1 x PZ 1x50; 2 x PZ 2x50 |
| + | 867/1 TORX® 3 x TX 10x25; 4 x TX 15x25; 4 x TX 20x25; 4 x TX 25x25; 4 x TX 30x25; 1 x TX 40x25 |
| + | 867/4 Z TORX® 1 x TX 10x50; 1 x TX 15x50; 1 x TX 20x50; 1 x TX 25x50; 1 x TX 30x50; 1 x TX 40x50 |

Bit-Check 30 Universal 1



1 bit holder Rapidaptor with quick-release chuck, 29 bits, Torsion-style (T) design to reduce premature wear, tough (Z), for universal use, extra-hard (H).

| | |
|-------------|---|
| 05056440001 | |
| ●○ | 889/4/1 K 1 x 1/4"x50 |
| + | 851/1 TZ PH 2 x PH 1x25; 3 x PH 2x25; 1 x PH 3x25 |
| + | 855/1 TH PZ 2 x PZ 1x25; 3 x PZ 2x25; 1 x PZ 3x25 |
| + | 867/1 TZ TORX® 1 x TX 10x25; 1 x TX 15x25; 1 x TX 20x25; 1 x TX 25x25; 1 x TX 30x25; 1 x TX 40x25 |
| + | 867/1 Z TORX® 1 x TX 10x25; 1 x TX 15x25; 1 x TX 20x25; BO 1 x TX 25x25; 1 x TX 30x25 |
| ● | 800/1 TZ 1 x 1,0x5,5x25 |
| ○ | 840/1 Z Hex-Plus 1 x 3,0x25; 1 x 4,0x25; 1 x 5,0x25; 1 x 6,0x25; 1 x 8,0x25 |

Bit-Check 30 TX Universal 1



1 universal bit holder with stainless steel sleeve, retaining ring, and strong permanent magnet, 29 bits, tough, for universal use.

| | |
|-------------|--|
| 05057908001 | |
| ●○ | 899/4/1 1 x 899/4/1 Kx1/4"x50 |
| ⊕ | 867/1 TORX® 3 x TX 10x25; 5 x TX 15x25; 8 x TX 20x25; 7 x TX 25x25; 4 x TX 30x25; 2 x TX 40x25 |

Bit-Check 12 Universal 1



1 bit holder Rapidaptor with quick-release chuck, 11 bits, tough, for universal use, 851/1 A extra-hard, profiled version, 868/1 V with holding function.

| | |
|-------------|---|
| 05057428001 | |
| ●○ | 888/4/1 K 1 x 1/4"x50 |
| ⊕ | 851/1 A PH 1 x PH 1x25; 2 x PH 2x25; 1 x PH 3x25 |
| ⊕ | 867/1 TORX® 1 x TX 8x25; 1 x TX 20x25; 1 x TX 25x25 |
| ○ | 868/1 V 1 x # 1x25; 2 x # 2x25; 1 x # 3x25 |

Bit-Check 12 Universal 2



1 magnetic Rapidaptor quick-release bit holder with ringmagnet, 11 bits, tough, for universal use, 851/1 A extra-hard, profiled version, 868/1 V with holding function.

| | |
|-------------|--|
| 05057429001 | |
| ●○ | 887/4 RR 1 x 1/4"x57 |
| ⊕ | 851/1 A PH 1 x PH 1x25; 2 x PH 2x25; 1 x PH 3x25 |
| ● | 800/1 Z 1 x 0,8x5,5x25; 1 x 1,0x5,5x25; 1 x 1,2x6,5x25 |
| ○ | 868/1 V 1 x # 1x25; 2 x # 2x25; 1 x # 3x25 |

Tip



Rapidaptor holder



Rapid bit change without needing any additional tools. One-hand operation with a freely spinning sleeve for simplified guidance of the tool.



Hex-Plus



Hexagon screws can endure a problem because the contact surfaces delivering the power from the conventional tool, is transferred to the screw via very small surface areas. The consequence: the screw can become damaged (rounding out). Hex-Plus tools have a greater contact surface that prevents this from happening! Good to know: Hex-Plus tools fit into every standard hexagon socket screw!



Bit-Checks / Bit-Safes Universal

For general use

Bit-Check 10 Universal 1

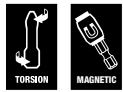

1 bit holder with strong permanent magnet and quick-release chuck, 9 bits, Torsion-style (T) design to reduce premature wear, tough (Z), for universal use.

| | |
|-------------|---|
| 05056161001 | |
| ● ○ | 895/4/1 K 1 x 1/4"x52 |
| + | 851/1 TZ PH 1 x PH 1x25; 1 x PH 2x25; 1 x PH 3x25 |
| + | 855/1 TZ PZ 1 x PZ 1x25; 1 x PZ 2x25; 1 x PZ 3x25 |
| ● | 800/1 TZ 1 x 0,8x5,5x25; 1 x 1,0x5,5x25; 1 x 1,2x6,5x25 |

Bit-Check 10 Universal 3



1 bit holder Rapidaptor with quick-release chuck, 9 bits, Torsion-style (T) design to reduce premature wear, tough (Z), for universal use.

| | |
|-------------|---|
| 05056375001 | |
| ● ○ | 889/4/1 K 1 x 1/4"x50 |
| + | 851/1 TZ PH 1 x PH 1x25; 1 x PH 2x25; 1 x PH 3x25 |
| + | 855/1 TZ PZ 1 x PZ 1x25; 1 x PZ 2x25; 1 x PZ 3x25 |
| ● | 800/1 TZ 1 x 0,8x5,5x25; 1 x 1,0x5,5x25; 1 x 1,2x6,5x25 |

Bit-Check 10 Universal 2



1 bit holder with strong permanent magnet and quick-release chuck, 9 bits, Torsion-style (T) design to reduce premature wear, tough, for universal use, extra-hard (H).

| | |
|-------------|--|
| 05134200001 | |
| ● ○ | 895/4/1 K 1 x 1/4"x52 |
| + | 855/1 TH PZ 1 x PZ 1x25; 2 x PZ 2x25 |
| + | 867/1 TORX® 1 x TX 10x25; 1 x TX 15x25; 1 x TX 20x25; 1 x TX 25x25; 1 x TX 30x25; 1 x TX 40x25 |

Bit-Check 10 Universal 3 SB

| | |
|-------------|---|
| 05073410001 | 4013288 099495 |
| ● ○ | 889/4/1 K 1 x 1/4"x50 |
| ● | 800/1 TZ 1 x 0,8x5,5x25; 1 x 1,0x5,5x25; 1 x 1,2x6,5x25 |
| + | 851/1 TZ PH 1 x PH 1x25; 1 x PH 2x25; 1 x PH 3x25 |
| + | 855/1 TZ PZ 1 x PZ 1x25; 1 x PZ 2x25; 1 x PZ 3x25 |



Bit-Check 10 Universal 4



1 Universal bit holder with stainless steel sleeve, retaining ring, and strong permanent magnet, 9 bits, Torsion-style (T) design to reduce premature wear, tough (Z), for universal use.

| | |
|-------------|---|
| 05056159001 | |
| ● ○ | 899/4/1 1 x 899/4/1 Kx1/4"x50 |
| + | 851/1 TZ PH 1 x PH 1x25; 1 x PH 2x25; 1 x PH 3x25 |
| + | 855/1 TZ PZ 1 x PZ 1x25; 1 x PZ 2x25; 1 x PZ 3x25 |
| ● | 800/1 TZ 1 x 0,8x5,5x25; 1 x 1,0x5,5x25; 1 x 1,2x6,5x25 |

Bit-Check 10 Universal 5 SB



1 Universal bit holder with stainless steel sleeve, retaining ring, and strong permanent magnet, 9 bits, tough, for universal use.

| | | | | |
|-------------|-------------|----|--|-------------------|
| 05073416001 | 899/4/1 | ●○ | 1 x 899/4/1 Kx1/4"x50 | 4013288 128164 |
| | 851/1 Z PH | + | 1 x PH 2x25 | |
| | 855/1 Z PZ | + | 1 x PZ 1x25; 1 x PZ 2x25; 1 x PZ 3x25 | |
| | 867/1 TORX® | ⊖ | 1 x TX 10x25; 1 x TX 15x25; 1 x TX 20x25; 1 x TX 25x25; 1 x TX 30x25 | |

Bit-Check 10 PZ Universal 1



1 bit holder with strong permanent magnet and quick-release chuck, 9 bits, Torsion-style (T) design to reduce premature wear, extra-hard (H).

| | | | | |
|-------------|-------------|----|---------------------------------------|--|
| 05056163001 | | | | |
| | 895/4/1 K | ●○ | 1 x 1/4"x52 | |
| | 855/1 TH PZ | + | 3 x PZ 1x25; 3 x PZ 2x25; 3 x PZ 3x25 | |

Bit-Check 10 PZ Universal 2



1 bit holder Rapidaptor with quick-release chuck, 9 bits, Torsion-style (T) design to reduce premature wear, extra-hard (H).

| | | | | |
|-------------|-------------|----|---------------------------------------|--|
| 05056376001 | | | | |
| | 889/4/1 K | ●○ | 1 x 1/4"x50 | |
| | 855/1 TH PZ | + | 3 x PZ 1x25; 3 x PZ 2x25; 3 x PZ 3x25 | |

Tip

Chuck-all



The Rapidaptor quick-release chucks hold both 1/4" bits as per DIN ISO 1173-C 6,3 (Wera series 1) and E 6,3 (Wera series 4).

Single-hand



All functions of the quick-release chuck such as the inserting or releasing of bits can be done with just one hand. That is faster, more economic and ergonomic. There are no unnecessary manoeuvres.

Rapid-in and self-lock

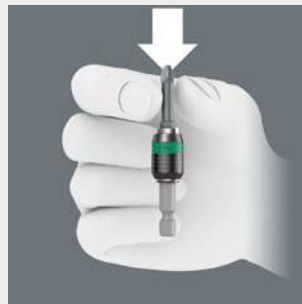

The bit can be pushed into the chuck without moving the sleeve. It automatically locks with a secure and wobble-free fit as soon as the bit is applied to the screw.

Rapid-out



Simply push the sleeve forward to change the bit. The spring mechanism lifts the bit off the magnet and unlocks the tool. The bit can be easily removed. Particularly helpful: even the smallest bits can be removed without any extra tools.

Rapid-spin



The free-turning sleeve allows screw steadying at the start of the screwdriving process. This makes it easier to apply the tool to the screw and prevents slipping. It can also be used as a short extension for 1/4" applications e.g. in combination with the Wera Zyklop Ratchets.



Bit-Checks / Bit-Safes Universal

For general use

Bit-Check 10 TX Universal 1



1 bit holder with quick-release chuck, 9 bits, Torsion-style (T) design to reduce premature wear, tough (Z), for universal use.

| | | |
|-------------|----------------|--|
| 05056164001 | | |
| ●○ | 894/4/1 K | 1 x 1/4"x51 |
| ♻️ | 867/1 TZ TORX® | 1 x TX 8x25; 1 x TX 9x25; 1 x TX 10x25; 1 x TX 15x25; 1 x TX 20x25; 1 x TX 25x25; 1 x TX 27x25; 1 x TX 30x25; 1 x TX 40x25 |

Bit-Check 7 Universal 1



1 universal bit holder with stainless steel sleeve and strong permanent magnet, 6 bits, tough (Z), for universal use.

| | | |
|-------------|------------|--------------------------------|
| 05056295001 | | |
| ●○ | 893/4/1 K | 1 x 1/4"x50 |
| ⊕ | 851/1 Z PH | 1 x PH 1x25; 1 x PH 2x25 |
| ⊕ | 855/1 Z PZ | 1 x PZ 1x25; 1 x PZ 2x25 |
| ● | 800/1 Z | 1 x 1,0x5,5x25; 1 x 1,2x6,5x25 |

Bit-Check 10 TX Universal 2



1 bit holder Rapidaptor with quick-release chuck, 9 bits, tough, for universal use.

| | | |
|-------------|-------------|---|
| 05057115001 | | |
| ●○ | 888/4/1 K | 1 x 1/4"x50 |
| ♻️ | 867/1 TORX® | 1 x TX 6x25; 1 x TX 8x25; 1 x TX 9x25; 1 x TX 10x25; 1 x TX 15x25; 1 x TX 20x25; 1 x TX 25x25; 1 x TX 30x25; 1 x TX 40x25 |

Bit-Check 7 Universal 1 SB

| | | |
|-------------|------------|-----------------------------------|
| | | 4013288 |
| 05073406001 | | 036186 |
| ●○ | 893/4/1 K | 1 x 1/4"x50 |
| ⊕ | 851/1 Z PH | 1 x PH 1x25; 1 x PH 2x25 |
| ⊕ | 855/1 Z PZ | 1 x PZ 1x25; 1 x PZ 2x25 |
| ● | 800/1 Z | 1 x 1.0x5.5x25; 1 x 1.2x6.5x25 |



Bit-Check 7 Universal 2

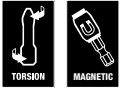

1 bit holder with strong permanent magnet and quick-release chuck, 6 bits, Torsion-style (T) design to reduce premature wear, tough (Z), for universal use.

| | | |
|-------------|-------------|--------------------------------|
| 05056155001 | | |
| ●○ | 893/4/1 K | 1 x 1/4"x52 |
| ⊕ | 851/1 TZ PH | 1 x PH 1x25; 1 x PH 2x25 |
| ⊕ | 855/1 TZ PZ | 1 x PZ 1x25; 1 x PZ 2x25 |
| ● | 800/1 Z | 1 x 1,0x5,5x25; 1 x 1,2x6,5x25 |

Bit-Check 7 PZ Universal 1



1 universal bit holder with stainless steel sleeve and strong permanent magnet, 6 bits, tough (Z), for universal use.

| | | |
|-------------|------------|---------------------------------------|
| 05056296001 | | |
| ●○ | 893/4/1 K | 1 x 1/4"x50 |
| ⊕ | 855/1 Z PZ | 2 x PZ 1x25; 3 x PZ 2x25; 1 x PZ 3x25 |

Bit-Check 7 Universal 3



1 universal bit holder with stainless steel sleeve and strong permanent magnet, 6 bits, tough (Z), for universal use.

| | | |
|-------------|------------|--------------------------------|
| 05340322001 | | |
| ●○ | 893/4/1 K | 1 x 1/4"x50 |
| ⊕ | 851/1 Z PH | 1 x PH 1x25; 1 x PH 2x25 |
| ● | 800/1 Z | 1 x 1,0x5,5x25; 1 x 1,2x6,5x25 |
| ○ | 868/1 Z | 1 x # 1x25; 1 x # 2x25 |

Bit-Check 7 PZ Universal 1 SB

| | | |
|-------------|------------|---------------------------------------|
| 05073536001 | | 4013288 105998 |
| ●○ | 893/4/1 K | 1 x 1/4"x50 |
| ⊕ | 855/1 Z PZ | 2 x PZ 1x25; 3 x PZ 2x25; 1 x PZ 3x25 |



Bit-Check 7 PZ Universal 2



1 bit holder with strong permanent magnet and quick-release chuck, 6 bits, Torsion-style (T) design to reduce premature wear, extra-hard (H).

| | | |
|-------------|-------------|---------------------------------------|
| 05056157001 | | |
| ●○ | 893/4/1 K | 1 x 1/4"x52 |
| ⊕ | 855/1 TH PZ | 2 x PZ 1x25; 3 x PZ 2x25; 1 x PZ 3x25 |

Bit-Check 7 Universal 4



1 universal bit holder with stainless steel sleeve and strong permanent magnet, 6 bits, tough (Z), for universal use.

| | | |
|-------------|-------------|--|
| 05135810001 | | |
| ●○ | 893/4/1 K | 1 x 1/4"x50 |
| ⊕ | 851/1 Z PH | 1 x PH 2x25 |
| ⊕ | 855/1 Z PZ | 1 x PZ 1x25; 1 x PZ 2x25 |
| ⊕ | 867/1 TORX® | 1 x TX 15x25; 1 x TX 20x25; 1 x TX 25x25 |



Bit-Checks / Bit-Safes Universal

For general use

Bit-Check 7 TX Universal 1



1 universal bit holder with stainless steel sleeve and strong permanent magnet, 6 bits, tough, for universal use.

| | |
|-------------|---|
| 05056294001 | |
| ●○ | 893/4/1 K 1 x 1/4"x50 |
| ⊕ | 867/1 TORX® 1 x TX 10x25; 1 x TX 15x25; 1 x TX 20x25; 1 x TX 25x25; 1 x TX 30x25; 1 x TX 40x25 |

Bit-Check 7 Hex-Plus 1



1 bit holder with strong permanent magnet and quick-release chuck, 6 bits, tough (Z), for universal use.

| | |
|-------------|--|
| 05056168001 | |
| ●○ | 895/4/1 K 1 x 1/4"x52 |
| ○ | 840/1 Z 1 x 2,0x25; 1 x 2,5x25; 1 x 3,0x25; 1 x 4,0x25; Hex-Plus 1 x 5,0x25; 1 x 6,0x25 |

Bit-Check 7 TX Universal 1 SB

| | | |
|-------------|--|-------------------|
| 05073404001 | | 4013288 038111 |
| ●○ | 893/4/1 K 1 x 1/4"x50 | |
| ⊕ | 867/1 TORX® 1 x TX 10x25; 1 x TX 15x25; 1 x TX 20x25; 1 x TX 25x25; 1 x TX 30x25; 1 x TX 40x25 | |



Bit-Check 7 TiN Universal 1



1 universal bit holder with stainless steel sleeve and strong permanent magnet, 6 bits, TiN coating for the hardness needed e.g. in series screwdriving operations.

| | |
|-------------|--|
| 05056285001 | |
| ●○ | 893/4/1 K 1 x 1/4"x50 |
| ⊕ | 851/1 TiN PH 1 x PH 1x25; 1 x PH 2x25 |
| ⊕ | 855/1 TiN PZ 1 x PZ 1x25; 1 x PZ 2x25 |
| ● | 800/1 TiN 1 x 0,8x5,5x25; 1 x 1,2x6,5x25 |

Bit-Check 7 TX BO Universal 1



1 bit holder with quick-release chuck, 6 bits, tough (Z), for universal use.

| | |
|-------------|--|
| 05056158001 | |
| ●○ | 894/4/1 K 1 x 1/4"x51 |
| ⊕ | 867/1 Z TORX® 1 x TX 10x25; 1 x TX 15x25; 1 x TX 20x25; BO 1 x TX 25x25; 1 x TX 30x25; 1 x TX 40x25 |

Bit-Check 7 TiN Universal 1 SB

| | | |
|-------------|---|-------------------|
| 05073537001 | | 4013288 106001 |
| ●○ | 893/4/1 K 1 x 1/4"x50 | |
| ⊕ | 851/1 TiN PH 1 x PH 1x25; 1 x PH 2x25 | |
| ⊕ | 855/1 TiN PZ 1 x PZ 1x25; 1 x PZ 2x25 | |
| ● | 800/1 TiN 1 x 0,8x5,5x25; 1 x 1,2x6,5x25 | |



Bit-Check 7 TiN PZ Universal 1 SB



1 universal bit holder with stainless steel sleeve and strong permanent magnet, 6 bits, TiN coating for the hardness needed e.g. in series screwdriving operations.

| | | | |
|-------------|--------------|--|-------------------|
| | | | |
| 05073538001 | 893/4/1 K | 1 x 1/4"x50 | 4013288 106018 |
| | 855/1 TiN PZ | 2 x PZ 1x25; 3 x PZ 2x25; 1 x PZ 3x25 | |

Bit-Check 6 Universal 1



6 bits, Torsion-style (T) design to reduce premature wear, tough (Z), for universal use.

| | | |
|-------------|-------------|--------------------------------|
| 05056474001 | | |
| | 851/4 TZ PH | 1 x PH 1x50; 1 x PH 2x50 |
| | 855/4 TZ PZ | 1 x PZ 1x50; 1 x PZ 2x50 |
| | 800/4 Z | 1 x 1,0x5,5x50; 1 x 1,2x6,5x50 |

Bit-Check 6 Universal 1 SB

| | | |
|-------------|-------------|-----------------------------------|
| | | |
| 05073635001 | | 4013288 155276 |
| | 851/4 TZ PH | 1 x PH 1x50; 1 x PH 2x50 |
| | 855/4 TZ PZ | 1 x PZ 1x50; 1 x PZ 2x50 |
| | 800/4 Z | 1 x 1.0x5.5x50; 1 x 1.2x6.5x50 |



Tip

TiN-Bits



TiN stands for titanium-nitride. An extremely hard coating to withstand permanent loads such as during continual screwdriving operations in series manufacturing.

Universal holder with quick-release chuck



For a firm, wobble-free connection between holder and bit with quick-release action. Simply push sleeve forward to change bits.

Universal holder with stainless steel sleeve



The retaining ring and the strong permanent magnet ensure a particularly secure fitting of the bit in the holder.



Bit-Checks / Bit-Safes Universal

For general use

Bit-Check 6 Universal 2



6 bits, Torsion-style (T) design to reduce premature wear, tough (Z), for universal use.

| | |
|-------------|--|
| 05056473001 | |
| + | 851/4 TZ PH 1 x PH 2x50 |
| + | 855/4 TZ PZ 1 x PZ 1x50; 1 x PZ 2x50 |
| + | 867/4 Z TORX® 1 x TX 15x50; 1 x TX 20x50; 1 x TX 25x50 |

Bit-Check 6 TX Universal 1



6 bits, tough (Z), for universal use.

| | |
|-------------|--|
| 05056472001 | |
| + | 867/4 Z TORX® 1 x TX 10x50; 1 x TX 15x50; 1 x TX 20x50; 1 x TX 25x50; 1 x TX 30x50; 1 x TX 40x50 |

Bit-Check 6 Universal 2 SB

| | | |
|-------------|--|-------------------|
| 05073638001 | | 4013288 155245 |
| + | 851/4 TZ PH 1 x PH 2x50 | |
| + | 855/4 TZ PZ 1 x PZ 1x50; 1 x PZ 2x50 | |
| + | 867/4 Z TORX® 1 x TX 15x50; 1 x TX 20x50; 1 x TX 25x50 | |



Bit-Check 6 TX Universal 1 SB

| | | |
|-------------|--|-------------------|
| 05073637001 | | 4013288 155252 |
| + | 867/4 Z TORX® 1 x TX 10x50; 1 x TX 15x50; 1 x TX 20x50; 1 x TX 25x50; 1 x TX 30x50; 1 x TX 40x50 | |



Bit-Check 6 Universal 3



6 bits, tough (Z), for universal use, 851/4 A extra-hard, profiled version, 868/1 V with holding function.

| | |
|-------------|--|
| 05056479001 | |
| + | 851/4 A PH 1 x PH 1x50; 1 x PH 2x50 |
| + | 867/4 Z TORX® 1 x TX 25x50; 1 x TX 30x50 |
| + | 868/4 V 1 x # 1x50; 1 x # 2x50 |

Bit-Check 6 PZ Universal 1



6 bits, Torsion-style (T) design to reduce premature wear, tough (Z), for universal use.

| | |
|-------------|---|
| 05056471001 | |
| + | 855/4 TZ PZ 2 x PZ 1x50; 3 x PZ 2x50; 1 x PZ 3x50 |

Bit-Check 6 TX HF 1



6 bits, holding function for TORX® socket screws made according to Acument Intellectual Properties specifications.

| | |
|-------------------|---|
| 05056476001 | |
| 867/4 TORX® HF | 1 x TX 10x50; 1 x TX 15x50; 1 x TX 20x50; 1 x TX 25x50; 1 x TX 30x50; 1 x TX 40x50 |

Bit-Check 6 V Universal 1



6 bits, tough (Z), for universal use, with holding function.

| | |
|-------------|------------------------------------|
| 05056478001 | |
| 868/4 V | 1 x # 1x50; 3 x # 2x50; 2 x # 3x50 |

Tip



The HF profile



In tight assembly or disassembly situations, for example in engine compartments, it is not possible to securely hold the screw with the hand on the screwdriver, and the screw subsequently often gets lost. Lengthy searches or the loss of the screw (with the associated danger that could bring about) are the consequence.

The HF tools developed by Wera are ideal because they feature an optimised geometry of the original TORX® profile. The wedging forces resulting from the surface pressure between the drive tip and the screw profile mean that the screw is securely held on the tool!

V bits:

Holding function for Robertson screws

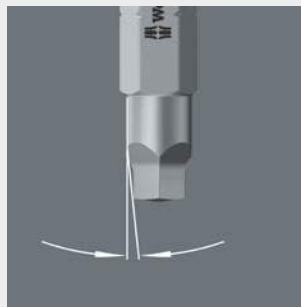

V bits have a conical profile. The clamping forces thus resulting hold Robertson screws securely on the tip of the tool. Ideal for screwdriving at difficult-to-access places.



Bit-Checks Wood

For wood applications

Bit-Safe 61 Wood 1



1 bit holder with strong permanent magnet and quick-release chuck, 60 bits, tough, for universal use.

| | | |
|-------------|-------------|--|
| 05057442001 | | |
| ●○ | 895/4/1 K | 1 x 1/4"x52 |
| + | 851/1 Z PH | 3 x PH 1x25 |
| + | 855/1 Z PZ | 10 x PZ 1x25; 20 x PZ 2x25; 5 x PZ 3x25 |
| ⊕ | 867/1 TORX® | 3 x TX 10x25; 5 x TX 15x25; 5 x TX 20x25; 5 x TX 25x25; 2 x TX 30x25; 2 x TX 40x25 |

Bit-Check 30 Wood 2



1 universal bit holder with stainless steel sleeve, retaining ring, and strong permanent magnet, 29 bits, tough, for universal use.

| | | |
|-------------|-------------|--|
| 05057432001 | | |
| ●○ | 899/4/1 | 1 x 899/4/1 Kx1/4"x50 |
| + | 851/1 Z PH | 1 x PH 2x25 |
| + | 855/1 Z PZ | 2 x PZ 1x25; 5 x PZ 2x25; 2 x PZ 3x25 |
| ⊕ | 867/1 TORX® | 3 x TX 10x25; 4 x TX 15x25; 4 x TX 20x25; 4 x TX 25x25; 3 x TX 30x25; 1 x TX 40x25 |

Bit-Check 30 Wood 1



1 magnetic Rapidaptor quick-release bit holder with ringmagnet, 29 bits, Torsion-style (T) design to reduce premature wear, tough, for universal use, extra-hard (H).

| | | |
|-------------|----------------|--|
| 05057433001 | | |
| ●○ | 887/4 RR | 1 x 1/4"x57 |
| + | 851/1 TZ PH | 2 x PH 2x25; 1 x PH 3x25 |
| + | 855/1 TH PZ | 3 x PZ 1x25; 6 x PZ 2x25; 2 x PZ 3x25 |
| ⊕ | 867/1 TZ TORX® | 2 x TX 10x25; 2 x TX 15x25; 4 x TX 20x25; 4 x TX 25x25; 2 x TX 30x25; 1 x TX 40x25 |

Bit-Check 12 Wood 1



1 magnetic Rapidaptor quick-release bit holder with ringmagnet, 11 bits, Torsion-style (T) design to reduce premature wear, tough, for universal use, extra-hard (H).

| | | |
|-------------|-------------|--|
| 05057423001 | | |
| ●○ | 887/4 RR | 1 x 1/4"x57 |
| + | 855/1 TH PZ | 1 x PZ 1x25; 2 x PZ 2x25; 1 x PZ 3x25 |
| + | 851/1 TH PH | 1 x PH 2x25 |
| ⊕ | 867/1 TORX® | 1 x TX 10x25; 1 x TX 15x25; 1 x TX 20x25; 1 x TX 25x25; 1 x TX 30x25; 1 x TX 40x25 |

Bit-Check 12 Wood 2



1 universal bit holder with stainless steel sleeve, retaining ring, and strong permanent magnet, 11 bits, tough, for universal use.

| | |
|-------------|--|
| 05057422001 | |
| ●○ | 899/4/1 1 x 899/4/1 Kx1/4"x50 |
| + | 851/1 Z PH 1 x PH 2x25 |
| + | 855/1 Z PZ 1 x PZ 1x25; 2 x PZ 2x25; 1 x PZ 3x25 |
| ⊕ | 867/1 TORX® 1 x TX 10x25; 1 x TX 15x25; 1 x TX 20x25; 1 x TX 25x25; 1 x TX 30x25; 1 x TX 40x25 |

Bit-Check 12 Wood 3



1 universal bit holder with stainless steel sleeve and strong permanent magnet, 11 bits, tough, for universal use, 851/1 A extra-hard, profiled version, 868/1 V with holding function.

| | |
|-------------|--|
| 05057426001 | |
| ●○ | 893/4/1 K 1 x 1/4"x50 |
| + | 851/1 A PH 1 x PH 1x25; 1 x PH 2x25; 1 x PH 3x25 |
| ⊕ | 867/1 TORX® 1 x TX 10x25; 1 x TX 15x25; 1 x TX 20x25; 1 x TX 25x25; 1 x TX 30x25; 1 x TX 40x25 |
| ○ | 868/1 V 1 x # 2x25; 1 x # 3x25 |

Bit-Check 12 Wood 4



1 universal bit holder with stainless steel sleeve and strong permanent magnet, 11 bits, extra-hard, profiled version.

| | |
|-------------|--|
| 05057427001 | |
| ●○ | 893/4/1 K 1 x 1/4"x50 |
| + | 851/1 A PH 2 x PH 1x25; 6 x PH 2x25; 3 x PH 3x25 |

Tip



Rapidaptor ring magnet

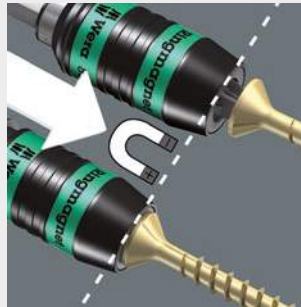

The floating, free-turning sleeve on the Rapidaptor with powerful ring magnet securely holds even large and heavy screws.

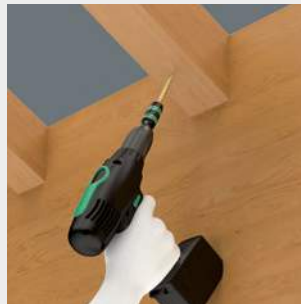

There is no need to hold the screw when applying the tool – something which can be dangerous and painful!

Universal holder with quick-release chuck



For a firm, wobble-free connection between holder and bit with quick-release action. Simply push sleeve forward to change bits.

Universal holder with stainless steel sleeve



The retaining ring and the strong permanent magnet ensure a particularly secure fitting of the bit in the holder.



Bit-Checks Metal

For steel applications

Bit-Check 30 Metal 1



1 universal bit holder with stainless steel sleeve, retaining ring, and strong permanent magnet, 29 bits, tough (Z), for universal use.

| 05057434001 | | |
|-------------|---------------------|---|
| ● ○ | 899/4/1 | 1 x 899/4/1 Kx1/4"x50 |
| + | 851/1 Z PH | 3 x PH 1x25; 3 x PH 2x25; 2 x PH 3x25 |
| + | 855/1 Z PZ | 3 x PZ 1x25; 3 x PZ 2x25; 3 x PZ 3x25 |
| + | 867/1 TORX® | 1 x TX 10x25; 1 x TX 15x25; 1 x TX 20x25; 1 x TX 25x25; 1 x TX 30x25; 1 x TX 40x25 |
| ● | 800/1 Z | 1 x 0,6x4,5x25; 1 x 1,0x5,5x25; 1 x 1,2x6,5x25 |
| ○ | 840/1 Z Hex-Plus | 1 x 4,0x25; 1 x 5,0x25; 1 x 6,0x25 |

Bit-Check 12 Metal 1



1 universal bit holder with stainless steel sleeve, retaining ring, and strong permanent magnet, 11 bits, tough (Z), for universal use.

| 05057424001 | | |
|-------------|---------------------|---|
| ● ○ | 899/4/1 | 1 x 899/4/1 Kx1/4"x50 |
| + | 851/1 Z PH | 1 x PH 1x25; 1 x PH 2x25 |
| + | 855/1 Z PZ | 1 x PZ 1x25; 1 x PZ 2x25 |
| + | 867/1 TORX® | 1 x TX 15x25; 1 x TX 20x25; 1 x TX 25x25; 1 x TX 30x25 |
| ○ | 840/1 Z Hex-Plus | 1 x 3,0x25; 1 x 4,0x25; 1 x 5,0x25 |



Bit Sets for Special Applications

Screwdriving, Drilling, Tapping, Countersinking and Deburring

843 Stepped drill bits, 4-20 mm



Construction: 9 drill steps increasing by 2 mm for material with a max. thickness of 4.5 mm. With edge breaker (sheet metal countersink) at Ø 10 for 1-mm sheet metal

Drive: 1/4" hexagon, suitable for DIN ISO 1173-D 6,3 holders



| |  mm |
|-------------|---|
| 05104672001 | 75,0 |

844/7 Tap Bits Set



7 pieces in robust case

1 universal bit holder 888/4/1 K Rapidaptor, nonmagnetic, suitable for power tools and electronic drills; single tap bits with 1/4" drive, suitable for holders with DIN ISO 1173-D 6,3 receiver.





|  | |
|---|--|
| 05104654001 | |
|  | 888/4/1 K 1 x 1/4"x50 |
|  | 844 1 x 3,0x33,0; 1 x 4,0x35,0; 1 x 5,0x36,0; 1 x 6,0x40,0; 1 x 8,0x40,0; 1 x 10,0x40,0 |

844 Single Tap Bits



Application: For cutting metric threads

Drive: 1/4" hexagon, suitable for DIN ISO 1173-D 6,3 holders

| |  |  |  |  |
|-------------|---|---|---|---|
| | mm | mm | mm | |
| 05104666001 | 3,0 | 10,00 | 33,0 | M 3 |
| 05104667001 | 4,0 | 11,00 | 35,0 | M 4 |
| 05104668001 | 5,0 | 12,50 | 36,0 | M 5 |
| 05104669001 | 6,0 | 18,00 | 40,0 | M 6 |
| 05104670001 | 8,0 | 20,00 | 40,0 | M 8 |
| 05104671001 | 10,0 | 20,00 | 40,0 | M 10 |





845 1-flute Countersink Bits



Application: For countersinking and deburring

Design: 1-flute

Drive: 1/4" hexagon, suitable for DIN ISO 1173-D 6,3 holders

| |  |  |  |  |
|-------------|---|---|---|---|
| | mm | mm | mm | |
| 05104660001 | 6,30 | 21,00 | 32,0 | M 3 |
| 05104661001 | 8,30 | 21,00 | 32,0 | M 4 |
| 05104662001 | 10,40 | 21,00 | 34,0 | M 5 |
| 05104663001 | 12,40 | 21,00 | 36,0 | M 6 |
| 05104664001 | 16,50 | 22,00 | 40,0 | M 8 |
| 05104665001 | 20,50 | 22,00 | 43,0 | M 10 |



Bit Sets for Special Applications





Screwdriving, Drilling, Tapping, Countersinking and Deburring

845/8 1-flute Countersink Bits Set



8 pieces in robust case

1 Kraftform 816 R Rapidaptor quick release bit holder; 1 universal holder 888/4/1 K Rapidaptor, nonmagnetic, suitable for power tools and electronic drills.

|  | | |
|---|------------------|--|
| 05104655001 | | |
|  | 816 R | 1 x 1/4"x119 |
|  | 888/4/1 K | 1 x 1/4"x50 |
|  | 845 | 1 x 6,30x32,0; 1 x 8,30x32,0; 1 x 10,40x34,0; 1 x 12,40x36,0; 1 x 16,50x40,0; 1 x 20,50x43,0 |





847 HSS Combined Tap Bits



Application: Drilling, tapping, deburring

Design: HSS

Drive: 1/4" hexagon, suitable for DIN ISO 1173-D 6,3 holders

| |  |  |  |  |
|-------------|---|---|---|---|
| | mm | mm | mm | |
| 05104640001 | 2,5 | 12,00 | 36,0 | M 3 |
| 05104641001 | 3,3 | 12,00 | 39,0 | M 4 |
| 05104642001 | 4,2 | 12,00 | 41,0 | M 5 |
| 05104643001 | 5,0 | 12,00 | 44,0 | M 6 |
| 05104644001 | 6,8 | 12,00 | 51,0 | M 8 |
| 05104645001 | 8,5 | 12,00 | 59,0 | M 10 |





846 3-flute Countersink Bit



Application: For deburring, chamfering, countersinking

Design: 3-flute 90° DIN 335-C cutter

Drive: 1/4" hexagon suitable for holders with DIN ISO 1173-D 6,3 receiver

| |  |  |  |  |
|-------------|---|---|---|---|
| | mm | mm | mm | |
| 05104630001 | 6,30 | 20,00 | 31,0 | M 3 |
| 05104631001 | 8,30 | 20,00 | 31,0 | M 4 |
| 05104632001 | 10,40 | 20,00 | 34,0 | M 5 |
| 05104633001 | 12,40 | 20,00 | 35,0 | M 6 |
| 05104634001 | 16,50 | 20,00 | 40,0 | M 8 |
| 05104635001 | 20,50 | 20,00 | 41,0 | M 10 |





846/8 3-flute Countersink Bits Set



8 pieces in robust case

1 Kraftform quick release bitholding screwdriver 816 R

1 universal bit holder 888/4/1 K Rapidaptor suitable for power tools and electronic drills; countersink bits with 1/4" drive suitable for power tools with DIN ISO 1173-D 6,3 receiver.

|  | | |
|---|------------------|--|
| 05104650001 | | |
|  | 816 R | 1 x 1/4"x119 |
|  | 888/4/1 K | 1 x 1/4"x50 |
|  | 846 HSS | 1 x 6,30x31,0; 1 x 8,30x31,0; 1 x 10,40x34,0; 1 x 12,40x35,0; 1 x 16,50x40,0; 1 x 20,50x41,0 |

847/7 Set Combination Drill Bits Set



7 pieces in robust case

1 Universal bit holder Rapidaptor 888/4/1 K with quick-release chuck suitable for power tools and electronic drills; combination drill bits, 1/4" drive, suitable for power tools with DIN ISO 1173-D 6,3 receiver.

| | | |
|-------------|---|--|
| 05104651001 | | |
| 888/4/1 K | 1 x 1/4"x50 | |
| 847 HSS | 1 x 2,5x36,0; 1 x 3,3x39,0; 1 x 4,2x41,0; 1 x 5,0x44,0; 1 x 6,8x51,0; 1 x 8,5x59,0 | |

848 HSS Metal Twist Drill Bits



Application: For precise drilling in metal

Construction: HSS

Drive: 1/4" hexagon, suitable for DIN ISO 1173-D 6,3 holders

| | mm | mm | mm |
|-------------|------|-------|------|
| 05104610001 | 3,0 | 16,00 | 38,0 |
| 05104611001 | 3,1 | 18,00 | 40,0 |
| 05104612001 | 3,3 | 18,00 | 40,0 |
| 05104613001 | 4,0 | 20,00 | 44,0 |
| 05104614001 | 4,1 | 20,00 | 44,0 |
| 05104615001 | 4,2 | 20,00 | 45,0 |
| 05104616001 | 5,0 | 26,00 | 50,0 |
| 05104617001 | 5,1 | 26,00 | 50,0 |
| 05104618001 | 6,0 | 26,00 | 50,0 |
| 05104619001 | 6,8 | 30,00 | 50,0 |
| 05104620001 | 8,0 | 32,00 | 51,0 |
| 05104621001 | 8,5 | 33,00 | 53,0 |
| 05104622001 | 10,0 | 38,00 | 54,0 |

849 HSS Twist Wood Drill Bits



Application: For point-precision, splinter-free drilling in soft woods, hard woods, and laminated panel material

Design: HSS

Drive: 1/4" hexagon, suitable for DIN ISO 1173-D 6,3 holders

| | mm | mm | mm |
|-------------|------|-------|-------|
| 05104600001 | 3,0 | 32,00 | 70,0 |
| 05104601001 | 4,0 | 32,00 | 74,0 |
| 05104602001 | 5,0 | 43,00 | 85,0 |
| 05104603001 | 6,0 | 45,00 | 95,0 |
| 05104604001 | 8,0 | 60,00 | 110,0 |
| 05104605001 | 10,0 | 70,00 | 120,0 |

848/851/867/19 Metal Twist Drill Bits and Bits Set



19 pieces in robust belt pouch

1 Universal bit holder Rapidaptor 888/4/1 K suitable for power tools and electronic drills; metal twist Drill Bits and Bits with 1/4" drive, suitable for power tools with DIN ISO 1173-D 6,3 receiver.

| | | |
|-------------|---|--|
| 05104652001 | | |
| 888/4/1 K | 1 x 1/4"x50 | |
| 851/1 TZ PH | 2 x PH 1x25; 3 x PH 2x25; 1 x PH 3x25 | |
| 848 HSS | 1 x 3,0x38,0; 1 x 4,0x44,0; 1 x 4,2x45,0; 1 x 5,0x50,0; 1 x 6,0x50,0; 1 x 8,0x51,0 | |
| 867/1 TORX® | 1 x TX 10x25; 1 x TX 15x25; 1 x TX 20x25; 1 x TX 25x25; 1 x TX 30x25; 1 x TX 40x25 | |





849/855/867/18 Wood Twist Drill Bits and Bits Set



18 pieces in robust belt pouch

1 Universal bit holder Rapidaptor 889/4/1 K suitable for power tools and electronic drills; wood Twist Drill Bit and Bits, 1/4" drive, suitable for power tools with DIN ISO 1173-D 6,3 receiver.

| | |
|-------------|---|
| 05104653001 | |
| ● ○ | 889/4/1 K 1 x 1/4"x50 |
| ⊗ | 849 HSS 1 x 3,0x70,0; 1 x 4,0x74,0; 1 x 5,0x85,0; 1 x 6,0x95,0; 1 x 8,0x110,0 |
| ⊕ | 855/1 TH PZ 2 x PZ 1x25; 3 x PZ 2x25; 1 x PZ 3x25 |
| ⊗ | 867/1 TORX® 1 x TX 10x25; 1 x TX 15x25; 1 x TX 20x25; 1 x TX 25x25; 1 x TX 30x25; 1 x TX 40x25 |

Bit-Check 10 Drywall 1



1 bit holder 896/4/1 out of Aluminium with adjustable depth stop suitable for power tools and electronic drills; screw depth can be infinitely adjusted and enables flush alignment of sunken screws; 9 drywall construction bits with modified drive shaft; length 25mm

| | |
|-------------|-------------------------|
| 05136011001 | |
| ● ○ | 896/4/1 1 x 1/4"x50 |
| ⊕ | 851/1 RZ PH 9 x PH 2x25 |

Tip

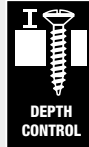

Bit holder with adjustable depth stop



The screw installation depth can be infinitely adjusted and allows the desired degree of countersinking of the screws.





Torque Tools



Series 7400
Adjustable Torque Screwdrivers

470



Series 7400
Pre-set, Adjustable Torque
Screwdrivers

478



Series Torque-indicators

484



Series Click-Torque Wrenches

490



Series Insert Tools

502



Torque Tools

Wera's torque tools offer torque-controlled screw tightening so as to avoid damage to the screw or workpiece and to ensure the integrity of the screw connection. This makes work-intensive drilling-out of screws and unproductive downtimes a thing of the past. It is also important whenever repeat accuracy is required.

They come with an ergonomic Kraftform handle and have a distinctly audible and perceptible click signal whenever the required torque value is reached.

No time-consuming blade changes; instead of special blades, conventional bits conforming to C 6,3 and E 6,3 or even ¼" sockets can be used.



Adjustable torque screwdrivers

They can be adjusted by hand to the corresponding scale value. Also available in ESD version (also with take-up for HIOS/Halfmoon bits) and with Kraftform Micro handle. See page 470.

For the insulated VDE-version see page 114.

Pre-set, adjustable torque screwdrivers

Pre-set torque, adjustable within a defined range. Also available in ESD version (also for HIOS/Halfmoon bits) and with Kraftform Micro handle.

See page 478.



Torque-indicators

Suitable for applications requiring a non-adjustable i.e. a tamperproof torque blade assembly.
See page 484.



Series Click-Torque wrenches

Suitable for controlled tightening using sockets.
See page 490.



Adjustable Torque Screwdrivers

Wera's adjustable torque screwdrivers allow variable torque settings with maximum precision and ensure that the user gets the very best results in the familiar Wera design with superior ergonomics.



Simple setting of the required torque by hand.



Easy-to-read scale value.



Measurement accuracy is $\pm 6\%$ in accordance with the standard DIN EN ISO 6789. Distinctly audible and noticeable excess-load signal when the pre-set torque is reached.

All Wera torque screwdrivers manufactured according to DIN EN ISO 6789 are supplied with a calibration certificate. Our workshop offers a comprehensive service for all Wera torque tools. Please contact us with any queries regarding service, recalibration or repair on +49 (0)202 40 45 145; Fax: +49 (0)202 40 45 158 or per E-Mail at: torqueservice@wera.de.



Rapidaptor technology makes the tool adaptable since bits and sockets can be exchanged rapidly.



Unlimited torque for loosening seized screws.



Multi-component Kraftform handle with hard and soft zones for fast working speeds and protecting the palm of the hand.

For the insulated VDE-version see page 114.



Series 7400 Kraftform Torque Screwdrivers

Variable torque adjustment models

Series 7400 Kraftform adjustable torque screwdrivers (0.1-3.0 Nm) with Rapidaptor quick-release chuck



Application: Suitable for 1/4" DIN ISO 1173-C 6,3 and E 6,3 hexagon insert bits and Wera Series 1 and 4

Design: Rapidaptor rapid-in, rapid-out, rapid-spin, chuck-all and single-hand technology

Accuracy: ±6 % (DIN EN ISO 6789). Numerical torque value scale, audible excess-load signal

Handle: Kraftform with non-roll feature, multi-component

| | Art.No. | mm | 1/4" | Nm | Nm | mm | 1/16" |
|---------------------------|---------|-----|------|-----------|-------|-----|---------|
| 05074770001 ¹⁾ | 7430 | 89 | 1/4" | 0,10-0,34 | 0,015 | 142 | 5 7/16" |
| 05074772001 ¹⁾ | 7431 | 89 | 1/4" | 0,30-1,00 | 0,05 | 142 | 5 7/16" |
| 05074774001 ¹⁾ | 7432 | 89 | 1/4" | 0,90-1,50 | 0,05 | 142 | 5 7/16" |
| 05074700001 | 7440 | 105 | 1/4" | 0,3-1,2 | 0,05 | 155 | 6" |
| 05074701001 | 7441 | 105 | 1/4" | 1,2-3,0 | 0,10 | 155 | 6" |

¹⁾ With attachable magnifying glass, dramatically improving visibility.

Series 7400 Kraftform pistol grip, adjustable torque screwdrivers (3.0-8.8 Nm) with Rapidaptor quick-release chuck



Application: Suitable for 1/4" DIN ISO 1173-C 6,3 and E 6,3 hexagon insert bits and Wera Series 1 and 4

Design: Rapidaptor rapid-in, rapid-out, rapid-spin, chuck-all and single-hand technology

Accuracy: ±6 % (DIN EN ISO 6789). Numerical torque value scale, audible excess-load signal

Handle: Kraftform pistol grip, multi-component

| | Art.No. | 1/4" | Nm | Nm | mm | mm | 1/16" |
|-------------|---------|------|---------|------|-----|-----|-------|
| 05074702001 | 7442 | 1/4" | 3,0-6,0 | 0,25 | 150 | 100 | 4" |
| 05074705001 | 7443 | 1/4" | 4,0-8,8 | 0,40 | 150 | 100 | 4" |



Rapidaptor

Series 7400 Kraftform ESD adjustable torque screwdrivers (0.1-3.0 Nm) with Rapidaptor quick-release chuck



Application: Suitable for 1/4" DIN ISO 1173-C 6,3 and E 6,3 hexagon insert bits and Wera Series 1 and 4

Design: Rapidaptor rapid-in, rapid-out, rapid-spin, chuck-all and single-hand technology, non-magnetic

Accuracy: ±6 % (DIN EN ISO 6789). Numerical torque value scale, audible excess-load signal

Handle: Kraftform with non-roll feature, multi-component

| | Art.No. | mm | 1/4" | Nm | Nm | mm | 1/16" |
|---------------------------|----------|-----|------|-----------|-------|-----|---------|
| 05074780001 ¹⁾ | 7430 ESD | 89 | 1/4" | 0,10-0,34 | 0,015 | 142 | 5 7/16" |
| 05074782001 ¹⁾ | 7431 ESD | 89 | 1/4" | 0,30-1,00 | 0,05 | 142 | 5 7/16" |
| 05074784001 ¹⁾ | 7432 ESD | 89 | 1/4" | 0,90-1,50 | 0,05 | 142 | 5 7/16" |
| 05074730001 | 7440 ESD | 105 | 1/4" | 0,3-1,2 | 0,05 | 155 | 6" |
| 05074731001 | 7441 ESD | 105 | 1/4" | 1,2-3,0 | 0,10 | 155 | 6" |

¹⁾ With attachable magnifying glass, dramatically improving visibility.

Rapid-in and self-lock



The bit can be pushed into the adaptor without moving the sleeve. The lock is activated automatically as soon as the bit is applied to the screw. Bits are held securely and wobble-free.

Rapid-out



Simply push the sleeve forward to change the bit. The spring mechanism lifts the bit off the magnet and unlocks the tool. The bit can be easily removed. The rapid-out function makes it easy to remove even the smallest bits without extra tools.

Chuck-all



The Rapidaptor quick-release chucks hold 1/4" DIN ISO 1173-C 6,3 and E 6,3 as well as Wera series 1 and 4 bits.

Single-hand function



Every function of the Rapidaptor quick-release chuck, such as inserting or releasing bits, can be carried out with one hand. This is faster, more economical and more ergonomic. There are no unnecessary manoeuvres.

Attachable magnifying glass



Articles 7430, 7431, 7432, 7430 ESD, 7431 ESD, 7432 ESD, 7435 ESD, 7436 ESD, 1430 ESD and 1431 ESD all come with a magnifying glass. This can be easily attached on to the scale, dramatically improving visibility.



Series 7400 Kraftform Torque Screwdrivers

Variable torque adjustment models

Series 7400 Kraftform pistol grip, adjustable torque screwdrivers (25.0-55.0 in. lbs.) with Rapidaptor quick-release chuck



- Application:** Suitable for 1/4" DIN ISO 1173-C 6,3 and E 6,3 hexagon insert bits and Wera Series 1 and 4
- Design:** Rapidaptor rapid-in, rapid-out, rapid-spin, chuck-all and single-hand technology
- Accuracy:** ±6 % (DIN EN ISO 6789). Numerical torque value scale. Audible excess-load signal
- Handle:** Kraftform pistol grip, multi-component

| | Art.No. | in. lbs. | in. lbs. | mm | mm | | |
|-------------|---------|----------|-----------|-----|-----|-----|----|
| 05074712001 | 7447 | 1/4" | 25,0-55,0 | 2,5 | 150 | 100 | 4" |

Series 7400 Kraftform ESD adjustable torque screwdrivers (2.5-29.0 in.lbs.) with Rapidaptor quick-release chuck



- Application:** Suitable for 1/4" DIN ISO 1173-C 6,3 and E 6,3 hexagon insert bits and Wera Series 1 and 4
- Design:** Rapidaptor rapid-in, rapid-out, rapid-spin, chuck-all and single-hand technology, non-magnetic
- Accuracy:** ±6 % (DIN EN ISO 6789). Numerical torque value scale. Audible excess-load signal
- Handle:** Kraftform with non-roll feature, multi-component

| | Art.No. | in. lbs. | in. lbs. | mm | mm |
|-------------|----------|----------|-----------|-----|-----|
| 05074733001 | 7445 ESD | 1/4" | 2,5-11,5 | 0,5 | 155 |
| 05074734001 | 7446 ESD | 1/4" | 11,0-29,0 | 1,0 | 155 |

Series 7400 Kraftform adjustable torque screwdrivers (2.5-29.0 in. lbs.) with Rapidaptor quick-release chuck



- Application:** Suitable for 1/4" DIN ISO 1173-C 6,3 and E 6,3 hexagon insert bits and Wera Series 1 and 4
- Design:** Rapidaptor rapid-in, rapid-out, rapid-spin, chuck-all and single-hand technology
- Accuracy:** ±6 % (DIN EN ISO 6789). Numerical torque value scale. Audible excess-load signal
- Handle:** Kraftform with non-roll feature, multi-component

| | Art.No. | in. lbs. | in. lbs. | mm | mm |
|-------------|---------|----------|-----------|-----|-----|
| 05074710001 | 7445 | 1/4" | 2,5-11,5 | 0,5 | 155 |
| 05074711001 | 7446 | 1/4" | 11,0-29,0 | 1,0 | 155 |

Series 7400 Kraftform ESD adjustable torque screwdrivers (0.1-1.0 Nm)



Application: Suitable for bits with 4 mm Halfmoon drive (and Wera Serie 9) and 4 mm HIOS drive (and Wera Series 21)

Design: With quick-release chuck for rapid bit change

Accuracy: ±6 % (DIN EN ISO 6789)

Handle: Kraftform with non-roll feature, multi-component

| | Art.No. | mm | Nm | Nm | mm | mm |
|---------------------------|----------|----|-----------|-------|-----|---------|
| 05074786001 ¹⁾ | 7435 ESD | 89 | 0,10-0,34 | 0,015 | 142 | 5 7/16" |
| 05074788001 ¹⁾ | 7436 ESD | 89 | 0,30-1,00 | 0,05 | 142 | 5 7/16" |

¹⁾ With attachable magnifying glass, dramatically improving visibility.

1430 Kraftform Micro ESD adjustable torque screwdrivers (0.02-0.11 Nm) with quick-release chuck

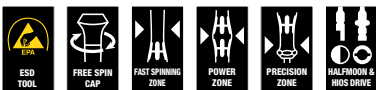

Application: Suitable for bits with 4 mm Halfmoon drive (and Wera Serie 9) and 4 mm HIOS drive (and Wera Series 21)

Design: With quick-release chuck for rapid bit change

Accuracy: ± 10%

Handle: Kraftform Micro with non-roll feature and rotating cap, multi-component

| | Art.No. | Nm | Nm | mm | mm |
|---------------------------|----------|-----------|--------|-----|---------|
| 05074802001 ¹⁾ | 1430 ESD | 0,02-0,06 | 0,0025 | 141 | 5 7/16" |
| 05074804001 ¹⁾ | 1431 ESD | 0,05-0,11 | 0,005 | 141 | 5 7/16" |

¹⁾ With attachable magnifying glass, dramatically improving visibility.

Tip

Attachable magnifying glass



Articles 7435 ESD, 7436 ESD, 1430 ESD and 1431 ESD, all come with a magnifying glass. This can be easily attached on to the scale, dramatically improving visibility.

Why does Wera manufacture adjustable Kraftform torque screwdrivers?



Many screws – particularly in assembly and maintenance applications – have to be tightened with controlled torque to ensure the dependability of the screw connection and/or to avoid damage to the screw or work piece. Wera's adjustable torque screwdrivers are the ideal tool for this. They feature a torque range of 0.3 Nm

to 8.8 Nm, two different handles, measurement accuracy of ± 6 % and Rapidaptor technology for rapid bit change.

For Halfmoon and HIOS Bits



The adjustable torque screwdrivers 7435 ESD, 7436 ESD, 1430 ESD and 1431 ESD feature a combination bitholder for both bits with Halfmoon and bits with HIOS drive.



Series 7400 Kraftform Torque Screwdrivers

Variable torque adjustment models

7440/41 Kraftform torque screwdriver set 0.3-3.0 Nm

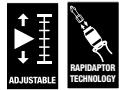

| | | |
|-------------|------------------------------|--|
| 05074738001 | | |
| ● | 7400 | 1 x 7440x1/4"x0,3-1,2; 1 x 7441x1/4"x1,2-3,0 |
| ⊕ | 867/1 TZ TORX® | 1 x TX 6x25; 1 x TX 7x25; 1 x TX 8x25; 1 x TX 9x25; 1 x TX 10x25; 1 x TX 15x25; 1 x TX 20x25; 1 x TX 25x25; 1 x TX 30x25 |
| ⊕ | 867/1 Z IP TORX PLUS® | 1 x 6 IPx25; 1 x 7 IPx25; 1 x 8 IPx25; 1 x 9 IPx25; 1 x 10 IPx25; 1 x 15 IPx25; 1 x 20 IPx25; 1 x 25 IPx25; 1 x 30 IPx25 |
| ○ | 840/1 Z Hex-Plus | 1 x 2,0x25; 1 x 2,5x25; 1 x 3,0x25; 1 x 4,0x25; 1 x 5,0x25; 1 x 6,0x25 |

7440/41/42 Kraftform torque screwdriver set 0.3-6.0 Nm



| | | |
|-------------|------------------------------|--|
| 05074739001 | | |
| ● | 7400 | 1 x 7440x1/4"x0,3-1,2; 1 x 7441x1/4"x1,2-3,0 |
| ● | 7400 Pistole | 1 x 7442x3,0-6,0 |
| ⊕ | 867/1 TZ TORX® | 1 x TX 6x25; 1 x TX 7x25; 1 x TX 8x25; 1 x TX 9x25; 1 x TX 10x25; 1 x TX 15x25; 1 x TX 20x25; 1 x TX 25x25; 1 x TX 30x25 |
| ⊕ | 867/1 Z IP TORX PLUS® | 1 x 6 IPx25; 1 x 7 IPx25; 1 x 8 IPx25; 1 x 9 IPx25; 1 x 10 IPx25; 1 x 15 IPx25; 1 x 20 IPx25; 1 x 25 IPx25; 1 x 30 IPx25 |
| ○ | 840/1 Z Hex-Plus | 1 x 2,0x25; 1 x 2,5x25; 1 x 3,0x25; 1 x 4,0x25; 1 x 5,0x25; 1 x 6,0x25 |

7445/46/47 Kraftform torque screwdriver set 2.5-55.0 in.lbs.

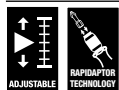

| | | |
|-------------|------------------------------|--|
| 05350451001 | | |
| ● | 7400 inch | 1 x 7445x2,5-11,5; 1 x 7446x11,0-29,0 |
| ● | 7400 Pistole inch | 1 x 7447x25,0-55,0 |
| ⊕ | 867/1 TZ TORX® | 1 x TX 6x25; 1 x TX 7x25; 1 x TX 8x25; 1 x TX 9x25; 1 x TX 10x25; 1 x TX 15x25; 1 x TX 20x25; 1 x TX 25x25; 1 x TX 30x25 |
| ⊕ | 867/1 Z IP TORX PLUS® | 1 x 6 IPx25; 1 x 7 IPx25; 1 x 8 IPx25; 1 x 9 IPx25; 1 x 10 IPx25; 1 x 15 IPx25; 1 x 20 IPx25; 1 x 25 IPx25; 1 x 30 IPx25 |
| ○ | 840/1 Z Hex-Plus | 1 x 2,0x25; 1 x 2,5x25; 1 x 3,0x25; 1 x 4,0x25; 1 x 5,0x25; 1 x 6,0x25 |

7443/61/9 Assembly set for tyre pressure control systems

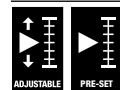

| | | |
|-------------|-----------------------|------------------------------|
| 05074745001 | | |
| ● | 7400 vor | 1 x 7461x3,3 ¹⁾ |
| ● | 7400 Pistole | 1 x 7443x4,0-8,8 |
| ⊕ | 300 TX | 1 x TX 10x1,4 |
| ⊕ | 870/1 | 1 x 1/4"x25 |
| ● | 790 A/50 | 1 x 11,0x50,0; 1 x 12,0x50,0 |
| ⊕ | 867/4 TORX® HF | 1 x TX 15x50; 1 x TX 20x50 |
| ○ | 327 | 1 x 32 |

¹⁾ Other pre-set values within the adjustable range <3.3 Nm can be delivered on request

Tip

Assembly sets for tyre control systems

Suitable for all leading system suppliers like Alligator, Beru, CUB, Herth & Buss, Schrader, VDO/Conti.

Including adjustable and pre-set torque tools, colour-coded valve insertion tool and valve dolly. The robust foam insert provides for a practical arrangement system.



7443/12 Assembly set for tyre pressure control systems

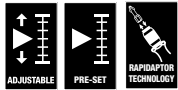

Suitable for all leading system suppliers such as Alligator, Beru, CUB, Herth & Buss, Schrader, VDO/Conti.

1 adjustable torque screwdriver, pistol handle, 4.0-8.8 Nm; 1 pre-set torque screwdriver 3.3 Nm; 1 pre-set torque screwdriver 1.4 Nm TX 10; 1 pre-set torque screwdriver 1.25 Nm TX 10; 1 valve dolly; 1 bit 867/4 HF TX 15 x 50 mm, with holding function for TORX® screws; 1 bit 867/4 HF TX 20 x 50 mm, with holding function for TORX® screws; 1 socket 790 A/50 SW 11.0 x 50 mm; 1 socket 790 A/50 SW 12.0 x 50 mm; 1 adaptor 870/1; 1/4" hexagon to 1/4" square; 1 valve insertion tool, pre-set torque: 0.25 Nm; 1 valve insertion tool, pre-set torque: 0.45 Nm.

Practically arranged in a robust foam insert.

| | |
|-------------|--|
| 05074746001 | |
| ● | 7400 Pistole 1 x 7443x4,0-8,8 |
| ● | 7400 vor 1 x 7461x3,3 ¹⁾ |
| ✦ | 300 TX 1 x TX 10x1,25; 1 x TX 10x1,4 |
| ● | 790 A/50 1 x 11,0x50,0; 1 x 12,0x50,0 |
| ✦ | 867/4 TORX® HF 1 x TX 15x50; 1 x TX 20x50 |
| ○ | 870/1 1 x 1/4"x25 |
| ● | 300 V 1 x 0,25; 1 x 0,45 |
| ○ | 327 1 x 32 |

¹⁾ Other pre-set values within the adjustable range < 3.3 Nm can be delivered on request



Pre-set, adjustable Torque Screwdrivers

These tools are ideal for all applications where a constant, identical torque is required and where a high degree of repeat accuracy is needed. The torque value can be adjusted within the measuring range.



Unlimited torque for loosening seized screws.



Distinctly audible and noticeable excess-load signal when the pre-set torque is reached.



Rapidaptor technology makes the tool adaptable since bits and sockets can be exchanged rapidly.



Multi-component Kraftform handle with hard and soft zones for fast working speeds and protecting the palm of the hand.

All Wera torque screwdrivers manufactured according to DIN EN ISO 6789 are supplied with a calibration certificate. Our workshop offers a comprehensive service for all Wera torque tools. Please contact us with any queries regarding service, recalibration or repair on +49 (0)202 40 45 145; Fax: +49 (0)202 40 45 158 or per E-Mail at: torqueservice@wera.de.



Series 7400 Kraftform Torque Screwdrivers

Pre-set, adjustable torque models

Serie 7400 Kraftform pre-set adjustable torque screwdrivers (0.1-3.0 Nm) with Rapidaptor quick-release chuck



Application: Suitable for 1/4" DIN ISO 1173-C 6,3 and E 6,3 hexagon insert bits and Wera Series 1 and 4

Design: Rapidaptor rapid-in, rapid-out, rapid-spin, chuck-all and single-hand technology

Pre-set torque: 0.1 Nm, 0.3 Nm, 0.9 Nm, 1.2 Nm

Accuracy: ± 6% (DIN EN ISO 6789)

Handle: Kraftform with non-roll feature, multi-component

| | Art.No. | mm | | Nm | Nm | mm | mm |
|---------------------------|---------|-----|------|-----|----------|-----|--------|
| 05074790001 | 7450 | 89 | 1/4" | 0,1 | 0,1-0,34 | 133 | 5 1/4" |
| 05074790010 ¹⁾ | 7450 | 89 | 1/4" | 0,1 | 0,1-0,34 | 133 | 5 1/4" |
| 05074792001 | 7451 | 89 | 1/4" | 0,3 | 0,3-1,0 | 133 | 5 1/4" |
| 05074792010 ¹⁾ | 7451 | 89 | 1/4" | 0,3 | 0,3-1,0 | 133 | 5 1/4" |
| 05074794001 | 7452 | 89 | 1/4" | 0,9 | 0,9-1,5 | 133 | 5 1/4" |
| 05074794010 ¹⁾ | 7452 | 89 | 1/4" | 0,9 | 0,9-1,5 | 133 | 5 1/4" |
| 05074715001 | 7460 | 105 | 1/4" | 0,3 | 0,3-1,2 | 155 | 6" |
| 05074715010 ¹⁾ | 7460 | 105 | 1/4" | 0,3 | 0,3-1,2 | 155 | 6" |
| 05074716001 | 7461 | 105 | 1/4" | 1,2 | 1,2-3,0 | 155 | 6" |
| 05074716010 ¹⁾ | 7461 | 105 | 1/4" | 1,2 | 1,2-3,0 | 155 | 6" |

¹⁾ Other pre-set values within the adjustable range can be delivered on request

Series 7400 Kraftform pistol grip, pre-set adjustable torque screwdrivers (3.0-8.8 Nm) with Rapidaptor quick-release chuck



Application: Suitable for 1/4" DIN ISO 1173-C 6,3 and E 6,3 hexagon insert bits and Wera Series 1 and 4

Design: Rapidaptor rapid-in, rapid-out, rapid-spin, chuck-all and single-hand technology

Pre-set torque: 3.0 Nm, 4.0 Nm

Accuracy: ± 6% (DIN EN ISO 6789)

Handle: Kraftform pistol grip, multi-component

| | Art.No. | Nm | Nm | mm | mm | | |
|---------------------------|---------|------|-----|---------|-----|-----|-------|
| 05074717001 | 7462 | 1/4" | 3,0 | 3,0-6,0 | 150 | 100 | 6" 4" |
| 05074717010 ¹⁾ | 7462 | 1/4" | 3,0 | 3,0-6,0 | 150 | 100 | 6" 4" |
| 05074728001 | 7463 | 1/4" | 4,0 | 4,0-8,8 | 150 | 100 | 6" 4" |
| 05074728010 ¹⁾ | 7463 | 1/4" | 4,0 | 4,0-8,8 | 150 | 100 | 6" 4" |

¹⁾ Other pre-set values within the adjustable range can be delivered on request

Serie 7400 Kraftform ESD pre-set adjustable torque screwdrivers (0.1-1.2 Nm) with Rapidaptor quick-release chuck



- Application:** Suitable for 1/4" DIN ISO 1173-C 6,3 and E 6,3 hexagon insert bits and Wera Series 1 and 4
- Design:** Rapidaptor rapid-in, rapid-out, rapid-spin, chuck-all and single-hand technology
- Pre-set torque:** 0.1 Nm, 0.3 Nm, 0.9 Nm, 1.2 Nm
- Accuracy:** ± 6% (DIN EN ISO 6789)
- Handle:** Kraftform with non-roll feature, multi-component

| | Art.No. | mm | | Nm | | mm | mm |
|---------------------------|----------|-----|------|-----|----------|-----|--------|
| 05074820001 | 7450 ESD | 89 | 1/4" | 0,1 | 0,1-0,34 | 133 | 5 1/4" |
| 05074820010 ¹⁾ | 7450 ESD | 89 | 1/4" | 0,1 | 0,1-0,34 | 133 | 5 1/4" |
| 05074822001 | 7451 ESD | 89 | 1/4" | 0,3 | 0,3-1,0 | 133 | 5 1/4" |
| 05074822010 ¹⁾ | 7451 ESD | 89 | 1/4" | 0,3 | 0,3-1,0 | 133 | 5 1/4" |
| 05074824001 | 7452 ESD | 89 | 1/4" | 0,9 | 0,9-1,5 | 133 | 5 1/4" |
| 05074824010 ¹⁾ | 7452 ESD | 89 | 1/4" | 0,9 | 0,9-1,5 | 133 | 5 1/4" |
| 05074840001 | 7460 ESD | 105 | 1/4" | 0,3 | 0,3-1,2 | 155 | 6" |
| 05074840010 ¹⁾ | 7460 ESD | 105 | 1/4" | 0,3 | 0,3-1,2 | 155 | 6" |
| 05074842001 | 7461 ESD | 105 | 1/4" | 1,2 | 1,2-3,0 | 155 | 6" |
| 05074842010 ¹⁾ | 7461 ESD | 105 | 1/4" | 1,2 | 1,2-3,0 | 155 | 6" |

¹⁾ Other pre-set values within the adjustable range can be delivered on request

Tip

Why does Wera manufacture pre-set, adjustable Kraftform torque screwdrivers?



These torque screwdrivers are supplied with a fixed pre-set torque value. This is ideal for all applications that require constant, identical torque. They feature a pre-set torque range of 0.3 Nm to 4.0 Nm (adjustable between 0.3 Nm – 8.8 Nm), two different handles, measurement accuracy of ± 6 % and Rapidaptor chuck technology for rapid bit change.

Customized pre-setting



The pre-set torque screwdrivers of the Kraftform 7400 series can be individually pre-set within the specified adjustable range.



Series 7400 Kraftform Torque Screwdrivers

Pre-set, adjustable torque models

Series 7400 Kraftform pre-set adjustable torque screwdrivers (2.5-29.0 in. lbs.) with Rapidaptor quick-release chuck







Application: Suitable for 1/4" DIN ISO 1173-C 6,3 and E 6,3 hexagon insert bits and Wera Series 1 and 4

Design: Rapidaptor rapid-in, rapid-out, rapid-spin, chuck-all and single-hand technology

Pre-set torque: 2.5 in.lbs., 11.0 in.lbs.

Accuracy: ±6 % (DIN EN ISO 6789)

Handle: Kraftform with non-roll feature, multi-component

| | Art.No. |  |  |  |  |  |
|---------------------------|---------|---|---|---|---|---|
| | | in. lbs. | in. lbs. | mm | | |
| 05074720001 | 7465 | 1/4" | 2,5 | 2,5-11,5 | 155 | 6" |
| 05074720010 ¹⁾ | 7465 | 1/4" | 2,5 | 2,5-11,5 | 155 | 6" |
| 05074722001 | 7466 | 1/4" | 11,0 | 11,0-29,0 | 155 | 6" |
| 05074722010 ¹⁾ | 7466 | 1/4" | 11,0 | 11,0-29,0 | 155 | 6" |

¹⁾ Other pre-set values within the adjustable range can be delivered on request

Series 7400 Kraftform pistol grip, pre-set adjustable torque screwdriver (25.0-55.0 in. lbs.) with Rapidaptor quick-release chuck









Application: Suitable for 1/4" DIN ISO 1173-C 6,3 and E 6,3 hexagon insert bits and Wera Series 1 and 4

Design: Rapidaptor rapid-in, rapid-out, rapid-spin, chuck-all and single-hand technology

Pre-set torque: 25.0 in. lbs.

Accuracy: ±6 % (DIN EN ISO 6789)

Handle: Kraftform pistol grip, multi-component

| | Art.No. |  |  |  |  |  |  |  |
|---------------------------|---------|---|---|---|---|---|---|---|
| | | in. lbs. | in. lbs. | mm | mm | | | |
| 05074721001 | 7467 | 1/4" | 25,0 | 25,0-55,0 | 150 | 100 | 6" | 4" |
| 05074721010 ¹⁾ | 7467 | 1/4" | 25,0 | 25,0-55,0 | 150 | 100 | 6" | 4" |

¹⁾ Other pre-set values within the adjustable range can be delivered on request

Serie 7400 Kraffform pre-set adjustable torque screwdrivers (0.1-1.0 Nm) with quick-release chuck



- Application:** Suitable for bits with 4 mm Halfmoon drive (and Wera Serie 9) and 4 mm HIOS drive (and Wera Series 21)
- Design:** With quick-release chuck for rapid bit change
- Pre-set torque:** 0.1 Nm, 0.3 Nm
- Accuracy:** ± 6% (DIN EN ISO 6789)
- Handle:** Kraffform with non-roll feature, multi-component

| | Art.No. | mm | Nm | Nm | mm | mm |
|---------------------------|----------|----|-------|----------|-----|--------|
| 05074826001 | 7455 ESD | 89 | 0,015 | 0,1-0,34 | 138 | 5 1/4" |
| 05074826010 ¹⁾ | 7455 ESD | 89 | 0,015 | 0,1-0,34 | 138 | 5 1/4" |
| 05074828001 | 7456 ESD | 89 | 0,035 | 0,3-1,0 | 138 | 5 1/4" |
| 05074828010 ¹⁾ | 7456 ESD | 89 | 0,035 | 0,3-1,0 | 138 | 5 1/4" |

¹⁾ Other pre-set values within the adjustable range can be delivered on request

1460 Kraffform Micro ESD pre-set adjustable torque screwdrivers (0.02-0.11 Nm) with quick-release chuck



- Application:** Suitable for bits with 4 mm Halfmoon drive (and Wera Serie 9) and 4 mm HIOS drive (and Wera Series 21)
- Design:** With quick-release chuck for rapid bit change
- Pre-set torque:** 0.035 Nm, 0.05 Nm
- Accuracy:** ± 10%
- Handle:** Kraffform Micro with non-roll feature and rotating cap, multi-component

| | Art.No. | Nm | Nm | mm | mm |
|---------------------------|----------|-------|-----------|-----|--------|
| 05074800001 | 1460 ESD | 0,035 | 0,02-0,06 | 131 | 5 1/4" |
| 05074800010 ¹⁾ | 1460 ESD | 0,035 | 0,02-0,06 | 131 | 5 1/4" |
| 05074810001 | 1461 ESD | 0,050 | 0,05-0,11 | 131 | 5 1/4" |
| 05074810010 ¹⁾ | 1461 ESD | 0,050 | 0,05-0,11 | 131 | 5 1/4" |

¹⁾ Other pre-set values within the adjustable range can be delivered on request

Tip



ESD-safe tools



The requirements for ESD-safe screwdrivers are specified in the European standard DIN EN 61340-5-1. This standard also includes a handle that has to be out of a defined conductive material. The Wera products in the ESD series satisfy these standards and the even more stringent requirements demanded by some technology companies.

For Halfmoon and HIOS Bits



The adjustable torque screwdrivers 7455 ESD, 7456 ESD, 1460 ESD and 1461 ESD feature a combination bitholder for both bits with Halfmoon and bits with HIOS drive.

Customized pre-setting



The pre-set torque screwdrivers of the Kraffform 7400 series can be individually pre-set within the specified adjustable range.



Torque-indicators

Wera torque-indicators have been factory pre-set to values recommended by leading carbide tool manufacturers. These tightening values relate specifically to the size of the TORX®, TORX PLUS® or hexagon socket screw. Torque indicators ensure safe and easy loosening of screw connections. Precision : $\pm 10\%$



Torque blade assembly precisely adjusted to the respective screw size for the TORX®, TORX PLUS® and hexagon socket screw profiles.



Non-adjustable and tamperproof.



Distinctly audible and noticeable excess-load signal when the pre-set torque is reached.



Slim 4 mm hexagon blades to reach screws in difficult-to-access places.

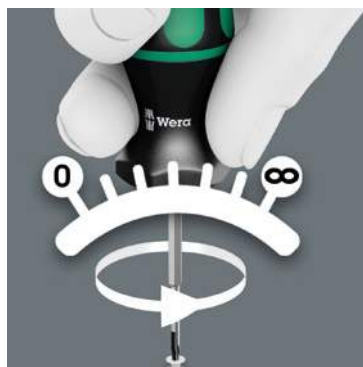

Unlimited torque for loosening seized screws.



Multi-component Kraftform handle with hard and soft zones for fast working speeds and protecting the palm of the hand.



610091740
Z = -55.736
X = -51.164

TX 10
20Nm
021934

TX 10
20Nm



Series Torque-indicators

Pre-set torque models

300 Hex torque-indicator



- Application:** Hexagon socket screws
- Pre-set torque:** 1.4 Nm-3.0 Nm (1.0 ft.lb.-2.2 ft.lb.), fixed pre-sets
- Accuracy:** ±10 %
- Blade:** Hexagonal, 4 mm, reduced diameter tip
- Design:** Hex-Plus, Black Point
- Handle:** Kraftform with non-roll feature, multi-component

| | | Nm | ft. lb. | mm | mm | mm | mm | mm |
|-------------|-----|-----|---------|----|-----|----|-----|---------|
| 05027910001 | 2,0 | 1,4 | 1,0 | 4 | 3,5 | 65 | 105 | 2 9/16" |
| 05027911001 | 2,5 | 2,0 | 1,5 | 4 | 3,8 | 65 | 105 | 2 9/16" |
| 05027912001 | 3,0 | 3,0 | 2,2 | 4 | 3,8 | 65 | 105 | 2 9/16" |

300 IP TORX PLUS® torque-indicator



- Application:** TORX PLUS® socket screws
- Pre-set torque:** 0.6 Nm-3.0 Nm (0.4 ft.lb.-3.0 ft.lb.), fixed pre-sets
- Accuracy:** ±10 %
- Blade:** Hexagonal, 4 mm, reduced diameter tip
- Design:** Black Point
- Handle:** Kraftform with non-roll feature, multi-component

| | | Nm | ft. lb. | mm | mm | mm | mm | mm |
|-------------|-------|-----|---------|----|-----|----|-----|---------|
| 05028040001 | 6 IP | 0,6 | 0,4 | 4 | 3,5 | 65 | 105 | 2 9/16" |
| 05028041001 | 7 IP | 0,9 | 0,7 | 4 | 3,5 | 65 | 105 | 2 9/16" |
| 05028042001 | 8 IP | 1,2 | 0,9 | 4 | 3,5 | 65 | 105 | 2 9/16" |
| 05028043001 | 9 IP | 1,4 | 1,0 | 4 | 3,5 | 65 | 105 | 2 9/16" |
| 05028044001 | 10 IP | 2,0 | 1,5 | 4 | 3,8 | 65 | 105 | 2 9/16" |
| 05028045001 | 15 IP | 3,0 | 2,2 | 4 | 3,8 | 65 | 105 | 2 9/16" |

300 Hex torque-indicator, pistol grip



- Application:** Hexagon socket screws
- Pre-set torque:** 5.0 Nm (3.7 ft. lb.), fixed pre-set
- Accuracy:** ±10 %
- Blade:** Hexagonal, 8 mm, reduced diameter tip
- Design:** Hex-Plus, Black Point
- Handle:** Kraftform pistol grip, multi-component

| | | | | mm | mm | mm | mm |
|-------------|-----|-----|-----|----|---------|----|----|
| 05027913001 | 4,0 | 160 | 100 | 65 | 2 9/16" | 25 | 1" |

300 TX TORX® torque-indicator









- Application:** TORX® socket screws
- Pre-set torque:** 0.6 Nm-3.0 Nm (0.4 ft.lb.-2.2 ft.lb.), fixed pre-sets
- Accuracy:** ±10 %
- Blade:** Hexagonal, 4 mm, reduced diameter tip
- Design:** Black Point
- Handle:** Kraftform with non-roll feature, multi-component

| | | Nm | ft. lb. | mm | mm | mm | mm | mm |
|-------------|-------|-----|---------|----|-----|----|-----|---------|
| 05027930001 | TX 6 | 0,6 | 0,4 | 4 | 3,5 | 65 | 105 | 2 9/16" |
| 05027931001 | TX 7 | 0,9 | 0,7 | 4 | 3,5 | 65 | 105 | 2 9/16" |
| 05027932001 | TX 8 | 1,2 | 0,9 | 4 | 3,5 | 65 | 105 | 2 9/16" |
| 05027933001 | TX 9 | 1,4 | 1,0 | 4 | 3,5 | 65 | 105 | 2 9/16" |
| 05027934001 | TX 10 | 2,0 | 1,5 | 4 | 3,8 | 65 | 105 | 2 9/16" |
| 05027935001 | TX 15 | 3,0 | 2,2 | 4 | 3,8 | 65 | 105 | 2 9/16" |

300 IP TORX PLUS® torque-indicator, pistol grip









- Application:** TORX PLUS® socket screws
- Pre-set torque:** 5.0 Nm (3.7 ft. lb.), fixed pre-set
- Accuracy:** ±10 %
- Blade:** Hexagonal, 8 mm, reduced diameter tip
- Design:** Black Point
- Handle:** Kraftform pistol grip, multi-component

| |  |  |  |  |  |  |  |
|-------------|---|---|---|---|---|---|---|
| | | mm | mm | mm | mm | mm | mm |
| 05028046001 | 20 IP | 160 | 100 | 65 | 2 9/16" | 25 | 1" |

300 TX TORX® torque-indicator, pistol grip



- Application:** TORX® socket screws
- Pre-set torque:** 5.0 Nm (3.7 ft. lb.), fixed pre-set
- Accuracy:** ±10 %
- Blade:** Hexagonal, 8 mm, reduced diameter tip
- Design:** Black Point
- Handle:** Kraftform pistol grip, multi-component

| |  |  |  |  |  |  |  |
|-------------|---|---|---|---|---|---|---|
| | | mm | mm | mm | mm | mm | mm |
| 05027936001 | TX 20 | 160 | 100 | 65 | 2 9/16" | 25 | 1" |

Tip

Less is often more

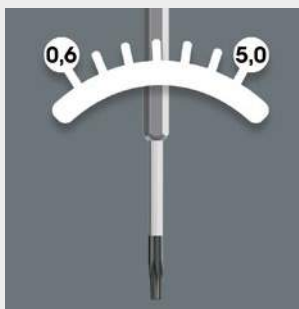

unlimited loosening torque, two handles, tamper-proof.

Some screw connections require specific torque values so that they can be tightened or loosened easily. Wera torque-indicators are pre-set to torque values recommended by leading carbide tool manufacturers. Pre-set torque between 0.6 Nm and 5.0 Nm, for TORX®, TORX PLUS® and hexagon socket screws,







NUMERIK

700239

Das Menü enthält

Funktionswahl

23.01.14 12:23

Betriebsart EINRICHTEN, Funktionsanwahl

Handwähler: 134020133

Handwähler: Betriebsartwahl Endzustand

| Maschine Einheit 1 / 2 | Maschine Greifer |
|---|--|
| <input type="checkbox"/> M-100 Mikrow. Handgriffe (SP1) | <input type="checkbox"/> M-110 Überkopfgraber 1 |
| <input type="checkbox"/> M-100 Mikrow. Überkopfgraber 1 | <input type="checkbox"/> M-110 Überkopfgraber 2 |
| <input type="checkbox"/> M-110 Mikrow. Handgriffe (SP2) | <input type="checkbox"/> M-120 Überkopfgraber 1 |
| <input type="checkbox"/> M-120 Mikrow. Überkopfgraber 2 | <input type="checkbox"/> M-130 Überkopfgraber 2 |
| <input type="checkbox"/> M-130 Quaderfah. Ladekl. | <input type="checkbox"/> M-140 Ladekopfgraber 1 |
| <input type="checkbox"/> M-140 Mikrow. Überkopfgraber 1 | <input type="checkbox"/> M-150 Ladekopfgraber 2 |
| <input type="checkbox"/> M-140 Mikrow. Ladekopfgr. | <input type="checkbox"/> M-160 Ladekopfgraber 2 |
| <input type="checkbox"/> M-150 Mikrow. Greifer | <input type="checkbox"/> M-170 Rad. Schwenkgrabergriffe |
| <input type="checkbox"/> M-160 Mikrow. Ergreifgr. | <input type="checkbox"/> M-180 Schwenkgrabergriffe schwenken |
| <input type="checkbox"/> M-170 Quaderfah. | <input type="checkbox"/> M-190 Schwenkgrabergriffe schwenken |
| <input type="checkbox"/> M-180 Greifergreifgr. | <input type="checkbox"/> M-200 Schwenkgrabergriffe schwenken |
| <input type="checkbox"/> M-190 Greifergreifgr. | |
| <input type="checkbox"/> M-200 Greifergreifgr. | |

Funktion anspalten Ladegeräte neu Ladegeräte testen

Maschine, Ladung, Verarbeiten, Staubsauger, Bedienung, Dokument, Wartung, Diagnose

Emergency stop button (red)

Function buttons grid

Rotary dials

Key switch

Toggle switches

Emergency stop button (red)

Key switch



Click-Torque Wrench Series

We wanted working with torque wrenches to be simple and accurate – which is why we developed the Click-Torque wrenches.

With the ability to set and save the default values and with the unmistakable, robust Wera design, these torque wrenches are the ideal tools for all bolting applications that require torque-controlled tightening (clockwise torque wrenches) and tightening and loosening (torque wrenches for insert tools).



Precise to $\pm 3\%$ as per DIN EN ISO 6789-1:2017-07.



Easy setting and saving of the desired torque value; readable on the main and fine scales.



With audible and tactile clicks when adjusting the scale values.

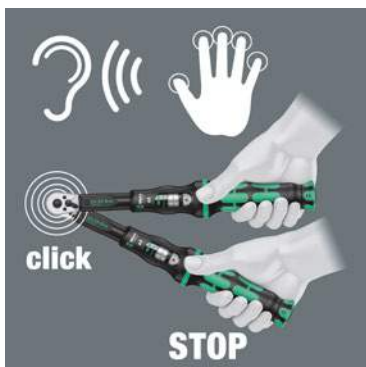

When the set torque value is reached, an audible and tactile mechanism triggers.

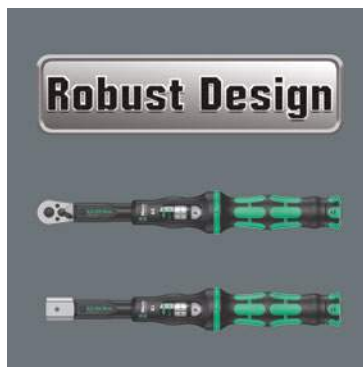

Very robust design with reversible ratchet (45 teeth) or for insert tools (9x12 mm or 14x18 mm) and ergonomic 2-component handle.



The reversible Click-Torque wrenches are for right-handed use, the Click-Torque wrenches for insert tools are suitable for right-hand and left-hand uses.



The Click-Torque wrenches are available for clockwise torque-controlled tightening with a reversible ratchet ($\frac{1}{4}$ " , $\frac{3}{8}$ " , $\frac{1}{2}$ " and $\frac{3}{4}$ " drive) or for insert tools (9x12 mm, 14x18 mm) for torque ranges from 2.5 Nm to 1000 Nm.

All Wera Click-Torque wrenches manufactured according to DIN EN ISO 6789 are supplied with a Declaration of conformity. Our workshop offers a comprehensive service for all Wera torque tools. Please contact us with any queries regarding service, recalibration or repair on +49 (0)202 40 45 145; Fax: +49 (0)202 40 45 158 or per E-Mail at: torqueservice@wera.de.



Series Click-Torque

Adjustable torque wrenches

Click-Torque A 5 torque wrench with reversible ratchet

















Application: For clockwise torque-control

Precision: ± 4% of set value, as per DIN EN ISO 6789-1: 2017-07

Design: With ¼" square drive, reversible ratchet, 45 teeth; easy setting and saving of the desired torque value, with audible and tactile locking when the scale values are reached (fine scale only in Newton meters), audible and tactile release mechanism when the set torque value is reached

Handle: Ergonomic 2-component handle

| | | | | | | | | | | | | | | |
|---|---|---|---|---|---|---|---|---|---|---|---|---|---|---|
|  |  |  |  |  |  |  |  |  |  |  |  |  |  |  |
| | Nm | Nm | lbf. ft. | mm | mm | mm | mm | mm | mm | mm | mm | mm | mm | mm |
| 05075604001 | 1/4" | 2,5-25 | 0,10 | 1-18 | 290 | 121 | 42 | 25 | 11,5 | 11 27/64" | 4 49/64" | 1 21/32" | 1" | 7/16" |

Click-Torque A 6 torque wrench with reversible ratchet

















Application: For clockwise torque-control

Precision: ± 4% of set value, as per DIN EN ISO 6789-1: 2017-07

Design: With ¼" hex drive, reversible ratchet, 45 teeth; easy setting and saving of the desired torque value, with audible and tactile locking when the scale values are reached (fine scale only in Newton meters), audible and tactile release mechanism when the set torque value is reached

Handle: Ergonomic 2-component handle

| | | | | | | | | | | | | | | |
|---|---|---|---|---|---|---|---|---|---|---|---|---|---|---|
|  |  |  |  |  |  |  |  |  |  |  |  |  |  |  |
| | Nm | Nm | lbf. ft. | mm | mm | mm | mm | mm | mm | mm | mm | mm | mm | mm |
| 05075605001 | 1/4" | 2,5-25 | 0,10 | 1-18 | 290 | 121 | 42 | 25 | 11,5 | 11 27/64" | 4 49/64" | 1 21/32" | 1" | 7/16" |



Series Click-Torque

Adjustable torque wrenches

Click-Torque B 1 torque wrench with reversible ratchet



Application: For clockwise torque-control

Precision: ± 3% of set value, as per DIN EN ISO 6789-1: 2017-07

Design: With $\frac{3}{8}$ " square drive, reversible ratchet, 45 teeth; easy setting and saving of the desired torque value, with audible and tactile locking when the scale values are reached (fine scale only in Newton meters), audible and tactile release mechanism when the set torque value is reached

Handle: Ergonomic 2-component handle

| | | Nm | Nm | lbf. ft. | mm | mm | mm | mm | mm | mm | mm | mm | mm | mm |
|-------------|-----------------|-------|------|----------|-----|-----|----|----|------|----------------------|---------------------|---------------------|-------------------|-----------------|
| 05075610001 | $\frac{3}{8}$ " | 10-50 | 0,25 | 8-36 | 360 | 140 | 47 | 35 | 16,5 | 14 $\frac{11}{64}$ " | 5 $\frac{33}{64}$ " | 1 $\frac{27}{32}$ " | 1 $\frac{3}{8}$ " | $\frac{5}{8}$ " |

Click-Torque B 2 torque wrench with reversible ratchet



Application: For clockwise torque-control

Precision: ± 3% of set value, as per DIN EN ISO 6789-1: 2017-07

Design: With $\frac{3}{8}$ " square drive, reversible ratchet, 45 teeth; easy setting and saving of the desired torque value, with audible and tactile locking when the scale values are reached (fine scale only in Newton meters), audible and tactile release mechanism when the set torque value is reached

Handle: Ergonomic 2-component handle

| | | Nm | Nm | lbf. ft. | mm | mm | mm | mm | mm | mm | mm | mm | mm | mm |
|-------------|-----------------|--------|-----|----------|-----|-----|----|----|------|----------------------|---------------------|---------------------|---------------------|-------------------|
| 05075611001 | $\frac{3}{8}$ " | 20-100 | 0,5 | 15-73 | 405 | 140 | 47 | 43 | 18,5 | 15 $\frac{15}{16}$ " | 5 $\frac{33}{64}$ " | 1 $\frac{27}{32}$ " | 1 $\frac{11}{16}$ " | $\frac{45}{64}$ " |

Click-Torque C 1 torque wrench with reversible ratchet



Application: For clockwise torque-control

Precision: ± 3% of set value, as per DIN EN ISO 6789-1: 2017-07

Design: With 1/2" square drive, reversible ratchet, 45 teeth; easy setting and saving of the desired torque value, with audible and tactile locking when the scale values are reached (fine scale only in Newton meters), audible and tactile release mechanism when the set torque value is reached

Handle: Ergonomic 2-component handle

| | | Nm | Nm | lbf. ft. | mm | mm | mm | mm | mm | mm | mm | mm | mm | mm |
|-------------|------|-------|------|----------|-----|-----|----|----|------|-----------|----------|----------|--------|------|
| 05075620001 | 1/2" | 10-50 | 0,25 | 8-36 | 360 | 140 | 47 | 35 | 16,5 | 14 11/64" | 5 33/64" | 1 27/32" | 1 3/8" | 5/8" |

Click-Torque C 2 torque wrench with reversible ratchet



Application: For clockwise torque-control

Precision: ± 3% of set value, as per DIN EN ISO 6789-1: 2017-07

Design: With 1/2" square drive, reversible ratchet, 45 teeth; easy setting and saving of the desired torque value, with audible and tactile locking when the scale values are reached (fine scale only in Newton meters), audible and tactile release mechanism when the set torque value is reached

Handle: Ergonomic 2-component handle

| | | Nm | Nm | lbf. ft. | mm | mm | mm | mm | mm | mm | mm | mm | mm | mm |
|-------------|------|--------|-----|----------|-----|-----|----|----|------|-----------|----------|----------|----------|--------|
| 05075621001 | 1/2" | 20-100 | 0,5 | 15-73 | 405 | 140 | 47 | 43 | 18,5 | 15 15/16" | 5 33/64" | 1 27/32" | 1 11/16" | 45/64" |



Series Click-Torque

Adjustable torque wrenches

Click-Torque C 3 torque wrench with reversible ratchet



Application: For clockwise torque-control

Precision: ± 3% of set value, as per DIN EN ISO 6789-1: 2017-07

Design: With 1/2" square drive, reversible ratchet, 45 teeth; easy setting and saving of the desired torque value, with audible and tactile locking when the scale values are reached (fine scale only in Newton meters), audible and tactile release mechanism when the set torque value is reached

Handle: Ergonomic 2-component handle

| | | Nm | Nm | lbf. ft. | mm | mm | mm | mm | mm | mm | mm | mm | mm | mm |
|-------------|------|--------|-----|----------|-----|-----|----|----|------|----------|----------|----------|----------|--------|
| 05075622001 | 1/2" | 40-200 | 1,0 | 30-146 | 510 | 140 | 47 | 43 | 18,5 | 20 5/64" | 5 33/64" | 1 27/32" | 1 11/16" | 45/64" |

Click-Torque C 4 torque wrench with reversible ratchet



Application: For clockwise torque-control

Precision: ± 3% of set value, as per DIN EN ISO 6789-1: 2017-07

Design: With 1/2" square drive, reversible ratchet, 45 teeth; easy setting and saving of the desired torque value, with audible and tactile locking when the scale values are reached (fine scale only in Newton meters), audible and tactile release mechanism when the set torque value is reached

Handle: Ergonomic 2-component handle

| | | Nm | Nm | lbf. ft. | mm | mm | mm | mm | mm | mm | mm | mm | mm | mm |
|-------------|------|--------|-----|----------|-----|-----|----|----|------|-----------|----------|----------|----------|--------|
| 05075623001 | 1/2" | 60-300 | 1,0 | 45-220 | 595 | 140 | 47 | 43 | 18,5 | 23 27/64" | 5 33/64" | 1 27/32" | 1 11/16" | 45/64" |

Click-Torque C 5 torque wrench with reversible ratchet



Application: For clockwise torque-control

Precision: Accuracy ± 3% of set value, as per DIN EN ISO 6789-1: 2017-07; application range with up to max. 400 Nm above standard
DIN EN ISO 6789-1: 2017-07 (maximum value: 340 Nm)

Design: With 1/2" square drive, reversible ratchet, 45 teeth; easy setting and saving of the desired torque value, with audible and tactile locking when the scale values are reached (fine scale only in Newton meters), audible and tactile release mechanism when the set torque value is reached

Handle: Ergonomic 2-component handle

| | | | | | | | | | | | | | | | |
|-------------|------|--------|-----|----------|-----|-----|----|----|------|-----------|----------|----------|----------|--------|----|
| | | | | | | | | | | | | | | | |
| | | Nm | Nm | lbf. ft. | mm | mm | mm | mm | mm | mm | mm | mm | mm | mm | mm |
| 05075624001 | 1/2" | 80-400 | 1,0 | 60-295 | 680 | 140 | 47 | 43 | 18,5 | 26 49/64" | 5 33/64" | 1 27/32" | 1 11/16" | 45/64" | |

¹ available from September 2018

Click-Torque E 1 torque wrench with reversible ratchet



Application: For clockwise torque-control

Precision: ± 3% of set value, as per DIN EN ISO 6789-1: 2017-07

Design: With 3/4" square drive, reversible ratchet, 45 teeth; easy setting and saving of the desired torque value, with audible and tactile locking when the scale values are reached (fine scale only in Newton meters), audible and tactile release mechanism when the set torque value is reached

Handle: Ergonomic 2-component handle

| | | | | | | | | | | | | | | | |
|-------------|------|----------|-----|----------|------|-----|----|----|----|----------|----------|----------|----------|---------|----|
| | | | | | | | | | | | | | | | |
| | | Nm | Nm | lbf. ft. | mm | mm | mm | mm | mm | mm | mm | mm | mm | mm | mm |
| 05075630001 | 3/4" | 200-1000 | 1,0 | 148-737 | 1250 | 140 | 47 | 63 | 30 | 49 7/32" | 5 33/64" | 1 27/32" | 2 31/64" | 1 3/16" | |

¹ available from January 2019



Series Click-Torque

Adjustable torque wrenches

Click-Torque X 1 torque wrench for insert tools

















Application: For right and left-handed use

Precision: ± 4% of set value, as per DIN EN ISO 6789-1: 2017-07

Design: For 9x12 mm interchangeable insert tools; easy setting and saving of the desired torque value, with audible and tactile locking when the scale values are reached (fine scale only in Newton meters), audible and tactile release mechanism when the set torque value is reached

Handle: Ergonomic 2-component handle

| |  |  |  |  |  |  |  |  |  |  |  |  |  |  |
|-------------|---|---|---|---|---|---|---|---|---|---|---|---|--|---|
| | | Nm | Nm | lbf. ft. | mm | mm | mm | mm | mm | mm | mm | mm | mm | mm |
| 05075651001 | 9x12 | 2,5-25 | 0,10 | 4-18 | 283 | 121 | 42 | 24 | 20 | 11 ⁹ / ₆₄ " | 4 ⁴⁹ / ₆₄ " | 1 ²¹ / ₃₂ " | 15/ ₁₆ " | 25/ ₃₂ " |

Click-Torque X 2 torque wrench for insert tools

















Application: For right and left-handed use

Precision: ± 3% of set value, as per DIN EN ISO 6789-1: 2017-07

Design: For 9x12 mm interchangeable insert tools; easy setting and saving of the desired torque value, with audible and tactile locking when the scale values are reached (fine scale only in Newton meters), audible and tactile release mechanism when the set torque value is reached

Handle: Ergonomic 2-component handle

| |  |  |  |  |  |  |  |  |  |  |  |  |  |  |
|-------------|---|---|---|---|---|---|---|---|---|---|---|---|--|---|
| | | Nm | Nm | lbf. ft. | mm | mm | mm | mm | mm | mm | mm | mm | mm | mm |
| 05075652001 | 9x12 | 10-50 | 0,25 | 8-36 | 338 | 140 | 47 | 29 | 20 | 13 ⁵ / ₁₆ " | 5 ³³ / ₆₄ " | 1 ²⁷ / ₃₂ " | 1 ⁹ / ₆₄ " | 25/ ₃₂ " |

Click-Torque X 3 torque wrench for insert tools



- Application:** For right and left-handed use
- Precision:** ± 3% of set value, as per DIN EN ISO 6789-1: 2017-07
- Design:** For 9x12 mm interchangeable insert tools; easy setting and saving of the desired torque value, with audible and tactile locking when the scale values are reached (fine scale only in Newton meters), audible and tactile release mechanism when the set torque value is reached
- Handle:** Ergonomic 2-component handle

| | |
|-------------|---|
| | |
| 05075653001 | 9x12 20-100 0,5 15-73 372 140 47 29 20 14 ⁴¹ / ₆₄ " 5 ³³ / ₆₄ " 1 ²⁷ / ₃₂ " 1 ⁹ / ₆₄ " 25 ²⁵ / ₃₂ " |

Click-Torque X 4 torque wrench for insert tools



- Application:** For right and left-handed use
- Precision:** ± 3% of set value, as per DIN EN ISO 6789-1: 2017-07
- Design:** For 14x18 mm interchangeable insert tools; easy setting and saving of the desired torque value, with audible and tactile locking when the scale values are reached (fine scale only in Newton meters), audible and tactile release mechanism when the set torque value is reached
- Handle:** Ergonomic 2-component handle

| | |
|-------------|--|
| | |
| 05075654001 | 14x18 40-200 1,0 30-146 480 140 47 32 26 18 ⁵⁷ / ₆₄ " 5 ³³ / ₆₄ " 1 ²⁷ / ₃₂ " 1 ¹⁷ / ₆₄ " 1 ¹ / ₃₂ " |



Series Click-Torque

Adjustable torque wrenches

Click-Torque X 5 torque wrench for insert tools



Application: For right and left-handed use

Precision: ± 3% of set value, as per DIN EN ISO 6789-1: 2017-07

Design: For 14x18 mm interchangeable insert tools; easy setting and saving of the desired torque value, with audible and tactile locking when the scale values are reached (fine scale only in Newton meters), audible and tactile release mechanism when the set torque value is reached

Handle: Ergonomic 2-component handle

| | | | | | | | | | | | | | | |
|-------------|-------|--------|-----|----------|-----|-----|----|----|----|----------|----------|----------|----------|---------|
| | | | | | | | | | | | | | | |
| | | Nm | Nm | lbf. ft. | mm | mm | mm | mm | mm | mm | mm | mm | mm | mm |
| 05075655001 | 14x18 | 60-300 | 1,0 | 45-220 | 570 | 140 | 47 | 32 | 26 | 22 7/16" | 5 33/64" | 1 27/32" | 1 17/64" | 1 1/32" |

Click-Torque X 6 torque wrench for insert tools



Application: For right and left-handed use

Precision: ± 3% of set value, as per DIN EN ISO 6789-1: 2017-07; application range with up to max. 400 Nm above standard DIN EN ISO 6789-1: 2017-07 (maximum value: 340 Nm)

Design: For 14x18 mm interchangeable insert tools; easy setting and saving of the desired torque value, with audible and tactile locking when the scale values are reached (fine scale only in Newton meters), audible and tactile release mechanism when the set torque value is reached

Handle: Ergonomic 2-component handle

| | | | | | | | | | | | | | | |
|-------------|-------|--------|-----|----------|-----|-----|----|----|----|-----------|----------|----------|----------|---------|
| | | | | | | | | | | | | | | |
| | | Nm | Nm | lbf. ft. | mm | mm | mm | mm | mm | mm | mm | mm | mm | mm |
| 05075656001 | 14x18 | 80-400 | 1,0 | 60-295 | 655 | 140 | 47 | 32 | 26 | 25 25/32" | 5 33/64" | 1 27/32" | 1 17/64" | 1 1/32" |

⁷ available from September 2018



40-200 N·m
30-140 lb·ft



Series Insert Tools

Suitable for Series Click-Torque X torque wrenches.

7770 Open end insert

Form A

05078600001
05078601001
05078602001
05078603001
05078604001
05078605001







Form B

05078606001
05078607001
05078608001
05078609001
05078610001
05078611001
05078612001



Application: Hexagon screw heads or nuts
Drive: 9x12 mm; for torque wrenches of the Click-Torque X series with 9x12 mm holder
Design: Forged, chrome vanadium steel, matt chrome plated; with safety pin

| |  |  |  |  |  |
|-------------|---|---|---|---|---|
| | mm | mm | mm | mm | mm |
| 05078600001 | 7 | 39,0 | 22,0 | 22,0 | 5,0 |
| 05078601001 | 8 | 39,0 | 22,0 | 22,0 | 5,0 |
| 05078602001 | 9 | 39,0 | 22,0 | 22,0 | 5,0 |
| 05078603001 | 10 | 39,0 | 22,0 | 22,0 | 5,0 |
| 05078604001 | 11 | 39,0 | 22,0 | 22,0 | 5,0 |
| 05078605001 | 12 | 39,0 | 22,0 | 22,0 | 5,0 |
| 05078606001 | 13 | 41,0 | 24,0 | 30,0 | 7,0 |
| 05078607001 | 14 | 41,0 | 24,0 | 30,0 | 7,0 |
| 05078608001 | 15 | 41,0 | 24,0 | 30,0 | 7,0 |
| 05078609001 | 16 | 41,0 | 24,0 | 30,0 | 7,0 |
| 05078610001 | 17 | 41,0 | 24,0 | 30,0 | 7,0 |
| 05078611001 | 18 | 41,0 | 24,0 | 30,0 | 7,0 |
| 05078612001 | 19 | 41,0 | 24,0 | 30,0 | 7,0 |

7780 Open end insert

Form A

05078670001



Form B

05078671001
05078672001
05078673001
05078674001
05078675001
05078676001



Form C

05078677001
05078678001
05078679001
05078680001
05078681001







Form D

05078682001
05078683001
05078684001
05078685001
05078686001
05078687001



Application: Hexagon screw heads or nuts
Drive: 14x18 mm; for torque wrenches of the Click-Torque X series with 14x18 mm holder
Design: Forged, chrome vanadium steel, matt chrome plated; with safety pin

| |  |  |  |  |  |
|-------------|--|---|---|---|---|
| | mm | mm | mm | mm | mm |
| 05078670001 | 13 | 56,0 | 32,0 | 30,0 | 7,0 |
| 05078671001 | 14 | 58,0 | 33,0 | 32,0 | 7,0 |
| 05078672001 | 15 | 58,0 | 33,0 | 32,0 | 7,0 |
| 05078673001 | 16 | 58,0 | 33,0 | 32,0 | 7,0 |
| 05078674001 | 17 | 58,0 | 33,0 | 32,0 | 7,0 |
| 05078675001 | 18 | 58,0 | 33,0 | 32,0 | 7,0 |
| 05078676001 | 19 | 58,0 | 33,0 | 32,0 | 7,0 |
| 05078677001 | 21 | 61,0 | 36,0 | 52,0 | 12,0 |
| 05078678001 | 22 | 61,0 | 36,0 | 52,0 | 12,0 |
| 05078679001 | 24 | 61,0 | 36,0 | 52,0 | 12,0 |
| 05078680001 | 26 | 61,0 | 36,0 | 52,0 | 12,0 |
| 05078681001 | 27 | 61,0 | 36,0 | 52,0 | 12,0 |
| 05078682001 | 29 | 61,0 | 36,0 | 52,0 | 12,0 |
| 05078683001 | 30 | 61,0 | 36,0 | 52,0 | 12,0 |
| 05078684001 | 32 | 61,0 | 36,0 | 52,0 | 12,0 |
| 05078685001 | 36 | 61,0 | 36,0 | 52,0 | 12,0 |
| 05078686001 | 38 | 61,0 | 36,0 | 52,0 | 12,0 |
| 05078687001 | 41 | 61,0 | 36,0 | 52,0 | 12,0 |

7771 Ring spanner insert

Form A

05078620001
05078621001
05078622001
05078623001
05078624001



Form B

05078625001
05078626001
05078627001
05078628001
05078629001
05078630001
05078631001
05078632001



Form C





05078633001



Application: Hexagon screw heads or nuts

Drive: 9x12 mm; for torque wrenches of the Click-Torque X series with 9x12 mm holder

Design: Forged, chrome vanadium steel, matt chrome plated; with safety pin

| |  |  |  |  |  |
|-------------|---|---|---|---|---|
| | mm | mm | mm | mm | mm |
| 05078620001 | 7 | 41,0 | 24,0 | 22,0 | 8,0 |
| 05078621001 | 8 | 41,0 | 24,0 | 22,0 | 8,0 |
| 05078622001 | 9 | 41,0 | 24,0 | 22,0 | 8,0 |
| 05078623001 | 10 | 41,0 | 24,0 | 22,0 | 8,0 |
| 05078624001 | 11 | 41,0 | 24,0 | 22,0 | 8,0 |
| 05078625001 | 12 | 44,0 | 27,0 | 22,0 | 11,0 |
| 05078626001 | 13 | 44,0 | 27,0 | 22,0 | 11,0 |
| 05078627001 | 14 | 44,0 | 27,0 | 22,0 | 11,0 |
| 05078628001 | 15 | 44,0 | 27,0 | 22,0 | 11,0 |
| 05078629001 | 16 | 44,0 | 27,0 | 22,0 | 11,0 |
| 05078630001 | 17 | 44,0 | 27,0 | 22,0 | 11,0 |
| 05078631001 | 18 | 44,0 | 27,0 | 22,0 | 11,0 |
| 05078632001 | 19 | 44,0 | 27,0 | 22,0 | 11,0 |
| 05078633001 | 21 | 51,0 | 34,0 | 33,0 | 15,0 |

7781 Ring spanner insert

Form A

05078690001
05078691001
05078692001



Form B

05078693001
05078694001
05078695001
05078696001
05078697001
05078698001
05078699001



Form C





05078700001
05078701001
05078702001
05078703001
05078704001
05078705001



Application: Hexagon screw heads or nuts

Drive: 14x18 mm; for torque wrenches of the Click-Torque X series with 14x18 mm holder

Design: Forged, chrome vanadium steel, matt chrome plated; with safety pin

| |  |  |  |  |  |
|-------------|---|---|---|---|---|
| | mm | mm | mm | mm | mm |
| 05078690001 | 13 | 62,0 | 37,0 | 30,0 | 11,0 |
| 05078691001 | 14 | 62,0 | 37,0 | 30,0 | 11,0 |
| 05078692001 | 15 | 62,0 | 37,0 | 30,0 | 11,0 |
| 05078693001 | 16 | 64,0 | 39,0 | 28,0 | 12,0 |
| 05078694001 | 17 | 64,0 | 39,0 | 28,0 | 12,0 |
| 05078695001 | 18 | 64,0 | 39,0 | 28,0 | 12,0 |
| 05078696001 | 19 | 64,0 | 39,0 | 28,0 | 12,0 |
| 05078697001 | 21 | 64,0 | 39,0 | 28,0 | 12,0 |
| 05078698001 | 22 | 64,0 | 39,0 | 28,0 | 12,0 |
| 05078699001 | 24 | 64,0 | 39,0 | 28,0 | 12,0 |
| 05078700001 | 27 | 81,0 | 56,0 | 53,0 | 21,0 |
| 05078701001 | 30 | 81,0 | 56,0 | 53,0 | 21,0 |
| 05078702001 | 32 | 81,0 | 56,0 | 53,0 | 21,0 |
| 05078703001 | 34 | 81,0 | 56,0 | 53,0 | 21,0 |
| 05078704001 | 36 | 81,0 | 56,0 | 53,0 | 21,0 |
| 05078705001 | 41 | 81,0 | 56,0 | 53,0 | 21,0 |

Series Insert Tools

Suitable for Series Click-Torque X torque wrenches.

7772 A Ratchet insert, reversible



Application: For 1/4" square socket wrench inserts and 1/4" connecting parts with square drive

Drive: 9x12 mm; for torque wrenches of the Click-Torque X series with 9x12 mm holder

Design: With reversing ratchet, push-button release, forged, chrome-vanadium steel, matt chrome-plated; with safety pin

| | | mm | mm | mm | mm |
|-------------|------|------|------|------|------|
| 05078635001 | 1/4" | 49,0 | 32,0 | 28,0 | 15,0 |

7772 B Ratchet insert, reversible



Application: For 3/8" square socket wrench inserts and 3/8" connecting parts with square drive

Drive: 9x12 mm; for torque wrenches of the Click-Torque X series with 9x12 mm holder

Design: With reversing ratchet, push-button release, forged, chrome-vanadium steel, matt chrome-plated; with safety pin

| | | mm | mm | mm | mm |
|-------------|------|------|------|------|------|
| 05078636001 | 3/8" | 52,0 | 35,0 | 35,0 | 21,0 |

7772 C Ratchet insert, reversible



Application: For 1/2" square socket wrench inserts and 1/2" connecting parts with square drive

Drive: 9x12 mm; for torque wrenches of the Click-Torque X series with 9x12 mm holder

Design: With reversing ratchet, push-button release, forged, chrome-vanadium steel, matt chrome-plated; with safety pin

| | | mm | mm | mm | mm |
|-------------|------|------|------|------|------|
| 05078637001 | 1/2" | 58,0 | 41,0 | 42,0 | 23,0 |

7782 E Ratchet insert, reversible



Application: For 3/4" square socket wrench inserts and 3/4" connecting parts with square drive

Drive: 14x18 mm; for torque wrenches of the Click-Torque X series with 14x18 mm holder

Design: With reversing ratchet, push-button release, forged, chrome-vanadium steel, matt chrome-plated; with safety pin

| | | mm | mm | mm | mm |
|-------------|------|------|------|------|------|
| 05078708001 | 3/4" | 90,0 | 65,0 | 65,0 | 36,0 |

7782 C Ratchet insert, reversible



Application: For 1/2" square socket wrench inserts and 1/2" connecting parts with square drive

Drive: 14x18 mm; for torque wrenches of the Click-Torque X series with 14x18 mm holder

Design: With reversing ratchet, push-button release, forged, chrome-vanadium steel, matt chrome-plated; with safety pin

| | | mm | mm | mm | mm |
|-------------|------|------|------|------|------|
| 05078707001 | 1/2" | 66,0 | 41,0 | 42,0 | 23,0 |

7773 A Square drive insert



Application: For 1/4" square socket wrench inserts and 1/4" connecting parts with square drive

Drive: 9x12 mm; for torque wrenches of the Click-Torque X series with 9x12 mm holder

Design: Forged, chrome-vanadium steel, matt chrome-plated; with safety pin

| | | mm | mm | mm | mm |
|-------------|------|------|------|------|------|
| 05078200001 | 1/4" | 44,0 | 28,0 | 21,0 | 14,0 |

7773 B Square drive insert



Application: For $\frac{3}{8}$ " square socket wrench inserts and $\frac{3}{8}$ " connecting parts with square drive

Drive: 9x12 mm; for torque wrenches of the Click-Torque X series with 9x12 mm holder

Design: Forged, chrome-vanadium steel, matt chrome-plated; with safety pin

| | | | | | |
|-------------|-----------------|------|------|------|------|
| | | | | | |
| | | mm | mm | | |
| 05078205001 | $\frac{3}{8}$ " | 44,0 | 28,0 | 21,0 | 14,0 |

7783 C Square drive insert



Application: For $\frac{1}{2}$ " square socket wrench inserts and $\frac{1}{2}$ " connecting parts with square drive

Drive: 14x18 mm; for torque wrenches of the Click-Torque X series with 14x18 mm holder

Design: Forged, chrome-vanadium steel, matt chrome-plated; with safety pin

| | | | | | |
|-------------|-----------------|------|------|------|------|
| | | | | | |
| | | mm | mm | | |
| 05078345001 | $\frac{1}{2}$ " | 65,0 | 40,0 | 30,0 | 18,0 |

7773 C Square drive insert



Application: For $\frac{1}{2}$ " square socket wrench inserts and $\frac{1}{2}$ " connecting parts with square drive

Drive: 9x12 mm; for torque wrenches of the Click-Torque X series with 9x12 mm holder

Design: Forged, chrome-vanadium steel, matt chrome-plated; with safety pin

| | | | | | |
|-------------|-----------------|------|------|------|------|
| | | | | | |
| | | mm | mm | mm | mm |
| 05078210001 | $\frac{1}{2}$ " | 44,0 | 28,0 | 21,0 | 14,0 |

7774/1 Bit adapter insert, $\frac{1}{4}$ "



Application: Suitable for $\frac{1}{4}$ " DIN ISO 1173-C 6,3 hexagon insert bits and Wera Series 1

Drive: 9x12 mm; for torque wrenches of the Click-Torque X series with 9x12 mm holder

Design: Forged, chrome-vanadium steel, matt chrome-plated; with safety pin

| | | | | | |
|-------------|-----------------|------|------|------|------|
| | | | | | |
| | | mm | mm | mm | mm |
| 05078640001 | $\frac{1}{4}$ " | 42,0 | 25,0 | 22,0 | 12,5 |

7783 E Push-through square insert tool



Application: For $\frac{1}{2}$ " square socket wrench inserts and $\frac{3}{4}$ " connecting parts with square drive

Drive: 14x18 mm; for torque wrenches of the Click-Torque X series with 14x18 mm holder

Design: With push-through square with ball lock, forged, chrome-vanadium steel, matt chrome-plated; with safety pin

| | | | | | |
|-------------|-----------------|------|------|------|------|
| | | | | | |
| | | mm | mm | mm | mm |
| 05078710001 | $\frac{3}{4}$ " | 70,0 | 45,0 | 40,0 | 25,0 |

7774/2 Bit adapter insert, $\frac{5}{16}$ "



Application: Suitable for $\frac{5}{16}$ " DIN ISO 1173-E 8 hexagon insert bits and Wera Series 2

Drive: 9x12 mm; for torque wrenches of the Click-Torque X series with 9x12 mm holder

Design: Forged, chrome-vanadium steel, matt chrome-plated; with safety pin

| | | | | | |
|-------------|------------------|------|------|------|------|
| | | | | | |
| | | mm | mm | mm | mm |
| 05078641001 | $\frac{5}{16}$ " | 42,0 | 25,0 | 22,0 | 12,5 |

Series Insert Tools

Suitable for Series Click-Torque X torque wrenches.





7774/3 Bit adapter insert, 5/16" "



Application: Suitable for 5/16" DIN ISO 1173-E 8 hexagon insert bits and Wera Series 2

Drive: 14x18 mm; for torque wrenches of the Click-Torque X series with 14x18 mm holder

Design: Forged, chrome-vanadium steel, matt chrome-plated; with safety pin

| |  |  |  |  |  |
|-------------|---|---|---|---|---|
| | mm | mm | mm | mm | mm |
| 05078642001 | 5/16" | 58,0 | 33,0 | 30,0 | 13,0 |

7775 Open ring spanner insert

Form A

05078650001
05078651001
05078652001
05078653001
05078654001
05078655001



Form B





05078656001
05078657001
05078658001



Application: Hexagon screw heads or nuts

Drive: 9x12 mm; for torque wrenches of the Click-Torque X series with 9x12 mm holder

Design: Forged, chrome vanadium steel, matt chrome plated; with safety pin

| |  |  |  |  |  |
|-------------|---|---|---|---|---|
| | mm | mm | mm | mm | mm |
| 05078650001 | 10 | 44,0 | 27,0 | 22,0 | 11,0 |
| 05078651001 | 11 | 44,0 | 27,0 | 22,0 | 11,0 |
| 05078652001 | 12 | 44,0 | 27,0 | 22,0 | 11,0 |
| 05078653001 | 13 | 44,0 | 27,0 | 22,0 | 11,0 |
| 05078654001 | 14 | 44,0 | 27,0 | 22,0 | 11,0 |
| 05078655001 | 17 | 44,0 | 27,0 | 22,0 | 11,0 |
| 05078656001 | 18 | 49,0 | 32,0 | 33,0 | 15,0 |
| 05078657001 | 19 | 49,0 | 32,0 | 33,0 | 15,0 |
| 05078658001 | 22 | 49,0 | 32,0 | 33,0 | 15,0 |

7776 External TORX® insert

Form A

05078660001
05078661001
05078662001
05078663001



Form B





05078664001



Application: External TORX® screws

Drive: 9x12 mm; for torque wrenches of the Click-Torque X series with 9x12 mm holder

Design: Forged, chrome-vanadium steel, matt chrome-plated; with safety pin

| |  |  |  |  |  |
|-------------|---|---|---|---|---|
| | mm | mm | mm | mm | mm |
| 05078660001 | TX 6 | 40,0 | 23,0 | 22,0 | 8,0 |
| 05078661001 | TX 8 | 40,0 | 23,0 | 22,0 | 8,0 |
| 05078662001 | TX 10 | 40,0 | 23,0 | 22,0 | 8,0 |
| 05078663001 | TX 12 | 40,0 | 23,0 | 22,0 | 8,0 |
| 05078664001 | TX 14 | 45,0 | 28,0 | 22,0 | 11,0 |

7786 External TORX® insert

Form A

05078714001
05078715001



Form B





05078716001
05078717001



Application: External TORX® screws

Drive: 14x18 mm; for torque wrenches of the Click-Torque X series with 14x18 mm holder







Design: Forged, chrome-vanadium steel, matt chrome-plated; with safety pin

| |  |  |  |  |  |
|-------------|---|---|---|---|---|
| | mm | mm | mm | mm | mm |
| 05078714001 | TX 14 | 37,0 | 62,0 | 30,0 | 11,0 |
| 05078715001 | TX 18 | 37,0 | 62,0 | 30,0 | 11,0 |
| 05078716001 | TX 20 | 40,0 | 65,0 | 32,0 | 12,0 |
| 05078717001 | TX 24 | 40,0 | 65,0 | 32,0 | 12,0 |

7779/1 Adapter insert









- Application:** For the use of square plug-in tools 14x18 mm in torque wrenches with internal square 9x12 mm
- Drive:** 9x12 mm; for torque wrenches of the Click-Torque X series with 9x12 mm holder
- Design:** Forged, chrome vanadium steel, matt chrome plated; with safety pin

| |  |  |  |  |  |  |
|-------------|---|---|---|---|---|---|
| | mm | mm | mm | mm | mm | mm |
| 05078666001 | 14x18 | 9x12 | 49,0 | 33,0 | 32,0 | 26,0 |

7779/2 Adapter insert







- Application:** For the use of square plug-in tools 9x12 mm in torque wrenches with internal square 14x18 mm
- Drive:** 14x18 mm; for torque wrenches of the Click-Torque X series with 14x18 mm holder
- Design:** Forged, chrome vanadium steel, matt chrome plated; with safety pin

| |  |  |  |  |  |  |
|-------------|---|---|---|---|---|---|
| | mm | mm | mm | mm | mm | mm |
| 05078667001 | 9x12 | 14x18 | 52,0 | 27,0 | 28,0 | 21,0 |

7790/1 Push-fit weld-on adapter









- Application:** For welding on specifically required tools
- Drive:** 9x12 mm; for torque wrenches of the Click-Torque X series with 9x12 mm holder
- Design:** Forged, phosphated, with safety pin

| |  |  |  |  |
|-------------|---|---|---|---|
| | mm | mm | mm | mm |
| 05078720001 | 24,0 | 8,0 | 22,0 | 14,0 |

7790/2 Push-fit weld-on adapter



- Application:** For welding on specifically required tools
- Drive:** 14x18 mm; for torque wrenches of the Click-Torque X series with 14x18 mm holder
- Design:** Forged, phosphated, with safety pin

| |  |  |  |  |  |
|-------------|---|---|---|---|---|
| | mm | mm | mm | mm |  |
| 05078721001 | 38,0 | 13,0 | 31,0 | 22,0 | 26,0 |





Impact Driver and Soft-faced Hammers



Impact Driver

510



Soft-faced Hammers

512



Impact driver

It has to be possible that even the most seized screw can be loosened.

Impact drivers are the solution whenever manual power is insufficient and a pneumatic screwdriver is not to hand.

The Wera impact driver has particularly high efficiency thanks to its robust double-curved design. Impact forces are converted into rotary motion and so there is no need for the use of pneumatic appliances.



Seized screws can be loosened or tightened without power tools.





The double-curved design is particularly efficient.



2090 Impact driver 90 Nm



Application: Screws M 4 - M 8
Output: $\frac{5}{16}$ " hexagon socket









| |  |  |
|-------------|---|---|
| | mm | |
| 05072014001 | 142,0 | 5 ¹⁹ / ₃₂ " |

2090/17 Impact driver set



17-piece set; in a surface-preserving, compact and extremely robust textile box; low volume and weight for simplified mobility

1x 2090 impact driver 90 Nm, $\frac{5}{16}$ " hexagon socket; 1 adaptor $\frac{5}{16}$ " external hexagon/ $\frac{3}{8}$ " external square, 1 adaptor $\frac{5}{16}$ " external hexagon/ $\frac{1}{2}$ " external square, 14 bits

|  | | |
|---|----------------------|--|
| 05072017001 | | |
| | 2090 90 Nm | 1 x 142,0 |
|  | 851/2 Z PH | 1 x PH 2x32; 1 x PH 3x32 |
|  | 851/2 PH | 1 x PH 4x32 |
|  | 800/2 | 1 x 2,0x12,0x41 |
|  | 840/2 Z | 1 x 5x30; 1 x 6x30; 1 x 8x30; 1 x 10x30 |
|  | 840/2 | 1 x 7,0x30 |
|  | 867/2 Z TORX® | 1 x TX 30x35; 1 x TX 40x35; 1 x TX 45x35; 1 x TX 50x35; 1 x TX 55x35 |
|  | 870/2 | 1 x 3/8"x5/16"; 1 x 1/2"x5/16" |



Soft-faced hammers

Powerful hammering with surface protection.



They come in soft, medium and hard designs for a wide range of applications from universal use to splinter-free applications on sharp-edged work pieces.

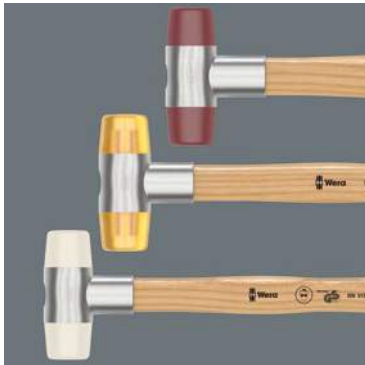

Powerful work is ensured with handles out of high quality ash wood.



Colour guidance system

- Yellow = Repair/maintenance work with high demands
- Red = Suitable for hammering sharp-edged work pieces; bodyshops, automotive, engineering
- White = Suitable for metal processing and removal of dents; tent, large building and exhibition stand construction



The double-sided conical design creates an unbreakable and secure link between the handle and head of the hammer.

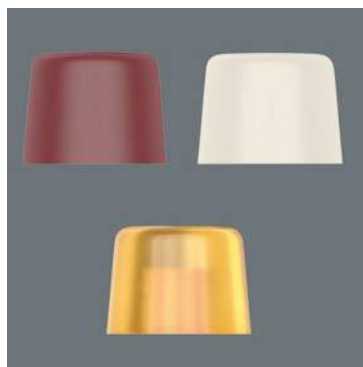

Versatile use thanks to the soft faced heads that can be retrospectively fitted.





Series Soft-Faced Hammers

Powerful hammering with surface protection



100 Soft-faced hammer with Cellidor head sections



Application: Demanding repair/maintenance work

Head: Cellidor, hard

Handle: Ashwood

| | # |  mm |  mm |  mm |
|-------------|---|--|--|--|
| 0500005001 | 1 | 22 | 75 | 250,0 |
| 05000010001 | 2 | 27 | 90 | 265,0 |
| 05000015001 | 3 | 32 | 95 | 280,0 |
| 05000020001 | 4 | 35 | 105 | 290,0 |
| 05000025001 | 5 | 40 | 110 | 320,0 |
| 05000030001 | 6 | 50 | 115 | 340,0 |
| 05000035001 | 7 | 60 | 135 | 380,0 |



101 Soft-faced hammer with nylon head sections



Application: Metal processing, removal of dents as well as tent, large building and exhibition stand construction

Head: Nylon, very hard

Handle: Ashwood

| | # |  mm |  mm |  mm |
|-------------|---|--|--|--|
| 05000305001 | 1 | 22 | 75 | 250,0 |
| 05000310001 | 2 | 27 | 90 | 265,0 |
| 05000315001 | 3 | 32 | 95 | 280,0 |
| 05000320001 | 4 | 35 | 105 | 290,0 |
| 05000325001 | 5 | 40 | 110 | 320,0 |
| 05000330001 | 6 | 50 | 115 | 340,0 |
| 05000335001 | 7 | 60 | 135 | 380,0 |



102 Soft-faced hammer with urethane head sections



Application: Bodyshops, automotive, engineering

Head: Urethane, medium-hard

Handle: Ashwood

| | # |  mm |  mm |  mm |
|-------------|---|--|--|--|
| 05000505001 | 1 | 22 | 75 | 250,0 |
| 05000510001 | 2 | 27 | 90 | 265,0 |
| 05000515001 | 3 | 32 | 95 | 280,0 |
| 05000520001 | 4 | 35 | 105 | 290,0 |
| 05000525001 | 5 | 40 | 110 | 320,0 |
| 05000530001 | 6 | 50 | 115 | 340,0 |
| 05000535001 | 7 | 60 | 135 | 380,0 |

100 S Replacement ashwood handles for hammers 100, 101, 102



| | # |  mm |
|-------------|---|--|
| 05000205001 | 1 | 250,0 |
| 05000210001 | 2 | 265,0 |
| 05000215001 | 3 | 280,0 |
| 05000220001 | 4 | 290,0 |
| 05000225001 | 5 | 320,0 |
| 05000230001 | 6 | 340,0 |
| 05000235001 | 7 | 380,0 |

100 L Replacement head sections out of Cellidor for hammer 100



Application: Demanding repair/maintenance work

| | # |  |
|-------------|---|---|
| 05000105001 | 1 | 22,0 |
| 05000110001 | 2 | 27,0 |
| 05000115001 | 3 | 32,0 |
| 05000120001 | 4 | 35,0 |
| 05000125001 | 5 | 40,0 |
| 05000130001 | 6 | 50,0 |
| 05000135001 | 7 | 60,0 |

101 L Replacement head sections out of nylon for hammer 101



Application: Metal processing, removal of dents as well as tent, large building and exhibition stand construction

| | # |  |
|-------------|---|---|
| 05000405001 | 1 | 22,0 |
| 05000410001 | 2 | 27,0 |
| 05000415001 | 3 | 32,0 |
| 05000420001 | 4 | 35,0 |
| 05000425001 | 5 | 40,0 |
| 05000430001 | 6 | 50,0 |
| 05000435001 | 7 | 60,0 |

102 L Replacement head sections out of urethane for hammer 102



Application: Bodyshops, automotive, engineering

| | # |  |
|-------------|---|---|
| 05000605001 | 1 | 22,0 |
| 05000610001 | 2 | 27,0 |
| 05000615001 | 3 | 32,0 |
| 05000620001 | 4 | 35,0 |
| 05000625001 | 5 | 40,0 |
| 05000630001 | 6 | 50,0 |
| 05000635001 | 7 | 60,0 |





TechLex - Technical data and information

| | |
|-------------------------------------|------------|
| Wera ABC | 518 |
| TORQUE Test Values | 522 |
| Dimensions Of Profiles | 523 |
| TORQUE Conversion Table | 524 |
| Conversion Of Inches To Millimeters | 525 |
| Code No. Index | 526 |
| Article No. Index | 540 |
| Alphabetical Index | 551 |

Wera ABC

Bit-Check

We have had bit ranges in our programme for many years now. In 2016, we put a question mark against everything and came up with a game changer. We wanted bit ranges with bits whose profiles and sizes could be more easily recognised. We wanted bit ranges that were as compact as possible and which were Wera-like at a first glance. We wanted bit ranges with bits that could be removed and reinserted more easily. We wanted bit ranges with as little weight as possible. The new multi-component Bit-Checks satisfy these requirements; the soft material in the lower section of the Bit-Checks ensures that the bits are firmly held yet easy to remove.

BiTorsion

BiTorsion bits have a tempered torsion zone that diverts the kinetic energy of peak loads away from the drive tip. This greatly reduces the risk of breakage and significantly extends the tools' service life. To find these bits in the catalogue look for the letter B after the article number. BiTorsion holders have a torsion zone that diverts the kinetic energy of peak loads away from the drive tip. The combined use of both the BiTorsion bit and holder increases the service life of the tools considerably and thus ensures higher productivity. BiTorsion bits and holders can, however, be used independently of each other and with conventional tools.

Bits, diamond coated

Please see -> diamond coated bits

Bits, extra hard

Please see -> extra hard bits

Bits, titanium nitride coated

Please see -> Titanium nitride coated bits

Bits, tough absorbing

Please see -> tough absorbing bits

BlackLaser

BlackLaser hardened blades for excellent surface protection and a long service life. High corrosion protection.

Black Point Tip

The Wera Black Point tip and a refined hardening process guarantee a long service life and increased corrosion protection.

Click-Torque Wrenches

Click-Torque wrenches in the unmistakable, robust Wera design with high accuracy as per DIN EN ISO 6789-1: 2017-07.

Chiseldriver

The chiseldriver is the solution for jobs that require more than just screwdriving. For fastening, chiselling and loosening seized screws or hose clamps. With an integrated impact cap that extends service life and reduces the risk of splintering. With a pound-thru hexagon blade made from high-grade material for zero-loss transfer of high forces when struck with a hammer. The tough viscous tempered material prevents the blade from splintering or breaking. More TORQUE can be transferred by attaching an open-jawed or ring spanner to the integrated hexagon bolster.

Diamond coated bits

The minute diamond particles on the tip of the bit literally bite into the screw. The secure hold means that less contact pressure is required, which reduces the risk of slipping. To find diamond coated bits in the catalogue look for the letters DC after the article number.

Extra hard bits

Ideal for soft screwdriving. TORQUE increases continuously without any peaks during fastening until the head of the screw reaches the surface of the material. Extra hard bits are made from a special material that extends the tools' service life and reduces the risk of material breakage. To find these bits in the catalogue look for the letter H after the article number.

Flexible Lock System

All rigid Zyklop extensions are fitted with a freewheel sleeve which lets you tighten and loosen screws and bolts quickly and effectively. The premium extensions are also fitted with the flexible lock system. With this system activated, drive handles can be attached permanently to the extension, preventing slipping or accidental loss of the tool. When the system is deactivated the sockets can be attached as usual and changed in a flash.

Hex-Plus Profile

The problem with hexagon socket screws is the easily “rounded” screw recess. This is caused by the sharp edges of the tool pressing against the inside of the screw profile. Gradual wear eventually grinds and destroys the head of the screw. Wera’s Hex-Plus tools provide more contact surface inside the screw profile, which reduces the notching effect and ultimately the deformation of the screw. Hex-Plus tools can also transfer up to 20 % more TORQUE.

Impact bits

Impact bits are designed for use in powerful impact screwdrivers. Impact bits were specifically developed to withstand high power tool forces.

Individual Testing

Our VDE screwdrivers are tested for dielectric strength under a 10,000-volt load to make sure that their most important property, their insulation, has been adequately tested. Each individual Wera VDE screwdriver is subjected to this test to guarantee safe working up to 1,000 volts.

Joker wrenches

The Joker’s holding function means that nuts and bolts can be held in the jaw and easily positioned where they are needed. Fastening on to the thread can then be done quickly and safely, thanks to the innovative special stop-plate which holds the fastener. No more time-wasting searches for dropped nuts and bolts!

Koloss

The ratchet that can also be used officially as a hammer. The Koloss can be used as a reversible, heavy-duty, fine action ratchet that can withstand loads of at least 600 Nm.

Kraftform Handle

The Kraftform handle has been designed to fit snugly in your hand, making blisters and calluses a thing of the past even after long-term use. The hard materials used for the handle promote fast grip adjustments and prevent the skin from sticking to the handle. The softer, anti-slip zones facilitate zero-loss transfer of high forces. This is an unbeatable combination! Work is done with a flick of the wrist!

Kraftform Kompakt

Wera’s compact tools are suitable for manual or machine use. The type of operation often becomes clear only after you’ve arrived at the site. The compact handle/interchangeable blade system offers you mobility and flexibility. The sets come with a Kraftform handle, quick-release chuck and bits for manual and machine use. The handle/interchangeable blade system permits rapid tool changes for a wide range of applications. Tools can be stored and carried in a strong plastic box or a robust belt pouch so that they are always at hand. The sets of series 20 have hidden depths: a telescopic blade that retracts into the handle (which can also be removed and attached to a power tool as a bit holder) and an integrated bit magazine. Rapidaptor technology ensures rapid bit changes.

Kraftform Micro

The three-zone concept of Kraftform Micro screwdrivers reduces fastening times and the cost per screw connection. The hand support on the easy-turning cap and the fast-turning zone below the cap accelerate the screwdriving process. This makes time-consuming grip adjustments, which are required with conventional precision screwdrivers, unnecessary. The power zone has integrated soft zones near the tip of the blade to transfer high tightening or loosening forces without losing contact with the screw. The precision zone directly above the blade provides a better feel for the rotation angle during fine adjustment work. The Wera Black Point tip and a refined hardening process guarantee a long service life and increased corrosion protection.

Lasertip

Wera Lasertip screwdrivers have been microscopically roughened by a laser. This rough surface literally “bites” into the head of the screw. Accidental slipping becomes a thing of the past.

Low-temperature Impact Strength

VDE tools are often used under extreme conditions, such as very low temperatures. Safety must be guaranteed even under these conditions. The plastics used for the handle of Wera VDE screwdrivers are guaranteed to meet the more stringent test requirements for low-temperature impact strength at -40 °C.

Multi-component Screwdriver Handle

The Kraftform handle has been designed to fit snugly in your hand, making blisters and calluses a thing of the past even after long-term use. The hard materials used for the handle promote fast grip adjustments and prevent the skin from sticking to the handle. The softer, anti-slip zones facilitate zero-loss transfer of high forces. This is an unbeatable combination! Work is done with a flick of the wrist!

Wera ABC

Rapidaptor

Wera developed the Rapidaptor that allows you to change bits quickly with just one hand and without extra tools.

Rapid-in and self-lock

The bit can be pushed into the adaptor without moving the sleeve. The lock is activated automatically as soon as the bit is applied to the screw. Bits are held securely and wobble-free.

Rapid-out

Simply push the sleeve forward to change the bit. The spring mechanism lifts the bit off the magnet and unlocks the tool. The bit can be easily removed. The rapid-out function makes it easy to remove even the smallest bits without extra tools.

Rapid-spin

The free-spinning outer sleeve stabilises battery or mains-powered tools during the screwdriving process. This makes it easier to apply the tool to the screw and prevents slipping.

Chuck-all

The Rapidaptor quick-release chucks hold ¼" DIN ISO 1173 C 6,3 and E 6,3 as well as Wera series 1 and 4 bits.

Single-hand function

Every function of the Rapidaptor quick-release chuck, such as inserting or releasing bits, can be carried out with one hand. This is faster, more economical and more ergonomic. There are no unnecessary manoeuvres.

Rapidaptor with ring magnet

The floating, free-spinning magnetic sleeve holds even large and heavy screws very securely for fast application, eliminating the need to hold the screw, which can be dangerous and painful. Perfect for overhead work.

SPKL L-keys

L-keys with a rubber sleeve (SPKL) are made from easy-to-grip round bars. The sleeve ensures comfortable and safe working even at low temperatures. High corrosion protection.

Stainless Steel Tools

Wera Stainless tools are made from 100 % stainless steel. Their wear debris consists of rustproof stainless steel particles, which prevents unsightly extraneous rust. Wera stainless steel tools are vacuum ice-hardened to give them the necessary hardness and rigidity for industrial applications.

Take it easy Tool Finder

"Take it easy" tool finder with colour coding according to sizes – for simple and rapid accessing of the required tool.

Titanium nitride coated bits

Industrial applications are subject to permanent stresses that place high demands on the durability of the tool. Bits for these applications are coated with extremely hard titanium nitride. This abrasion-proof coating provides the necessary hardness that is required on a mass production line.

TORQ-SET® Mplus

Wera developed the Mplus profile with stronger flanks compared with tools with a conventional TORQ-SET® profile. This results in approximately 70 % extra torsional strength and greatly extends the service life of Wera Mplus tools.

TORQUE-indicators

Wera TORQUE-indicators have been factory pre-set to TORQUE values recommended by leading carbide tool manufacturers. Tightening values are precisely related to the size of the TORX®, TORX PLUS® or hexagon socket screw. TORQUE-indicators ensure safe and easily loosened screw connections.

TORQUE Screwdrivers

Adjustable TORQUE screwdrivers:

TORQUE can be set to the required scale value by hand without special tools.

Pre-set adjustable TORQUE screwdrivers:

With pre-set TORQUE, adjustable within a defined range.

Torsion bits

By diverting TORQUE peaks into the Torsion zone of the bit, premature wear and tear is avoided and dramatically improved service life is achieved.

TORX® B0 with borehole

TORX® tools with a borehole prevent the unauthorised unfastening of safety screws. The screws contain a pin that protrudes into the drive profile so that "normal" TORX® tools cannot be used. This pin fits into the borehole of TORX® B0 tools allowing safety screws to be unfastened.

TORX® with holding function (HF)

The optimised profile wedges the screw to the tool. This is very important in situations where a magnetic screw holder cannot or must not be used (for instance, jobs involving power tools where metal filings attracted by a magnet could affect the screwdriving process, or jobs requiring wedging forces and stainless steel tools, which are non-magnetic because of the nature of the material). The wedging effect can be guaranteed only for tools made to Acument Global Technologies Inc. specifications.

TORX® with pin

The protruding pin that fits into the borehole of the screw makes it easier to centre the tool in the screw recess.

TORX® Wedge

The conical TORX® profile provides a better fit in the screw. Combined with a great recess depth this produces a pinch effect.

TORX PLUS®

Compared with the "normal", round TORX® profile the elliptical profile of TORX PLUS® tools makes it possible to increase the size of the 6 flanks that transfer TORQUE between the tool and the screw. The force applied by the user is distributed across a larger surface area allowing more TORQUE to be transferred and extending the service life of both the screw and the tool.

TORX PLUS® IPR

A 5-flank TORX PLUS® profile with a borehole. This drive geometry has only five flanks instead of the usual six and a borehole to protect safety screws against unauthorised unfastening. The screws cannot be turned with conventional, widely available tools.

Tough absorbing bits (Z)

Tough absorbing bits for hard materials, e.g. sheet steel or metal. Here the screw initially turns smoothly inside the defined thread. As soon as the head of the screw touches the surface of the material large amounts of peak TORQUE are generated that affects both the screw and the tool. Bits that are too hard are likely to break under these conditions.

Two-component clip for L-keys

The durable clip material ensures that L-keys are securely fixed and easy to remove. Abrasion resistant markings help you find the right size tool straight away.

Wrenches, Joker

The Joker's holding function means that nuts and bolts can be held in the jaw and easily positioned where they are needed. Fastening on to the thread can then be done quickly and safely, thanks to the innovative special stop-plate which holds the fastener. No more time-wasting searches for dropped nuts and bolts!

Zyklop ratchets

- Zyklop Speed – A really fast mover.
- Zyklop Hybrid – Combines robustness, slim design, and little weight.
- Zyklop Metal – Extremely slim. Long leverage.
- Zyklop Mini – Rapid fastening even in confined working situations.
- Zyklop ratchet VDE – Insulated and 100% individually tested Zyklop VDE ratchet for safe working up to 1,000 volts.

Zyklop Mini 1

The strong ¼" Bit Ratchet that can withstand at least 65 Nm. Suitable for bits directly driven and sockets (using adaptor). Fine tooth mechanism with 60 teeth, simple switching between left/right operations. Ideal for very confined spaces, where conventional screwdrivers are just too big. Drop-forged full steel design.

Zyklop Mini 2

The Zyklop Mini 2 is suitable for the direct attachment of the special Wera Zyklop sockets 8790 FA. These sockets feature a very low height, ideal for confined working spaces.

TORQUE Test Values



Slotted Tools

Drives: DIN ISO 2380, VSM 35601.
TORQUE values evaluated in test gages according to DIN ISO 2380 on TORQUE testing equipment.

| a x b mm | TORQUE in Nm (min) | |
|-------------|-----------------------|----------|
| | handuse | poweruse |
| 0,3 x 2,0 | 0,18 | 0,20 |
| 0,4 x 2,0 | 0,30 | 0,35 |
| 0,4 x 2,5 | 0,40 | 0,45 |
| 0,5 x 3,0 | 0,70 | 0,80 |
| 0,5 x 3,5 | 0,90 | 0,98 |
| 0,6 x 3,5 | 1,30 | 1,40 |
| 0,6 x 4,0 | 1,40 | 1,61 |
| 0,6 x 4,5 | - | 1,80 |
| 0,8 x 4,0 | 2,60 | 2,90 |
| 0,8 x 4,5 | 2,88 | |
| 0,8 x 5,0 | 3,20 | 3,58 |
| 0,8 x 5,5 | 3,50 | 3,90 |
| 1,0 x 5,5 | 5,50 | 6,20 |
| 1,0 x 6,5 | 6,50 | 7,28 |
| 1,0 x 7,0 | 7,0 | 7,80 |
| 1,2 x 6,5 | 9,40 | 10,50 |
| 1,2 x 7,0 | 10,0 | 11,28 |
| 1,2 x 8,0 | 11,5 | 12,90 |
| 1,4 x 9,0 | 17,6 | 19,70 |
| 1,5 x 13 | 29 | 32 |
| 1,6 x 8,0 | 20,5 | 22,9 |
| 1,6 x 9,0 | 23 | 25 |
| 1,6 x 10 | 25,6 | 28,7 |
| 2,0 x 12 | 48,0 | 53 |
| 2,0 x 13 | 52 | 58 |
| 2,5 x 14 | 87 | 98 |
| 2,5 x 16 | 100 | 112 |
| 3,0 x 18 | 162 | 181 |

Important device:

After TORQUE testing with the minimum value, screwdrivers shall not show any deformation or injuries at the tip.



Hexagon Tools

Drives: DIN ISO 2936. TORQUE values evaluated in test gages according to DIN ISO 2936 on TORQUE testing equipment.

| SW (mm) | TORQUE in Nm (min) |
|------------|-----------------------|
| 0,7 | 0,08 |
| 0,9 | 0,18 |
| 1,3 | 0,53 |
| 1,5 | 0,82 |
| 2,0 | 1,9 |
| 2,5 | 3,8 |
| 3 | 6,6 |
| 3,5 | 11 |
| 4 | 16 |
| 4,5 | 24 |
| 5 | 30 |
| 6 | 52 |
| 7 | 78 |
| 8 | 120 |
| 9 | 180 |
| 10 | 220 |
| 11 | 295 |
| 12 | 370 |
| 13 | 480 |
| 14 | 590 |
| 17 | 1000 |
| 19 | 1000 |
| 22 | 1000 |
| 24 | 1000 |
| 27 | 1000 |



PH and PZ Tools

Drives: DIN 5260, ISO 8764 and SMS-SS 1687.
TORQUE values evaluated in test gages according to DIN 5261, ISO 8764 on TORQUE testing equipment.

| | TORQUE in Nm (min) | |
|---|-----------------------|----------|
| | handuse | poweruse |
| 0 | 1,0 | 1,0 |
| 1 | 3,5 | 3,9 |
| 2 | 8,2 | 10,3 |
| 3 | 19,5 | 32,0 |
| 4 | 38,0 | 88,7 |



Tools with TORX® and TORX PLUS® drive

TORQUE values evaluated with testing gages of Acument Global Technologies Inc., licensor of TORX® and TORX PLUS®.

| | TORQUE in Nm (min.) | | | | | |
|----|---------------------|-----------|--------------|------------|-----------|--------------|
| | TORX® | | | TORX PLUS® | | |
| | Bit | Resis-Bit | Screw-driver | Bit | Resis-Bit | Screw-driver |
| 1 | 0,10 | - | 0,08 | 0,11 | | |
| 2 | 0,14 | - | 0,12 | 0,16 | | |
| 3 | 0,25 | - | 0,21 | 0,28 | | |
| 4 | 0,37 | - | 0,31 | 0,44 | | |
| 5 | 0,51 | - | 0,43 | 0,61 | | |
| 6 | 0,91 | - | 0,75 | 1,11 | | 0,92 |
| 7 | 1,7 | 1,4 | 1,4 | 2,10 | | 1,68 |
| 8 | 2,6 | 2,2 | 2,2 | 3,21 | 2,5 | 2,79 |
| 9 | 3,4 | 2,9 | 2,8 | 4,19 | 3,3 | 3,49 |
| 10 | 4,5 | 3,8 | 3,7 | 5,42 | 4,3 | 4,47 |
| 15 | 7,7 | 6,5 | 6,4 | 9,62 | 7,3 | 8,06 |
| 20 | 12,7 | 10,8 | 10,5 | 16,15 | 11,9 | 13,41 |
| 25 | 19,0 | 16,1 | 15,9 | 23,50 | 17,4 | 19,58 |
| 27 | 26,9 | 22,9 | 22,5 | 34,62 | 25,1 | 28,95 |
| 30 | 37,4 | 31,8 | 31,1 | 47,18 | 33,5 | 39,34 |
| 40 | 65,1 | 55,3 | 54,1 | 82,08 | 59,4 | 68,40 |
| 45 | 104 | 88 | 86 | 137,38 | 97,3 | 114,44 |
| 50 | 159 | 135 | 132 | 194,54 | 152,4 | 162,14 |
| 55 | 257 | 218 | 218 | 352,10 | 291,5 | 299,25 |
| 60 | 445 | 379 | 379 | 566,11 | 483,0 | 481,24 |
| 70 | 701 | 596 | 600 | 910,40 | 713,3 | 773,91 |



Tools with TORQ-SET® drive

TORQUE values evaluated with testing gages of Phillips Screw Company, licensor of TORQ-SET®, on TORQUE testing equipment.

| | TORQUE in Nm (min) | |
|-------|-----------------------|---------------|
| | Bits | Screw-drivers |
| 2 | 1,1 | 1,1 |
| 3 | 1,7 | 1,7 |
| 4 | 2,8 | 2,8 |
| 5 | 4,0 | 4,0 |
| 6 | 5,1 | 5,1 |
| 8 | 8,5 | 8,5 |
| 10 | 11,3 | 11,3 |
| 1/4" | 28 | 17 |
| 5/16" | 56 | 28 |
| 3/8" | 102 | 62 |
| 7/16" | 147 | |
| 1/2" | 249 | |
| 9/16" | 271 | |
| 5/8" | 339 | |

Dimensions Of Profiles

TORX® Recess Screws

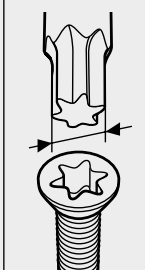

| | A Ref. (mm) |
|-------|-------------|
| TX 1 | 0,84 |
| TX 2 | 0,94 |
| TX 3 | 1,12 |
| TX 4 | 1,30 |
| TX 5 | 1,37 |
| TX 6 | 1,65 |
| TX 7 | 1,97 |
| TX 8 | 2,30 |
| TX 9 | 2,48 |
| TX 10 | 2,72 |
| TX 15 | 3,26 |
| TX 20 | 3,84 |
| TX 25 | 4,40 |
| TX 27 | 4,96 |
| TX 30 | 5,49 |
| TX 40 | 6,60 |
| TX 45 | 7,77 |
| TX 50 | 8,79 |
| TX 55 | 11,17 |
| TX 60 | 13,20 |
| TX 70 | 15,49 |

TORX PLUS® Recess Screws

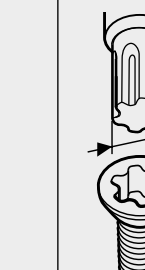

| | A Ref. (mm) |
|-------|-------------|
| 1 IP | 0,84 |
| 2 IP | 0,95 |
| 3 IP | 1,13 |
| 4 IP | 1,29 |
| 5 IP | 1,41 |
| 6 IP | 1,69 |
| 7 IP | 1,97 |
| 8 IP | 2,29 |
| 9 IP | 2,48 |
| 10 IP | 2,72 |
| 15 IP | 3,25 |
| 20 IP | 3,84 |
| 25 IP | 4,39 |
| 27 IP | 4,95 |
| 30 IP | 5,49 |
| 40 IP | 6,60 |
| 45 IP | 7,77 |
| 50 IP | 8,79 |
| 55 IP | 11,16 |
| 60 IP | 13,20 |
| 70 IP | 15,48 |

TORQ-SET® Recess Screws

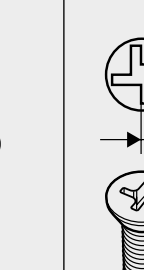

| | A Ref. (mm) |
|-------|-------------|
| 0 | 0,43 |
| 1 | 0,43 |
| 2 | 0,43 |
| 3 | 0,48 |
| 4 | 0,56 |
| 5 | 0,63 |
| 6 | 0,71 |
| 8 | 0,84 |
| 10 | 0,96 |
| 1/4" | 1,27 |
| 5/16" | 1,60 |
| 3/8" | 1,90 |
| 7/16" | 2,23 |
| 1/2" | 2,54 |

TRI-WING® Recess Screws

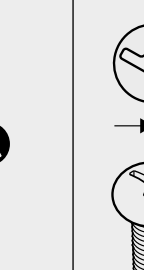

| | A Ref. (mm) |
|----|-------------|
| 0 | 0,45 |
| 1 | 0,57 |
| 2 | 0,75 |
| 3 | 0,95 |
| 4 | 1,08 |
| 5 | 1,23 |
| 6 | 1,54 |
| 7 | 1,87 |
| 8 | 2,17 |
| 9 | 2,48 |
| 10 | 2,78 |

XZN Recess Screws

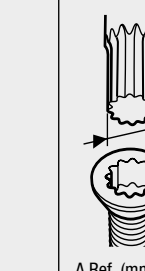

| | A Ref. (mm) |
|------|-------------|
| M 4 | 3,83 |
| M 5 | 4,80 |
| M 6 | 6,00 |
| M 8 | 7,20 |
| M 10 | 9,60 |
| M 12 | 11,41 |
| M 14 | 13,22 |
| M 16 | 15,63 |
| M 18 | 16,85 |
| M 20 | 19,25 |

Square Recess Screws

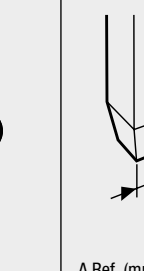

| | A Ref. (mm) | A Ref. (mm) |
|----|-------------|-------------|
| 00 | 1,27 | 1,4 |
| 0 | 1,78 | 2 |
| 1 | 2,31 | 2,5 |
| 2 | 2,85 | 3,1 |
| 3 | 3,37 | 3,7 |
| 4 | 4,84 | 5,1 |

Spanner Recess Screws

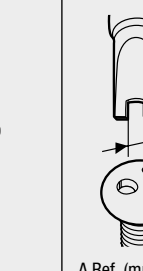

| | A Ref. (mm) |
|----|-------------|
| 4 | 1,52 |
| 6 | 2,41 |
| 8 | 2,79 |
| 10 | 3,30 |

TORQUE Conversion Table

| Conversion | | | | | | | | |
|-------------------|----------|---------|--------|--------------|--------|--------------|---------|-----------|
| Units | SI Units | | | Metric scale | | USA GB scale | | |
| | cNm | dNm | Nm | cmkg | mkg | ft.lb | in.lb | in.oz |
| 1 cNm = | 1 | 0,1 | 0,01 | 0,1020 | 0,0010 | 0,0074 | 0,0885 | 1,4161 |
| 1 dNm = | 10 | 1 | 0,1 | 1,0197 | 0,0102 | 0,0738 | 0,8851 | 14,1612 |
| 1 Nm = | 100 | 10 | 1 | 10,1972 | 0,1020 | 0,7376 | 8,8508 | 141,6123 |
| 1 cmkg = | 9,8067 | 0,9807 | 0,0981 | 1 | 0,0100 | 0,0723 | 0,8680 | 13,8874 |
| 1 mkg = | 980,6650 | 98,0665 | 9,8067 | 100 | 1 | 7,2330 | 86,7964 | 1388,7422 |
| 1 ft.lb = | 135,5818 | 13,5581 | 1,3558 | 13,8255 | 0,1383 | 1 | 12 | 192 |
| 1 in.lb = | 11,2985 | 1,1298 | 0,1130 | 1,1521 | 0,0115 | 0,0833 | 1 | 16 |
| 1 in. oz = | 0,7062 | 0,0706 | 0,0071 | 0,0720 | 0,0007 | 0,0052 | 0,0625 | 1 |

Example 1
 1 Nm = 0,102 mkg
 17,4 Nm = 17,4 x 0,102 mkg
 17,4 Nm = 1,775 mkg

Example 2
 1 mkg = 9,8067 Nm
 12,5 mkg = 12,5 x 9,8067 Nm
 12,5 mkg = 122,58 Nm

Conversion Nm in mkg **1 Nm = 0,10197 mkg**

| Nm | 0 | 1 | 2 | 3 | 4 | 5 | 6 | 7 | 8 | 9 |
|-----|-------|-------|-------|-------|-------|-------|-------|-------|-------|-------|
| 0 | 0,00 | 0,10 | 0,20 | 0,31 | 0,41 | 0,51 | 0,61 | 0,71 | 0,82 | 0,92 |
| 10 | 1,02 | 1,12 | 1,22 | 1,33 | 1,43 | 1,53 | 1,63 | 1,73 | 1,84 | 1,94 |
| 20 | 2,04 | 2,14 | 2,24 | 2,35 | 2,45 | 2,55 | 2,65 | 2,75 | 2,86 | 2,96 |
| 30 | 3,06 | 3,16 | 3,26 | 3,37 | 3,47 | 3,57 | 3,67 | 3,77 | 3,87 | 3,98 |
| 40 | 4,08 | 4,18 | 4,28 | 4,38 | 4,49 | 4,59 | 4,69 | 4,79 | 4,89 | 5,00 |
| 50 | 5,10 | 5,20 | 5,30 | 5,40 | 5,51 | 5,61 | 5,71 | 5,81 | 5,91 | 6,02 |
| 60 | 6,12 | 6,22 | 6,32 | 6,42 | 6,53 | 6,63 | 6,73 | 6,83 | 6,93 | 7,04 |
| 70 | 7,14 | 7,24 | 7,34 | 7,44 | 7,55 | 7,65 | 7,75 | 7,85 | 7,95 | 8,06 |
| 80 | 8,16 | 8,26 | 8,36 | 8,46 | 8,57 | 8,67 | 8,77 | 8,87 | 8,97 | 9,08 |
| 90 | 9,18 | 9,28 | 9,38 | 9,48 | 9,59 | 9,69 | 9,79 | 9,89 | 9,99 | 10,10 |
| 100 | 10,20 | 10,30 | 10,40 | 10,50 | 10,60 | 10,71 | 10,81 | 10,91 | 11,01 | 11,11 |

Conversion mkg in Nm **1 mkg = 9,80665 Nm**

| mkg | 0 | 1 | 2 | 3 | 4 | 5 | 6 | 7 | 8 | 9 |
|-----|--------|--------|---------|---------|---------|---------|---------|---------|---------|---------|
| 0 | 0,00 | 9,81 | 19,61 | 29,42 | 39,23 | 49,03 | 58,84 | 68,65 | 78,45 | 88,26 |
| 10 | 98,07 | 107,87 | 117,68 | 127,49 | 137,29 | 147,10 | 156,91 | 166,71 | 176,52 | 186,33 |
| 20 | 196,13 | 205,94 | 215,75 | 225,55 | 235,36 | 245,17 | 254,97 | 264,78 | 274,59 | 284,39 |
| 30 | 294,20 | 304,01 | 313,81 | 323,62 | 333,43 | 343,23 | 353,04 | 362,85 | 372,65 | 382,46 |
| 40 | 392,27 | 402,07 | 411,88 | 421,69 | 431,49 | 441,30 | 451,11 | 460,91 | 470,72 | 480,53 |
| 50 | 490,33 | 500,14 | 509,95 | 519,75 | 529,56 | 539,37 | 549,17 | 558,98 | 568,79 | 578,59 |
| 60 | 588,40 | 598,21 | 608,01 | 617,82 | 627,63 | 637,43 | 647,24 | 657,05 | 666,85 | 676,66 |
| 70 | 686,47 | 696,27 | 706,08 | 715,89 | 725,69 | 735,50 | 745,31 | 755,11 | 764,92 | 774,73 |
| 80 | 784,53 | 794,34 | 804,15 | 813,95 | 823,76 | 833,57 | 843,37 | 853,18 | 862,99 | 872,79 |
| 90 | 882,60 | 892,41 | 902,21 | 912,02 | 921,83 | 931,63 | 941,44 | 951,25 | 961,05 | 970,86 |
| 100 | 980,67 | 990,47 | 1000,28 | 1010,08 | 1019,89 | 1029,70 | 1039,50 | 1049,31 | 1059,12 | 1068,92 |

Conversion Nm in ft.lb **1 Nm = 0,73756 ft.lb**

| Nm | 0 | 1 | 2 | 3 | 4 | 5 | 6 | 7 | 8 | 9 |
|-----|-------|-------|-------|-------|-------|-------|-------|-------|-------|-------|
| 0 | 0,00 | 0,74 | 1,48 | 2,21 | 2,95 | 3,69 | 4,43 | 5,16 | 5,90 | 6,64 |
| 10 | 7,38 | 8,11 | 8,85 | 9,59 | 10,33 | 11,06 | 11,80 | 12,54 | 13,28 | 14,01 |
| 20 | 14,75 | 15,49 | 16,23 | 16,96 | 17,70 | 18,44 | 19,18 | 19,91 | 20,65 | 21,39 |
| 30 | 22,13 | 22,86 | 23,60 | 24,34 | 25,08 | 25,81 | 26,55 | 27,29 | 28,03 | 28,76 |
| 40 | 29,50 | 30,24 | 30,98 | 31,72 | 32,45 | 33,19 | 33,93 | 34,67 | 35,40 | 36,14 |
| 50 | 36,88 | 37,62 | 38,35 | 39,09 | 39,83 | 40,57 | 41,30 | 42,04 | 42,78 | 43,52 |
| 60 | 44,25 | 44,99 | 45,73 | 46,47 | 47,20 | 47,94 | 48,68 | 49,42 | 50,15 | 50,89 |
| 70 | 51,63 | 52,37 | 53,10 | 53,84 | 54,58 | 55,32 | 56,05 | 56,79 | 57,53 | 58,27 |
| 80 | 59,00 | 59,74 | 60,48 | 61,22 | 61,96 | 62,69 | 63,43 | 64,17 | 64,91 | 65,64 |
| 90 | 66,38 | 67,12 | 67,86 | 68,59 | 69,33 | 70,07 | 70,81 | 71,54 | 72,28 | 73,02 |
| 100 | 73,76 | 74,49 | 75,23 | 75,97 | 76,71 | 77,44 | 78,18 | 78,92 | 79,66 | 80,39 |

Conversion ft.lb in Nm **1 ft.lb = 1,35581 Nm**

| ft.lb | 0 | 1 | 2 | 3 | 4 | 5 | 6 | 7 | 8 | 9 |
|-------|--------|--------|--------|--------|--------|--------|--------|--------|--------|--------|
| 0 | 0,00 | 1,36 | 2,71 | 4,07 | 5,42 | 6,78 | 8,13 | 9,49 | 10,85 | 12,20 |
| 10 | 13,56 | 14,91 | 16,27 | 17,63 | 18,98 | 20,34 | 21,69 | 23,05 | 24,40 | 25,76 |
| 20 | 27,12 | 28,47 | 29,83 | 31,18 | 32,54 | 33,90 | 35,25 | 36,61 | 37,96 | 39,32 |
| 30 | 40,67 | 42,03 | 43,39 | 44,74 | 46,10 | 47,45 | 48,81 | 50,16 | 51,52 | 52,88 |
| 40 | 54,23 | 55,59 | 56,94 | 58,30 | 59,66 | 61,01 | 62,37 | 63,72 | 65,08 | 66,43 |
| 50 | 67,79 | 69,15 | 70,50 | 71,86 | 73,21 | 74,57 | 75,93 | 77,28 | 78,64 | 79,99 |
| 60 | 81,35 | 82,70 | 84,06 | 85,42 | 86,77 | 88,13 | 89,48 | 90,84 | 92,20 | 93,55 |
| 70 | 94,91 | 96,26 | 97,62 | 98,97 | 100,33 | 101,69 | 103,04 | 104,40 | 105,75 | 107,11 |
| 80 | 108,46 | 109,82 | 111,18 | 112,53 | 113,89 | 115,24 | 116,60 | 117,96 | 119,31 | 120,67 |
| 90 | 122,02 | 123,38 | 124,73 | 126,09 | 127,45 | 128,80 | 130,16 | 131,51 | 132,87 | 134,23 |
| 100 | 135,58 | 136,94 | 138,29 | 139,65 | 141,00 | 142,36 | 143,72 | 145,07 | 146,43 | 147,78 |

Conversion Nm in in.lb **1 Nm = 8,85077 in.lb**

| Nm | 0 | 1 | 2 | 3 | 4 | 5 | 6 | 7 | 8 | 9 |
|-----|--------|--------|--------|--------|--------|--------|--------|--------|--------|--------|
| 0 | 0,00 | 8,85 | 17,70 | 26,55 | 35,40 | 44,25 | 53,10 | 61,96 | 70,81 | 79,66 |
| 10 | 88,51 | 97,36 | 106,21 | 115,06 | 123,91 | 132,76 | 141,61 | 150,46 | 159,31 | 168,16 |
| 20 | 177,02 | 185,87 | 194,72 | 203,57 | 212,42 | 221,27 | 230,12 | 238,97 | 247,82 | 256,67 |
| 30 | 265,52 | 274,37 | 283,22 | 292,08 | 300,93 | 309,78 | 318,63 | 327,48 | 336,33 | 345,18 |
| 40 | 354,03 | 362,88 | 371,73 | 380,58 | 389,43 | 398,28 | 407,14 | 415,99 | 424,84 | 433,69 |
| 50 | 442,54 | 451,39 | 460,24 | 469,09 | 477,94 | 486,79 | 495,64 | 504,49 | 513,34 | 522,20 |
| 60 | 531,05 | 539,90 | 548,75 | 557,60 | 566,45 | 575,30 | 584,15 | 593,00 | 601,85 | 610,70 |
| 70 | 619,55 | 628,40 | 637,26 | 646,11 | 654,96 | 663,81 | 672,66 | 681,51 | 690,36 | 699,21 |
| 80 | 708,06 | 716,91 | 725,76 | 734,61 | 743,46 | 752,32 | 761,17 | 770,02 | 778,87 | 787,72 |
| 90 | 796,57 | 805,42 | 814,27 | 823,12 | 831,97 | 840,82 | 849,67 | 858,52 | 867,38 | 876,23 |
| 100 | 885,08 | 893,93 | 902,78 | 911,63 | 920,48 | 929,33 | 938,18 | 947,03 | 955,88 | 964,73 |

Conversion in.lb in Nm **1 in.lb = 0,11298 Nm**

| in.lb | 0 | 1 | 2 | 3 | 4 | 5 | 6 | 7 | 8 | 9 |
|-------|-------|-------|-------|-------|-------|-------|-------|-------|-------|-------|
| 0 | 0,00 | 0,11 | 0,23 | 0,34 | 0,45 | 0,56 | 0,68 | 0,79 | 0,90 | 1,02 |
| 10 | 1,13 | 1,24 | 1,36 | 1,47 | 1,58 | 1,69 | 1,81 | 1,92 | 2,03 | 2,15 |
| 20 | 2,26 | 2,37 | 2,49 | 2,60 | 2,71 | 2,82 | 2,94 | 3,05 | 3,16 | 3,28 |
| 30 | 3,39 | 3,50 | 3,62 | 3,73 | 3,84 | 3,95 | 4,07 | 4,18 | 4,29 | 4,41 |
| 40 | 4,52 | 4,63 | 4,75 | 4,86 | 4,97 | 5,08 | 5,20 | 5,31 | 5,42 | 5,54 |
| 50 | 5,65 | 5,76 | 5,87 | 5,99 | 6,10 | 6,21 | 6,33 | 6,44 | 6,55 | 6,67 |
| 60 | 6,78 | 6,89 | 7,00 | 7,12 | 7,23 | 7,34 | 7,46 | 7,57 | 7,68 | 7,80 |
| 70 | 7,91 | 8,02 | 8,13 | 8,25 | 8,36 | 8,47 | 8,59 | 8,70 | 8,81 | 8,93 |
| 80 | 9,04 | 9,15 | 9,26 | 9,38 | 9,49 | 9,60 | 9,72 | 9,83 | 9,94 | 10,06 |
| 90 | 10,17 | 10,28 | 10,39 | 10,51 | 10,62 | 10,73 | 10,85 | 10,96 | 11,07 | 11,19 |
| 100 | 11,30 | 11,41 | 11,52 | 11,64 | 11,75 | 11,86 | 11,98 | 12,09 | 12,20 | 12,31 |

Conversion Of Inches To Millimeters

| Inches | | 0 | 1 | 2 | 3 | 4 | 5 | 6 | 7 | 8 | 9 |
|--------|----------|--------|--------|--------|---------|---------|---------|---------|---------|---------|---------|
| | | | 25.400 | 50.800 | 76.200 | 101.600 | 127.000 | 152.400 | 177.800 | 203.200 | 228.600 |
| 1/64 | 0.015625 | 0.397 | 25.797 | 51.197 | 76.597 | 101.997 | 127.397 | 152.797 | 178.197 | 203.597 | 228.997 |
| 1/32 | 0.03125 | 0.794 | 26.194 | 51.594 | 76.994 | 102.394 | 127.794 | 153.194 | 178.594 | 203.994 | 229.394 |
| 3/64 | 0.046875 | 1.191 | 26.591 | 51.991 | 77.391 | 102.791 | 128.191 | 153.591 | 178.991 | 204.391 | 229.791 |
| 1/16 | 0.0625 | 1.588 | 26.988 | 52.388 | 77.788 | 103.188 | 128.588 | 153.988 | 179.388 | 204.788 | 230.188 |
| 5/64 | 0.078125 | 1.984 | 27.384 | 52.784 | 78.184 | 103.584 | 128.984 | 154.384 | 179.784 | 205.184 | 230.584 |
| 3/32 | 0.09375 | 2.381 | 27.781 | 53.181 | 78.581 | 103.981 | 129.381 | 154.781 | 180.181 | 205.581 | 230.981 |
| 7/64 | 0.109375 | 2.778 | 28.178 | 53.578 | 78.978 | 104.378 | 129.778 | 155.178 | 180.578 | 205.978 | 231.378 |
| 1/8 | 0.125 | 3.175 | 28.575 | 53.975 | 79.375 | 104.775 | 130.175 | 155.575 | 180.975 | 206.375 | 231.775 |
| 9/64 | 0.140625 | 3.572 | 28.972 | 54.372 | 79.772 | 105.172 | 130.572 | 155.972 | 181.372 | 206.772 | 232.172 |
| 5/32 | 0.15625 | 3.969 | 29.369 | 54.769 | 80.169 | 105.569 | 130.969 | 156.369 | 181.769 | 207.169 | 232.569 |
| 11/64 | 0.171875 | 4.366 | 29.766 | 55.166 | 80.566 | 105.966 | 131.366 | 156.766 | 182.166 | 207.566 | 232.966 |
| 3/16 | 0.1875 | 4.762 | 30.162 | 55.562 | 80.962 | 106.362 | 131.762 | 157.162 | 182.562 | 207.962 | 233.362 |
| 13/64 | 0.203125 | 5.159 | 30.559 | 55.959 | 81.359 | 106.759 | 132.159 | 157.559 | 182.959 | 208.359 | 233.759 |
| 7/32 | 0.21875 | 5.556 | 30.956 | 56.356 | 81.756 | 107.156 | 132.556 | 157.956 | 183.356 | 208.756 | 234.156 |
| 15/64 | 0.234375 | 5.953 | 31.353 | 56.753 | 82.153 | 107.553 | 132.953 | 158.353 | 183.753 | 209.153 | 234.553 |
| 1/4 | 0.25 | 6.350 | 31.750 | 57.150 | 82.550 | 107.950 | 133.350 | 158.750 | 184.150 | 209.550 | 234.950 |
| 17/64 | 0.265625 | 6.747 | 32.147 | 57.547 | 82.947 | 108.347 | 133.747 | 159.147 | 184.547 | 209.947 | 235.347 |
| 9/32 | 0.28125 | 7.144 | 32.544 | 57.944 | 83.344 | 108.744 | 134.144 | 159.544 | 184.944 | 210.344 | 235.744 |
| 19/64 | 0.296875 | 7.541 | 32.941 | 58.341 | 83.741 | 109.141 | 134.541 | 159.941 | 185.341 | 210.741 | 236.141 |
| 5/16 | 0.3125 | 7.938 | 33.338 | 58.738 | 84.138 | 109.538 | 134.938 | 160.338 | 185.738 | 211.138 | 236.538 |
| 21/64 | 0.328125 | 8.334 | 33.734 | 59.134 | 84.534 | 109.934 | 135.334 | 160.734 | 186.134 | 211.534 | 236.934 |
| 11/32 | 0.34375 | 8.731 | 34.131 | 59.531 | 84.931 | 110.331 | 135.731 | 161.131 | 186.531 | 211.931 | 237.331 |
| 23/64 | 0.359375 | 9.128 | 34.528 | 59.928 | 85.328 | 110.728 | 136.128 | 161.528 | 186.928 | 212.328 | 237.728 |
| 3/8 | 0.375 | 9.525 | 34.925 | 60.325 | 85.725 | 111.125 | 136.525 | 161.925 | 187.325 | 212.725 | 238.125 |
| 25/64 | 0.390625 | 9.922 | 35.322 | 60.722 | 86.122 | 111.522 | 136.922 | 162.322 | 187.722 | 213.122 | 238.522 |
| 13/32 | 0.40625 | 10.319 | 35.719 | 61.119 | 86.519 | 111.919 | 137.319 | 162.719 | 188.119 | 213.519 | 238.919 |
| 27/64 | 0.421875 | 10.716 | 36.116 | 61.516 | 86.916 | 112.316 | 137.716 | 163.116 | 188.516 | 213.916 | 239.316 |
| 7/16 | 0.4375 | 11.112 | 36.512 | 61.912 | 87.312 | 112.712 | 138.112 | 163.512 | 188.912 | 214.312 | 239.712 |
| 29/64 | 0.453125 | 11.509 | 36.909 | 62.309 | 87.709 | 113.109 | 138.509 | 163.909 | 189.309 | 214.709 | 240.109 |
| 15/32 | 0.46875 | 11.906 | 37.306 | 62.706 | 88.106 | 113.506 | 138.906 | 164.306 | 189.706 | 215.106 | 240.506 |
| 31/64 | 0.484375 | 12.303 | 37.703 | 63.103 | 88.503 | 113.903 | 139.303 | 164.703 | 190.103 | 215.503 | 240.903 |
| 1/2 | 0.5 | 12.700 | 38.100 | 63.500 | 88.900 | 114.300 | 139.700 | 165.100 | 190.500 | 215.900 | 241.300 |
| 33/64 | 0.515625 | 13.097 | 38.497 | 63.897 | 89.297 | 114.697 | 140.097 | 165.497 | 190.897 | 216.297 | 241.697 |
| 17/32 | 0.53125 | 13.494 | 38.894 | 64.294 | 89.694 | 115.094 | 140.494 | 165.894 | 191.294 | 216.694 | 242.094 |
| 35/64 | 0.546875 | 13.891 | 39.291 | 64.691 | 90.091 | 115.491 | 140.891 | 166.291 | 191.691 | 217.091 | 242.491 |
| 9/16 | 0.5625 | 14.288 | 39.688 | 65.088 | 90.488 | 115.888 | 141.288 | 166.688 | 192.088 | 217.488 | 242.888 |
| 37/64 | 0.578125 | 14.684 | 40.084 | 65.484 | 90.884 | 116.284 | 141.684 | 167.084 | 192.484 | 217.884 | 243.284 |
| 19/32 | 0.59375 | 15.081 | 40.481 | 65.881 | 91.281 | 116.681 | 142.081 | 167.481 | 192.881 | 218.281 | 243.681 |
| 39/64 | 0.609375 | 15.478 | 40.878 | 66.278 | 91.678 | 117.078 | 142.478 | 167.878 | 193.278 | 218.678 | 244.078 |
| 5/8 | 0.625 | 15.875 | 41.275 | 66.675 | 92.075 | 117.475 | 142.875 | 168.275 | 193.675 | 219.075 | 244.475 |
| 41/64 | 0.640625 | 16.272 | 41.672 | 67.072 | 92.472 | 117.872 | 143.272 | 168.672 | 194.072 | 219.472 | 244.872 |
| 21/32 | 0.65625 | 16.669 | 42.069 | 67.469 | 92.869 | 118.269 | 143.669 | 169.069 | 194.469 | 219.869 | 245.269 |
| 43/64 | 0.671875 | 17.066 | 42.466 | 67.866 | 93.266 | 118.666 | 144.066 | 169.466 | 194.866 | 220.266 | 245.666 |
| 11/16 | 0.6875 | 17.462 | 42.862 | 68.262 | 93.662 | 119.062 | 144.462 | 169.862 | 195.262 | 220.662 | 246.062 |
| 45/64 | 0.703125 | 17.859 | 43.259 | 68.659 | 94.059 | 119.459 | 144.859 | 170.259 | 195.659 | 221.059 | 246.459 |
| 23/32 | 0.71875 | 18.256 | 43.656 | 69.056 | 94.456 | 119.856 | 145.256 | 170.656 | 196.056 | 221.456 | 246.856 |
| 47/64 | 0.734375 | 18.653 | 44.053 | 69.453 | 94.853 | 120.253 | 145.653 | 171.053 | 196.453 | 221.853 | 247.253 |
| 3/4 | 0.75 | 19.050 | 44.450 | 69.850 | 95.250 | 120.650 | 146.050 | 171.450 | 196.850 | 222.250 | 247.650 |
| 49/64 | 0.765625 | 19.447 | 44.847 | 70.247 | 95.647 | 121.047 | 146.447 | 171.847 | 197.247 | 222.647 | 248.047 |
| 25/32 | 0.78125 | 19.844 | 45.244 | 70.644 | 96.044 | 121.444 | 146.844 | 172.244 | 197.644 | 223.044 | 248.444 |
| 51/64 | 0.796875 | 20.241 | 45.641 | 71.041 | 96.441 | 121.841 | 147.241 | 172.641 | 198.041 | 223.441 | 248.841 |
| 13/16 | 0.8125 | 20.638 | 46.038 | 71.438 | 96.838 | 122.238 | 147.638 | 173.038 | 198.438 | 223.838 | 249.238 |
| 53/64 | 0.828125 | 21.034 | 46.434 | 71.834 | 97.234 | 122.634 | 148.034 | 173.434 | 198.834 | 224.234 | 249.634 |
| 27/32 | 0.84375 | 21.431 | 46.831 | 72.231 | 97.631 | 123.031 | 148.431 | 173.831 | 199.231 | 224.631 | 250.031 |
| 55/64 | 0.859375 | 21.828 | 47.228 | 72.628 | 98.028 | 123.428 | 148.828 | 174.228 | 199.628 | 225.028 | 250.428 |
| 7/8 | 0.875 | 22.225 | 47.625 | 73.025 | 98.425 | 123.825 | 149.225 | 174.625 | 200.025 | 225.425 | 250.825 |
| 57/64 | 0.890625 | 22.622 | 48.022 | 73.422 | 98.822 | 124.222 | 149.622 | 175.022 | 200.422 | 225.822 | 251.222 |
| 29/32 | 0.90625 | 23.019 | 48.419 | 73.819 | 99.219 | 124.619 | 150.019 | 175.419 | 200.819 | 226.219 | 251.619 |
| 59/64 | 0.921875 | 23.416 | 48.816 | 74.216 | 99.616 | 125.016 | 150.416 | 175.816 | 201.216 | 226.616 | 252.016 |
| 15/16 | 0.9375 | 23.812 | 49.212 | 74.612 | 100.012 | 125.412 | 150.812 | 176.212 | 201.612 | 227.012 | 252.412 |
| 61/64 | 0.953125 | 24.209 | 49.609 | 75.009 | 100.409 | 125.809 | 151.209 | 176.609 | 202.009 | 227.409 | 252.809 |
| 31/32 | 0.96875 | 24.606 | 50.006 | 75.406 | 100.806 | 126.206 | 151.606 | 177.006 | 202.406 | 227.806 | 253.206 |
| 63/64 | 0.984375 | 25.003 | 50.403 | 75.803 | 101.203 | 126.603 | 152.003 | 177.403 | 202.803 | 228.203 | 253.603 |

Values in mm

| Code No. | Page | Code No. | Page | Code No. | Page | Code No. | Page |
|---------------|------|---------------|------|---------------|------|---------------|------|
| 05 003521 001 | 156 | 05 003608 001 | 202 | 05 003726 001 | 156 | 05 003852 001 | 204 |
| 05 003522 001 | 156 | 05 003609 001 | 202 | 05 003727 001 | 156 | 05 003853 001 | 204 |
| 05 003523 001 | 156 | 05 003610 001 | 202 | 05 003728 001 | 156 | 05 003854 001 | 204 |
| 05 003524 001 | 166 | 05 003611 001 | 202 | 05 003729 001 | 156 | 05 003855 001 | 204 |
| 05 003525 001 | 167 | 05 003612 001 | 202 | 05 003730 001 | 202 | 05 003856 001 | 204 |
| 05 003526 001 | 166 | 05 003613 001 | 202 | 05 003731 001 | 202 | 05 003857 001 | 204 |
| 05 003527 001 | 169 | 05 003614 001 | 202 | 05 003732 001 | 202 | 05 003858 001 | 204 |
| 05 003528 001 | 169 | 05 003615 001 | 202 | 05 003733 001 | 202 | 05 003880 001 | 157 |
| 05 003529 001 | 169 | 05 003616 001 | 202 | 05 003734 001 | 202 | 05 003881 001 | 162 |
| 05 003530 001 | 166 | 05 003617 001 | 202 | 05 003735 001 | 202 | 05 003882 001 | 161 |
| 05 003531 001 | 166 | 05 003618 001 | 202 | 05 003736 001 | 202 | 05 003883 001 | 159 |
| 05 003533 001 | 148 | 05 003619 001 | 202 | 05 003737 001 | 202 | 05 003884 001 | 160 |
| 05 003535 001 | 148 | 05 003620 001 | 202 | 05 003738 001 | 202 | 05 003890 001 | 163 |
| 05 003550 001 | 174 | 05 003621 001 | 202 | 05 003739 001 | 202 | 05 003891 001 | 164 |
| 05 003551 001 | 180 | 05 003622 001 | 202 | 05 003740 001 | 180 | 05 003970 001 | 181 |
| 05 003552 001 | 180 | 05 003623 001 | 202 | 05 003741 001 | 180 | 05 003971 001 | 184 |
| 05 003553 001 | 180 | 05 003624 001 | 202 | 05 003742 001 | 180 | 05 003972 001 | 182 |
| 05 003554 001 | 180 | 05 003625 001 | 202 | 05 003743 001 | 180 | 05 003973 001 | 181 |
| 05 003555 001 | 180 | 05 003626 001 | 202 | 05 003744 001 | 180 | 05 003974 001 | 184 |
| 05 003556 001 | 180 | 05 003627 001 | 202 | 05 003745 001 | 180 | 05 003980 001 | 185 |
| 05 003557 001 | 180 | 05 003628 001 | 202 | 05 003746 001 | 180 | 05 003981 001 | 185 |
| 05 003558 001 | 180 | 05 003629 001 | 202 | 05 003747 001 | 180 | 05 003990 001 | 114 |
| 05 003559 001 | 180 | 05 003630 001 | 202 | 05 003748 001 | 180 | 05 004003 001 | 153 |
| 05 003560 001 | 180 | 05 003631 001 | 202 | 05 003749 001 | 180 | 05 004004 001 | 155 |
| 05 003561 001 | 180 | 05 003632 001 | 202 | 05 003750 001 | 180 | 05 004016 001 | 144 |
| 05 003562 001 | 180 | 05 003633 001 | 202 | 05 003751 001 | 180 | 05 004017 001 | 152 |
| 05 003563 001 | 180 | 05 003634 001 | 202 | 05 003752 001 | 180 | 05 004018 001 | 154 |
| 05 003564 001 | 180 | 05 003635 001 | 202 | 05 003753 001 | 180 | 05 004019 001 | 145 |
| 05 003565 001 | 180 | 05 003636 001 | 209 | 05 003755 001 | 144 | 05 004020 001 | 152 |
| 05 003566 001 | 180 | 05 003637 001 | 208 | 05 003756 001 | 155 | 05 004021 001 | 154 |
| 05 003567 001 | 180 | 05 003638 001 | 208 | 05 003760 001 | 228 | 05 004033 001 | 177 |
| 05 003568 001 | 180 | 05 003639 001 | 209 | 05 003765 001 | 228 | 05 004034 001 | 179 |
| 05 003569 001 | 180 | 05 003640 001 | 209 | 05 003780 001 | 196 | 05 004046 001 | 172 |
| 05 003570 001 | 180 | 05 003641 001 | 209 | 05 003781 001 | 196 | 05 004047 001 | 176 |
| 05 003571 001 | 180 | 05 003642 001 | 208 | 05 003785 001 | 179 | 05 004048 001 | 178 |
| 05 003572 001 | 180 | 05 003643 001 | 208 | 05 003820 001 | 206 | 05 004049 001 | 172 |
| 05 003573 001 | 180 | 05 003645 001 | 191 | 05 003821 001 | 206 | 05 004050 001 | 176 |
| 05 003574 001 | 180 | 05 003647 001 | 192 | 05 003822 001 | 206 | 05 004051 001 | 178 |
| 05 003575 001 | 180 | 05 003660 001 | 222 | 05 003823 001 | 206 | 05 004063 001 | 199 |
| 05 003576 001 | 180 | 05 003665 001 | 223 | 05 003824 001 | 206 | 05 004064 001 | 201 |
| 05 003577 001 | 180 | 05 003666 001 | 223 | 05 003825 001 | 206 | 05 004076 001 | 190 |
| 05 003578 001 | 180 | 05 003667 001 | 223 | 05 003826 001 | 206 | 05 004077 001 | 198 |
| 05 003579 001 | 180 | 05 003668 001 | 223 | 05 003827 001 | 206 | 05 004078 001 | 200 |
| 05 003580 001 | 180 | 05 003669 001 | 223 | 05 003828 001 | 206 | 05 004079 001 | 190 |
| 05 003581 001 | 187 | 05 003670 001 | 223 | 05 003829 001 | 206 | 05 004080 001 | 198 |
| 05 003582 001 | 186 | 05 003675 001 | 223 | 05 003830 001 | 204 | 05 004081 001 | 200 |
| 05 003583 001 | 186 | 05 003684 001 | 223 | 05 003831 001 | 204 | 05 004090 001 | 194 |
| 05 003584 001 | 187 | 05 003685 001 | 223 | 05 003832 001 | 204 | 05 004095 001 | 194 |
| 05 003585 001 | 187 | 05 003690 001 | 223 | 05 003833 001 | 204 | 05 004201 001 | 205 |
| 05 003590 001 | 186 | 05 003692 001 | 212 | 05 003834 001 | 204 | 05 004202 001 | 204 |
| 05 003591 001 | 186 | 05 003695 001 | 212 | 05 003835 001 | 204 | 05 004203 001 | 203 |
| 05 003592 001 | 186 | 05 003696 001 | 213 | 05 003836 001 | 204 | 05 004210 001 | 206 |
| 05 003594 001 | 173 | 05 003697 001 | 213 | 05 003837 001 | 204 | 05 004211 001 | 204 |
| 05 003596 001 | 174 | 05 003717 001 | 156 | 05 003838 001 | 204 | 05 004212 001 | 205 |
| 05 003600 001 | 192 | 05 003718 001 | 156 | 05 003840 001 | 206 | 05 004310 001 | 105 |
| 05 003601 001 | 202 | 05 003719 001 | 156 | 05 003841 001 | 206 | 05 004313 001 | 46 |
| 05 003602 001 | 202 | 05 003720 001 | 156 | 05 003842 001 | 206 | 05 004350 001 | 300 |
| 05 003603 001 | 202 | 05 003721 001 | 156 | 05 003843 001 | 206 | 05 004351 001 | 300 |
| 05 003604 001 | 202 | 05 003722 001 | 156 | 05 003844 001 | 206 | 05 004352 001 | 300 |
| 05 003605 001 | 202 | 05 003723 001 | 156 | 05 003845 001 | 206 | 05 004353 001 | 300 |
| 05 003606 001 | 202 | 05 003724 001 | 156 | 05 003850 001 | 204 | 05 004354 001 | 301 |
| 05 003607 001 | 202 | 05 003725 001 | 156 | 05 003851 001 | 204 | 05 004355 001 | 301 |

Code No. Index

| Code No. | Page | Code No. | Page | Code No. | Page | Code No. | Page |
|---------------|------|---------------|------|---------------|------|---------------|------|
| 05 004650 001 | 99 | 05 006162 001 | 96 | 05 008710 001 | 36 | 05 013362 001 | 76 |
| 05 004655 001 | 99 | 05 006163 001 | 96 | 05 008712 001 | 36 | 05 013364 001 | 76 |
| 05 004660 001 | 99 | 05 006164 001 | 96 | 05 008715 001 | 36 | 05 013366 001 | 76 |
| 05 004665 001 | 99 | 05 006165 001 | 96 | 05 008720 001 | 36 | 05 013368 001 | 76 |
| 05 004670 001 | 99 | 05 006166 001 | 96 | 05 008723 001 | 36 | 05 013370 001 | 76 |
| 05 004675 001 | 99 | 05 006168 001 | 96 | 05 008725 001 | 36 | 05 013372 001 | 76 |
| 05 004780 001 | 100 | 05 006169 001 | 99 | 05 008730 001 | 36 | 05 013374 001 | 76 |
| 05 004781 001 | 100 | 05 006170 001 | 99 | 05 008735 001 | 36 | 05 013376 001 | 76 |
| 05 004782 001 | 100 | 05 006172 001 | 99 | 05 008740 001 | 36 | 05 013390 001 | 77 |
| 05 004783 001 | 100 | 05 006174 001 | 99 | 05 008750 001 | 36 | 05 013399 001 | 77 |
| 05 004784 001 | 100 | 05 006176 001 | 99 | 05 008751 001 | 36 | 05 013400 001 | 77 |
| 05 004950 001 | 126 | 05 006177 001 | 99 | 05 008752 001 | 36 | 05 013401 001 | 77 |
| 05 004951 001 | 126 | 05 006178 001 | 99 | 05 008753 001 | 36 | 05 013402 001 | 77 |
| 05 004952 001 | 126 | 05 006179 001 | 99 | 05 008775 001 | 44 | 05 013403 001 | 77 |
| 05 004953 001 | 126 | 05 006181 001 | 99 | 05 008780 001 | 44 | 05 013404 001 | 77 |
| 05 004954 001 | 126 | 05 006182 001 | 99 | 05 008782 001 | 44 | 05 013405 001 | 77 |
| 05 004955 001 | 126 | 05 006183 001 | 99 | 05 009305 001 | 37 | 05 013407 001 | 77 |
| 05 004956 001 | 126 | 05 006184 001 | 99 | 05 009310 001 | 37 | 05 013409 001 | 77 |
| 05 004957 001 | 126 | 05 006186 001 | 99 | 05 009312 001 | 37 | 05 013411 001 | 77 |
| 05 004958 001 | 126 | 05 006190 001 | 98 | 05 009313 001 | 37 | 05 017005 001 | 28 |
| 05 004959 001 | 126 | 05 006191 001 | 98 | 05 009315 001 | 37 | 05 017010 001 | 28 |
| 05 004960 001 | 126 | 05 006380 001 | 97 | 05 009317 001 | 37 | 05 017015 001 | 28 |
| 05 004961 001 | 126 | 05 006381 001 | 97 | 05 009319 001 | 37 | 05 017020 001 | 28 |
| 05 004962 001 | 126 | 05 006440 001 | 94 | 05 009320 001 | 37 | 05 017040 001 | 28 |
| 05 004963 001 | 126 | 05 006441 001 | 94 | 05 009325 001 | 37 | 05 017041 001 | 28 |
| 05 004964 001 | 128 | 05 006442 001 | 94 | 05 009330 001 | 44 | 05 017050 001 | 29 |
| 05 004965 001 | 128 | 05 006450 001 | 96 | 05 009335 001 | 44 | 05 017052 001 | 29 |
| 05 004966 001 | 126 | 05 006451 001 | 96 | 05 009337 001 | 44 | 05 017054 001 | 29 |
| 05 004970 001 | 129 | 05 006455 001 | 98 | 05 009340 001 | 37 | 05 017056 001 | 29 |
| 05 005300 001 | 100 | 05 006456 001 | 98 | 05 009341 001 | 37 | 05 017205 001 | 257 |
| 05 005305 001 | 100 | 05 006460 001 | 97 | 05 009342 001 | 37 | 05 017305 001 | 257 |
| 05 005310 001 | 100 | 05 006461 001 | 97 | 05 009343 001 | 37 | 05 017405 001 | 257 |
| 05 005315 001 | 100 | 05 006465 001 | 98 | 05 013300 001 | 76 | 05 017410 001 | 257 |
| 05 005320 001 | 100 | 05 006466 001 | 98 | 05 013301 001 | 76 | 05 017415 001 | 257 |
| 05 005325 001 | 100 | 05 006480 001 | 104 | 05 013302 001 | 76 | 05 018005 001 | 60 |
| 05 005330 001 | 100 | 05 007355 001 | 35 | 05 013303 001 | 76 | 05 018010 001 | 60 |
| 05 005335 001 | 100 | 05 007610 001 | 34 | 05 013304 001 | 76 | 05 018015 001 | 60 |
| 05 005340 001 | 100 | 05 007620 001 | 34 | 05 013305 001 | 76 | 05 018020 001 | 60 |
| 05 005655 001 | 101 | 05 007621 001 | 34 | 05 013306 001 | 76 | 05 018025 001 | 60 |
| 05 006100 001 | 94 | 05 007635 001 | 34 | 05 013307 001 | 76 | 05 018030 001 | 60 |
| 05 006105 001 | 94 | 05 007640 001 | 34 | 05 013308 001 | 76 | 05 018035 001 | 60 |
| 05 006110 001 | 94 | 05 007670 001 | 34 | 05 013309 001 | 76 | 05 018040 001 | 60 |
| 05 006115 001 | 94 | 05 007671 001 | 34 | 05 013310 001 | 76 | 05 018251 001 | 60 |
| 05 006116 001 | 94 | 05 007672 001 | 34 | 05 013311 001 | 76 | 05 018260 001 | 28 |
| 05 006120 001 | 94 | 05 007673 001 | 34 | 05 013312 001 | 76 | 05 018262 001 | 28 |
| 05 006121 001 | 94 | 05 007674 001 | 34 | 05 013314 001 | 76 | 05 018264 001 | 28 |
| 05 006125 001 | 94 | 05 007675 001 | 34 | 05 013330 001 | 76 | 05 018266 001 | 28 |
| 05 006126 001 | 94 | 05 007676 001 | 34 | 05 013331 001 | 76 | 05 018268 001 | 28 |
| 05 006130 001 | 94 | 05 007677 001 | 34 | 05 013332 001 | 76 | 05 018270 001 | 28 |
| 05 006135 001 | 94 | 05 007680 001 | 48 | 05 013333 001 | 76 | 05 018272 001 | 28 |
| 05 006140 001 | 94 | 05 007681 001 | 48 | 05 013334 001 | 76 | 05 018274 001 | 28 |
| 05 006145 001 | 102 | 05 008006 001 | 34 | 05 013335 001 | 76 | 05 018282 001 | 30 |
| 05 006147 001 | 102 | 05 008007 001 | 34 | 05 013337 001 | 76 | 05 018283 001 | 30 |
| 05 006148 001 | 103 | 05 008008 001 | 34 | 05 013338 001 | 76 | 05 018287 001 | 31 |
| 05 006150 001 | 95 | 05 008009 001 | 34 | 05 013339 001 | 76 | 05 018300 001 | 28 |
| 05 006152 001 | 95 | 05 008015 001 | 34 | 05 013341 001 | 76 | 05 018301 001 | 28 |
| 05 006153 001 | 95 | 05 008027 001 | 34 | 05 013350 001 | 76 | 05 018302 001 | 28 |
| 05 006154 001 | 95 | 05 008055 001 | 34 | 05 013352 001 | 76 | 05 018350 001 | 60 |
| 05 006156 001 | 95 | 05 008060 001 | 34 | 05 013354 001 | 76 | 05 018352 001 | 60 |
| 05 006158 001 | 95 | 05 008061 001 | 34 | 05 013356 001 | 76 | 05 018354 001 | 60 |
| 05 006159 001 | 95 | 05 008705 001 | 36 | 05 013358 001 | 76 | 05 018355 001 | 60 |
| 05 006160 001 | 96 | 05 008706 001 | 36 | 05 013360 001 | 76 | 05 020012 001 | 229 |

| Code No. | Page | Code No. | Page | Code No. | Page | Code No. | Page |
|-----------|---------|-----------|---------|-----------|---------|-----------|---------|
| 05 020013 | 001 228 | 05 021640 | 001 248 | 05 022630 | 001 247 | 05 022920 | 001 38 |
| 05 020022 | 001 229 | 05 021645 | 001 248 | 05 022631 | 001 247 | 05 022925 | 001 38 |
| 05 020064 | 001 230 | 05 021728 | 001 245 | 05 022632 | 001 247 | 05 022930 | 001 38 |
| 05 020065 | 001 230 | 05 021737 | 001 244 | 05 022633 | 001 247 | 05 022935 | 001 38 |
| 05 020066 | 001 230 | 05 021909 | 001 242 | 05 022634 | 001 247 | 05 023105 | 001 38 |
| 05 020067 | 001 230 | 05 022040 | 001 248 | 05 022635 | 001 247 | 05 023107 | 001 38 |
| 05 020068 | 001 230 | 05 022041 | 001 248 | 05 022636 | 001 247 | 05 023110 | 001 38 |
| 05 020069 | 001 230 | 05 022042 | 001 248 | 05 022637 | 001 247 | 05 023115 | 001 38 |
| 05 020070 | 001 230 | 05 022043 | 001 248 | 05 022638 | 001 247 | 05 023120 | 001 38 |
| 05 020071 | 001 230 | 05 022044 | 001 248 | 05 022639 | 001 241 | 05 023125 | 001 38 |
| 05 020072 | 001 230 | 05 022045 | 001 248 | 05 022660 | 001 246 | 05 023130 | 001 38 |
| 05 020073 | 001 230 | 05 022046 | 001 248 | 05 022661 | 001 246 | 05 023305 | 001 60 |
| 05 020074 | 001 230 | 05 022047 | 001 248 | 05 022662 | 001 246 | 05 023307 | 001 60 |
| 05 020075 | 001 230 | 05 022048 | 001 248 | 05 022663 | 001 246 | 05 023309 | 001 60 |
| 05 020076 | 001 230 | 05 022050 | 001 247 | 05 022664 | 001 246 | 05 024001 | 001 256 |
| 05 020077 | 001 230 | 05 022052 | 001 247 | 05 022665 | 001 246 | 05 024002 | 001 256 |
| 05 020078 | 001 230 | 05 022054 | 001 247 | 05 022666 | 001 246 | 05 024003 | 001 256 |
| 05 020079 | 001 230 | 05 022056 | 001 247 | 05 022667 | 001 246 | 05 024004 | 001 256 |
| 05 020080 | 001 230 | 05 022058 | 001 247 | 05 022668 | 001 246 | 05 024005 | 001 256 |
| 05 020081 | 001 230 | 05 022060 | 001 247 | 05 022669 | 001 238 | 05 024008 | 001 256 |
| 05 020082 | 001 230 | 05 022062 | 001 247 | 05 022700 | 001 246 | 05 024010 | 001 256 |
| 05 020090 | 001 231 | 05 022063 | 001 247 | 05 022701 | 001 246 | 05 024012 | 001 256 |
| 05 020091 | 001 232 | 05 022064 | 001 247 | 05 022702 | 001 246 | 05 024013 | 001 256 |
| 05 020092 | 001 231 | 05 022066 | 001 247 | 05 022703 | 001 246 | 05 024015 | 001 256 |
| 05 020093 | 001 232 | 05 022067 | 001 247 | 05 022704 | 001 246 | 05 024020 | 001 256 |
| 05 020129 | 001 94 | 05 022068 | 001 248 | 05 022705 | 001 246 | 05 024100 | 001 256 |
| 05 020131 | 001 96 | 05 022070 | 001 248 | 05 022706 | 001 246 | 05 024105 | 001 256 |
| 05 020132 | 001 98 | 05 022071 | 001 248 | 05 022708 | 001 246 | 05 024160 | 001 256 |
| 05 020133 | 001 96 | 05 022072 | 001 248 | 05 022709 | 001 246 | 05 024161 | 001 256 |
| 05 020134 | 001 98 | 05 022073 | 001 248 | 05 022710 | 001 246 | 05 024162 | 001 256 |
| 05 021005 | 001 249 | 05 022074 | 001 248 | 05 022711 | 001 246 | 05 024163 | 001 256 |
| 05 021010 | 001 249 | 05 022076 | 001 248 | 05 022712 | 001 246 | 05 024164 | 001 256 |
| 05 021015 | 001 249 | 05 022078 | 001 248 | 05 022713 | 001 246 | 05 024165 | 001 256 |
| 05 021020 | 001 249 | 05 022079 | 001 248 | 05 022714 | 001 246 | 05 024166 | 001 256 |
| 05 021025 | 001 249 | 05 022080 | 001 248 | 05 022715 | 001 246 | 05 024167 | 001 256 |
| 05 021030 | 001 249 | 05 022081 | 001 248 | 05 022716 | 001 246 | 05 024168 | 001 256 |
| 05 021035 | 001 249 | 05 022082 | 001 248 | 05 022717 | 001 246 | 05 024170 | 001 254 |
| 05 021040 | 001 249 | 05 022086 | 001 244 | 05 022718 | 001 246 | 05 024171 | 001 254 |
| 05 021045 | 001 249 | 05 022087 | 001 242 | 05 022720 | 001 238 | 05 024172 | 001 254 |
| 05 021050 | 001 249 | 05 022089 | 001 240 | 05 022721 | 001 239 | 05 024173 | 001 254 |
| 05 021055 | 001 249 | 05 022095 | 001 248 | 05 022728 | 001 91 | 05 024174 | 001 254 |
| 05 021060 | 001 249 | 05 022096 | 001 248 | 05 022729 | 001 90 | 05 024175 | 001 254 |
| 05 021065 | 001 249 | 05 022101 | 001 244 | 05 022730 | 001 90 | 05 024176 | 001 254 |
| 05 021070 | 001 249 | 05 022171 | 001 245 | 05 022731 | 001 90 | 05 024177 | 001 254 |
| 05 021075 | 001 249 | 05 022181 | 001 244 | 05 022732 | 001 90 | 05 024178 | 001 254 |
| 05 021080 | 001 249 | 05 022200 | 001 246 | 05 022733 | 001 90 | 05 024179 | 001 250 |
| 05 021085 | 001 249 | 05 022201 | 001 246 | 05 022734 | 001 90 | 05 024199 | 001 256 |
| 05 021090 | 001 249 | 05 022202 | 001 246 | 05 022740 | 001 90 | 05 024200 | 001 256 |
| 05 021095 | 001 249 | 05 022203 | 001 246 | 05 022741 | 001 90 | 05 024202 | 001 256 |
| 05 021100 | 001 249 | 05 022204 | 001 246 | 05 022745 | 001 91 | 05 024204 | 001 256 |
| 05 021105 | 001 249 | 05 022205 | 001 246 | 05 022795 | 001 38 | 05 024206 | 001 256 |
| 05 021110 | 001 249 | 05 022210 | 001 240 | 05 022800 | 001 38 | 05 024208 | 001 256 |
| 05 021406 | 001 243 | 05 022534 | 001 241 | 05 022805 | 001 38 | 05 024210 | 001 256 |
| 05 021600 | 001 248 | 05 022600 | 001 247 | 05 022810 | 001 38 | 05 024242 | 001 252 |
| 05 021605 | 001 248 | 05 022602 | 001 247 | 05 022815 | 001 38 | 05 024244 | 001 250 |
| 05 021610 | 001 248 | 05 022604 | 001 247 | 05 022820 | 001 38 | 05 024335 | 001 212 |
| 05 021615 | 001 248 | 05 022606 | 001 247 | 05 022825 | 001 38 | 05 024350 | 001 254 |
| 05 021620 | 001 248 | 05 022608 | 001 247 | 05 022830 | 001 38 | 05 024351 | 001 254 |
| 05 021625 | 001 248 | 05 022610 | 001 247 | 05 022835 | 001 38 | 05 024352 | 001 254 |
| 05 021630 | 001 248 | 05 022612 | 001 247 | 05 022905 | 001 38 | 05 024353 | 001 254 |
| 05 021632 | 001 248 | 05 022614 | 001 247 | 05 022910 | 001 38 | 05 024354 | 001 254 |
| 05 021635 | 001 248 | 05 022616 | 001 247 | 05 022915 | 001 38 | 05 024355 | 001 254 |

Code No. Index

| Code No. | Page | Code No. | Page | Code No. | Page | Code No. | Page |
|-----------|---------|-----------|---------|-----------|---------|-----------|--------|
| 05 024356 | 001 254 | 05 027101 | 001 247 | 05 028033 | 001 40 | 05 029463 | 001 43 |
| 05 024357 | 001 254 | 05 027102 | 001 247 | 05 028034 | 001 40 | 05 029464 | 001 43 |
| 05 024358 | 001 254 | 05 027103 | 001 247 | 05 028035 | 001 40 | 05 029465 | 001 43 |
| 05 024400 | 001 29 | 05 027104 | 001 247 | 05 028036 | 001 40 | 05 029466 | 001 43 |
| 05 024401 | 001 29 | 05 027105 | 001 247 | 05 028037 | 001 40 | 05 029501 | 001 43 |
| 05 024402 | 001 29 | 05 027106 | 001 247 | 05 028038 | 001 40 | 05 029502 | 001 43 |
| 05 024403 | 001 29 | 05 027107 | 001 247 | 05 028040 | 001 486 | 05 029503 | 001 43 |
| 05 024404 | 001 29 | 05 027108 | 001 247 | 05 028041 | 001 486 | 05 029504 | 001 43 |
| 05 024405 | 001 29 | 05 027109 | 001 247 | 05 028042 | 001 486 | 05 029505 | 001 43 |
| 05 024410 | 001 31 | 05 027110 | 001 247 | 05 028043 | 001 486 | 05 029506 | 001 43 |
| 05 024450 | 001 250 | 05 027111 | 001 247 | 05 028044 | 001 486 | 05 029507 | 001 43 |
| 05 024451 | 001 254 | 05 027201 | 001 249 | 05 028045 | 001 486 | 05 029510 | 001 51 |
| 05 024452 | 001 254 | 05 027202 | 001 249 | 05 028046 | 001 487 | 05 030080 | 001 82 |
| 05 024453 | 001 254 | 05 027203 | 001 249 | 05 028048 | 001 38 | 05 030081 | 001 82 |
| 05 024454 | 001 254 | 05 027204 | 001 249 | 05 028049 | 001 38 | 05 030082 | 001 82 |
| 05 024455 | 001 254 | 05 027205 | 001 249 | 05 028050 | 001 38 | 05 030083 | 001 82 |
| 05 024456 | 001 254 | 05 027206 | 001 249 | 05 028051 | 001 38 | 05 030084 | 001 82 |
| 05 024457 | 001 254 | 05 027207 | 001 249 | 05 028052 | 001 38 | 05 030100 | 001 80 |
| 05 024458 | 001 254 | 05 027208 | 001 249 | 05 028053 | 001 38 | 05 030101 | 001 80 |
| 05 024459 | 001 254 | 05 027209 | 001 249 | 05 028054 | 001 38 | 05 030102 | 001 80 |
| 05 024460 | 001 252 | 05 027210 | 001 249 | 05 028055 | 001 38 | 05 030103 | 001 80 |
| 05 024461 | 001 256 | 05 027211 | 001 249 | 05 028056 | 001 38 | 05 030104 | 001 80 |
| 05 024462 | 001 256 | 05 027212 | 001 249 | 05 028059 | 001 50 | 05 030105 | 001 80 |
| 05 024463 | 001 256 | 05 027213 | 001 249 | 05 028062 | 001 51 | 05 030106 | 001 80 |
| 05 024464 | 001 256 | 05 027214 | 001 249 | 05 028070 | 001 38 | 05 030107 | 001 80 |
| 05 024465 | 001 256 | 05 027215 | 001 249 | 05 028071 | 001 38 | 05 030108 | 001 80 |
| 05 024466 | 001 256 | 05 027405 | 001 62 | 05 028072 | 001 38 | 05 030110 | 001 80 |
| 05 024467 | 001 256 | 05 027455 | 001 62 | 05 028073 | 001 38 | 05 030111 | 001 80 |
| 05 024468 | 001 256 | 05 027456 | 001 69 | 05 028074 | 001 50 | 05 030112 | 001 80 |
| 05 024469 | 001 256 | 05 027910 | 001 486 | 05 028116 | 001 42 | 05 030115 | 001 80 |
| 05 024470 | 001 250 | 05 027911 | 001 486 | 05 028118 | 001 42 | 05 030116 | 001 80 |
| 05 024471 | 001 253 | 05 027912 | 001 486 | 05 028120 | 001 42 | 05 030117 | 001 80 |
| 05 024472 | 001 253 | 05 027913 | 001 486 | 05 028122 | 001 42 | 05 030118 | 001 80 |
| 05 024473 | 001 253 | 05 027930 | 001 486 | 05 028124 | 001 42 | 05 030119 | 001 80 |
| 05 024474 | 001 253 | 05 027931 | 001 486 | 05 028126 | 001 42 | 05 030120 | 001 81 |
| 05 024475 | 001 253 | 05 027932 | 001 486 | 05 028130 | 001 40 | 05 030121 | 001 81 |
| 05 024476 | 001 253 | 05 027933 | 001 486 | 05 028132 | 001 40 | 05 030122 | 001 81 |
| 05 024477 | 001 253 | 05 027934 | 001 486 | 05 028134 | 001 40 | 05 030127 | 001 81 |
| 05 024478 | 001 253 | 05 027935 | 001 486 | 05 028136 | 001 40 | 05 030128 | 001 81 |
| 05 024479 | 001 253 | 05 027936 | 001 487 | 05 028148 | 001 42 | 05 030129 | 001 81 |
| 05 024480 | 001 251 | 05 027950 | 001 40 | 05 028150 | 001 42 | 05 030130 | 001 81 |
| 05 024481 | 001 254 | 05 027952 | 001 40 | 05 028152 | 001 42 | 05 030131 | 001 81 |
| 05 024482 | 001 254 | 05 027954 | 001 40 | 05 028160 | 001 287 | 05 030135 | 001 81 |
| 05 024483 | 001 254 | 05 027956 | 001 40 | 05 028205 | 001 42 | 05 030150 | 001 82 |
| 05 024484 | 001 253 | 05 027958 | 001 40 | 05 028210 | 001 42 | 05 030151 | 001 82 |
| 05 024485 | 001 253 | 05 028000 | 001 39 | 05 028215 | 001 42 | 05 030160 | 001 68 |
| 05 024486 | 001 253 | 05 028001 | 001 39 | 05 028220 | 001 42 | 05 030170 | 001 82 |
| 05 024487 | 001 253 | 05 028002 | 001 39 | 05 028225 | 001 42 | 05 030180 | 001 82 |
| 05 024488 | 001 253 | 05 028003 | 001 39 | 05 028230 | 001 42 | 05 030181 | 001 72 |
| 05 024489 | 001 253 | 05 028004 | 001 39 | 05 029405 | 001 42 | 05 030400 | 001 80 |
| 05 026350 | 001 61 | 05 028005 | 001 39 | 05 029410 | 001 42 | 05 030401 | 001 80 |
| 05 026351 | 001 61 | 05 028008 | 001 39 | 05 029415 | 001 42 | 05 030402 | 001 80 |
| 05 026352 | 001 61 | 05 028010 | 001 39 | 05 029420 | 001 42 | 05 030403 | 001 80 |
| 05 026353 | 001 61 | 05 028012 | 001 39 | 05 029425 | 001 42 | 05 030404 | 001 80 |
| 05 026354 | 001 61 | 05 028013 | 001 39 | 05 029430 | 001 42 | 05 030405 | 001 80 |
| 05 026360 | 001 61 | 05 028015 | 001 39 | 05 029435 | 001 42 | 05 030406 | 001 80 |
| 05 026361 | 001 61 | 05 028020 | 001 39 | 05 029440 | 001 42 | 05 030410 | 001 82 |
| 05 026363 | 001 61 | 05 028025 | 001 39 | 05 029445 | 001 42 | 05 030411 | 001 82 |
| 05 026372 | 001 61 | 05 028029 | 001 40 | 05 029450 | 001 42 | 05 030412 | 001 82 |
| 05 026373 | 001 61 | 05 028030 | 001 40 | 05 029460 | 001 43 | 05 030413 | 001 82 |
| 05 026374 | 001 61 | 05 028031 | 001 40 | 05 029461 | 001 43 | 05 030414 | 001 82 |
| 05 026382 | 001 61 | 05 028032 | 001 40 | 05 029462 | 001 43 | 05 030415 | 001 82 |

| Code No. | Page | Code No. | Page | Code No. | Page | Code No. | Page |
|---------------|------|---------------|------|---------------|---------------|---------------|------|
| 05 030416 001 | 82 | 05 031602 001 | 122 | 05 048680 001 | 418 | 05 053475 001 | 423 |
| 05 030417 001 | 82 | 05 031603 001 | 122 | 05 048681 001 | 418 | 05 053480 001 | 423 |
| 05 030418 001 | 82 | 05 031604 001 | 122 | 05 050005 001 | 159, 182, 203 | 05 053485 001 | 423 |
| 05 031400 001 | 54 | 05 031605 001 | 122 | 05 050205 001 | 427 | 05 053520 001 | 419 |
| 05 031401 001 | 54 | 05 031610 001 | 122 | 05 050210 001 | 427 | 05 053522 001 | 419 |
| 05 031402 001 | 54 | 05 031611 001 | 122 | 05 050215 001 | 427 | 05 053560 001 | 419 |
| 05 031403 001 | 54 | 05 031613 001 | 122 | 05 050220 001 | 427 | 05 053870 001 | 420 |
| 05 031405 001 | 54 | 05 031615 001 | 122 | 05 050510 001 | 427 | 05 053872 001 | 419 |
| 05 031406 001 | 54 | 05 032001 001 | 22 | 05 050650 001 | 427 | 05 053920 001 | 420 |
| 05 031408 001 | 54 | 05 032002 001 | 22 | 05 051005 001 | 287 | 05 053923 001 | 414 |
| 05 031409 001 | 54 | 05 032003 001 | 22 | 05 051010 001 | 45 | 05 055950 001 | 397 |
| 05 031411 001 | 54 | 05 032004 001 | 22 | 05 051011 001 | 46 | 05 055951 001 | 397 |
| 05 031412 001 | 54 | 05 032005 001 | 22 | 05 051016 001 | 264 | 05 055952 001 | 397 |
| 05 031413 001 | 54 | 05 032006 001 | 22 | 05 051019 001 | 264 | 05 055953 001 | 397 |
| 05 031416 001 | 54 | 05 032007 001 | 22 | 05 051021 001 | 264 | 05 056005 001 | 377 |
| 05 031420 001 | 54 | 05 032020 001 | 22 | 05 051023 001 | 264 | 05 056007 001 | 377 |
| 05 031421 001 | 54 | 05 032021 001 | 22 | 05 051024 001 | 266 | 05 056010 001 | 377 |
| 05 031422 001 | 54 | 05 032022 001 | 22 | 05 051025 001 | 266 | 05 056015 001 | 377 |
| 05 031424 001 | 54 | 05 032023 001 | 22 | 05 051030 001 | 290 | 05 056020 001 | 377 |
| 05 031425 001 | 54 | 05 032030 001 | 22 | 05 051031 001 | 290 | 05 056025 001 | 377 |
| 05 031426 001 | 54 | 05 032031 001 | 22 | 05 051040 001 | 288 | 05 056030 001 | 377 |
| 05 031427 001 | 54 | 05 032032 001 | 22 | 05 051041 001 | 288 | 05 056037 001 | 377 |
| 05 031440 001 | 54 | 05 032033 001 | 22 | 05 051042 001 | 272 | 05 056040 001 | 377 |
| 05 031441 001 | 54 | 05 032050 001 | 23 | 05 051043 001 | 84 | 05 056045 001 | 377 |
| 05 031442 001 | 54 | 05 032051 001 | 23 | 05 051045 001 | 150 | 05 056064 001 | 376 |
| 05 031444 001 | 54 | 05 032052 001 | 23 | 05 051105 001 | 287 | 05 056066 001 | 376 |
| 05 031445 001 | 54 | 05 032053 001 | 23 | 05 051106 001 | 85 | 05 056068 001 | 376 |
| 05 031447 001 | 54 | 05 032054 001 | 23 | 05 051205 001 | 287 | 05 056155 001 | 453 |
| 05 031460 001 | 54 | 05 032055 001 | 23 | 05 051272 001 | 284 | 05 056157 001 | 453 |
| 05 031461 001 | 54 | 05 032056 001 | 23 | 05 051273 001 | 84 | 05 056158 001 | 454 |
| 05 031463 001 | 54 | 05 032057 001 | 23 | 05 051274 001 | 287 | 05 056159 001 | 450 |
| 05 031466 001 | 54 | 05 032058 001 | 23 | 05 051276 001 | 70 | 05 056161 001 | 450 |
| 05 031500 001 | 55 | 05 032060 001 | 24 | 05 051461 001 | 288 | 05 056163 001 | 451 |
| 05 031501 001 | 55 | 05 032061 001 | 24 | 05 051462 001 | 284 | 05 056164 001 | 452 |
| 05 031502 001 | 55 | 05 032063 001 | 25 | 05 051464 001 | 83 | 05 056168 001 | 454 |
| 05 031503 001 | 55 | 05 032070 002 | 23 | 05 051465 001 | 284 | 05 056172 001 | 376 |
| 05 031504 001 | 55 | 05 032071 002 | 23 | 05 051482 001 | 285 | 05 056174 001 | 376 |
| 05 031505 001 | 55 | 05 040001 001 | 293 | 05 051500 001 | 420 | 05 056176 001 | 376 |
| 05 031506 001 | 55 | 05 040030 001 | 397 | 05 051501 001 | 420 | 05 056200 001 | 377 |
| 05 031507 001 | 55 | 05 040031 001 | 397 | 05 051502 001 | 420 | 05 056203 001 | 376 |
| 05 031508 001 | 55 | 05 040032 001 | 397 | 05 051610 001 | 286 | 05 056210 001 | 376 |
| 05 031509 001 | 55 | 05 040033 001 | 397 | 05 051615 001 | 286 | 05 056220 001 | 376 |
| 05 031510 001 | 55 | 05 040034 001 | 397 | 05 051620 001 | 286 | 05 056225 001 | 376 |
| 05 031511 001 | 55 | 05 040040 001 | 397 | 05 051835 001 | 292 | 05 056233 001 | 376 |
| 05 031512 001 | 55 | 05 040041 001 | 397 | 05 052490 001 | 417 | 05 056240 001 | 376 |
| 05 031551 001 | 56 | 05 040042 001 | 397 | 05 052500 001 | 416 | 05 056285 001 | 454 |
| 05 031552 001 | 56 | 05 040043 001 | 397 | 05 052502 001 | 415 | 05 056291 001 | 443 |
| 05 031553 001 | 56 | 05 040045 001 | 397 | 05 052503 001 | 416 | 05 056294 001 | 454 |
| 05 031554 001 | 56 | 05 040046 001 | 397 | 05 052504 001 | 416 | 05 056295 001 | 452 |
| 05 031575 001 | 122 | 05 040047 001 | 397 | 05 052505 001 | 421 | 05 056296 001 | 453 |
| 05 031576 001 | 123 | 05 040048 001 | 397 | 05 052575 001 | 421 | 05 056303 001 | 381 |
| 05 031580 001 | 122 | 05 040049 001 | 397 | 05 052625 001 | 421 | 05 056305 001 | 381 |
| 05 031581 001 | 122 | 05 042605 001 | 428 | 05 052655 001 | 421 | 05 056310 001 | 381 |
| 05 031582 001 | 122 | 05 042655 001 | 428 | 05 052725 001 | 421 | 05 056315 001 | 381 |
| 05 031583 001 | 122 | 05 042665 001 | 428 | 05 053175 001 | 424 | 05 056320 001 | 381 |
| 05 031584 001 | 122 | 05 042705 001 | 428 | 05 053275 001 | 424 | 05 056325 001 | 381 |
| 05 031585 001 | 122 | 05 042715 001 | 428 | 05 053425 001 | 422 | 05 056330 001 | 381 |
| 05 031587 001 | 122 | 05 042750 001 | 428 | 05 053455 001 | 422 | 05 056332 001 | 381 |
| 05 031588 001 | 122 | 05 042755 001 | 428 | 05 053457 001 | 422 | 05 056335 001 | 381 |
| 05 031589 001 | 122 | 05 042760 001 | 428 | 05 053458 001 | 422 | 05 056340 001 | 381 |
| 05 031600 001 | 122 | 05 042765 001 | 428 | 05 053459 001 | 422 | 05 056341 001 | 387 |
| 05 031601 001 | 122 | 05 042768 001 | 428 | 05 053460 001 | 423 | 05 056342 001 | 387 |

Code No. Index

| Code No. | Page | Code No. | Page | Code No. | Page | Code No. | Page |
|---------------|------|---------------|------|---------------|------|---------------|------|
| 05 056343 001 | 387 | 05 056714 001 | 340 | 05 057434 001 | 460 | 05 057672 001 | 390 |
| 05 056344 001 | 387 | 05 056720 001 | 340 | 05 057441 001 | 440 | 05 057675 001 | 410 |
| 05 056345 001 | 387 | 05 056722 001 | 340 | 05 057442 001 | 458 | 05 057676 001 | 410 |
| 05 056346 001 | 387 | 05 056724 001 | 340 | 05 057450 001 | 448 | 05 057680 001 | 434 |
| 05 056350 001 | 381 | 05 056805 001 | 342 | 05 057455 001 | 448 | 05 057682 001 | 434 |
| 05 056352 001 | 381 | 05 056810 001 | 342 | 05 057460 001 | 278 | 05 057683 001 | 434 |
| 05 056354 001 | 381 | 05 056812 001 | 342 | 05 057505 001 | 385 | 05 057684 001 | 435 |
| 05 056356 001 | 381 | 05 056815 001 | 342 | 05 057510 001 | 385 | 05 057688 001 | 435 |
| 05 056358 001 | 381 | 05 056820 001 | 342 | 05 057515 001 | 385 | 05 057690 001 | 434 |
| 05 056368 001 | 442 | 05 056825 001 | 342 | 05 057520 001 | 385 | 05 057691 001 | 436 |
| 05 056374 001 | 441 | 05 056835 001 | 342 | 05 057525 001 | 385 | 05 057692 001 | 436 |
| 05 056375 001 | 450 | 05 056910 001 | 341 | 05 057530 001 | 385 | 05 057693 001 | 436 |
| 05 056376 001 | 451 | 05 056915 001 | 341 | 05 057550 001 | 385 | 05 057694 001 | 436 |
| 05 056400 001 | 317 | 05 056925 001 | 341 | 05 057551 001 | 385 | 05 057695 001 | 436 |
| 05 056402 001 | 317 | 05 056937 001 | 342 | 05 057552 001 | 385 | 05 057705 001 | 332 |
| 05 056404 001 | 317 | 05 056938 001 | 342 | 05 057553 001 | 385 | 05 057710 001 | 332 |
| 05 056410 001 | 318 | 05 056939 001 | 342 | 05 057554 001 | 385 | 05 057715 001 | 332 |
| 05 056412 001 | 318 | 05 057110 001 | 276 | 05 057555 001 | 385 | 05 057720 001 | 332 |
| 05 056414 001 | 318 | 05 057111 001 | 276 | 05 057560 001 | 385 | 05 057725 001 | 332 |
| 05 056420 001 | 318 | 05 057115 001 | 452 | 05 057561 001 | 385 | 05 057750 001 | 324 |
| 05 056422 001 | 318 | 05 057116 001 | 444 | 05 057562 001 | 385 | 05 057751 001 | 318 |
| 05 056424 001 | 318 | 05 057117 001 | 441 | 05 057563 001 | 385 | 05 057752 001 | 316 |
| 05 056440 001 | 448 | 05 057122 001 | 448 | 05 057565 001 | 385 | 05 057753 001 | 321 |
| 05 056471 001 | 456 | 05 057150 001 | 400 | 05 057566 001 | 385 | 05 057760 001 | 342 |
| 05 056472 001 | 456 | 05 057151 001 | 400 | 05 057567 001 | 385 | 05 057761 001 | 340 |
| 05 056473 001 | 456 | 05 057152 001 | 400 | 05 057568 001 | 385 | 05 057762 001 | 340 |
| 05 056474 001 | 455 | 05 057153 001 | 400 | 05 057570 001 | 385 | 05 057763 001 | 338 |
| 05 056476 001 | 457 | 05 057160 001 | 400 | 05 057571 001 | 385 | 05 057770 001 | 356 |
| 05 056477 001 | 443 | 05 057161 001 | 400 | 05 057572 001 | 385 | 05 057771 001 | 354 |
| 05 056478 001 | 457 | 05 057162 001 | 400 | 05 057573 001 | 385 | 05 057772 001 | 352 |
| 05 056479 001 | 456 | 05 057163 001 | 400 | 05 057574 001 | 385 | 05 057773 001 | 356 |
| 05 056490 001 | 218 | 05 057210 001 | 379 | 05 057575 001 | 385 | 05 057774 001 | 354 |
| 05 056491 001 | 218 | 05 057213 001 | 379 | 05 057603 001 | 380 | 05 057775 001 | 352 |
| 05 056500 001 | 324 | 05 057223 001 | 379 | 05 057604 001 | 380 | 05 057776 001 | 352 |
| 05 056505 001 | 323 | 05 057225 001 | 379 | 05 057605 001 | 380 | 05 057790 001 | 389 |
| 05 056507 001 | 324 | 05 057230 001 | 379 | 05 057606 001 | 380 | 05 057908 001 | 449 |
| 05 056510 001 | 323 | 05 057235 001 | 379 | 05 057615 001 | 316 | 05 058005 001 | 348 |
| 05 056515 001 | 324 | 05 057240 001 | 379 | 05 057616 001 | 316 | 05 058010 001 | 348 |
| 05 056520 001 | 324 | 05 057250 001 | 379 | 05 057617 001 | 316 | 05 058015 001 | 348 |
| 05 056525 001 | 323 | 05 057255 001 | 379 | 05 057620 001 | 338 | 05 058020 001 | 348 |
| 05 056535 001 | 324 | 05 057402 001 | 447 | 05 057621 001 | 338 | 05 058025 001 | 348 |
| 05 056605 001 | 322 | 05 057404 001 | 447 | 05 057622 001 | 338 | 05 059030 001 | 111 |
| 05 056610 001 | 322 | 05 057412 001 | 446 | 05 057623 001 | 352 | 05 059291 001 | 108 |
| 05 056625 001 | 322 | 05 057414 001 | 446 | 05 057624 001 | 352 | 05 059293 001 | 270 |
| 05 056653 001 | 262 | 05 057415 001 | 446 | 05 057625 001 | 352 | 05 059294 001 | 272 |
| 05 056656 001 | 269 | 05 057416 001 | 445 | 05 057626 001 | 352 | 05 059295 001 | 272 |
| 05 056660 001 | 323 | 05 057417 001 | 435 | 05 057627 001 | 352 | 05 059297 001 | 273 |
| 05 056662 001 | 323 | 05 057418 001 | 220 | 05 057628 001 | 352 | 05 059298 001 | 268 |
| 05 056664 001 | 323 | 05 057420 001 | 440 | 05 057631 001 | 388 | 05 059299 001 | 268 |
| 05 056680 001 | 380 | 05 057421 001 | 444 | 05 057632 001 | 388 | 05 059305 001 | 378 |
| 05 056681 001 | 380 | 05 057422 001 | 459 | 05 057644 001 | 382 | 05 059307 001 | 378 |
| 05 056682 001 | 380 | 05 057423 001 | 458 | 05 057645 001 | 382 | 05 059310 001 | 378 |
| 05 056683 001 | 380 | 05 057424 001 | 460 | 05 057646 001 | 382 | 05 059315 001 | 378 |
| 05 056684 001 | 380 | 05 057425 001 | 438 | 05 057656 001 | 326 | 05 059320 001 | 378 |
| 05 056685 001 | 380 | 05 057426 001 | 459 | 05 057657 001 | 326 | 05 059325 001 | 378 |
| 05 056686 001 | 380 | 05 057427 001 | 459 | 05 057661 001 | 344 | 05 059330 001 | 378 |
| 05 056687 001 | 380 | 05 057428 001 | 449 | 05 057662 001 | 344 | 05 059335 001 | 378 |
| 05 056700 001 | 339 | 05 057429 001 | 449 | 05 057664 001 | 358 | 05 059337 001 | 378 |
| 05 056702 001 | 339 | 05 057430 001 | 440 | 05 057665 001 | 358 | 05 059340 001 | 378 |
| 05 056704 001 | 339 | 05 057431 001 | 444 | 05 057666 001 | 358 | 05 059345 001 | 378 |
| 05 056710 001 | 340 | 05 057432 001 | 458 | 05 057667 001 | 358 | 05 059450 001 | 378 |
| 05 056712 001 | 340 | 05 057433 001 | 458 | 05 057671 001 | 390 | 05 059451 001 | 378 |

| Code No. | Page | Code No. | Page | Code No. | Page | Code No. | Page |
|-----------|---------|-----------|---------|-----------|---------|-----------|---------|
| 05 066934 | 001 361 | 05 071090 | 001 367 | 05 072451 | 001 356 | 05 073342 | 001 381 |
| 05 066935 | 001 361 | 05 071091 | 001 367 | 05 072452 | 001 356 | 05 073344 | 001 381 |
| 05 066936 | 001 361 | 05 071092 | 001 367 | 05 073200 | 001 427 | 05 073346 | 001 356 |
| 05 066937 | 001 361 | 05 071094 | 001 367 | 05 073210 | 001 425 | 05 073357 | 001 422 |
| 05 066938 | 001 361 | 05 071097 | 001 390 | 05 073220 | 001 219 | 05 073370 | 001 341 |
| 05 066939 | 001 361 | 05 071098 | 001 390 | 05 073230 | 001 222 | 05 073371 | 001 341 |
| 05 066940 | 001 361 | 05 071099 | 001 390 | 05 073240 | 001 267 | 05 073372 | 001 341 |
| 05 066941 | 001 361 | 05 071100 | 001 414 | 05 073260 | 001 150 | 05 073373 | 001 341 |
| 05 066942 | 001 361 | 05 071101 | 001 382 | 05 073261 | 001 174 | 05 073375 | 001 356 |
| 05 066943 | 001 361 | 05 071102 | 001 382 | 05 073262 | 001 192 | 05 073376 | 001 356 |
| 05 066945 | 001 361 | 05 071103 | 001 382 | 05 073268 | 001 228 | 05 073380 | 001 342 |
| 05 066946 | 001 361 | 05 071104 | 001 382 | 05 073270 | 001 228 | 05 073391 | 001 242 |
| 05 066947 | 001 361 | 05 071105 | 001 382 | 05 073271 | 001 228 | 05 073401 | 001 422 |
| 05 066948 | 001 361 | 05 071106 | 001 382 | 05 073272 | 001 228 | 05 073403 | 001 62 |
| 05 066949 | 001 361 | 05 071107 | 001 382 | 05 073273 | 001 228 | 05 073404 | 001 454 |
| 05 066950 | 001 361 | 05 071108 | 001 382 | 05 073274 | 001 228 | 05 073406 | 001 452 |
| 05 071000 | 001 376 | 05 071109 | 001 438 | 05 073275 | 001 228 | 05 073410 | 001 450 |
| 05 071001 | 001 376 | 05 071110 | 001 438 | 05 073276 | 001 228 | 05 073416 | 001 451 |
| 05 071002 | 001 376 | 05 071116 | 001 270 | 05 073277 | 001 228 | 05 073418 | 001 442 |
| 05 071010 | 001 316 | 05 071117 | 001 271 | 05 073278 | 001 228 | 05 073419 | 001 445 |
| 05 071011 | 001 316 | 05 071222 | 001 401 | 05 073279 | 001 228 | 05 073420 | 001 414 |
| 05 071012 | 001 316 | 05 071223 | 001 401 | 05 073280 | 001 228 | 05 073421 | 001 415 |
| 05 071020 | 001 338 | 05 071224 | 001 401 | 05 073281 | 001 228 | 05 073495 | 001 402 |
| 05 071021 | 001 338 | 05 071225 | 001 401 | 05 073282 | 001 228 | 05 073500 | 001 402 |
| 05 071022 | 001 338 | 05 071228 | 001 401 | 05 073283 | 001 228 | 05 073501 | 001 402 |
| 05 071025 | 001 388 | 05 072014 | 001 511 | 05 073284 | 001 228 | 05 073502 | 001 402 |
| 05 071030 | 001 352 | 05 072017 | 001 511 | 05 073285 | 001 228 | 05 073503 | 001 402 |
| 05 071031 | 001 352 | 05 072050 | 001 377 | 05 073286 | 001 228 | 05 073504 | 001 402 |
| 05 071032 | 001 352 | 05 072055 | 001 377 | 05 073287 | 001 228 | 05 073505 | 001 402 |
| 05 071033 | 001 352 | 05 072057 | 001 377 | 05 073290 | 001 230 | 05 073506 | 001 402 |
| 05 071034 | 001 352 | 05 072059 | 001 377 | 05 073295 | 001 230 | 05 073507 | 001 402 |
| 05 071035 | 001 352 | 05 072061 | 001 377 | 05 073300 | 001 377 | 05 073508 | 001 402 |
| 05 071036 | 001 352 | 05 072063 | 001 377 | 05 073301 | 001 377 | 05 073509 | 001 402 |
| 05 071037 | 001 352 | 05 072065 | 001 377 | 05 073302 | 001 377 | 05 073510 | 001 402 |
| 05 071038 | 001 352 | 05 072070 | 001 324 | 05 073303 | 001 377 | 05 073511 | 001 417 |
| 05 071041 | 001 344 | 05 072072 | 001 324 | 05 073304 | 001 324 | 05 073512 | 001 322 |
| 05 071046 | 001 358 | 05 072074 | 001 324 | 05 073305 | 001 324 | 05 073513 | 001 322 |
| 05 071047 | 001 358 | 05 072080 | 001 342 | 05 073306 | 001 324 | 05 073514 | 001 322 |
| 05 071049 | 001 382 | 05 072082 | 001 342 | 05 073307 | 001 324 | 05 073515 | 001 322 |
| 05 071060 | 001 380 | 05 072084 | 001 342 | 05 073308 | 001 342 | 05 073516 | 001 341 |
| 05 071061 | 001 380 | 05 072400 | 001 324 | 05 073309 | 001 342 | 05 073517 | 001 341 |
| 05 071062 | 001 380 | 05 072401 | 001 324 | 05 073310 | 001 342 | 05 073518 | 001 341 |
| 05 071063 | 001 380 | 05 072402 | 001 324 | 05 073311 | 001 342 | 05 073519 | 001 341 |
| 05 071064 | 001 380 | 05 072403 | 001 343 | 05 073313 | 001 356 | 05 073520 | 001 330 |
| 05 071065 | 001 380 | 05 072404 | 001 343 | 05 073314 | 001 356 | 05 073521 | 001 330 |
| 05 071066 | 001 380 | 05 072405 | 001 343 | 05 073315 | 001 356 | 05 073522 | 001 330 |
| 05 071070 | 001 380 | 05 072406 | 001 356 | 05 073316 | 001 356 | 05 073523 | 001 347 |
| 05 071071 | 001 380 | 05 072407 | 001 356 | 05 073317 | 001 356 | 05 073524 | 001 347 |
| 05 071072 | 001 380 | 05 072408 | 001 356 | 05 073318 | 001 419 | 05 073525 | 001 347 |
| 05 071073 | 001 380 | 05 072409 | 001 356 | 05 073323 | 001 323 | 05 073526 | 001 360 |
| 05 071074 | 001 380 | 05 072410 | 001 356 | 05 073324 | 001 323 | 05 073527 | 001 360 |
| 05 071075 | 001 380 | 05 072411 | 001 356 | 05 073325 | 001 323 | 05 073528 | 001 360 |
| 05 071076 | 001 380 | 05 072412 | 001 356 | 05 073326 | 001 323 | 05 073529 | 001 360 |
| 05 071077 | 001 380 | 05 072440 | 001 324 | 05 073332 | 001 317 | 05 073530 | 001 360 |
| 05 071080 | 001 378 | 05 072441 | 001 324 | 05 073333 | 001 317 | 05 073531 | 001 360 |
| 05 071081 | 001 326 | 05 072443 | 001 343 | 05 073334 | 001 317 | 05 073534 | 001 446 |
| 05 071082 | 001 326 | 05 072444 | 001 343 | 05 073335 | 001 317 | 05 073536 | 001 453 |
| 05 071083 | 001 326 | 05 072446 | 001 356 | 05 073336 | 001 339 | 05 073537 | 001 454 |
| 05 071084 | 001 344 | 05 072447 | 001 356 | 05 073337 | 001 339 | 05 073538 | 001 455 |
| 05 071085 | 001 344 | 05 072448 | 001 356 | 05 073338 | 001 339 | 05 073540 | 001 284 |
| 05 071086 | 001 344 | 05 072449 | 001 356 | 05 073339 | 001 339 | 05 073541 | 001 285 |
| 05 071089 | 001 367 | 05 072450 | 001 356 | 05 073340 | 001 356 | 05 073544 | 001 238 |

Code No. Index

| Code No. | Page | Code No. | Page | Code No. | Page | Code No. | Page |
|-----------|---------|-----------|---------|-----------|---------|-----------|---------|
| 05 073593 | 001 240 | 05 073964 | 001 358 | 05 074822 | 001 481 | 05 078640 | 001 505 |
| 05 073594 | 001 243 | 05 073965 | 001 358 | 05 074822 | 010 481 | 05 078641 | 001 505 |
| 05 073596 | 001 244 | 05 073966 | 001 358 | 05 074824 | 001 481 | 05 078642 | 001 506 |
| 05 073598 | 001 252 | 05 073967 | 001 358 | 05 074824 | 010 481 | 05 078650 | 001 506 |
| 05 073599 | 001 252 | 05 073971 | 001 390 | 05 074826 | 001 483 | 05 078651 | 001 506 |
| 05 073610 | 001 316 | 05 073972 | 001 390 | 05 074826 | 010 483 | 05 078652 | 001 506 |
| 05 073611 | 001 316 | 05 073980 | 001 434 | 05 074828 | 001 483 | 05 078653 | 001 506 |
| 05 073612 | 001 316 | 05 073990 | 001 410 | 05 074828 | 010 483 | 05 078654 | 001 506 |
| 05 073613 | 001 338 | 05 074700 | 001 472 | 05 074840 | 001 481 | 05 078655 | 001 506 |
| 05 073614 | 001 338 | 05 074701 | 001 472 | 05 074840 | 010 481 | 05 078656 | 001 506 |
| 05 073615 | 001 338 | 05 074702 | 001 472 | 05 074842 | 001 481 | 05 078657 | 001 506 |
| 05 073616 | 001 414 | 05 074705 | 001 472 | 05 074842 | 010 481 | 05 078658 | 001 506 |
| 05 073620 | 001 352 | 05 074710 | 001 474 | 05 075604 | 001 492 | 05 078660 | 001 506 |
| 05 073621 | 001 352 | 05 074711 | 001 474 | 05 075605 | 001 492 | 05 078661 | 001 506 |
| 05 073622 | 001 352 | 05 074712 | 001 474 | 05 075610 | 001 494 | 05 078662 | 001 506 |
| 05 073623 | 001 352 | 05 074715 | 001 480 | 05 075611 | 001 494 | 05 078663 | 001 506 |
| 05 073624 | 001 352 | 05 074715 | 010 480 | 05 075620 | 001 495 | 05 078664 | 001 506 |
| 05 073625 | 001 352 | 05 074716 | 001 480 | 05 075621 | 001 495 | 05 078666 | 001 507 |
| 05 073626 | 001 352 | 05 074716 | 010 480 | 05 075622 | 001 496 | 05 078667 | 001 507 |
| 05 073630 | 001 438 | 05 074717 | 001 480 | 05 075623 | 001 496 | 05 078670 | 001 502 |
| 05 073634 | 001 439 | 05 074717 | 010 480 | 05 075624 | 001 497 | 05 078671 | 001 502 |
| 05 073635 | 001 455 | 05 074720 | 001 482 | 05 075630 | 001 497 | 05 078672 | 001 502 |
| 05 073637 | 001 456 | 05 074720 | 010 482 | 05 075651 | 001 498 | 05 078673 | 001 502 |
| 05 073638 | 001 456 | 05 074721 | 001 482 | 05 075652 | 001 498 | 05 078674 | 001 502 |
| 05 073640 | 001 216 | 05 074721 | 010 482 | 05 075653 | 001 499 | 05 078675 | 001 502 |
| 05 073645 | 001 220 | 05 074722 | 001 482 | 05 075654 | 001 499 | 05 078676 | 001 502 |
| 05 073660 | 001 290 | 05 074722 | 010 482 | 05 075655 | 001 500 | 05 078677 | 001 502 |
| 05 073661 | 002 290 | 05 074728 | 001 480 | 05 075656 | 001 500 | 05 078678 | 001 502 |
| 05 073665 | 001 289 | 05 074728 | 010 480 | 05 078200 | 001 504 | 05 078679 | 001 502 |
| 05 073670 | 001 85 | 05 074730 | 001 473 | 05 078205 | 001 505 | 05 078680 | 001 502 |
| 05 073671 | 001 85 | 05 074731 | 001 473 | 05 078210 | 001 505 | 05 078681 | 001 502 |
| 05 073675 | 001 70 | 05 074733 | 001 474 | 05 078345 | 001 505 | 05 078682 | 001 502 |
| 05 073676 | 001 71 | 05 074734 | 001 474 | 05 078600 | 001 502 | 05 078683 | 001 502 |
| 05 073677 | 001 70 | 05 074738 | 001 476 | 05 078601 | 001 502 | 05 078684 | 001 502 |
| 05 073680 | 001 63 | 05 074739 | 001 476 | 05 078602 | 001 502 | 05 078685 | 001 502 |
| 05 073681 | 001 63 | 05 074745 | 001 476 | 05 078603 | 001 502 | 05 078686 | 001 502 |
| 05 073720 | 001 360 | 05 074746 | 001 477 | 05 078604 | 001 502 | 05 078687 | 001 502 |
| 05 073721 | 001 360 | 05 074750 | 001 114 | 05 078605 | 001 502 | 05 078690 | 001 503 |
| 05 073722 | 001 360 | 05 074752 | 001 114 | 05 078606 | 001 502 | 05 078691 | 001 503 |
| 05 073723 | 001 360 | 05 074757 | 001 114 | 05 078607 | 001 502 | 05 078692 | 001 503 |
| 05 073724 | 001 360 | 05 074770 | 001 472 | 05 078608 | 001 502 | 05 078693 | 001 503 |
| 05 073890 | 001 436 | 05 074772 | 001 472 | 05 078609 | 001 502 | 05 078694 | 001 503 |
| 05 073904 | 001 380 | 05 074774 | 001 472 | 05 078610 | 001 502 | 05 078695 | 001 503 |
| 05 073905 | 001 380 | 05 074780 | 001 473 | 05 078611 | 001 502 | 05 078696 | 001 503 |
| 05 073906 | 001 380 | 05 074782 | 001 473 | 05 078612 | 001 502 | 05 078697 | 001 503 |
| 05 073916 | 001 316 | 05 074784 | 001 473 | 05 078620 | 001 503 | 05 078698 | 001 503 |
| 05 073917 | 001 316 | 05 074786 | 001 475 | 05 078621 | 001 503 | 05 078699 | 001 503 |
| 05 073921 | 001 338 | 05 074788 | 001 475 | 05 078622 | 001 503 | 05 078700 | 001 503 |
| 05 073922 | 001 338 | 05 074790 | 001 480 | 05 078623 | 001 503 | 05 078701 | 001 503 |
| 05 073924 | 001 352 | 05 074790 | 010 480 | 05 078624 | 001 503 | 05 078702 | 001 503 |
| 05 073925 | 001 352 | 05 074792 | 001 480 | 05 078625 | 001 503 | 05 078703 | 001 503 |
| 05 073926 | 001 352 | 05 074792 | 010 480 | 05 078626 | 001 503 | 05 078704 | 001 503 |
| 05 073927 | 001 352 | 05 074794 | 001 480 | 05 078627 | 001 503 | 05 078705 | 001 503 |
| 05 073931 | 001 388 | 05 074794 | 010 480 | 05 078628 | 001 503 | 05 078707 | 001 504 |
| 05 073932 | 001 388 | 05 074800 | 001 483 | 05 078629 | 001 503 | 05 078708 | 001 504 |
| 05 073944 | 001 382 | 05 074800 | 010 483 | 05 078630 | 001 503 | 05 078710 | 001 505 |
| 05 073945 | 001 382 | 05 074802 | 001 475 | 05 078631 | 001 503 | 05 078714 | 001 506 |
| 05 073946 | 001 382 | 05 074804 | 001 475 | 05 078632 | 001 503 | 05 078715 | 001 506 |
| 05 073956 | 001 326 | 05 074810 | 001 483 | 05 078633 | 001 503 | 05 078716 | 001 506 |
| 05 073957 | 001 326 | 05 074810 | 010 483 | 05 078635 | 001 504 | 05 078717 | 001 506 |
| 05 073961 | 001 344 | 05 074820 | 001 481 | 05 078636 | 001 504 | 05 078720 | 001 507 |
| 05 073962 | 001 344 | 05 074820 | 010 481 | 05 078637 | 001 504 | 05 078721 | 001 507 |

| Code No. | Page | Code No. | Page | Code No. | Page | Code No. | Page |
|---------------|------|---------------|------|---------------|------|---------------|------|
| 05 10000 001 | 94 | 05 104621 001 | 463 | 05 110055 001 | 35 | 05 118064 001 | 68 |
| 05 10001 001 | 94 | 05 104622 001 | 463 | 05 110068 001 | 44 | 05 118066 001 | 68 |
| 05 10002 001 | 94 | 05 104630 001 | 462 | 05 110069 001 | 44 | 05 118068 001 | 68 |
| 05 10003 001 | 94 | 05 104631 001 | 462 | 05 110070 001 | 44 | 05 118070 001 | 68 |
| 05 10004 001 | 94 | 05 104632 001 | 462 | 05 110075 001 | 44 | 05 118072 001 | 68 |
| 05 100011 001 | 95 | 05 104633 001 | 462 | 05 110078 001 | 44 | 05 118074 001 | 68 |
| 05 100012 001 | 95 | 05 104634 001 | 462 | 05 110104 001 | 34 | 05 118075 001 | 68 |
| 05 100015 001 | 96 | 05 104635 001 | 462 | 05 110105 001 | 34 | 05 118076 001 | 68 |
| 05 100016 001 | 96 | 05 104640 001 | 462 | 05 110150 001 | 35 | 05 118078 001 | 68 |
| 05 100019 001 | 97 | 05 104641 001 | 462 | 05 110151 001 | 35 | 05 118080 001 | 68 |
| 05 100020 001 | 97 | 05 104642 001 | 462 | 05 117680 001 | 41 | 05 118082 001 | 68 |
| 05 100021 001 | 98 | 05 104643 001 | 462 | 05 117681 001 | 41 | 05 118089 001 | 68 |
| 05 100022 001 | 98 | 05 104644 001 | 462 | 05 117682 001 | 41 | 05 118090 001 | 68 |
| 05 100024 001 | 100 | 05 104645 001 | 462 | 05 117683 001 | 41 | 05 118092 001 | 68 |
| 05 100025 001 | 100 | 05 104650 001 | 462 | 05 117684 001 | 41 | 05 118094 001 | 68 |
| 05 100026 001 | 100 | 05 104651 001 | 463 | 05 117685 001 | 41 | 05 118096 001 | 68 |
| 05 100030 001 | 35 | 05 104652 001 | 463 | 05 117686 001 | 41 | 05 118098 001 | 68 |
| 05 100031 001 | 35 | 05 104653 001 | 465 | 05 117687 001 | 41 | 05 118100 001 | 68 |
| 05 100042 001 | 34 | 05 104654 001 | 461 | 05 117688 001 | 41 | 05 118102 001 | 68 |
| 05 100043 001 | 34 | 05 104655 001 | 462 | 05 117689 001 | 41 | 05 118103 001 | 68 |
| 05 100044 001 | 34 | 05 104660 001 | 461 | 05 117691 001 | 41 | 05 118106 001 | 68 |
| 05 100050 001 | 36 | 05 104661 001 | 461 | 05 117990 001 | 66 | 05 118108 001 | 69 |
| 05 100051 001 | 36 | 05 104662 001 | 461 | 05 117991 001 | 66 | 05 118109 001 | 69 |
| 05 100052 001 | 36 | 05 104663 001 | 461 | 05 117992 001 | 66 | 05 118110 001 | 69 |
| 05 100055 001 | 37 | 05 104664 001 | 461 | 05 117993 001 | 66 | 05 118112 001 | 69 |
| 05 100056 001 | 37 | 05 104665 001 | 461 | 05 117994 001 | 66 | 05 118114 001 | 69 |
| 05 100057 001 | 37 | 05 104666 001 | 461 | 05 117995 001 | 66 | 05 118116 001 | 69 |
| 05 100060 001 | 39 | 05 104667 001 | 461 | 05 117997 001 | 66 | 05 118118 001 | 69 |
| 05 100061 001 | 39 | 05 104668 001 | 461 | 05 118000 001 | 66 | 05 118120 001 | 69 |
| 05 100062 001 | 39 | 05 104669 001 | 461 | 05 118002 001 | 66 | 05 118122 001 | 69 |
| 05 100063 001 | 39 | 05 104670 001 | 461 | 05 118003 001 | 66 | 05 118124 001 | 69 |
| 05 100064 001 | 39 | 05 104671 001 | 461 | 05 118004 001 | 66 | 05 118126 001 | 69 |
| 05 100070 001 | 41 | 05 104672 001 | 461 | 05 118005 001 | 66 | 05 118128 001 | 69 |
| 05 100071 001 | 41 | 05 104900 001 | 100 | 05 118006 001 | 66 | 05 118130 001 | 69 |
| 05 100072 001 | 41 | 05 104901 001 | 100 | 05 118007 001 | 66 | 05 118132 001 | 69 |
| 05 100075 001 | 28 | 05 104902 001 | 100 | 05 118008 001 | 66 | 05 118134 001 | 69 |
| 05 100076 001 | 28 | 05 104903 001 | 100 | 05 118010 001 | 66 | 05 118135 001 | 69 |
| 05 100077 001 | 28 | 05 104904 001 | 100 | 05 118012 001 | 66 | 05 118136 001 | 69 |
| 05 100080 001 | 29 | 05 104905 001 | 100 | 05 118014 001 | 66 | 05 118137 001 | 69 |
| 05 100081 001 | 29 | 05 104906 001 | 100 | 05 118017 001 | 66 | 05 118145 001 | 68 |
| 05 100082 001 | 29 | 05 104907 001 | 100 | 05 118019 001 | 66 | 05 118150 001 | 71 |
| 05 100085 001 | 28 | 05 105622 001 | 49 | 05 118020 001 | 66 | 05 118152 001 | 72 |
| 05 100086 001 | 28 | 05 105630 001 | 45 | 05 118022 001 | 66 | 05 118154 001 | 73 |
| 05 100087 001 | 28 | 05 105631 001 | 102 | 05 118023 001 | 66 | 05 118156 001 | 72 |
| 05 100100 001 | 101 | 05 105650 001 | 48 | 05 118024 001 | 66 | 05 118158 001 | 73 |
| 05 104600 001 | 463 | 05 105656 001 | 48 | 05 118026 001 | 66 | 05 118180 001 | 66 |
| 05 104601 001 | 463 | 05 110000 001 | 34 | 05 118030 001 | 66 | 05 118181 001 | 66 |
| 05 104602 001 | 463 | 05 110001 001 | 34 | 05 118032 001 | 66 | 05 118182 001 | 66 |
| 05 104603 001 | 463 | 05 110002 001 | 34 | 05 118035 001 | 67 | 05 118183 001 | 66 |
| 05 104604 001 | 463 | 05 110003 001 | 34 | 05 118036 001 | 67 | 05 118184 001 | 66 |
| 05 104605 001 | 463 | 05 110004 001 | 34 | 05 118037 001 | 67 | 05 118185 001 | 66 |
| 05 104610 001 | 463 | 05 110005 001 | 34 | 05 118039 001 | 67 | 05 118186 001 | 66 |
| 05 104611 001 | 463 | 05 110006 001 | 34 | 05 118040 001 | 67 | 05 133150 001 | 248 |
| 05 104612 001 | 463 | 05 110007 001 | 34 | 05 118042 001 | 67 | 05 133151 001 | 248 |
| 05 104613 001 | 463 | 05 110008 001 | 34 | 05 118044 001 | 67 | 05 133152 001 | 248 |
| 05 104614 001 | 463 | 05 110010 001 | 34 | 05 118046 001 | 67 | 05 133153 001 | 248 |
| 05 104615 001 | 463 | 05 110011 001 | 34 | 05 118048 001 | 67 | 05 133154 001 | 248 |
| 05 104616 001 | 463 | 05 110050 001 | 35 | 05 118050 001 | 67 | 05 133155 001 | 248 |
| 05 104617 001 | 463 | 05 110051 001 | 35 | 05 118052 001 | 67 | 05 133156 001 | 248 |
| 05 104618 001 | 463 | 05 110052 001 | 35 | 05 118054 001 | 67 | 05 133157 001 | 248 |
| 05 104619 001 | 463 | 05 110053 001 | 35 | 05 118060 001 | 68 | 05 133158 001 | 248 |
| 05 104620 001 | 463 | 05 110054 001 | 35 | 05 118062 001 | 68 | 05 133163 001 | 242 |

Code No. Index

| Code No. | Page | Code No. | Page | Code No. | Page | Code No. | Page |
|---------------|------|---------------|------|---------------|------|---------------|------|
| 05 133180 001 | 245 | 05 134683 001 | 369 | 05 135060 001 | 381 | 05 135235 001 | 370 |
| 05 133285 001 | 30 | 05 134684 001 | 369 | 05 135068 001 | 381 | 05 135264 001 | 379 |
| 05 133355 001 | 104 | 05 134685 001 | 369 | 05 135069 001 | 381 | 05 135265 001 | 379 |
| 05 133356 001 | 103 | 05 134686 001 | 369 | 05 135070 001 | 381 | 05 135266 001 | 379 |
| 05 133862 001 | 212 | 05 134687 001 | 369 | 05 135071 001 | 381 | 05 135267 001 | 379 |
| 05 134001 001 | 63 | 05 134688 001 | 369 | 05 135072 001 | 381 | 05 135268 001 | 386 |
| 05 134002 001 | 62 | 05 134690 001 | 369 | 05 135073 001 | 381 | 05 135269 001 | 386 |
| 05 134200 001 | 450 | 05 134691 001 | 369 | 05 135074 001 | 381 | 05 135270 001 | 335 |
| 05 134370 001 | 328 | 05 134695 001 | 368 | 05 135075 001 | 381 | 05 135271 001 | 335 |
| 05 134371 001 | 328 | 05 134698 001 | 372 | 05 135076 001 | 381 | 05 135272 001 | 335 |
| 05 134372 001 | 328 | 05 134699 001 | 372 | 05 135077 001 | 381 | 05 135273 001 | 335 |
| 05 134373 001 | 328 | 05 134700 001 | 372 | 05 135078 001 | 381 | 05 135274 001 | 335 |
| 05 134374 001 | 353 | 05 134701 001 | 372 | 05 135079 001 | 381 | 05 135275 001 | 335 |
| 05 134375 001 | 353 | 05 134702 001 | 372 | 05 135080 001 | 385 | 05 135276 001 | 335 |
| 05 134376 001 | 353 | 05 134703 001 | 372 | 05 135081 001 | 385 | 05 135277 001 | 335 |
| 05 134377 001 | 353 | 05 134704 001 | 372 | 05 135082 001 | 385 | 05 135278 001 | 335 |
| 05 134378 001 | 353 | 05 134705 001 | 372 | 05 135083 001 | 385 | 05 135280 001 | 335 |
| 05 134379 001 | 353 | 05 134706 001 | 372 | 05 135084 001 | 385 | 05 135281 001 | 335 |
| 05 134380 001 | 330 | 05 134707 001 | 372 | 05 135090 001 | 383 | 05 135284 001 | 335 |
| 05 134381 001 | 330 | 05 134720 001 | 373 | 05 135091 001 | 383 | 05 135285 001 | 335 |
| 05 134382 001 | 330 | 05 134722 001 | 373 | 05 135092 001 | 383 | 05 135286 001 | 335 |
| 05 134384 001 | 347 | 05 134723 001 | 373 | 05 135093 001 | 383 | 05 135287 001 | 335 |
| 05 134385 001 | 347 | 05 134732 001 | 373 | 05 135094 001 | 383 | 05 135288 001 | 335 |
| 05 134386 001 | 347 | 05 134740 001 | 360 | 05 135095 001 | 383 | 05 135289 001 | 335 |
| 05 134397 001 | 423 | 05 134800 001 | 391 | 05 135096 001 | 383 | 05 135290 001 | 335 |
| 05 134398 001 | 422 | 05 134801 001 | 391 | 05 135097 001 | 383 | 05 135291 001 | 335 |
| 05 134399 001 | 426 | 05 134802 001 | 391 | 05 135098 001 | 383 | 05 135380 001 | 336 |
| 05 134480 001 | 422 | 05 134805 001 | 391 | 05 135099 001 | 383 | 05 135381 001 | 336 |
| 05 134491 001 | 267 | 05 134806 001 | 391 | 05 135120 001 | 368 | 05 135382 001 | 336 |
| 05 134500 001 | 370 | 05 134807 001 | 391 | 05 135121 001 | 368 | 05 135383 001 | 336 |
| 05 134600 001 | 373 | 05 134905 001 | 324 | 05 135140 001 | 356 | 05 135384 001 | 336 |
| 05 134601 001 | 373 | 05 134906 001 | 328 | 05 135141 001 | 356 | 05 135385 001 | 336 |
| 05 134602 001 | 373 | 05 134907 001 | 328 | 05 135142 001 | 356 | 05 135386 001 | 336 |
| 05 134603 001 | 373 | 05 134908 001 | 328 | 05 135143 001 | 356 | 05 135387 001 | 336 |
| 05 134604 001 | 373 | 05 134909 001 | 328 | 05 135170 001 | 359 | 05 135400 001 | 364 |
| 05 134605 001 | 335 | 05 134910 001 | 328 | 05 135171 001 | 359 | 05 135401 001 | 364 |
| 05 134606 001 | 335 | 05 134911 001 | 328 | 05 135172 001 | 359 | 05 135402 001 | 364 |
| 05 134607 001 | 335 | 05 134912 001 | 328 | 05 135174 001 | 359 | 05 135403 001 | 364 |
| 05 134608 001 | 335 | 05 134913 001 | 328 | 05 135176 001 | 359 | 05 135404 001 | 364 |
| 05 134654 001 | 373 | 05 134914 001 | 328 | 05 135180 001 | 359 | 05 135405 001 | 364 |
| 05 134655 001 | 373 | 05 134915 001 | 328 | 05 135182 001 | 359 | 05 135406 001 | 364 |
| 05 134656 001 | 373 | 05 134919 001 | 318 | 05 135184 001 | 359 | 05 135407 001 | 364 |
| 05 134657 001 | 373 | 05 134920 001 | 318 | 05 135185 001 | 359 | 05 135408 001 | 364 |
| 05 134658 001 | 373 | 05 134921 001 | 318 | 05 135186 001 | 359 | 05 135409 001 | 364 |
| 05 134664 001 | 369 | 05 134929 001 | 328 | 05 135200 001 | 360 | 05 135420 001 | 365 |
| 05 134665 001 | 369 | 05 134930 001 | 328 | 05 135201 001 | 360 | 05 135421 001 | 365 |
| 05 134667 001 | 369 | 05 134931 001 | 328 | 05 135202 001 | 360 | 05 135422 001 | 365 |
| 05 134668 001 | 369 | 05 134932 001 | 328 | 05 135204 001 | 360 | 05 135423 001 | 365 |
| 05 134669 001 | 369 | 05 134940 001 | 318 | 05 135205 001 | 360 | 05 135424 001 | 365 |
| 05 134670 001 | 369 | 05 134941 001 | 318 | 05 135220 001 | 364 | 05 135425 001 | 365 |
| 05 134671 001 | 369 | 05 134942 001 | 318 | 05 135221 001 | 364 | 05 135430 001 | 370 |
| 05 134672 001 | 369 | 05 134950 001 | 328 | 05 135222 001 | 364 | 05 135431 001 | 370 |
| 05 134673 001 | 369 | 05 134951 001 | 328 | 05 135224 001 | 402 | 05 135432 001 | 370 |
| 05 134674 001 | 369 | 05 134952 001 | 328 | 05 135225 001 | 402 | 05 135433 001 | 370 |
| 05 134675 001 | 369 | 05 135003 001 | 340 | 05 135226 001 | 373 | 05 135434 001 | 370 |
| 05 134676 001 | 369 | 05 135005 001 | 321 | 05 135228 001 | 373 | 05 135435 001 | 370 |
| 05 134677 001 | 369 | 05 135008 001 | 319 | 05 135229 001 | 373 | 05 135436 001 | 370 |
| 05 134678 001 | 369 | 05 135009 001 | 321 | 05 135230 001 | 370 | 05 135440 001 | 370 |
| 05 134679 001 | 369 | 05 135017 001 | 340 | 05 135231 001 | 370 | 05 135441 001 | 370 |
| 05 134680 001 | 369 | 05 135040 001 | 325 | 05 135232 001 | 370 | 05 135442 001 | 370 |
| 05 134681 001 | 369 | 05 135041 001 | 325 | 05 135233 001 | 370 | 05 135443 001 | 370 |
| 05 134682 001 | 369 | 05 135042 001 | 325 | 05 135234 001 | 370 | 05 135530 001 | 330 |

| Code No. | Page | Code No. | Page | Code No. | Page | Code No. | Page |
|---------------|----------|---------------|------|---------------|------|---------------|------|
| 05 135531 001 | 330 | 05 160901 001 | 331 | 05 344511 001 | 428 | 05 347778 001 | 51 |
| 05 135532 001 | 330 | 05 160908 001 | 331 | 05 344512 001 | 428 | 05 350430 001 | 383 |
| 05 135705 001 | 332 | 05 160917 001 | 369 | 05 344513 001 | 428 | 05 350451 001 | 476 |
| 05 135706 001 | 332 | 05 160924 001 | 423 | 05 344514 001 | 428 | 05 380033 001 | 383 |
| 05 135810 001 | 453 | 05 160956 001 | 368 | 05 344515 001 | 393 | 05 380045 001 | 383 |
| 05 135902 001 | 403 | 05 160976 001 | 423 | 05 344536 001 | 76 | 05 380046 001 | 383 |
| 05 135903 001 | 403 | 05 160977 001 | 423 | 05 344537 001 | 76 | 05 380047 001 | 383 |
| 05 135904 001 | 403 | 05 160979 001 | 423 | 05 344538 001 | 76 | 05 380048 001 | 383 |
| 05 135906 001 | 108 | 05 160981 001 | 423 | 05 344540 001 | 76 | 05 380049 001 | 383 |
| 05 135918 001 | 217 | 05 160983 001 | 328 | 05 344541 001 | 76 | 05 380050 001 | 383 |
| 05 135926 001 | 280 | 05 160987 001 | 417 | 05 344542 001 | 76 | 05 380103 001 | 381 |
| 05 135927 001 | 282 | 05 160988 001 | 417 | 05 344543 001 | 76 | 05 380104 001 | 381 |
| 05 135928 001 | 281 | 05 200495 001 | 373 | 05 344544 001 | 76 | 05 380105 001 | 381 |
| 05 135938 001 | 71 | 05 200995 001 | 220 | 05 344545 001 | 76 | 05 380106 001 | 381 |
| 05 135939 001 | 280 | 05 204126 001 | 373 | 05 344546 001 | 76 | 05 380107 001 | 381 |
| 05 135942 001 | 262 | 05 221102 001 | 385 | 05 344900 001 | 370 | 05 380108 001 | 381 |
| 05 135949 001 | 146 | 05 221110 001 | 393 | 05 345018 001 | 364 | 05 380109 001 | 381 |
| 05 135961 001 | 104 | 05 223161 001 | 50 | 05 345019 001 | 370 | 05 380110 001 | 381 |
| 05 135973 001 | 84 | 05 259135 001 | 373 | 05 345026 001 | 364 | 05 380124 001 | 384 |
| 05 136000 001 | 426 | 05 300004 001 | 83 | 05 345028 001 | 364 | 05 380125 001 | 384 |
| 05 136001 001 | 426 | 05 300025 001 | 374 | 05 345032 001 | 364 | 05 380126 001 | 384 |
| 05 136002 001 | 426 | 05 300037 001 | 374 | 05 345035 001 | 364 | 05 380127 001 | 384 |
| 05 136011 001 | 465 | 05 302400 001 | 370 | 05 345047 001 | 360 | 05 380128 001 | 384 |
| 05 136220 001 | 361 | 05 302402 001 | 370 | 05 345056 001 | 364 | 05 380129 001 | 384 |
| 05 136400 001 | 196, 213 | 05 302403 001 | 370 | 05 345280 001 | 100 | 05 380130 001 | 384 |
| 05 137810 001 | 60 | 05 308428 001 | 360 | 05 345281 001 | 69 | 05 380131 001 | 384 |
| 05 138070 001 | 38 | 05 311517 001 | 426 | 05 345282 001 | 69 | 05 380155 001 | 319 |
| 05 138250 001 | 51 | 05 314753 001 | 364 | 05 345284 001 | 68 | 05 380156 001 | 319 |
| 05 138257 001 | 40 | 05 319835 001 | 360 | 05 345285 001 | 68 | 05 380157 001 | 319 |
| 05 138258 001 | 40 | 05 320430 001 | 369 | 05 345290 001 | 66 | 05 380158 001 | 319 |
| 05 138259 001 | 40 | 05 320540 001 | 50 | 05 345350 001 | 364 | 05 380160 001 | 328 |
| 05 138260 001 | 40 | 05 324901 001 | 393 | 05 345351 001 | 364 | 05 380161 001 | 328 |
| 05 138261 001 | 40 | 05 326310 001 | 370 | 05 345352 001 | 364 | 05 380200 001 | 330 |
| 05 138262 001 | 40 | 05 328448 001 | 360 | 05 346280 001 | 286 | 05 380201 001 | 330 |
| 05 138263 001 | 40 | 05 328463 001 | 85 | 05 346281 001 | 319 | 05 380202 001 | 330 |
| 05 138264 001 | 40 | 05 332600 001 | 360 | 05 346285 001 | 331 | 05 380380 001 | 336 |
| 05 138265 001 | 40 | 05 332606 001 | 370 | 05 346286 001 | 331 | 05 380381 001 | 336 |
| 05 138266 001 | 40 | 05 332607 001 | 364 | 05 346287 001 | 331 | 05 380382 001 | 336 |
| 05 138268 001 | 40 | 05 332609 001 | 364 | 05 346288 001 | 383 | 05 380383 001 | 336 |
| 05 138269 001 | 40 | 05 332610 001 | 364 | 05 346293 001 | 216 | 05 480171 001 | 322 |
| 05 138270 001 | 40 | 05 332612 001 | 370 | 05 347100 001 | 422 | 05 480172 001 | 322 |
| 05 140310 001 | 294 | 05 340245 001 | 389 | 05 347106 001 | 46 | 05 480173 001 | 322 |
| 05 160785 001 | 149 | 05 340260 001 | 442 | 05 347107 001 | 110 | 05 480221 001 | 341 |
| 05 160821 001 | 373 | 05 340322 001 | 453 | 05 347108 001 | 110 | 05 480222 001 | 341 |
| 05 160830 001 | 360 | 05 340330 001 | 34 | 05 347153 001 | 442 | 05 480223 001 | 341 |
| 05 160885 001 | 383 | 05 342920 001 | 353 | 05 347735 002 | 49 | 05 670446 001 | 303 |
| 05 160895 001 | 331 | 05 344280 001 | 370 | 05 347736 002 | 50 | 05 670447 001 | 303 |
| 05 160896 001 | 329 | 05 344281 001 | 370 | 05 347743 001 | 37 | 05 670448 001 | 303 |
| 05 160899 001 | 329 | 05 344282 001 | 370 | 05 347777 001 | 104 | | |

Article No. Index

1

| | |
|--------------------------|-----|
| 100 | 514 |
| 100 L | 515 |
| 100 S | 514 |
| 101 | 514 |
| 101 L | 515 |
| 102 | 514 |
| 102 L | 515 |
| 160 i SB | 94 |
| 160 i VDE | 94 |
| 160 i/162 i/167 i/9 | 104 |
| 160 i/165 i/7 Rack | 103 |
| 160 i/168 i/6 Rack | 104 |
| 160 i/6 Rack | 102 |
| 160 i/7 Rack | 102 |
| 160 iS | 94 |
| 160 iS/7 | 104 |
| 160 iSS | 94 |
| 160 iSS/7 | 104 |
| 162 i PH SB | 95 |
| 162 i PH VDE | 95 |
| 162 i PH/S SB | 97 |
| 162 i PH/S VDE | 97 |
| 162 iS | 96 |
| 162 iS PH/S | 98 |
| 162 iSS | 96 |
| 164 i VDE | 99 |
| 165 i PZ SB | 96 |
| 165 i PZ VDE | 96 |
| 165 i PZ/S SB | 98 |
| 165 i PZ/S VDE | 98 |
| 165 iS | 97 |
| 165 iS PZ/S | 98 |
| 165 iSS PZ/S | 98 |
| 167 i TORX® VDE | 99 |
| 167 i/6 | 103 |
| 168 i SB | 100 |
| 168 i VDE | 100 |
| 190 i VDE | 100 |
| 1013 Kraftform Micro | 70 |
| 1013 Kraftform Micro ESD | 83 |
| 1160 i VDE | 122 |
| 1160 i/1165 i/7 VDE | 123 |
| 1160 i/7 VDE | 122 |
| 1162 i PH VDE | 122 |
| 1165 i PZ VDE | 122 |

| | |
|---------------------|-----|
| 1267 A TORX PLUS® | 61 |
| 1267 A TORX® | 61 |
| 1267 B TORX PLUS® | 61 |
| 1267 B TORX® | 61 |
| 1334 | 54 |
| 1334/1355/6 | 56 |
| 1334/6 | 56 |
| 1335 | 54 |
| 1335/1350/1355/6 | 56 |
| 1350 PH | 54 |
| 1355 PZ | 54 |
| 1367 TORX® | 55 |
| 1367/6 TORX® | 56 |
| 1427 | 62 |
| 1428 | 62 |
| 1429 | 69 |
| 1430 ESD | 475 |
| 1440/1442 | 63 |
| 1441 | 63 |
| 1460 Micro ESD | 483 |
| 1550 PH Micro | 80 |
| 1550/6 ESD | 82 |
| 1555 PZ Micro | 80 |
| 1567 TORX PLUS® IPR | 81 |
| 1567 TORX® BO | 81 |
| 1567 TORX® HF Micro | 80 |
| 1567 TORX® Micro | 81 |
| 1569 ESD | 82 |
| 1572 ESD | 82 |
| 1578 A Micro | 80 |
| 1578 A/6 | 82 |

2

| | |
|---------------------|-----|
| 247 | 101 |
| 247 SB | 101 |
| 2035 Micro | 66 |
| 2035/6 A | 71 |
| 2035/6 B | 72 |
| 2050 PH Micro | 66 |
| 2050/6 | 72 |
| 2052 Micro | 68 |
| 2052/6 | 72 |
| 2054 Micro | 68 |
| 2055 PZ | 66 |
| 2067 IPR Micro | 68 |
| 2067 TORX® | 67 |
| 2067 TORX® BO Micro | 67 |

| | |
|-----------------|-----|
| 2067 TORX® HF | 66 |
| 2067/6 TORX® B0 | 73 |
| 2069 Micro | 69 |
| 2069/6 | 73 |
| 2072 | 68 |
| 2090 90 Nm | 511 |
| 2090/17 | 511 |

3

| | |
|---------------------------------|-----|
| 300 Hex | 486 |
| 300 Hex Pistole / Pistol | 486 |
| 300 IP | 486 |
| 300 IP Pistole / Pistol | 487 |
| 300 TX | 486 |
| 300 TX Pistole / Pistol | 487 |
| 334 | 34 |
| 334 SB | 35 |
| 334 SK | 34 |
| 334 SK/6 | 48 |
| 334/355 SK/6 | 48 |
| 334/355/6 Rack | 48 |
| 334/368/6 | 51 |
| 334/6 | 48 |
| 335 | 34 |
| 335/350/355/3 | 49 |
| 335/350/355/4 | 50 |
| 335/350/355/6 | 49 |
| 335/350/367/7 Lasertip | 50 |
| 336 Stubby | 44 |
| 350 PH | 36 |
| 350 PH SB | 36 |
| 350 SK PH | 36 |
| 352 | 38 |
| 354 Hex-Plus | 38 |
| 355 PZ | 37 |
| 355 SB | 37 |
| 355 SK PZ | 37 |
| 367 K TORX® | 40 |
| 367 SB | 39 |
| 367 TORX PLUS® | 40 |
| 367 TORX® | 39 |
| 367 TORX® B0 | 40 |
| 367 TORX® HF | 38 |
| 367/4 TORX HF extra lang / long | 50 |
| 367/6 TORX® | 51 |
| 367/6 TORX® B0 | 51 |
| 367/6 TORX® HF | 50 |
| 367/7 TORX® HF | 50 |

| | |
|---|-----|
| 368 | 41 |
| 368 SB | 41 |
| 371 TORQ-SET® Mplus | 40 |
| 375 TRI-WING® | 42 |
| 378 B | 35 |
| 391 | 42 |
| 392 | 287 |
| 395 | 42 |
| 395 H0 | 43 |
| 395 H0/7 SM | 51 |
| 3160 i VDE | 90 |
| 3160 i/7 Rack | 91 |
| 3162 i VDE | 90 |
| 3165 i PZ VDE | 90 |
| 3165 i/6 Rack | 91 |
| 3334 | 22 |
| 3334/3350/3355/6 | 25 |
| 3334/3355/6 | 24 |
| 3334/6 | 24 |
| 3335 | 22 |
| 3350 PH | 22 |
| 3355 PZ | 22 |
| 3367 TX | 23 |
| 3368 | 23 |
| 3800/1 TS | 376 |
| 3800/4 | 378 |
| 3816 R | 284 |
| 3840/1 TS | 380 |
| 3840/4 Hex-Plus | 382 |
| 3851/1 TS PH | 316 |
| 3851/4 | 326 |
| 3855/1 TS PZ | 338 |
| 3855/4 | 344 |
| 3867/1 TS SB SiS | 352 |
| 3867/1 TS TORX® | 352 |
| 3867/4 TORX® | 358 |
| 3867/4 TORX® B0 | 367 |
| 3868/1 TS | 388 |
| 3868/4 Square-Plus | 390 |
| 3869/4 | 401 |
| 3888/4/1 K | 414 |
| 3888/4/1 K SB SiS | 414 |
| 3950 PKL | 246 |
| 3950 PKL inch | 246 |
| 3950 SPKL Multicolour | 246 |
| 3950/9 Hex-Plus Imperial Stainless 1 | 239 |
| 3950/9 Hex-Plus Multicolour Stainless 1 | 238 |
| 3950/9 Hex-Plus Stainless 1 | 238 |
| 3950/9 Hex-Plus Stainless 1 SB | 238 |
| 3950/9 Hex-Plus Stainless 1 SB | 238 |

Article No. Index

4

| | |
|-----------|----|
| 454 | 76 |
| 454 inch | 76 |
| 467 TORX® | 76 |
| 489 R | 77 |
| 495 | 77 |

6

| | |
|----|-----|
| 68 | 294 |
|----|-----|

7

| | |
|-------------------------------|-----|
| 700 A HTS | 397 |
| 700 B HTS | 397 |
| 700 C HTS | 397 |
| 712 | 293 |
| 780 A | 428 |
| 780 B | 428 |
| 780 C | 428 |
| 784 A/1 | 428 |
| 784 B | 428 |
| 784 C | 428 |
| 797 A/4/1 B | 418 |
| 797 B/4/1 B | 418 |
| 7400 | 472 |
| 7400 ESD | 473 |
| 7400 ESD Halfmoon | 475 |
| 7400 ESD inch | 474 |
| 7400 ESD vor Halfmoon | 483 |
| 7400 inch | 474 |
| 7400 Pistole / Pistol | 472 |
| 7400 Pistole / Pistol inch | 474 |
| 7400 Pistole / Pistol pre-set | 480 |
| 7400 Pistole pre-set inch | 482 |
| 7400 VDE | 114 |
| 7400 pre-set | 480 |
| 7400 pre-set ESD | 481 |
| 7400 pre-set inch | 482 |
| 7440/41 | 476 |
| 7440/41/42 | 476 |

| | |
|------------|-----|
| 7443/12 | 477 |
| 7443/61/9 | 476 |
| 7445/46/47 | 476 |
| 7770 | 502 |
| 7771 | 503 |
| 7772 A | 504 |
| 7772 B | 504 |
| 7772 C | 504 |
| 7773 A | 504 |
| 7773 B | 505 |
| 7773 C | 505 |
| 7774/1 | 505 |
| 7774/2 | 505 |
| 7774/3 | 506 |
| 7775 | 506 |
| 7776 | 506 |
| 7779/1 | 507 |
| 7779/2 | 507 |
| 7780 | 502 |
| 7781 | 503 |
| 7782 C | 504 |
| 7782 E | 504 |
| 7783 C | 505 |
| 7783 E | 505 |
| 7786 | 506 |
| 7790/1 | 507 |
| 7790/2 | 507 |

8

| | |
|----------------|-----|
| 80 | 292 |
| 80 RA | 289 |
| 81 | 293 |
| 82 | 293 |
| 83 | 294 |
| 84 | 294 |
| 85 | 294 |
| 86 | 294 |
| 87 | 294 |
| 88/1 | 292 |
| 800/1 BDC | 376 |
| 800/1 BTZ | 376 |
| 800/1 HTN | 397 |
| 800/1 TZ | 376 |
| 800/1 Z | 377 |
| 800/1 Z Set D | 377 |
| 800/1 Z Set SB | 377 |

| | | | |
|-------------------------------|-----|-----------------|-----|
| 800/2 Z | 379 | 849/855/867/18 | 465 |
| 800/4 Z | 378 | 851/1 A PH | 318 |
| 800/9 C | 379 | 851/1 ADC PH | 318 |
| 807/4 Z | 379 | 851/1 AH | 319 |
| 810/1 ESD | 85 | 851/1 BDC PH | 317 |
| 810/1 Vario | 287 | 851/1 BDC SB | 317 |
| 811/1 ESD | 85 | 851/1 BTH PH | 318 |
| 811/1 Vario | 287 | 851/1 BTZ PH | 318 |
| 812/1 Vario | 287 | 851/1 IMP DC | 316 |
| 813 | 287 | 851/1 IMP DC SB | 316 |
| 813 R | 284 | 851/1 J | 325 |
| 813 R ESD | 84 | 851/1 RDC PH | 319 |
| 816 R | 284 | 851/1 RH | 319 |
| 816 R ESD | 83 | 851/1 RZ PH | 321 |
| 816 RA | 288 | 851/1 RZ SB | 321 |
| 817 R | 285 | 851/1 TH PH | 322 |
| 817 R SB SiS | 285 | 851/1 TiN PH | 322 |
| 817 VDE | 114 | 851/1 TiN SB | 322 |
| 819/1 Vario | 286 | 851/1 TZ PH | 323 |
| 819/1/6 | 286 | 851/1 TZ SB | 323 |
| 819/1/6 PH | 286 | 851/1 Z DIY 100 | 324 |
| 820/1/6 | 286 | 851/1 Z DIY | 324 |
| 830 | 292 | 851/1 Z PH | 324 |
| 840/1 BTZ Hex-Plus | 380 | 851/1 Z SB | 324 |
| 840/1 IMP DC | 380 | 851/11 PH | 333 |
| 840/1 IMP DC Impaktor Bits SB | 380 | 851/12 PH | 333 |
| 840/1 Z Hex-Plus | 381 | 851/15 PH | 334 |
| 840/1 Z Hex-Plus BO | 387 | 851/16 PH | 334 |
| 840/1 Z Set SB SiS | 381 | 851/2 Z PH | 332 |
| 840/2 Z | 385 | 851/21 J | 335 |
| 840/4 IMP DC | 382 | 851/22 | 336 |
| 840/4 IMP DC SB | 382 | 851/23 PH | 332 |
| 840/4 Z Hex-Plus | 383 | 851/25 H | 336 |
| 840/4 Z Hex-Plus BO | 387 | 851/4 A PH | 328 |
| 840/9 C | 386 | 851/4 ADC PH | 328 |
| 842/1 Z | 381 | 851/4 BDC PH | 326 |
| 842/4 | 384 | 851/4 BTH PH | 327 |
| 843 | 461 | 851/4 BTZ PH | 327 |
| 844 | 461 | 851/4 IMP DC | 326 |
| 844/7 | 461 | 851/4 IMP DC SB | 326 |
| 845 | 461 | 851/4 J | 330 |
| 845/8 | 462 | 851/4 PH/S | 350 |
| 846 HSS | 462 | 851/4 R PH | 329 |
| 846/8 | 462 | 851/4 RH | 328 |
| 847 HSS | 462 | 851/4 TH PH | 329 |
| 847/7 HSS | 463 | 851/4 TZ PH | 330 |
| 848 HSS | 463 | 851/4 TZ SB | 330 |
| 848/851/867/19 | 463 | 851/4 Z PH | 330 |
| 849 HSS | 463 | 851/4 Z SB | 330 |

Article No. Index

8

| | | | |
|-------------------|-----|-----------------------|-----|
| 851/9 C | 335 | 867/1 IP TORX PLUS® | 368 |
| 853/1 TZ ACR PH | 323 | 867/1 IPR | 372 |
| 853/4 ACR | 331 | 867/1 TORX® | 356 |
| 853/4 Harpoon ACR | 331 | 867/1 TORX® BDC | 353 |
| 855/1 BDC PZ | 339 | 867/1 TORX® BTZ | 354 |
| 855/1 BDC SB | 339 | 867/1 TZ TORX® | 355 |
| 855/1 BTH PZ | 340 | 867/1 Z TORX® BO | 366 |
| 855/1 BTZ PZ | 340 | 867/1 Z TORX® HF | 354 |
| 855/1 IMP DC | 338 | 867/1 Z TORX® W | 357 |
| 855/1 IMP DC SB | 338 | 867/1 ZA TORX® | 357 |
| 855/1 RZ PZ | 340 | 867/11 TORX® | 362 |
| 855/1 TH PZ | 341 | 867/12 TORX® | 362 |
| 855/1 TiN PZ | 341 | 867/15 TORX® | 363 |
| 855/1 TiN SB | 341 | 867/16 TORX® | 363 |
| 855/1 TZ PZ | 342 | 867/2 Z TORX® | 361 |
| 855/1 Z DIY 100 | 343 | 867/21 IPR TORX® PLUS | 374 |
| 855/1 Z DIY | 343 | 867/21 TORX PLUS® | 370 |
| 855/1 Z PZ | 342 | 867/21 TORX® | 364 |
| 855/1 Z SB | 342 | 867/22 TORX PLUS® | 370 |
| 855/11 PZ | 348 | 867/22 TORX® | 365 |
| 855/12 PZ | 349 | 867/4 H TORX® | 359 |
| 855/15 PZ | 349 | 867/4 IMP DC | 358 |
| 855/2 Z PZ | 348 | 867/4 IMP DC SB | 358 |
| 855/4 BDC PZ | 346 | 867/4 IP TORX PLUS® | 369 |
| 855/4 BTH PZ | 346 | 867/4 IPR | 373 |
| 855/4 BTZ PZ | 346 | 867/4 KK | 358 |
| 855/4 IMP DC | 344 | 867/4 TORX® HF | 359 |
| 855/4 IMP DC SB | 344 | 867/4 Z TORX® | 360 |
| 855/4 PZ/S | 351 | 867/4 Z TORX® BO | 367 |
| 855/4 TH PZ | 347 | 867/9 C TORX PLUS® | 370 |
| 855/4 TZ PZ | 347 | 867/9 C TORX® | 364 |
| 855/4 TZ SB | 347 | 867/9 IPR TORX® PLUS | 373 |
| 855/4 Z PZ | 347 | 868/1 BTZ Square-Plus | 388 |
| 855/4 Z SB | 347 | 868/1 IMP DC | 388 |
| 856/1 TZ ACR PZ | 342 | 868/1 IMP DC SB | 388 |
| 857/1 Z | 400 | 868/1 V | 389 |
| 857/4 Z | 400 | 868/1 Z | 389 |
| 860/1 XZN | 396 | 868/4 BTZ Square-Plus | 390 |
| 860/4 XZN | 396 | 868/4 IMP DC | 390 |
| 864/1 BTZ | 375 | 868/4 IMP DC SB | 390 |
| 864/1 Z | 375 | 868/4 Square-Plus | 391 |
| 867/1 BDC SB | 353 | 868/4 V | 391 |
| 867/1 IMP DC | 352 | 869/4 | 401 |
| 867/1 IMP DC SB | 352 | 869/4 M | 402 |
| | | 869/4 M SB | 402 |
| | | 869/4 M Set A SB | 402 |
| | | 869/9 | 402 |
| | | 870/1 | 426 |
| | | 870/14 | 427 |

| | | | |
|-----------------------------|-----|---------------------------------|-----|
| 870/2 | 426 | 897/4 R SB | 414 |
| 870/4 | 427 | 898/21 | 420 |
| 870/4 A | 426 | 898/4 | 420 |
| 870/4/7 Set A SB | 427 | 898/9 | 420 |
| 870/7 | 427 | 899/14/1 | 423 |
| 8700 A FL | 165 | 899/14/1 SB | 423 |
| 871/1 DC TORQ-SET® Mplus | 392 | 899/3/1 | 422 |
| 871/1 TORQ-SET® Mplus 25 mm | 392 | 899/4/1 | 422 |
| 871/1 TORQ-SET® Mplus 32 mm | 392 | 899/4/1 S | 423 |
| 871/19 TORQ-SET® Mplus | 394 | 899/4/1 SB | 422 |
| 871/2 TORQ-SET® Mplus | 394 | 899/5/1 | 423 |
| 871/4 DC TORQ-SET® Mplus | 393 | 899/8/1 | 423 |
| 871/4 TORQ-SET® Mplus | 393 | 899/8/1 K | 423 |
| 871/6 TORQ-SET® Mplus | 394 | 8000 A | 150 |
| 871/7 TORQ-SET® Mplus | 394 | 8000 A SB | 150 |
| 872/21 | 398 | 8000 B | 174 |
| 872/9 | 398 | 8000 B SB | 174 |
| 875/1 TRI-WING® 25 mm | 395 | 8000 C | 192 |
| 875/1 TRI-WING® 32 mm | 395 | 8000 C SB | 192 |
| 875/4 TRI-WING® | 395 | 8000 E | 196 |
| 875/6 TRI-WING® | 395 | 8001 A SB | 222 |
| 879/4 | 403 | 8002 C Koloss All Inclusive Set | 212 |
| 887/4 RR | 417 | 8002 C Koloss | 212 |
| 887/4 RR SB | 417 | 8003 A | 153 |
| 888/4/1 K | 416 | 8003 B | 177 |
| 889/4 R | 416 | 8003 C | 199 |
| 889/4/1 | 416 | 8004 A | 155 |
| 889/4/1 K | 415 | 8004 B | 179 |
| 890/00/0 | 421 | 8004 C | 201 |
| 890/4/1 | 421 | 8005 | 222 |
| 890/6/1 | 421 | 8006 C | 196 |
| 890/7/1 | 421 | 8006 SC 1 | 194 |
| 890/7/2 | 421 | 8007 B VDE | 126 |
| 891/4/1 | 424 | 8100 SA 10 | 152 |
| 891/8/1 | 424 | 8100 SA 11 | 154 |
| 893/4/1 K | 422 | 8100 SA 12 HF | 155 |
| 893/4/1 K SB | 422 | 8100 SA 2 | 148 |
| 894/14/1 | 419 | 8100 SA 4 | 148 |
| 894/4/1 | 419 | 8100 SA 6 | 144 |
| 894/4/1 K | 419 | 8100 SA 7 | 152 |
| 895/14/1 | 420 | 8100 SA 8 | 154 |
| 895/4/1 | 420 | 8100 SA 9 | 145 |
| 895/4/1 K | 419 | 8100 SA All-In | 144 |
| 895/4/1 K SB | 419 | 8100 SA/SC 2 | 149 |
| 896/4/1 SB | 425 | 8100 SB 10 | 176 |
| 897/4 Impaktor Impaktor | 410 | 8100 SB 11 | 178 |
| 897/4 Impaktor Impaktor R | 410 | 8100 SB 2 | 173 |
| 897/4 Impaktor R SB | 410 | 8100 SB 4 | 174 |
| 897/4 R | 414 | 8100 SB 6 | 172 |

Article No. Index

8

| | |
|----------------------|-----|
| 8100 SB 7 | 176 |
| 8100 SB 8 | 178 |
| 8100 SB 9 | 172 |
| 8100 SB HF 1 | 179 |
| 8100 SB VDE 1 | 129 |
| 8100 SC 10 | 198 |
| 8100 SC 11 | 200 |
| 8100 SC 2 | 191 |
| 8100 SC 4 | 192 |
| 8100 SC 6 | 190 |
| 8100 SC 7 | 198 |
| 8100 SC 8 | 200 |
| 8100 SC 9 | 190 |
| 8740 A | 162 |
| 8740 A HF | 162 |
| 8740 A HF 1 | 163 |
| 8740 B HF | 183 |
| 8740 B HF 1 | 184 |
| 8740 B HF Imperial 1 | 184 |
| 8740 C HF | 206 |
| 8740 C HF 1 | 205 |
| 8740 C HF 2 | 206 |
| 8751 A | 164 |
| 8755 A | 164 |
| 8767 A HF | 160 |
| 8767 A HF 1 | 161 |
| 8767 B HF | 182 |
| 8767 B HF 1 | 182 |
| 8767 C HF | 204 |
| 8767 C HF 1 | 204 |
| 8767 C HF 2 | 204 |
| 8767 C HF 3 | 205 |
| 8780 C | 212 |
| 8781 C | 213 |
| 8782 C | 213 |
| 8784 A1 | 169 |
| 8784 B1 | 186 |
| 8784 C2 | 209 |
| 8789 A | 166 |
| 8789 B | 187 |
| 8789 C | 209 |
| 8790 B VDE | 126 |
| 8790 C HF 1 | 203 |
| 8790 FA | 223 |

| | |
|-------------|-----|
| 8790 HMA | 156 |
| 8790 HMA HF | 156 |
| 8790 HMB | 180 |
| 8790 HMB HF | 180 |
| 8790 HMC | 202 |
| 8790 HMC HF | 202 |
| 8794 A | 169 |
| 8794 B | 187 |
| 8794 C | 209 |
| 8794 LA | 166 |
| 8794 LB | 186 |
| 8794 LB VDE | 128 |
| 8794 LC | 208 |
| 8794 SA | 167 |
| 8794 SB | 186 |
| 8794 SB VDE | 128 |
| 8794 SC | 208 |
| 8795 A | 169 |
| 8795 B | 187 |
| 8795 C | 209 |
| 8796 LA | 166 |
| 8796 LB | 186 |
| 8796 LC | 208 |
| 8796 SA | 166 |
| 8796 SB | 186 |
| 8796 SC | 208 |
| 8797 C | 196 |

9

| | |
|------------|-----|
| 91 | 292 |
| 95 | 292 |
| 917 SPH | 28 |
| 917 SPH SB | 28 |
| 917 SPHS | 28 |
| 918 SPZ | 29 |
| 918 SPZ SB | 29 |
| 919 PH | 257 |
| 919 PZ | 257 |
| 920 A | 257 |
| 930 A | 60 |
| 930/935/6 | 60 |
| 930/955/6 | 60 |
| 932 A | 28 |
| 932 A SB | 28 |
| 932 AS | 28 |
| 932 S/6 | 30 |

| | |
|---------------------------------------|-----|
| 932/6 | 30 |
| 932/918/6 | 31 |
| 935 SPH | 60 |
| 950 | 249 |
| 950 BM | 249 |
| 950 L | 248 |
| 950 PKL | 247 |
| 950 PKL BM | 247 |
| 950 PKL inch | 248 |
| 950 PKLS | 248 |
| 950 PKS | 248 |
| 950 SPKL HF Multicolour | 246 |
| 950 SPKL inch | 247 |
| 950 SPKL Multicolour | 247 |
| 950/13 Hex-Plus Imperial 1 | 245 |
| 950/7 Hex-Plus 1 | 244 |
| 950/7 Hex-Plus Magnet 1 | 244 |
| 950/7 Hex-Plus Multicolour Magnet 1 | 241 |
| 950/9 Hex-Plus 3 | 242 |
| 950/9 Hex-Plus 1 | 242 |
| 950/9 Hex-Plus 1 SB | 242 |
| 950/9 Hex-Plus 2 | 242 |
| 950/9 Hex-Plus 4 | 243 |
| 950/9 Hex-Plus 5 | 243 |
| 950/9 Hex-Plus 6 | 244 |
| 950/9 Hex-Plus 6 SB | 244 |
| 950/9 Hex-Plus 7 | 244 |
| 950/9 Hex-Plus Imperial 1 | 245 |
| 950/9 Hex-Plus Imperial 1 SB | 245 |
| 950/9 Hex-Plus Multicolour 1 | 240 |
| 950/9 Hex-Plus Multicolour 1 SB | 240 |
| 950/9 Hex-Plus Multicolour HF 1 | 240 |
| 950/9 Hex-Plus Multicolour Imperial 1 | 241 |
| 955 SPZ | 60 |
| 967 L TORX® HF | 256 |
| 967 PKL TORX® | 256 |
| 967 PKXL TORX® | 256 |
| 967 SL TORX® HF | 254 |
| 967 SPKL TORX® BO Multicolour | 254 |
| 967 SPKXL TORX® Multicolour | 253 |
| 967 SXL HF TORX® Multicolour | 253 |
| 967 SXL TORX® Multicolour | 254 |
| 967 TORX® | 256 |
| 967 XL HF TORX® | 254 |
| 967 XL TORX® | 256 |
| 967/9 TX 1 | 252 |
| 967/9 TX BO Multicolour 1 | 212 |
| 967/9 TX HF 1 | 250 |
| 967/9 TX Multicolour HF 1 | 250 |
| 967/9 TX XL Multicolour HF 1 | 250 |

| | |
|---------------------------|-----|
| 967/9 TX XL 1 | 252 |
| 967/9 TX XL HF 1 | 250 |
| 967/9 TX XL Multicolour 1 | 251 |
| 977 TORX® | 29 |
| 977/6 TORX® | 31 |

ABC

| | |
|---|-----|
| BC 10 Drywall 1 | 465 |
| Belt A 1 | 157 |
| Belt A 2 | 162 |
| Belt A 3 | 161 |
| Belt A 4 | 159 |
| Belt A Imperial 1 | 160 |
| Belt A, 8-teilig / 8 location, unbestückt / unloaded | 163 |
| Belt A, 9-teilig / 9 location, unbestückt / unloaded | 164 |
| Belt B 1 | 181 |
| Belt B 2 | 184 |
| Belt B 3 | 182 |
| Belt B 4 | 181 |
| Belt B Imperial 1 | 184 |
| Belt B, 8-teilig / 8 location, unbestückt / unloaded | 185 |
| Belt B, 9-teilig / 9 location, unbestückt / unloaded | 185 |
| Big Pack 900 | 30 |
| Bit-Box 15 Impaktor PH | 316 |
| Bit-Box 15 Impaktor PZ | 338 |
| Bit-Box 15 Impaktor TX | 352 |
| Bit-Box 20 BTH PZ | 340 |
| Bit-Box 20 BTZ PH | 318 |
| Bit-Box 20 BTZ PZ | 340 |
| Bit-Box 20 BTZ TX | 354 |
| Bit-Box 20 PH | 324 |
| Bit-Box 20 PZ | 342 |
| Bit-Box 20 RZ PH | 321 |
| Bit-Box 20 TX | 356 |
| Bit-Box 20 V Robertson | 389 |
| Bit-Check 10 BiTorsion 1 | 441 |
| Bit-Check 10 BiTorsion 2 | 441 |
| Bit-Check 10 BiTorsion 3 SB | 442 |
| Bit-Check 10 Diamond 1 | 444 |
| Bit-Check 10 Impaktor 1 | 434 |
| Bit-Check 10 Impaktor 1 SB | 434 |
| Bit-Check 10 Impaktor 2 | 434 |
| Bit-Check 10 Impaktor 3 | 434 |

Article No. Index

ABC

| | | | |
|--------------------------------------|-----|--------------------------------|-----|
| Bit-Check 10 Impaktor 4 | 435 | Bit-Check 6 PH Impaktor 1 | 436 |
| Bit-Check 10 PZ BiTorsion 1 | 442 | Bit-Check 6 PZ Diamond 1 | 447 |
| Bit-Check 10 PZ BiTorsion 2 | 442 | Bit-Check 6 PZ Impaktor 1 | 436 |
| Bit-Check 10 PZ Impaktor 1 | 435 | Bit-Check 6 PZ Universal 1 | 456 |
| Bit-Check 10 PZ Universal 1 | 451 | Bit-Check 6 Stainless 1 SB | 439 |
| Bit-Check 10 PZ Universal 2 | 451 | Bit-Check 6 TX HF 1 | 457 |
| Bit-Check 10 Stainless 1 | 438 | Bit-Check 6 TX Impaktor 1 | 436 |
| Bit-Check 10 Stainless 1 SB | 438 | Bit-Check 6 TX Universal 1 | 456 |
| Bit-Check 10 TX Impaktor 1 | 435 | Bit-Check 6 TX Universal 1 SB | 456 |
| Bit-Check 10 TX Universal 1 | 452 | Bit-Check 6 Universal 1 | 455 |
| Bit-Check 10 TX Universal 2 | 452 | Bit-Check 6 Universal 1 SB | 455 |
| Bit-Check 10 Universal 1 | 450 | Bit-Check 6 Universal 2 | 456 |
| Bit-Check 10 Universal 2 | 450 | Bit-Check 6 Universal 3 | 456 |
| Bit-Check 10 Universal 3 | 450 | Bit-Check 6 V Universal 1 | 457 |
| Bit-Check 10 Universal 3 SB | 450 | Bit-Check 7 Diamond 1 | 445 |
| Bit-Check 10 Universal 4 | 450 | Bit-Check 7 Diamond 1 SB | 445 |
| Bit-Check 10 Universal 5 SB | 451 | Bit-Check 7 Hex-Plus 1 | 454 |
| Bit-Check 10 Zyklus Mini 1 | 220 | Bit-Check 7 PH BiTorsion 1 | 443 |
| Bit-Check 10 Zyklus Mini BiTorsion 1 | 220 | Bit-Check 7 PH Diamond 1 | 446 |
| Bit-Check 12 BiTorsion 1 | 440 | Bit-Check 7 PZ BiTorsion 1 | 442 |
| Bit-Check 12 Diamond 1 | 444 | Bit-Check 7 PZ Diamond 1 | 446 |
| Bit-Check 12 Metal 1 | 460 | Bit-Check 7 PZ Diamond 1 SB | 446 |
| Bit-Check 12 Stainless 1 | 438 | Bit-Check 7 PZ Universal 1 | 453 |
| Bit-Check 12 Universal 1 | 449 | Bit-Check 7 PZ Universal 1 SB | 453 |
| Bit-Check 12 Universal 2 | 449 | Bit-Check 7 PZ Universal 2 | 453 |
| Bit-Check 12 Wood 1 | 458 | Bit-Check 7 TiN Universal 1 | 454 |
| Bit-Check 12 Wood 2 | 459 | Bit-Check 7 TiN Universal 1 SB | 454 |
| Bit-Check 12 Wood 3 | 459 | Bit-Check 7 TX BO Universal 1 | 454 |
| Bit-Check 12 Wood 4 | 459 | Bit-Check 7 TX Diamond 1 | 446 |
| Bit-Check 30 BiTorsion 1 | 440 | Bit-Check 7 TX Universal 1 | 454 |
| Bit-Check 30 Diamond 1 | 444 | Bit-Check 7 TX Universal 1 SB | 454 |
| Bit-Check 30 Impaktor 1 | 434 | Bit-Check 7 Universal 1 | 452 |
| Bit-Check 30 Metal 1 | 460 | Bit-Check 7 Universal 2 | 453 |
| Bit-Check 30 Stainless 1 | 438 | Bit-Check 7 Universal 3 | 453 |
| Bit-Check 30 TX Universal 1 | 449 | Bit-Check 7 Universal 4 | 453 |
| Bit-Check 30 Universal 1 | 448 | Bit-Safe 43 Universal 1 | 448 |
| Bit-Check 30 Wood 1 | 458 | Bit-Safe 61 BiTorsion 1 | 440 |
| Bit-Check 30 Wood 2 | 458 | Bit-Safe 61 Universal 1 | 448 |
| Bit-Check 30 Zyklus Mini 1 | 216 | Bit-Safe 61 Universal 2 | 448 |
| Bit-Check 30 Zyklus Mini 2 | 216 | Bit-Safe 61 Wood 1 | 458 |
| Bit-Check 6 Impaktor 1 | 436 | Click-Torque A 5 | 492 |
| Bit-Check 6 Impaktor 2 | 436 | Click-Torque A 6 | 492 |
| Bit-Check 6 PH BiTorsion 1 | 443 | Click-Torque B 1 | 494 |
| Bit-Check 6 PH Diamond 1 | 447 | Click-Torque B 2 | 494 |
| | | Click-Torque C 1 | 495 |
| | | Click-Torque C 2 | 495 |
| | | Click-Torque C 3 | 496 |
| | | Click-Torque C 4 | 496 |
| | | Click-Torque C 5 | 497 |

| | | | |
|---|-----|--|-----|
| Click-Torque E 1 | 497 | Kraftform Kompakt 64 i | 117 |
| Click-Torque X 1 | 498 | Kraftform Kompakt 65 i PZ | 115 |
| Click-Torque X 2 | 498 | Kraftform Kompakt 65 i PZ/S | 116 |
| Click-Torque X 3 | 499 | Kraftform Kompakt 65 iS PZ | 115 |
| Click-Torque X 4 | 499 | Kraftform Kompakt 65 iS PZ/S | 116 |
| Click-Torque X 5 | 500 | Kraftform Kompakt 67 i TORX® | 116 |
| Click-Torque X 6 | 500 | Kraftform Kompakt 67 iS TORX® | 117 |
| Joker | 228 | Kraftform Kompakt 68 i | 117 |
| Joker Double | 228 | Kraftform Kompakt 68 iS | 117 |
| Joker inch | 228 | Kraftform Kompakt 70 Allround | 276 |
| Joker Set 4 | 230 | Kraftform Kompakt 71 Security | 276 |
| Joker Set 6 | 229 | Kraftform Kompakt 96 VK 6,3 | 118 |
| Joker Set Switch | 231 | Kraftform Kompakt 97 VK 8,1 | 118 |
| Joker Switch | 230 | Kraftform Kompakt 98 DK | 118 |
| Joker Switch inch | 230 | Kraftform Kompakt 99 FL | 118 |
| Joker Set 4 inch SB | 230 | Kraftform Kompakt Pistol RA | 290 |
| Joker Set switch 4 inch | 231 | Kraftform Kompakt Pistol RA 4 | 290 |
| Joker Set 11 | 228 | Kraftform Kompakt VDE 15 Torque | |
| Joker Set 8 inch | 229 | 1,2-3,0 Nm extra slim 1 | 108 |
| Joker Set Switch 11 | 232 | Kraftform Kompakt VDE 16 extra slim 1 | 112 |
| Joker Set Switch 8 | 232 | Kraftform Kompakt VDE 16 Torque | |
| Kraftform Kompakt 10 | 262 | 1,2-3,0 Nm | 108 |
| Kraftform Kompakt 12 | 262 | Kraftform Kompakt VDE 16 Universal 1 | 112 |
| Kraftform Kompakt 20 | 264 | Kraftform Kompakt VDE 17 Universal 1 | 111 |
| Kraftform Kompakt 20 A | 264 | Kraftform Kompakt VDE 18 Imperial 1 | 110 |
| Kraftform Kompakt 22 | 264 | Kraftform Kompakt VDE 18 Universal 1 | 109 |
| Kraftform Kompakt 25 | 266 | Kraftform Kompakt VDE 18 Universal 2 | 110 |
| Kraftform Kompakt 26 | 266 | Kraftform Kompakt VDE 7 Imperial 1 | 113 |
| Kraftform Kompakt 27 RA 1 SB | 290 | Kraftform Kompakt VDE 7 Universal 1 | 113 |
| Kraftform Kompakt 27 RA 2 SB | 290 | Kraftform Kompakt VDE 7 Universal 2 | 113 |
| Kraftform Kompakt 40 | 268 | Kraftform Kompakt Zyklus Mini 2 | 217 |
| Kraftform Kompakt 41 | 268 | Klettstreifen / Hook and Loop | |
| Kraftform Kompakt 50 | 269 | Fastener Strips 1 | 303 |
| Kraftform Kompakt 60 | 272 | Klettstreifen Hook and Loop | |
| Kraftform Kompakt 60 ESD | 84 | Fastener Strips 2 | 303 |
| Kraftform Kompakt 60 i | 114 | Klettstreifen Hook and Loop | |
| Kraftform Kompakt 60 Imperial | 272 | Fastener Strips 3 | 303 |
| Kraftform Kompakt 60 iS | 114 | Kraftform 2go 100 | 105 |
| Kraftform Kompakt 60 KK | 272 | Kraftform 2go 300 | 46 |
| Kraftform Kompakt 60 RA | 288 | Kraftform Big Pack 100 VDE | 102 |
| Kraftform Kompakt 60 RA Imperial | 288 | Kraftform Big Pack 300 | 45 |
| Kraftform Kompakt 60 Stainless | 270 | Kraftform Kompakt 100 | 278 |
| Kraftform Kompakt 60 Stainless Imperial | 271 | Kraftform Kompakt 20 Tool Finder 1 | 264 |
| Kraftform Kompakt 60 Torque | 270 | Kraftform Kompakt 28 mit Tasche / | |
| Kraftform Kompakt 62 | 273 | with pouch | 267 |
| Kraftform Kompakt 62 i | 114 | Kraftform Kompakt 28 SB | 267 |
| Kraftform Kompakt 62 i PH/S | 116 | Kraftform Kompakt H1 Holz | 280 |
| Kraftform Kompakt 62 iS | 115 | Kraftform Kompakt M1 Metall | 281 |
| Kraftform Kompakt 62 iS PH/S | 116 | Kraftform Kompakt Micro 11 Electronics 1 | 71 |

Article No. Index

ABC

| | |
|--|-----|
| Kraftform Kompakt Micro 11 ESD 1 | 85 |
| Kraftform Kompakt Micro 11 Universal 1 | 71 |
| Kraftform Kompakt Micro 20 ESD 1 | 85 |
| Kraftform Kompakt Micro 21 ESD 1 | 84 |
| Kraftform Kompakt SH 1 | 282 |
| Kraftform Kompakt Vario RA | 289 |
| Kraftform Kompakt W1 Wartung | 280 |
| Kraftform Kompakt Zyklus | 150 |
| Kraftform Kompakt Zyklus MS1 | |
| Metal/Speed 1/4 | 146 |
| Kraftform Micro 12 Electronics 1 | 70 |
| Kraftform Micro 12 Universal 1 | 70 |
| Kraftform XXL | 45 |
| Kraftform XXL 2 | 46 |
| Kraftform XXL 3 | 46 |
| Mutterentnahme-Werkzeug / Nut Extractor | 159 |
| Rack | 63 |
| Rack Micro | 62 |
| Stubby PH | 44 |
| Stubby PZ | 44 |
| Tool-Check 1 SB | 219 |
| Tool-Check Automotive 1 | 220 |
| Tool-Check PLUS | 218 |
| Tool-Check PLUS Imperial | 218 |
| Wera 2go 1 | 300 |
| Wera 2go 2 | 300 |
| Wera 2go 3 | 300 |
| Wera 2go 4 | 300 |
| Wera 2go 5 | 301 |
| Wera 2go 6 | 301 |
| Wera Star | 62 |
| Zyklus Hybrid Set | 194 |

Alphabetical Index

All products from A to Z

A

| | |
|---|--------------------|
| Adaptors | 292, 426, 427, 428 |
| Assembly set for tyre pressure control systems | 476, 477 |
| ASSY® | |
| Bits | 375 |
| Awl | 62 |

B

| | |
|--|---|
| Ballhead | |
| Bits | 272, 358, 381, 384 |
| Screwdrivers | 38, 40 |
| Belts | 157, 159, 160, 161, 162, 163, 164, 181, 182, 184, 185 |
| Bit-Box | 316, 318, 321, 324, 338, 340, 342, 352, 354, 356, 389 |
| Bit-Checks | 216, 220, 434, 435, 436, 438, 439, 440, 441, 442, 443, 444, 445, 446, 447, 448, 449, 450, 451, 452, 453, 454, 455, 456, 457, 458, 459, 460, 465 |
| Bit-Safes | 440, 448, 458 |
| Bitholding Kraffform Micro Screwdrivers | 70 |
| Bitholding Screwdrivers | 77, 83, 84, 85, 284, 285, 286, 287 |
| BiTorsion | |
| Bits | 317, 318, 326, 327, 339, 340, 346, 353, 354, 375, 376, 380, 388, 390, 440, 441, 442, 443 |
| Bit Holder | 418 |
| Bit Sets | 440, 441, 442, 443 |
| Bits | |
| ACR (Anti Cam-Out Ribs) | 323, 331, 342 |
| ASSY® | 375 |
| BiTorsion | 317, 318, 326, 327, 339, 340, 346, 353, 354, 375, 376, 380, 388, 390, 440, 441, 442, 443 |
| Countersink Bits | 461, 462 |
| Diamond-coated | 317, 318, 319, 326, 328, 339, 346, 353, 376, 392, 393, 444, 445, 446, 447 |
| Double-ended Bits | 332 |
| Drill bits | 462, 463, 465 |
| Halfmoon | 335, 364, 370, 373, 379, 386 |
| Hex-Plus | 380, 381, 382, 383, 384, 385, 386, 387 |
| Hexagon socket screws | 380, 381, 382, 383, 384, 385, 386 |
| Hexagon socket screws BO | 387 |

Alphabetical Index

All products from A to Z

B

Bits

| | |
|------------------------|---|
| Hi-TORQUE | 397 |
| HIOS | 335, 336, 364, 365, 370, 398 |
| Impaktor | 316, 326, 338, 344, 352, 358, 380, 382, 387, 388, 390, 434, 435, 436 |
| Microstix® | 398 |
| Multipoint | 396 |
| Phillips PH | 316, 317, 318, 319, 321, 322, 323, 324, 325, 326, 327, 328, 329, 330, 331, 332, 333, 334, 335, 336, 347 |
| pias | 375 |
| PlusMinus PH-S | 350 |
| PlusMinus PZ-S | 351 |
| Pozidriv PZ | 321, 338, 339, 340, 341, 342, 343, 344, 346, 347, 348, 349 |
| Reduced shank diameter | 319, 321, 340 |
| Single Tap Bits | 461 |
| Slotted | 376, 377, 378, 379 |
| Snake Eye | 400 |
| Spanner | 400 |
| Square socket screws | 388, 389, 390, 391 |
| Stainless Steel | 316, 326, 338, 344, 352, 358, 367, 376, 378, 380, 382, 388, 390, 438, 439 |
| Stepped drill bits | 461 |
| TiN-coated | 322, 341, 454 |
| TORQ-SET® | 392, 393, 394 |
| TORX® | 352, 353, 354, 355, 356, 358, 359, 360, 361, 362, 363, 364, 365 |
| TORX® B0 | 366, 367 |
| TORX® Wedge | 357 |
| TORX® with Safety Pin | 357 |
| TORX PLUS® | 368, 369, 370 |
| TORX PLUS® IPR | 372, 373, 374 |
| TRI-WING® | 395 |

Bits with Holding Function

| | |
|-------|----------|
| TORX® | 354, 359 |
|-------|----------|

Bit Holder

| | |
|---------------------------|----------|
| Adjustable depth stop | 425 |
| BiTorsion | 418 |
| Combination HIOS&Halfmoon | 420 |
| Copper Beryllium Sleeve | 424 |
| Impaktor | 410, 414 |

Bit Holder

| | |
|----------------------------|--------------------|
| Quick Release Chuck | 419, 420 |
| Rapidaptor | 414, 415, 416, 417 |
| Rapidaptor Ring Magnet | 417 |
| Rapidaptor Stainless Steel | 414 |
| Retaining Ring | 421 |
| Stainless Steel Sleeve | 422, 423 |

Bit Sets

| | |
|------------|---|
| Bit-Checks | 216, 220, 434, 435, 436, 438, 439, 440, 441, 442, 443, 444, 445, 446, 447, 448, 449, 450, 451, 452, 453, 454, 455, 456, 457, 458, 459, 460, 465 |
| Bit-Safes | 440, 448, 458 |
| BiTorsion | 440, 441, 442, 443 |
| Diamond | 444, 445, 446, 447 |
| Impaktor | 434, 435, 436 |
| Metal | 460 |
| Stainless | 438, 439 |
| Universal | 448, 449, 450, 451, 452, 453, 454, 455, 456, 457 |
| Wood | 458, 459 |

Bit Sockets

| | |
|---|------------------------------|
| Hexagon socket | 162 |
| Hexagon socket screws with Holding Function | 162, 163, 183, 184, 205, 206 |
| Slotted | 165 |
| TORX [®] with Holding Function | 160, 161, 182, 204, 205 |

C

| | |
|------------------|--------------------|
| Chip lifter | 69 |
| Chiseldriver | 28, 29, 30, 31, 60 |
| Countersink Bits | 461, 462 |

D

| | |
|---------------------|---|
| Diamond-coated Bits | 317, 318, 319, 326, 328, 339, 346, 353, 376, 392, 393, 444, 445, 446, 447 |
| Double-ended Bits | 332 |
| Drill bits | 462, 463, 465 |

Alphabetical Index

All products from A to Z

E

| | |
|---------------------------------|--|
| Electronics Screwdrivers | 66, 67, 68, 69, 70, 71, 72, 73, 80, 81, 82, 84 |
| ESD Tools | 82, 83, 84, 85, 473, 474, 475, 481, 483 |

F

| | |
|--------------------|----|
| Flagdrivers | |
| TORX® | 61 |
| TORX PLUS® | 61 |

G

| | |
|----------------------|-----|
| Guide Sleeves | 379 |
|----------------------|-----|

H

| | |
|-----------------------------------|---|
| Halfmoon | |
| Bits | 335, 364, 370, 373, 379, 386 |
| Hex-Plus | |
| Bit Sockets | 162 |
| Bit Sockets with Holding Function | 162, 163, 183, 184, 205, 206 |
| Bits | 380, 381, 382, 383, 384, 385, 386, 387 |
| L-Keys | 238, 239, 240, 241, 242, 243, 244, 245, 246, 247, 248, 249, 256 |
| Screwdrivers | 38 |
| Hexagon socket screws | |
| Bits | 380, 381, 382, 383, 384, 385, 386 |
| Bit Sockets | 162 |
| Bit Sockets with Holding Function | 162, 163, 183, 184, 205, 206 |
| L-Keys | 240, 241, 242, 243, 244, 245, 246, 247, 248, 249, 256 |
| L-Keys extra short arm | 243, 248 |
| Screwdrivers | 38 |
| Hexagon socket screws B0 | |
| Bits | 387 |
| Hi-TORQUE | |
| Bits | 397 |

HIOS

Bits

335, 336, 364, 365, 370, 398

Hose Clamp Screwdrivers

42

I

Impact Drivers

511

Impaktor

Bits

316, 326, 338, 344, 352, 358, 380, 382, 387, 388, 390,
434, 435, 436

Bit Holder

410, 414

Bit Sets

434, 435, 436

Insulated Tools

94, 95, 96, 97, 98, 99, 100, 102, 103, 104, 108, 109, 110,
111, 112, 113, 114, 122, 123, 126, 128, 129

with reduced blade diameter

94, 96, 97, 98, 104, 111, 112, 114, 115, 116, 117

Internal thread insertion tools

403

J

Joker

228, 229, 230, 231, 232

K

Koloss

212, 213

Kraftform Kompakt 10

262

Kraftform Kompakt 20

264, 266, 267, 290

Kraftform Kompakt 40

268

Kraftform Kompakt 50

269

Kraftform Kompakt 60

270, 271, 272, 273

Kraftform Kompakt 70

276

Kraftform Kompakt 100

278

Kraftform Kompakt Ratchet

288, 289, 290

Kraftform Kompakt user-specific sets

280, 281, 282

Kraftform Kompakt Vario

289, 292, 293, 294

Kraftform Kompakt VDE (insulated)

108, 109, 110, 111, 112, 113, 114, 115, 116, 117, 118

Kraftform Micro

66, 67, 68, 69, 70, 71, 72, 73, 80, 81, 82, 84

Alphabetical Index

All products from A to Z

L

L-Keys

| | |
|-----------------------------|---|
| extra short arm | 243, 248 |
| Hex-Plus | 238, 239, 240, 241, 242, 243, 244, 245, 246, 247, 248, 249, 256 |
| Hexagon socket screws | 240, 241, 242, 243, 244, 245, 246, 247, 248, 249, 256 |
| TORX® | 212, 250, 251, 252, 253, 254, 256 |
| TORX® B0 | 212, 254 |
| with Holding Function TORX® | 240, 246, 250, 254, 256 |

M

Magnetizer

| | |
|--------------|----|
| Demagnetizer | 62 |
|--------------|----|

Microstix®

| | |
|--------------|--------|
| Bits | 398 |
| Screwdrivers | 68, 82 |

Multipoint

| | |
|------|-----|
| Bits | 396 |
|------|-----|

N

Nutsetters

| |
|----------------------|
| 42, 43, 51, 401, 402 |
|----------------------|

O

Offset Screwdrivers

| |
|-----|
| 257 |
|-----|

P

Phillips PH

| | |
|--------------|---|
| Bits | 316, 317, 318, 319, 321, 322, 323, 324, 325, 326, 327, 328, 329, 330, 331, 332, 333, 334, 335, 336, 347 |
| Bit Sockets | 164 |
| Screwdrivers | 22, 36, 54, 90 |

pias

| | |
|------|-----|
| Bits | 375 |
|------|-----|

PlusMinus PH-S

| | |
|--------------|-------------|
| Bits | 350 |
| Screwdrivers | 97, 98, 116 |

PlusMinus PZ-S

| | |
|--------------|---------|
| Bits | 351 |
| Screwdrivers | 98, 116 |

Pozidriv PZ

| | |
|--------------|--|
| Bits | 321, 338, 339, 340, 341, 342, 343, 344, 346, 347, 348, 349 |
| Bit Sockets | 164 |
| Screwdrivers | 22, 37, 54, 90 |

R

Rack

| | |
|-----------------|----|
| Kraftform | 63 |
| Kraftform Micro | 62 |

Rapidaptor

| | |
|------------------------|--------------------|
| Bit Holder | 414, 415, 416, 417 |
| Bit Holder Ring Magnet | 417 |
| Stainless Steel | 414 |

Ratchets

| | |
|-------------------------|---|
| Koloss | 212 |
| Koloss Accessories | 213 |
| Zyklop Accessories | 156, 166, 167, 169, 180, 186, 187, 196, 202, 203, 204, 205, 206, 208, 209 |
| Zyklop Hybrid | 194, 196 |
| Zyklop Metal | 144, 146, 152, 153, 154, 155, 176, 177, 178, 179, 198, 199, 200, 201 |
| Zyklop Mini | 216, 217, 218, 219, 220, 222 |
| Zyklop Mini Accessories | 223 |
| Zyklop Speed | 126, 144, 145, 146, 148, 149, 150, 155, 172, 173, 174, 190, 191, 192 |
| Zyklop VDE | 126, 128, 129 |

Alphabetical Index

All products from A to Z

R

Ratchet Wrenches 228, 229, 230, 231, 232

Reamer 62

S

Screwdrivers

Hex-Plus 38

Hexagon socket screws 38

Phillips PH 22, 36, 54, 90

PlusMinus PH-S 97, 98, 116

Pozidriv PZ 22, 37, 54, 90

Slotted 22, 34, 35, 54, 60, 90

Square socket screws 23, 41

TORQ-SET® 40

TORX® 23, 39, 40, 51, 55

TORX® BO 40, 51

TORX PLUS® 40

TORX PLUS® IPR 68, 81

TRI-WING® 42

Wood 60

Screwdrivers PlusMinus PH-S 97, 98

Screwdrivers PlusMinus PZ-S 98, 116

Screwdrivers with Holding Function

TORX® 38, 50, 66, 80

Screwdriver Sets 45, 46, 48, 49, 50, 51, 56

Screwdriver Sets Big Pack 30, 45, 102

Screwdriver Sets Kraftform 2go 46, 102

Screwdriver Sets XXL 45, 46

Screw Gripper 63

Single Tap Bits 461

Slotted

Bits 376, 377, 378, 379

Bit Sockets 165

Screwdrivers 22, 34, 35, 54, 60, 90

Snake Eye

Bits 400

| | |
|--------------------------------|---|
| Sockets | |
| with Holding Function | 144, 155, 179, 202, 203 |
| Soft-faced Hammers | 514, 515 |
| Spanner | |
| Bits | 400 |
| Square socket screws | |
| Bits | 388, 389, 390, 391 |
| Screwdrivers | 23, 41 |
| Stainless Steel Tools | |
| Bitholding Screwdrivers | 284 |
| Bits | 316, 326, 338, 344, 352, 358, 367, 376, 378, 380, 382, 388, 390, 438, 439 |
| Bit Sets | 438, 439 |
| Kraftform Kompakt | 270, 271 |
| L-Keys | 238, 239, 246 |
| Nutsetters | 401 |
| Screwdrivers | 22, 23, 24, 25, 90, 91 |
| Stepped drill bits | 461 |
| Stubbies | |
| Carburettor Screwdrivers | 44 |
| T-Handle Screwdrivers | 76, 77 |
| Thread drive Bits | 333, 334, 348, 349, 362, 363 |
| Tool-Check | 218, 219, 220 |
| Toolfinder Take it easy | |
| Bit-Checks | 434, 435, 436, 438, 440, 441, 442, 443, 444, 445, 446, 447 |
| Bit-Safes | 440 |
| Bits | 264, 316, 317, 318, 326, 327, 338, 339, 340, 344, 346, 352, 353, 354, 358, 376, 380, 382, 387 |
| Bit Sockets | 204, 205, 206 |
| Joker | 228, 229, 230, 231, 232 |
| L-Keys | 212, 238, 240, 241, 246, 247, 250, 251, 252, 253, 254 |
| Ratchet Sets | 144, 145, 146, 148, 149, 150, 152, 153, 154, 155, 172, 173, 174, 176, 177, 178, 179, 190, 191, 192, 194, 196, 198, 199, 200, 201, 216, 217, 218, 219, 220 |
| Screwdrivers | 22, 23, 24, 25, 34, 35, 36, 37, 38, 39, 45, 44, 45, 46, 48, 49, 50, 51, 90, 91, 94, 95, 96, 97, 98, 99, 102, 103, 104, 105 |
| Sockets | 156, 180, 202, 203 |

Alphabetical Index

All products from A to Z

T

TORQ-SET®

| | |
|--------------|---------------|
| Bits | 392, 393, 394 |
| Screwdrivers | 40 |

Torque Tools

| | |
|------------------------------|--|
| ESD | 473, 474, 475, 481, 483 |
| Insert Tools | 502, 503, 504, 505, 506, 507 |
| Torque-indicators | 486, 487 |
| Torque Screwdrivers | 108, 270, 472, 474, 476, 480, 482 |
| Torque Wrenches Click-Torque | 492, 494, 495, 496, 497, 498, 499, 500 |
| VDE | 108, 114 |

TORX®

| | |
|------------------------------------|---|
| Bits | 352, 353, 354, 355, 356, 358, 359, 360, 361, 362, 363, 364, 365 |
| Bits with Holding Function | 354, 359 |
| Bits with Safety Pin | 357 |
| Bit Sockets with Holding Function | 160, 161, 182, 204, 205 |
| Flagdrivers | 61 |
| L-Keys | 212, 250, 251, 252, 253, 254, 256 |
| L-Keys with holding Function | 240, 246, 250, 254, 256 |
| Screwdrivers | 23, 39, 40, 51, 55 |
| Screwdrivers with holding Function | 38, 50, 66, 80 |

TORX® BO

| | |
|--------------|----------|
| Bits | 366, 367 |
| L-Keys | 212, 254 |
| Screwdrivers | 40, 51 |

TORX PLUS®

| | |
|--------------|---------------|
| Bits | 368, 369, 370 |
| Flagdrivers | 61 |
| Screwdrivers | 40 |

TORX PLUS® IPR

| | |
|--------------|---------------|
| Bits | 372, 373, 374 |
| Screwdrivers | 68, 81 |

TRI-WING®

| | |
|--------------|-----|
| Bits | 395 |
| Screwdrivers | 42 |

U

Unlocking pin 196, 213

V

Vario 289, 292, 293, 294
Voltage tester 101

W

Wera 2go 300, 301, 303
Wera Star 62
Wooden Handle Screwdrivers 60

Z

Zyklop

Accessories 156, 166, 167, 169, 180, 186, 187, 196, 202, 203,
204, 205, 206, 208, 209
Hybrid 194, 196
Metal 144, 146, 152, 153, 154, 155, 176, 177, 178, 179,
198, 199, 200, 201
Mini 216, 217, 218, 219, 220, 222
Mini Accessories 223
Speed 126, 144, 145, 146, 148, 149, 150, 155, 172, 173,
174, 190, 191, 192
VDE 126, 128, 129

Regional Contacts



Wera Werkzeuge GmbH

Korzterter Straße 21-25
42349 Wuppertal

+49 / (0)202 / 40 45 - 311
Fax: +49 / (0)202 / 40 36 34

E-Mail: info@wera.de



Germany

04654 Frohburg
Industrievertretung Jens Hiensch
+49 / (0)157 / 71 90 78 21
E-Mail: jens.hiensch@iv-hiensch.de

26160 Bad Zwischenahn
Ralf Saul
+49 / (0)4403 / 91 00 972
E-Mail: r.saul@wera.de

64342 Seeheim-Jugenheim
Layer OHG
+49 / (0)6257 / 86 96 0
E-Mail: info@layer-ohg.de

09326 Geringswalde
IMS Lonthoff
+49 / (0)1525 / 39 81 570
E-Mail: info@ims-lonthoff.de

42111 Wuppertal
HKL Industrievertretungen GmbH
+49 / (0)202 / 47 00 01
E-Mail: hkl@wera.de

78132 Hornberg
Industrievertretung Markus Haberstroh
+49 / (0)7833 / 955 54 86
E-Mail: m.haberstroh@haberstroh-industrievertretung.de

10961 Berlin
Werksvertretung Peter Raschke
+49 / (0)177 / 74 90 484
E-Mail: raschke@ww-raschke.de

42349 Wuppertal
Dirk Blasius - Verkaufsleiter NRW
+49 / (0)202 / 40 45 204
E-Mail: blasius@wera.de

88489 Wain
Thorsten Schilder Handelsvertretung
+49 / (0)7353 / 528 48 74
E-Mail: thorsten.schilder@wera.de

21465 Reinbek
Rosendahl & Koppel
Inh. Mark Petersen e.K.
+49 / (0)40 / 23 41 47
E-Mail: mark.petersen@roko-petersen.de

58256 Ennepetal
Ulrich Hesselmann
+49 / (0)2333 / 83 92 37
E-Mail: ulrich.hesselmann@wera.de

90455 Nürnberg
Dietz OHG
+49 / (0)9129 / 90 57 50
E-Mail: dietz@wera.de

Europe

AT - 5412 Puch
Alpen-MayKestag GmbH
+43 / (0)662 / 44 901-0
E-Mail: verkauf@a-mk.com

B - 1600 Sint-Pieters-Leeuw
Beltracy S.A.
+32 / (0)2 / 54 36 890
E-Mail: info@beltracy.be

BG - 1421 Sofia
Mr. Nikola Ivanov
+359 / (0)2 / 96 31 900
E-Mail: weraw@mail.bg

CH - 1026 Denges
Metalsa SA
+41 / (0)21 / 80 45 050
E-Mail: info@metalsa.ch

CZ - 180 82 Praha 8
ABQ AGENCY s.r.o.
+420 / (0)2 / 28 38 41 981
E-Mail: info@abefekt.cz

DK - 2730 Herlev
HJS Værktøj A/S
+45 / 44 84 40 44
E-Mail: hjs@hjs.dk

Wera Iberia
C./Mogoda, 1-5 (Edificio Nodus)
Pno. Ind. Can Salvatella
E - 08210 Barberà del Vallès / Barcelona
+34 / 93 / 7 29 7-2 40
Fax: +34 / 93 / 7 29 7-2 41
E-Mail: juan.pires@weraspain.com

EST - 1415 Tallinn
AS Stokker
+372 / 6 / 20 11 11
E-Mail: timmo.eenmaa@stokker.com

EST - 12618 Tallinn
Toolmarketing OÜ
+372 / 6 / 09 64 36
E-Mail: info@toolmarketing.eu

Wera Outillages S.A.S.
13, rue Ampère
F - 67500 Haguenau
+33 9 72 61 16 52
E-Mail: info@wera-outillages.fr

FIN - 01511 Vantaa
Wihuri Oy Technical Trade
+358 / (0)20 / 51 02 364
E-Mail: info@wihuri.fi

Wera Tools UK Ltd.
Units 1 & 2, McGregor's Way
Turnoaks Business Park
GB - Chesterfield S40 2WB
+44 / (0)1246 / 27 77 56
Fax: +44 / (0)1246 / 27 33 35
E-Mail: queries@wera-tools.co.uk

GR - 166 72 Vari
Costas J. Kessissoglou
+30 / 210 / 96 37 521
E-Mail: kessi@hol.gr

I - 20097 San Donato Milanese
Carlo Stechel & Figli srl
+39 / 02 52 77 71
E-Mail: wera@stechel.it

For more regional contacts please see

www.wera.de, www.weratools.com and www.wera-tools.co.uk

Regional Contacts

Europe

 **LT-69320 Klaipėdos raj.**
UAB GITANA
+370 / 46 / 410881
E-Mail: info@gitana.lt

 **N - 0787 Oslo**
MORGENSTIERNE verktøy AS
+47 / (0)22 / 49 28 00
E-Mail: tools@morgenstierne.no

  **NL - Nord**
Gerard Kluck
+31 / 65 28 52 622
E-Mail: kluck@wera.de

  **NL - Süd**
Wouter Steijvers
+31 / 65 28 50 162
E-Mail: steijvers@wera.de

 **PL - 61-306 Poznań**
Agentools Sp. z o.o. Sp. k.
+48 / (0)61 / 87 19 000
E-Mail: info@agentools.pl

 **RO-400441 Cluj-Napoca**
Mr. Victor Martes
+40 / 741 / 072 479
E-Mail: rominfocom@gmail.com

 **RUS - 119454 Moskau**
KNIPEX 000
+7 / 495 / 73 73 497
E-Mail: info@knipecx.ru



 **RUS-143581 Moskau**
000 „ЦИТ“ ЦЕНТРОИНСТРУМЕНТ
+7- / 495 / 789 73 14/15
E-Mail: wera@centro-i.ru

 **S - 163 53 Spånga**
Hansson & Frife AB
+46 / (0)8 / 76 02 510
E-Mail: hansson.frife@esma.se

 **SRB-11030 Beograd**
ELTEC Export-Import d.o.o
+381 / 11 / 3555 - 065
E-Mail: info@eltec.rs

North America (Canada, USA, Mexico)

  **CA - Burlington, Ontario**
Wera Tools Inc.
1 - 800 - 267 - 5541
E-Mail: info@weratools.com

  **CA - Burlington, Ontario**
Wera Tools Inc.
1 - 800 - 267 - 5541
E-Mail: info@weratools.com

  **CA - Burlington, Ontario**
Wera Tools Inc.
+ 1 - 905 - 637 - 0003
E-Mail: info@weratools.com

South America

 **AR - 1879 Buenos Aires**
Quilmes Neumática S.A.
+54 / 11 42 50 03 65 int.21
E-Mail: rudi@quilmesneumatica.com

 **BR - 09601-000 São Bernardo do Campo-SP**
DFG Comércio Importação
Exportação e Representação Ltda
+55 / 11 49 41 21 51
E-Mail: www.dfgferramentas.com.br

 **CL - Santiago de Chile**
Comercial e Industrial Ilesa S.A.
+56 / 23 62 70 00

Australia and Oceania

 **AU - Australia - 2147 Seven Hills**
Cabac
+61 / 13 31 22
E-Mail: sales@cabac.com.au

 **NZ - 1060 Auckland**
Ecco Pacific Ltd.
+64 0800 77 6969
E-Mail: sales@cabac.co.nz

 **NZ - 8023 Christchurch**
Blacks Fasteners
+64-3-3652460
E-Mail: sydenham@blacksfasteners.co.nz

Asia

 **CN - 201206 Shanghai**
KNIPEX Tools Co., Ltd.
+86 / 21 58 99 80 10
E-Mail: info@knipecx.com.cn

  **Wera Tools Japan G.K.**
+81 70 4813 1142
E-Mail: frank.yang@wera.de

 **SG - 575625 Singapore**
Wing Poh Hardware Pte Ltd
+65 / 62 50 05 23

 **Matfron Industrial Automatic**
(Shanghai) Co., Ltd
+86 / 021 / 66 24 91 22
E-Mail: service@matfron.com

 **IN - 411001 Pune**
Nikita Distributors & Extreme
Adventure Sports
+91 / 20 30 50 06 14
E-Mail: raman.jpa@gmail.com

 **TW - 114 Taipei City / Taiwan R.O.C**
Inhand Corporation
+886 / 2 / 63 19 53 8

 **KR - 10463 Gyunggi-Do**
LnJ Korea
+82 / 31 / 96 61 429
E-Mail: LNJ2100@ymail.com

 **IN - 600 125 Chennai**
Rapidtec Enterprises
+91 994 036 6621
E-Mail: rapidtec2011@gmail.com

 **TW - 11483 Taipei / Taiwan R.O.C.**
Duramet Corporation
+886 / 2 / 26 32 24 88

 **KR - 08531 Seoul**
Protool Co., LTD.
E-Mail: sejin@protool.co.kr

 **VN - Ho Chi Minh City, Vietnam**
THE GIOI MOI EQUIPMENT AND ENGINEERING
SOLUTION JOINT STOCK COMPANY (THE GIOI MOI JSC)
+84-28-66 80 88 75
E-Mail: thegioimoijscvn@gmail.com

Middle East

 **IL - Tel-Aviv 61573**
Tenegal Agencies Ltd.
+972 / (0)3 / 56 17 411
E-Mail: menahem@tenegal.com

JO, LB, IR, SY, KW, BH, QA, OM, AE, SA, JE
KNIPEX Tools Middle East FZE
+971 / 48 87 85 56
E-Mail: info@knipecx-tools.com

 **IR - 15866-45915 Tehran / Iran**
Abzarsara Co.
+98 / 21 88 81 31 20
E-Mail: info@abzarsara.com



 **IR - 15866-45915 Tehran / Iran**
FourSat Kish Co Ltd.
+98 / 21 88 60 24 84
E-Mail: arash.etminan@foursat.com

Which type of bit is needed for which job?



Impaktor-Bits

Impact-Bits are needed when a strong power tool (e.g. 18 volt impact screwdriver) is used. Impact bits were specifically developed to withstand high power tool forces.



TH-Bits

TH-Bits are hard bits with a torsion zone. Torsion bits absorb the damaging peak torque loads in the torsion zone. This prevents premature wear and enhances the service life of the bits.



Stainless Steel-Bits

Wera stainless steel bits are manufactured out of stainless steel so unsightly rust can be avoided. The stainless steel bits from Wera are vacuum ice-hardened and have the hardness and strength needed for screw connections. There are no limitations to the industrial applications they are suitable for.



J-Bits

J stands for Japan. J bits have been optimised to suit Asian PH screws. In particular, they are for use with very small dimensions as set out in the Japanese Camera Standard.



BDC-Bits

BDC-Bits are absolutely premium products. They have a softer BiTorsion zone which reduces the hardness of the shaft by about 20 % in comparison to the drive tip. This means that the peak loads that cause bit breakage and premature wear are absorbed in this zone – something which enhances the service life of the bits. The diamond coating lowers the danger of slipping as the minute diamond particles literally “bite” themselves into the screw head. B stands for BiTorsion. DC stands for diamond coated.



ACR®-Bits

ACR® stands for “anti-cam-out ribs”. ACR® bits have ribs at the drive tip that protect against slipping out of the screw head. It is recommended that ACR® bits are matched with ribbed ACR® screws for maximum effect. ACR® is a registered trademark of Phillips Screw Company.



BTH-Bits

BTH-Bits have an additional tempered BiTorsion zone, which reduces the hardness of the shaft by about 20 % in comparison to the drive tip. This means that the peak loads that cause bit breakage and premature wear are absorbed in this zone – something which enhances the service life of the bits.



TiN-Bits

TiN stands for titanium-nitrite. An extremely hard coating to withstand permanent loads such as during continual screwdriving operations in series manufacturing.



BTZ-Bits

BTZ-Bits have an additional tempered BiTorsion zone, which reduces the hardness of the shaft by about 20 % in comparison to the drive tip. This means that the peak loads that cause bit breakage and premature wear are absorbed in this zone – something which enhances the service life of the bits.



DC-Bits

The diamond coating of the DC bits lowers the danger of slipping as the minute diamond particles literally “bite” themselves into the screw head.



TZ-Bits

TZ-Bits are tough bits with a torsion zone. Torsion bits absorb the damaging peak torque loads in the torsion zone. This prevents premature wear and enhances the service life of the bits.



Bits with reduced shaft diameter

Bits with reduced shaft diameter ensure that screws can be sunk without damaging the surface. This is particularly necessary in drywall construction applications.



A-Bits

A stands for aviation. A bits are particularly hard bits with a sharp-edged profile which e.g. penetrates screw profiles full of paint (such as on fuselage panels) ensuring a dependable transfer of force between the bit and the screw.

Imprint

Subject to technical modifications!

Any reprinting – even only excerpts – shall only be permissible with the prior written consent of the company Wera Werkzeuge GmbH.

Edition: EN 2018

Printed in Germany

Trademarks used:

| | |
|-----------------|---|
| ACR | Phillips Screw Company |
| ASSY | Adolf Würth GmbH & Co. KG |
| AW | Adolf Würth GmbH & Co. KG |
| HIOS | Totsu, Katsuyuki |
| Microstix | OSG System Products Co. Ltd. |
| Phillips Recess | Phillips Screw Company |
| Pozidriv | registered trademark for Phillips Screw Company in Canada, Mexico and in the USA; for Trifast plc in the UK |
| PZ | registered trademark for Phillips Screw Company in Canada, Mexico and in the USA |
| PZ1, PZ2, PZ3 | registered trademark in the USA for Phillips Screw Company |
| Robertson | British Robertson S.L.U. |
| SDS plus | Robert Bosch GmbH |
| SIT | Adolf Würth GmbH & Co. KG |
| SPAX | SPAX International GmbH & Co. KG |
| T-STAR plus | SPAX International GmbH & Co. KG |
| TORQ-SET | Phillips Screw Company |
| TORX | Acument Intellectual Properties, LLC, Troy, Mich., US |
| TORX PLUS | Acument Intellectual Properties, LLC, Troy, Mich., US |
| TRI-WING | Phillips Screw Company |

We reserve the right to modify without prior notification any details stated in this catalogue regarding product features, versions and designs.

No liability for printing errors or mistakes shall be assumed.



Contact us

All regions (except for North America, UK and Republic of Ireland)

Wera Werkzeuge GmbH · Germany
Korzter Straße 21–25
D-42349 Wuppertal

Phone: +49 (0) 202 / 40 45-0
Fax: +49 (0) 202 / 40 36 34
E-Mail: info@wera.de

Internet:
www.wera.de

North America

Wera Tools Inc.
4129 Harvester Rd, Unit H
Burlington, Ontario
Canada, L7L 5M3

Phone: 1-800-267-55 41
E-Mail: info@weratools.com

Internet:
www.weratools.com

UK & Republic of Ireland

Wera Tools UK LTD
Units 1 & 2, McGregor's Way
Turnoaks Business Park, Chesterfield
Derbyshire, S40 2WB
Great Britain

Phone: +44 / (0) 12 46 / 27 77 56
E-Mail: queries@wera-tools.co.uk

Internet:
www.wera-tools.co.uk

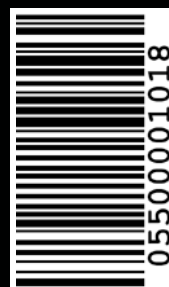

EN 05 500001 018 - 0052570 - 01

X-ON Electronics

Largest Supplier of Electrical and Electronic Components

Click to view similar products for [Tool Kits & Cases](#) category:

Click to view products by [Wera](#) manufacturer:

Other Similar products are found below :

[217434-1](#) [4263](#) [1055420-1](#) [11-18-3023](#) [63860-8170](#) [856600-2](#) [690372163](#) [11-40-3247](#) [63883-2870](#) [63885-0270](#) [63901-5670](#) [63866-1070](#)
[63863-5070](#) [63892-7370](#) [11-18-3209](#) [63860-4070](#) [63881-0970](#) [A0403641](#) [11-18-3040](#) [63865-2070](#) [63910-1470](#) [63861-5070](#) [63850-7470](#)
[11-18-3201](#) [63910-7570](#) [FM 0501 146](#) [63883-0670](#) [63830-0070](#) [63902-9170](#) [11-18-3147](#) [11-18-3079](#) [63883-2670](#) [63900-1770](#) [11-18-3190](#)
[63851-1070](#) [63912-4770](#) [63911-5270](#) [63895-1070](#) [63860-1470](#) [63850-6070](#) [1-69411-3](#) [63852-9270](#) [63802-6270](#) [63902-4870](#) [11-18-3202](#)
[63852-9170](#) [63850-1070](#) [63830-0170](#) [63910-2870](#) [11-18-3010](#)