

**DC Power Cable 1.5m long , PLUG 2.1x5.5 mm - angled**  
flexible, multiwire conductors,  
stranded of bare copper wires  
**2x0.75mm<sup>2</sup>**

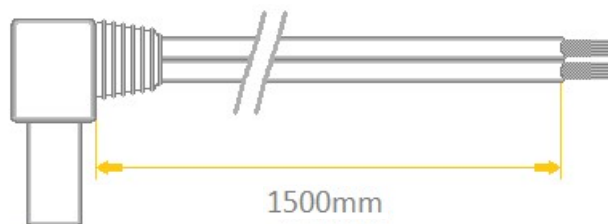

Model	A21-TT-T075-150BK
DC Plug (output)	<b>2.1x5.5mm, angled</b> (round plug, outer diameter 5.5mm, inner diameter 2.1mm)
DC Socket (input)	tinned terminals
Construction	flexible, multiwire conductors, stranded of bare annealed copper wires
Cable cross section	2.3 x 4.8mm
Wire diameter	<b>2x0.75mm<sup>2</sup></b>
Nominal voltage	0-100V
Rated current	2.3A
Length	150cm
Jacket	PVC
Color	Black
Inner conductor	Cu
Insulation resistance	>100MΩ @ 500VDC
Insulation thickness	0.4mm
Allowable operation temperature	-20°C to 70°C
Maximum wire resistance	26.0 Ω/km @ 20°C

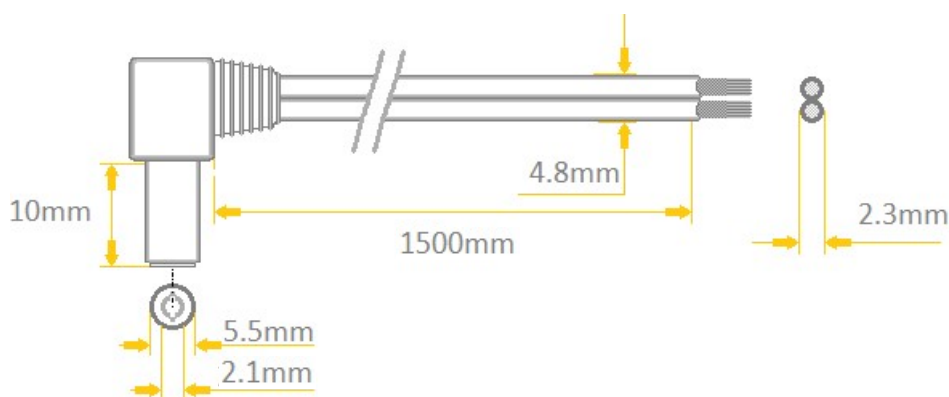

## Marking System

model:

**A21-TT-T075-150BK**

1	2	3	4	5	6	7	8
A	21	-	T T	-	T	075	- 150 BK

1	Input / Output (side 1)	<p>P - straight plug</p> <p>A - angled plug</p> <p>S - socket</p>
2	Plug / Socket dimensions (side 1)	<p>07 - 0.7mm / 2.35mm</p> <p>13 - 1.3mm / 3.5mm</p> <p>40 - 1.7mm / 4.0mm</p> <p>48 - 1.7mm / 4.8mm</p> <p>55 - 1.7mm / 5.5mm</p> <p>21 - 2.1mm / 5.5mm</p> <p>25 - 2.5mm / 5.5mm</p>
3	Input / Output (side 2)	<p>P - straight plug</p> <p>A - angled plug</p> <p>S - socket</p>
4	Plug / Socket dimensions (side 2)	<p>T - tinned terminals</p> <p>07 - 0.7mm / 2.35mm</p> <p>13 - 1.3mm / 3.5mm</p> <p>40 - 1.7mm / 4.0mm</p> <p>48 - 1.7mm / 4.8mm</p> <p>55 - 1.7mm / 5.5mm</p> <p>21 - 2.1mm / 5.5mm</p> <p>25 - 2.5mm / 5.5mm</p>
5	cable type	<p>C- YTLYek (coaxial)</p> <p>T- TLYP</p> <p>O- YTLY</p>
6	wire diameter	<p>035 - 0.35mm<sup>2</sup></p> <p>050 - 0.5mm<sup>2</sup></p> <p>075 - 0.75mm<sup>2</sup></p> <p>100 - 1.0mm<sup>2</sup></p>
7	length	<p>050 - 500mm</p> <p>150 - 1500mm</p>
8	color	<p>BK - black</p> <p>WH - white</p> <p>TR - transparent</p>

## X-ON Electronics

Largest Supplier of Electrical and Electronic Components

*Click to view similar products for [DC Power Cords](#) category:*

*Click to view products by [WEST POL](#) manufacturer:*

Other Similar products are found below :

[2R6006A20A120](#) [172-4000](#) [172-4101](#) [21033836407](#) [2J-1865A](#) [2R7006A20A120](#) [426055400-3](#) [420680840-3](#) [96CB-POWER-B-1.8M2](#)  
[2052KH2-BK](#) [804001P03M050G](#) [2050KH1-BK](#) [216603-0037](#) [862545-5](#) [BXC-10567](#) [172-2555](#) [32102-022800-200-RS](#) [DC.CAB.8000.0300](#)  
[DC.CAB.6400.0200](#) [AK-ND-C07](#) [AK-ND-C16](#) [DC.CAB.4600.0200](#) [DC.CAB.8400.0020](#) [DC.CAB.4201.0150](#) [DC.CAB.8200.0300](#)  
[DC.CAB.6601.0200](#) [DC.CAB.6601.0020](#) [DC.CAB.4201.0200](#) [DC.CAB.8010.0020](#) [AK-ND-C12](#) [AK-ND-C06](#) [DC.EXT.4200.0300](#)  
[DC.EXT.6200.0300](#) [DC.EXT.8200.0300](#) [DC.CAB.8400.0500](#) [DC.EXT.8610.0100](#) [DC.EXT.4600.0300](#) [AK-ND-C08](#) [AK-ND-C01](#)  
[DC.CAB.6201.0200](#) [DC.CAB.8610.0020](#) [DC.CAB.8600.0500](#) [DC.EXT.8200.0500](#) [DC.CAB.8010.0150](#) [DC.EXT.6200.0100](#)  
[DC.CAB.8410.0300](#) [DC.EXT.4200.0200](#) [AK-ND-C14](#) [AK-ND-C11](#) [DC.EXT.8610.0500](#)