

White DC Power Cable 1.5m long
Plug 2.5x5.5 mm – angled
Socket 2.1x5.5 mm
 flexible, multiwire conductors,
 stranded of bare copper wires
 coaxial **1.00mm²**

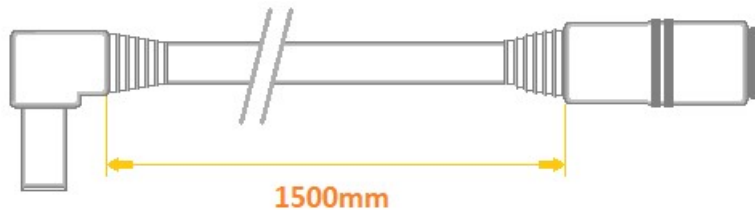

Model	A25-C21-C100-150WH
DC Plug (output)	2.5x5.5mm, straight (round plug, outer diameter 5.5mm, inner diameter 2.5mm)
DC Socket (input)	2.1x5.5mm, straight (round socket, outer diameter 2.1mm, inner diameter 5.5mm)
Construction	flexible, multiwire conductors, stranded of bare annealed copper wires - coaxial
Cable cross section	3.95mm
Wire diameter	1mm²
Nominal voltage	0-100V
Rated current	5A
Length	150cm
Jacket	PVC
Color	White
Inner conductor	Cu
Insulation resistance	>100MΩ @ 500VDC
Insulation thickness	0.4mm
Allowable operation temperature	-20°C to 70°C
Maximum wire resistance	18.0 Ω/km @ 20°C

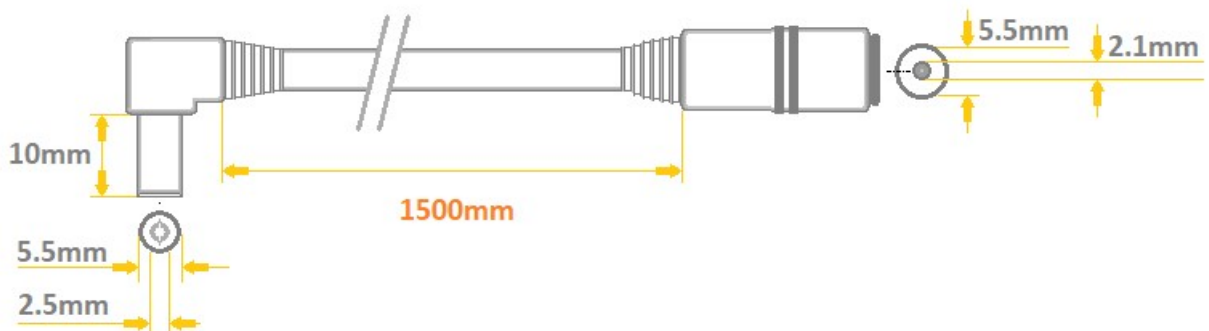

Marking System				model:		A25-C21-C100-150WH				
1	2	3	4	5	6	7	8			
A	25	-	C	21	-	C	100	-	150	WH
1	Input / Output (side 1)				P - straight plug A - angled plug C - socket					
2	Plug / Socket dimensions (side 1)				07 - 0.7mm / 2.35mm 13 - 1.3mm / 3.5mm 40 - 1.7mm x 4.0mm 48 - 1.7mm x 4.8mm 55 - 1.7mm / 5.5mm 21 - 2.1mm / 5.5mm 25 - 2.5mm x 5.5mm					
3	Input / Output (side 2)				P - straight plug A - angled plug C - socket					
4	Plug / Socket dimensions (side 2)				T - tinned terminals 07 - 0.7mm / 2.35mm 13 - 1.3mm / 3.5mm 40 - 1.7mm x 4.0mm 48 - 1.7mm x 4.8mm 55 - 1.7mm / 5.5mm 21 - 2.1mm / 5.5mm 25 - 2.5mm x 5.5mm					
5	cable type				C- YTLYek (coaxial) T- TLYP					
6	wire diameter				035 - 0.35mm ² 050 - 0.5mm ² 075 - 0.75mm ² 100 - 1.0mm ²					
7	length				050 - 500mm 150 - 1500mm					
8	color				BK - black WH - white TR - transparent					

X-ON Electronics

Largest Supplier of Electrical and Electronic Components

Click to view similar products for [DC Power Cords](#) category:

Click to view products by [WEST POL](#) manufacturer:

Other Similar products are found below :

[2R6006A20A120](#) [172-4000](#) [172-4101](#) [21033836407](#) [2J-1865A](#) [2R7006A20A120](#) [426055400-3](#) [420680840-3](#) [96CB-POWER-B-1.8M2](#)
[2052KH2-BK](#) [804001P03M050G](#) [2050KH1-BK](#) [216603-0037](#) [862545-5](#) [BXC-10567](#) [172-2555](#) [32102-022800-200-RS](#) [DC.CAB.8000.0300](#)
[DC.CAB.6400.0200](#) [AK-ND-C07](#) [AK-ND-C16](#) [DC.CAB.4600.0200](#) [DC.CAB.8400.0020](#) [DC.CAB.4201.0150](#) [DC.CAB.8200.0300](#)
[DC.CAB.6601.0200](#) [DC.CAB.6601.0020](#) [DC.CAB.4201.0200](#) [DC.CAB.8010.0020](#) [AK-ND-C12](#) [AK-ND-C06](#) [DC.EXT.4200.0300](#)
[DC.EXT.6200.0300](#) [DC.EXT.8200.0300](#) [DC.CAB.8400.0500](#) [DC.EXT.8610.0100](#) [DC.EXT.4600.0300](#) [AK-ND-C08](#) [AK-ND-C01](#)
[DC.CAB.6201.0200](#) [DC.CAB.8610.0020](#) [DC.CAB.8600.0500](#) [DC.EXT.8200.0500](#) [DC.CAB.8010.0150](#) [DC.EXT.6200.0100](#)
[DC.CAB.8410.0300](#) [DC.EXT.4200.0200](#) [AK-ND-C14](#) [AK-ND-C11](#) [DC.EXT.8610.0500](#)