

**Black DC Power Cable 1.5m long**  
**Plug 2.5x5.5 mm – straight**  
**Socket 2.5x5.5 mm**  
 flexible, multiwire conductors,  
 stranded of bare copper wires  
 coaxial **1.00mm<sup>2</sup>**

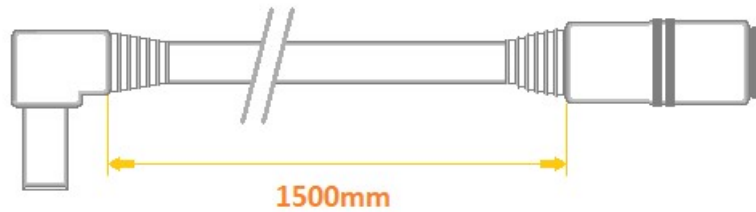

Model	A25-C25-C100-150BK
DC Plug (output)	<b>2.5x5.5mm, angled</b> (round plug, outer diameter 5.5mm, inner diameter 2.5mm)
DC Socket (input)	<b>2.5x5.5mm, straight</b> (round socket, outer diameter 2.5mm, inner diameter 5.5mm)
Construction	flexible, multiwire conductors, stranded of bare annealed copper wires - coaxial
Cable cross section	3.95mm
Wire diameter	<b>1.0 mm<sup>2</sup></b>
Nominal voltage	0-100V
Rated current	5A
Length	150cm
Jacket	PVC
Color	Black
Inner conductor	Cu
Insulation resistance	>100MΩ @ 500VDC
Insulation thickness	0.3mm
Allowable operation temperature	-20°C to 70°C
Maximum wire resistance	18.0 Ω/km @ 20°C

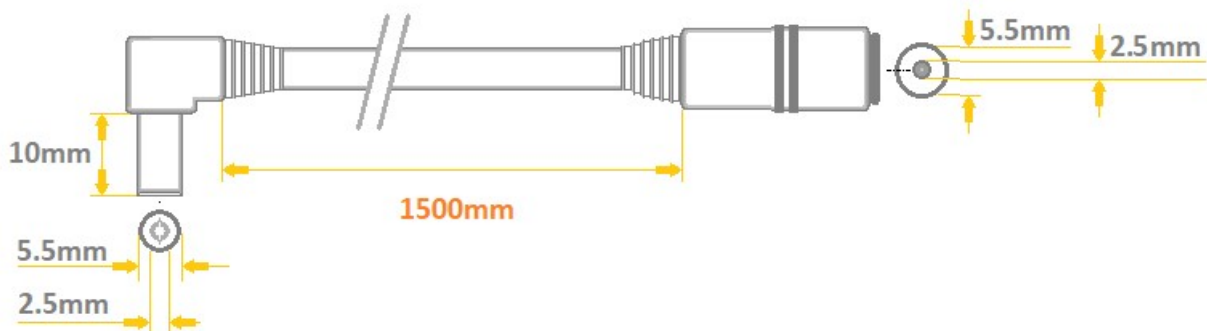

Marking System				model:				<b>A25-C25-C100-150BK</b>			
1	2	3	4	5	6	7	8				
<b>A</b>	<b>25</b>	<b>-</b>	<b>C</b>	<b>25</b>	<b>-</b>	<b>C</b>	<b>100</b>	<b>-</b>	<b>150</b>	<b>BK</b>	
<b>1</b>	<b>Input / Output (side 1)</b>				P - straight plug A - angled plug C - socket						
<b>2</b>	<b>Plug / Socket dimensions (side 1)</b>				07 - 0.7mm / 2.35mm 13 - 1.3mm / 3.5mm 40 - 1.7mm x 4.0mm 48 - 1.7mm x 4.8mm 55 - 1.7mm / 5.5mm 21 - 2.1mm / 5.5mm 25 - 2.5mm x 5.5mm						
<b>3</b>	<b>Input / Output (side 2)</b>				P - straight plug A - angled plug C - socket						
<b>4</b>	<b>Plug / Socket dimensions (side 2)</b>				T - tinned terminals 07 - 0.7mm / 2.35mm 13 - 1.3mm / 3.5mm 40 - 1.7mm x 4.0mm 48 - 1.7mm x 4.8mm 55 - 1.7mm / 5.5mm 21 - 2.1mm / 5.5mm 25 - 2.5mm x 5.5mm						
<b>5</b>	<b>cable type</b>				C- YTLYek (coaxial) T- TLYP						
<b>6</b>	<b>wire diameter</b>				035 - 0.35mm <sup>2</sup> 050 - 0.5mm <sup>2</sup> 075 - 0.75mm <sup>2</sup> 100 - 1.0mm <sup>2</sup>						
<b>7</b>	<b>length</b>				050 - 500mm 150 - 1500mm						
<b>8</b>	<b>color</b>				BK - black WH - white TR - transparent						

## X-ON Electronics

Largest Supplier of Electrical and Electronic Components

*Click to view similar products for [DC Power Cords](#) category:*

*Click to view products by [WEST POL](#) manufacturer:*

Other Similar products are found below :

[2R6006A20A120](#) [172-4000](#) [172-4101](#) [21033836407](#) [2J-1865A](#) [2R7006A20A120](#) [426055400-3](#) [420680840-3](#) [96CB-POWER-B-1.8M2](#)  
[2052KH2-BK](#) [804001P03M050G](#) [2050KH1-BK](#) [216603-0037](#) [862545-5](#) [BXC-10567](#) [172-2555](#) [32102-022800-200-RS](#) [DC.CAB.8000.0300](#)  
[DC.CAB.6400.0200](#) [AK-ND-C07](#) [AK-ND-C16](#) [DC.CAB.4600.0200](#) [DC.CAB.8400.0020](#) [DC.CAB.4201.0150](#) [DC.CAB.8200.0300](#)  
[DC.CAB.6601.0200](#) [DC.CAB.6601.0020](#) [DC.CAB.4201.0200](#) [DC.CAB.8010.0020](#) [AK-ND-C12](#) [AK-ND-C06](#) [DC.EXT.4200.0300](#)  
[DC.EXT.6200.0300](#) [DC.EXT.8200.0300](#) [DC.CAB.8400.0500](#) [DC.EXT.8610.0100](#) [DC.EXT.4600.0300](#) [AK-ND-C08](#) [AK-ND-C01](#)  
[DC.CAB.6201.0200](#) [DC.CAB.8610.0020](#) [DC.CAB.8600.0500](#) [DC.EXT.8200.0500](#) [DC.CAB.8010.0150](#) [DC.EXT.6200.0100](#)  
[DC.CAB.8410.0300](#) [DC.EXT.4200.0200](#) [AK-ND-C14](#) [AK-ND-C11](#) [DC.EXT.8610.0500](#)