

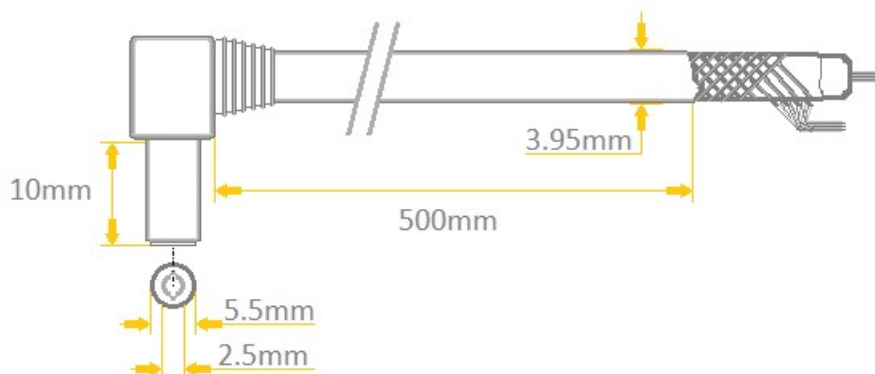

DC Power Cable 0.5m long , PLUG 2.5x5.5 mm - angled
flexible, multiwire conductors,
stranded of bare copper wires
coaxial **1.00mm²**



Model	A25-TT-C100-050BK
DC Plug (output)	2.5x5.5mm, angled (round plug, outer diameter 5.5mm, inner diameter 2.5mm)
DC Socket (input)	tinned terminals
Construction	flexible, multiwire conductors, stranded of bare annealed copper wires
Cable cross section	3.95mm
Wire diameter	1.00 mm² (coaxial)
Nominal voltage	0-100V
Rated current	5A
Length	50cm
Jacket	PVC
Color	Black
Inner conductor	Cu
Insulation resistance	>100MΩ @ 500VDC
Insulation thickness	0.3mm
Allowable operation temperature	-20°C to 70°C
Maximum wire resistance	18.0 Ω/km @ 20°C



Marking System

model:

A25-TT-C100-050BK

1	2	3	4	5	6	7	8		
A	25	-	T T	-	C	100	-	050	BK

1	Input / Output (side 1)	<p>P - straight plug</p> <p>A - angled plug</p> <p>S - socket</p>
2	Plug / Socket dimensions (side 1)	<p>07 - 0.7mm / 2.35mm</p> <p>13 - 1.3mm / 3.5mm</p> <p>40 - 1.7mm / 4.0mm</p> <p>48 - 1.7mm / 4.8mm</p> <p>55 - 1.7mm / 5.5mm</p> <p>21 - 2.1mm / 5.5mm</p> <p>25 - 2.5mm / 5.5mm</p>
3	Input / Output (side 2)	<p>P - straight plug</p> <p>A - angled plug</p> <p>S - socket</p>
4	Plug / Socket dimensions (side 2)	<p>T - tinned terminals</p> <p>07 - 0.7mm / 2.35mm</p> <p>13 - 1.3mm / 3.5mm</p> <p>40 - 1.7mm / 4.0mm</p> <p>48 - 1.7mm / 4.8mm</p> <p>55 - 1.7mm / 5.5mm</p> <p>21 - 2.1mm / 5.5mm</p> <p>25 - 2.5mm / 5.5mm</p>
5	cable type	<p>C- YTLYek (coaxial)</p> <p>T- TLYP</p> <p>O- YTLY</p>
6	wire diameter	<p>035 - 0.35mm²</p> <p>050 - 0.5mm²</p> <p>075 - 0.75mm²</p> <p>100 - 1.0mm²</p>
7	length	<p>050 - 500mm</p> <p>150 - 1500mm</p>
8	color	<p>BK - black</p> <p>WH - white</p> <p>TR - transparent</p>

X-ON Electronics

Largest Supplier of Electrical and Electronic Components

Click to view similar products for [DC Power Cords](#) category:

Click to view products by [WEST POL](#) manufacturer:

Other Similar products are found below :

[2R6006A20A120](#) [172-4000](#) [172-4101](#) [21033836407](#) [2J-1865A](#) [2R7006A20A120](#) [426055400-3](#) [420680840-3](#) [96CB-POWER-B-1.8M2](#)
[2052KH2-BK](#) [804001P03M050G](#) [2050KH1-BK](#) [216603-0037](#) [862545-5](#) [BXC-10567](#) [172-2555](#) [32102-022800-200-RS](#) [DC.CAB.8000.0300](#)
[DC.CAB.6400.0200](#) [AK-ND-C07](#) [AK-ND-C16](#) [DC.CAB.4600.0200](#) [DC.CAB.8400.0020](#) [DC.CAB.4201.0150](#) [DC.CAB.8200.0300](#)
[DC.CAB.6601.0200](#) [DC.CAB.6601.0020](#) [DC.CAB.4201.0200](#) [DC.CAB.8010.0020](#) [AK-ND-C12](#) [AK-ND-C06](#) [DC.EXT.4200.0300](#)
[DC.EXT.6200.0300](#) [DC.EXT.8200.0300](#) [DC.CAB.8400.0500](#) [DC.EXT.8610.0100](#) [DC.EXT.4600.0300](#) [AK-ND-C08](#) [AK-ND-C01](#)
[DC.CAB.6201.0200](#) [DC.CAB.8610.0020](#) [DC.CAB.8600.0500](#) [DC.EXT.8200.0500](#) [DC.CAB.8010.0150](#) [DC.EXT.6200.0100](#)
[DC.CAB.8410.0300](#) [DC.EXT.4200.0200](#) [AK-ND-C14](#) [AK-ND-C11](#) [DC.EXT.8610.0500](#)