



CATALOGUE2020

**wiha**   
Tools that work for you

# TOOL TOOL S







## Wiha – our goal: your success

- **Your guarantee for quality**  
Winner of the Manufacturing Excellence Awards 2014 as the best SME in Germany.
- **Reliable and dependable**  
German family-owned company with more than 80 years of experience.
- **Your advantage**  
Customised problem-solving for professionals.
- **Cutting-edge technology**  
Award-winning innovations valued by professionals throughout the world.

What makes your work easier? Tools that increase your efficiency, reduce costs and preserve your health. This is why Wiha develops, designs and manufactures products that meet the highest functionality, durability and ergonomic demands.

Founded over 80 years ago as a small family-owned business for standard parts and screws, Wiha has grown to become a global company with factories all over Europe, Asia and the United States and are still owner-operated by the Hahn family.

Wiha offers the professional a wide range of high-quality premium tools, characterized by their use of the latest manufacturing technologies, application-oriented innovations, ergonomic superiority, top quality, absolute reliability and long service life. In short, tools that make your work noticeably easier - tools that work for you.

Learn more about Wiha on our website:  
[www.wiha.com](http://www.wiha.com)





# Wiha visions and values

## With responsibility and innovation, Wiha is set for a successful future.

---

What makes a company successful? Providing excellent products and having a good company culture are key. The high quality of Wiha tools in their form and functionality is confirmed by the many international awards they have received. As an owner-operated family-owned company, we foster a culture of togetherness. From employee development to active customer management, Wiha does everything they can to create optimum working and business conditions and a foundation for sustainable success.

As a member of the BME Compliance Initiative, Wiha complies with a code of conduct which obligates the company to follow business conduct rules, principles of social responsibility and the obligation to promote suppliers, ensuring the lawful behaviour of the company and its employees.

In 2016, Wiha was crowned one of the TOP 100 most innovative mid-sized companies in Germany. Thanks to their practised culture of innovation, Wiha was able to succeed at the competition held as part of the "German Mid-Sized Company Summit." We took this as encouraging confirmation of our company philosophy, which focusses on progress and vision.

---

### Wiha – our visions

- **A financially successful family-owned company**  
For more than 80 years, Wiha has been a successful owner-operated company in the market.
  - **Premium international brand**  
Wiha supplies an international market from factories in Europe, Asia and the USA.
  - **Highly motivated first-class team:**  
Wiha employees are competent, committed and motivated thanks to their optimum working conditions.
  - **User- and application-focused:**  
Wiha products enable the user to work in an efficient and health-friendly way.
-

# Wiha design awards

## Ergonomics, highly prized by all.

To us, positive feedback from people for whom we make our tools is the most rewarding confirmation of our work. All the same, we can also be more than a little proud when the high ergonomic quality of our products is confirmed at the "highest" level, as many of them have been distinguished with coveted design awards. In addition to this, our company and production quality were also honoured with awards. With this praise and confirmation from every direction, it's no wonder that Wiha are on the right track with ergonomic tool concepts and a future-oriented philosophy.

**26one®**  
2015 / 2017 / 2018



**GERMAN  
DESIGN  
AWARD  
WINNER  
2018**



reddot design award  
winner 2017



Focus Open 2017  
Silver

**speedE®**  
2018 / 2019



**GERMAN  
INNO  
VATION  
AWARD '19  
GOLD**



**GERMAN  
DESIGN  
AWARD  
GOLD  
2019**



Focus Open 2018  
Special Mention



**slimBit electric bit set**  
2019



reddot award 2019  
winner



Focus Open 2019  
Silver

**Torque QuickCheck**  
2020



# Wiha tools with AGR approval

## The world's first tools awarded the seal of approval for efficient and health-preserving work.

---



Geprüft und empfohlen vom Forum: Gesunder Rücken - besser leben e.V. und dem Bundesverband deutscher Rückenschulen (BdR) e.V. Weitere Infos bei: AGR e.V., Stader Str. 6, 27432 Bremervörde, Tel. 04761/92 63 580, [www.agr-ev.de](http://www.agr-ev.de)

### Ergonomic excellence!

Wiha is the world's first hand tool manufacturer to receive the AGR seal for its Inomic® pliers and ergonomic handle design on screwdrivers. This distinction enjoys broad acceptance by medical professionals

Ergonomic excellence - The Wiha screwdriver handle size concept and Wiha Inomic® pliers handle concept. When you are the first hand tool manufacturer in the world to have products distinguished with the renowned AGR quality seal, it's a sensation. Very few everyday objects are able to pass the stringent tests of the AGR, whose seal enjoys broad acceptance by medical professionals for very good reason.

For years, the AGR have been dedicated to promoting and researching the prevention of back pain and they offer recommendations on products which help to prevent musculoskeletal disorders and back pain.





---

Wiha have now been officially recognised for their ergonomic screwdriver handle size concept and Inomic® pliers handle concept. To us, this distinction is confirmation of our philosophy: To develop tools enabling the professional to not only work efficiently, but also in a health-preserving way. Wiha's screwdriver handle size concept features four handle sizes and lengths, each optimally suited to its respective fastening or work task to ensure healthy work. The angled "pistol handle" of the Wiha Inomic® pliers handle concept relieves the user's wrist while working.

Both handle concepts help users to reduce, or even fully prevent, discomfort in their musculoskeletal system and pain in their joints and muscles. The result? With Wiha, your work is easier, you don't get fatigued as quickly, you work more efficiently and you simply feel better at the end of the working day. As our campaign logo motto goes: "I feel Wiha!"

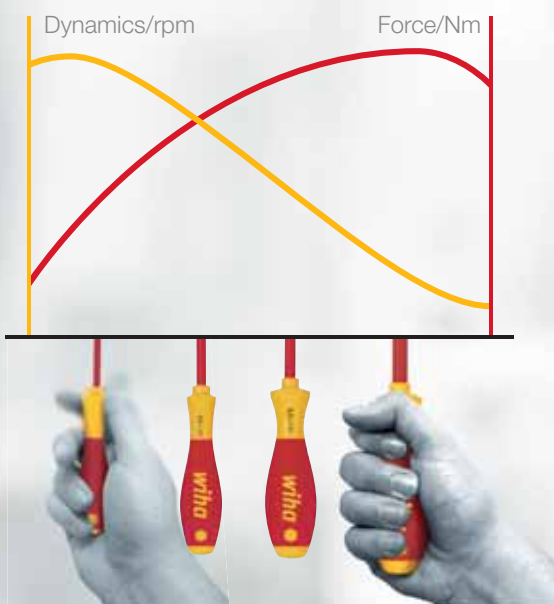

### Wiha SoftFinish® handle sizes

Every Wiha handle optimally balances guidance, speed and torque for the respective fastening task.

Quick-turning - Motor skills are consistently taken into consideration.

Maximum power transmission, comfortable to use and without loss.

# VDE-insulated tools from Wiha

## To work safer, more efficiently and with less strain on the body.

### Certified safety – from our own safety testing procedure according to IEC standards.

**Voltage testing:** All Wiha VDE-tools, which have special markings, are individually tested at 10,000 V AC and are approved for 1,000 V AC and 1,500 V DC.

**Cold shock test:** Cooling down to -25° C. The skinning material must retain its toughness, so that it doesn't break when subjected to shock and knocks.

**Test of electrical skinning properties:** 24 hours storage in water, then 3 minutes test at 10,000 V AC. There must neither be flashover nor disruptive discharge.

**Test of the adhesion of the skinning material coating:** 168 hours storage at 70° C, then test of adhesion at 500 N.

**Pressure tests:** Test at 20 N pressure load, 70° C temperature and 5,000 V AC test voltage. No disruptive discharge may occur.

**Test of combustion behaviour:** The tools are subjected to a flame for 10 seconds. The skinning material must then extinguish and not continue to burn.

### Safety note

The following equipment is required for all work on or around live components and should be appropriate for the specific task

- insulating personal protective equipment
- insulated tools
- insulating safety mechanisms

Before starting work, you must disconnect all active, live components of electrical machines and equipment and ensure that they remain disconnected while you carry out the work.

This is achieved by complying with the five safety rules:

- disconnect
- ensure power is switched off
- cover or block off adjacent live components
- secure against reconnection
- earth and short-circuit



---

As an internationally recognized institute, the VDE is responsible for the testing and certification of electrotechnical products. Wiha provides the professional with a broad range of VDE products, developed and continuously optimized specifically for electricians, which also provide application-oriented solutions for everyday use.

The Wiha quality-management system according to ISO 9001:2015 ensures that only first-class products are manufactured – and that you can work with products of excellent quality. To ensure maximum safety for the user, the entire Wiha VDE range must undergo the most stringent inspections and individual tests. All Wiha VDE-tools hold multiple certifications: The VDE-GSmark stands for safety with regard to any risk, from electrical right up to radiological. Products labelled with a double triangle and a voltage range are suitable for work with live parts.

The international standard IEC 60900 defines the construction, safety as well as single, series, and random testing of insulated tools. But with Wiha you don't just work safer, but also healthier and more efficiently. Specially developed ergonomic geometries ensure comfortable handling that protects the body from strain. The result: easier work, less signs of fatigue, more efficiency.



# 83 professionals. One system.

## ElectricVario family by Wiha.

There has never been a team with so many exceptional players: the ElectricVario Family by Wiha unites all fastening tools that electricians need for all the challenges in their job. These include many new members to complete the team. The best thing about them: Thanks to the countless combination possibilities, the tools can be used flexibly and thus save valuable time and space. Combinable with one another, the tools also ensure safe screw-fastening on live parts thanks to their insulation. The ergonomically shaped screwdriver handles also help to protect the user's muscles. Professional users play in the Premier League when they use ElectricVario Family products. They can always be identified via the ElectricVario Family logo.

- **Increases your efficiency**

Various usage options for all fastening procedures and application fields.

- **Offers you full protection**

Internationally award-winning VDE-insulated tools, each individually tested at 10,000 V AC and approved for use at 1,000 V AC.

- **Increases your safety**

Wiha slimBits ensure unrestricted and fully insulated access to low-lying screws.

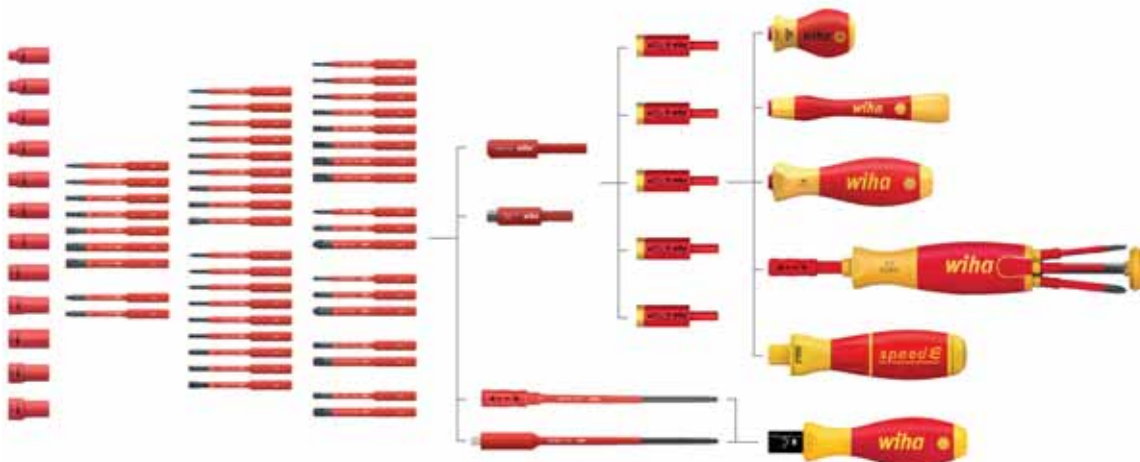



## Content

**Competence XXL II  
electrician's tool set**  
Page 138



**Tool set service technician**  
Page 142



**Tool set slimVario® electric**  
Page 143



**Tool set electrician**  
Page 143



**E-screwdriver, set 2, speedE®**  
Page 156



**speedE® Industrial  
e-screwdriver set**  
Page 159



**Flashlight with LED, laser and  
UV light**  
Page 160



**Single-pole, non-contact volt  
detector, 12–1,000 V AC**  
Page 160



**Screwdriver and bit set  
slimVario® screwdriver**  
Page 164



**slimBit electric bit set**  
Page 168



**Screwdriver SoftFinish® elec-  
tric slimFix**  
Page 172



**Screwdriver SoftFinish®**  
Page 178



**LiftUp 26one® skruetrækker  
med bitmagasin**  
Page 194



**Torque screwdriver  
TorqueVario®-S electric**  
Page 195



**Torque screwdriver with  
T-handle TorqueVario®-S T  
electric**  
Page 200



**Torque screwdriver iTorque®**  
Page 201



**Screwdriver with bit magazine  
LiftUp electric**  
Page 214



**Screwdriver with bit magazine,  
LiftUp 26one®**  
Page 214



**Multitool PocketStar**  
Page 217



**Nut driver insert set gripper,**  
Page 220



**L-key set in ErgoStar holder**  
Page 230



**L-key set in ProStar holder**  
Page 232



**L-key set in ProStar  
holdera**  
Page 232



**L-key set in ErgoStar holder**  
Page 235



**BitBuddy® TY bit set, 29 mm**  
Page 257



**XLSelector T bit set, 50 mm**  
Page 258



**TY bit set 29 mm**  
Page 258



**T bit set, 25 mm**  
Page 260



**Installation pliers TriCut  
Professional electric**  
Page 287



**Combination pliers  
Professional electric with  
DynamicJoint® and OptiGrip**  
Page 290



**Stripping tool automatic**  
Page 295



**Automatic crimp tool, for wire-  
end sleeves hex crimping**  
Page 298



**Soft-faced hammer set Safety**  
Page 328



**Soft-faced hammer Safety  
soft/medium hard**  
Page 329



**Soft-faced hammer dead-blow,  
medium hard**  
Page 332



**Electrician's hammer**  
Page 334



**Ratchet wrench set insulated 3/8"**  
Page 147



**Tool set mechanic**  
Page 151



**Tool set ESD**  
Page 153



**Ranges**  
From page 136

**Torque QuickCheck torque testing device**  
Page 161



**Electro**  
From page 154

**Fine screwdriver PicoFinish**  
Page 184



**Screwdriver MicroFinish®**  
Page 187



**Screwdriver SoftFinish® ESD**  
Page 189



**Screwdrivers**  
From page 162

**Torque screwdriver TorqueVario®-S**  
Page 202



**Torque screwdriver with T-handle TorqueVario®-S T**  
Page 206



**Torque screwdriver TorqueVario®-S ESD**  
Page 209



**Torque tools**  
From page 192

**Screwdriver with interchangeable blade set SYSTEM 6**  
Page 221



**Screwdriver with interchangeable blade set SYSTEM 6**  
Page 221



**Screwdriver with interchangeable blade set SYSTEM 4 ESD**  
Page 223



**Multitools**  
From page 212

**L-key set in ProStar holder**  
Page 237



**L-key with T-handle ComfortGrip**  
Page 247



**L-key with key handle**  
Page 251



**L-keys**  
From page 228

**Y bit set, 25 mm**  
Page 261



**Bit Professional 1/4"**  
Page 270



**Bit holder CentroFix Force mechanically lockable 1/4", magnetic**  
Page 280



**Bits**  
From page 254

**Professional BiCut® high-performance diagonal cutters with DynamicJoint®, Switchable**  
Page 301



**Pliers wrench Classic**  
Page 308



**Classic circlip pliers with MagicTips®, straight**  
Page 312



**Pliers**  
From page 284

**SoftFinish® dowel racket set with dowels**  
Page 334



**Electrician's spirit level 40 cm**  
Page 335



**Electrician's Longlife® folding ruler, 2 m metric, 10 segments**  
Page 336



**Impact tools / Measurement tools**  
From page 326

**Information**  
From page 338







**Meets your requirements:** Case: robust, large, stable and secure with lid brake. **Lowers your costs:** The correct torque protects material from damage and ensures no additional follow-up work. **Increases your safety:** Internationally award-winning VDE-insulated tools, each individually tested at 10,000 V AC and approved for use at 1,000 V AC. Gas-filled shock absorbers hold the lid in all positions and reduce the risk of injury when closing. **Protect your health:** Wiha pliers require less force and reduce pressure on wrists. Ergonomic handle design makes work easier and prevents occupational illnesses. Trolley with stable in-line rollers allow easy and stress-free transportation of tools to the work area. **Increases your efficiency:** A comprehensive tool assortment, always providing you with the right tool when it is needed. The design and function of the tool trays guarantee quick and easy access to tools. **Increases your flexibility:** Ample space for additional tools and lots of storage for small parts and machines.





**Meets your requirements:** Case: robust, large, stable and secure with lid brake.  
**Lowers your costs:** The correct torque protects material from damage and ensures no additional follow-up work. **Increases your safety:** Internationally award-winning VDE-insulated tools, each individually tested at 10,000 V AC and approved for use at 1,000 V AC. Gas-filled shock absorbers hold the lid in all positions and reduce the risk of injury when closing. **Protect your health:** Wiha pliers require less force and reduce pressure on wrists. Ergonomic handle design makes work easier and prevents occupational illnesses. Trolley with stable in-line rollers allow easy and stress-free transportation of tools to the work area. **Increases your efficiency:** A comprehensive tool assortment, always providing you with the right tool when it is needed. The design and function of the tool trays guarantee quick and easy access to tools. **Increases your flexibility:** Ample space for additional tools and lots of storage for small parts and machines.

**Competence XXL II electrician's tool set assorted in case 115-pcs.**

Order-No. 42069  
 More information: Page 138



Further information:

**The perfect complement:**



**E-screwdriver, set 2, speedE®**

Order-No. 41912  
 More information: Page 156



## VDE-certified tools

**Insulated tools are essential for all work on or around live components.**

Wiha VDE-tested tools are subject to stringent safety test procedures.

All tools with the special marking have been tested at 10,000 V AC and are therefore approved for use at 1,000 V AC and 1,500 V DC.

Certified by the VDE Testing and Certification Institute and individually tested according to the international standard IEC 60900.

The following equipment is required for all work on or around live components and should be appropriate for the specific task

- insulating personal protective equipment
- insulating safety mechanisms
- insulated tools

Before starting work, you must disconnect all active, live components of electrical machines and equipment and ensure that they remain disconnected while you carry out the work.

This is achieved by complying with the five safety rules:

- disconnect
- secure against reconnection
- ensure power is switched off
- earth and short-circuit
- cover or block off adjacent live components



**Meets your requirements:** Case: robust, large, stable and secure with lid brake.  
**Lowers your costs:** The right tool protects you from damaging materials and avoids subsequent work. **Increases your safety:** Internationally award-winning VDE-insulated tools, each individually tested at 10,000 V AC and approved for use at 1,000 V AC. Gas-filled shock absorbers hold the lid in all positions and reduce the risk of injury when closing. **Protect your health:** Wiha pliers require less force and reduce pressure on wrists. Ergonomic handle design makes work easier and prevents occupational illnesses. Carry belt enables the simple transport of the tool case and keeps hands free for other materials. **Increases your efficiency:** A comprehensive tool assortment, always having the right tool at hand when needed. The design and function of the tool trays guarantee quick and easy access to tools. **Increases your flexibility:** Ample space for additional tools and lots of storage for small parts and machines.

### Tool set electrician Competence XL assorted 80-pcs. in case

Order-No. 40523

More information: Page 140

### The perfect complement:



### Torque screwdriver set TorqueVario®-S electric

Order-No. 36791

More information: Page 194



**Simplifies your work:** All tools securely arranged in a robust, orderly bag. **Increases your safety:** Wiha slimBits ensure good, protected access to deep-set screws. **Increases your efficiency:** Space saved thanks to extensive interchangeable bit system and nut driver inserts. **Offers you full protection:** Each tool individually tested at 10,000 V AC and approved for 1,000 V AC. **Protects your material:** Fully insulated nut driver reduces the risk of short circuits.

**Tool set slimVario® electric mixed, 31-pcs. in functional bag**  
 Order-No. 43465  
 More information: Page 143





**Protect your health:** Recommended by doctors and therapists at Fixing by hand with a deft touch. **Offers you full protection:** slimBits **speed:** Work twice as fast thanks to three-step process. **Protects** prevent damage to materials (max. 0.4 Nm).



Focus Open 2018  
Special Mention



GERMAN  
DESIGN  
AWARD  
GOLD  
2019

German Campaign for Healthier Backs. **Increases your control:** tested at 10,000 V AC and approved for 1,000 V AC. **Increases your your material:** Electric screw fastening with protection function to



**Protect your health:** Recommended by doctors and therapists at German Campaign for Healthier Backs. **Increases your control:** Fixing by hand with a deft touch. **Offers you full protection:** slimBits tested at 10,000 V AC and approved for 1,000 V AC. **Increases your speed:** Work twice as fast thanks to three-step process. **Protects your material:** Electric screw fastening with protection function to prevent damage to materials (max. 0.4 Nm).

**E-screwdriver, set 3, speedE®**  
**Mixed 25 pcs in L Boxx Mini with slimBits, easyTorque adapters, batteries and EU charger**

Order-No. 41913  
 More information: Page 157



More information:

**The perfect complement:**



**Screwdriver with bit magazine LiftUp electric**

Order-No. 41234  
 More information: Page 214

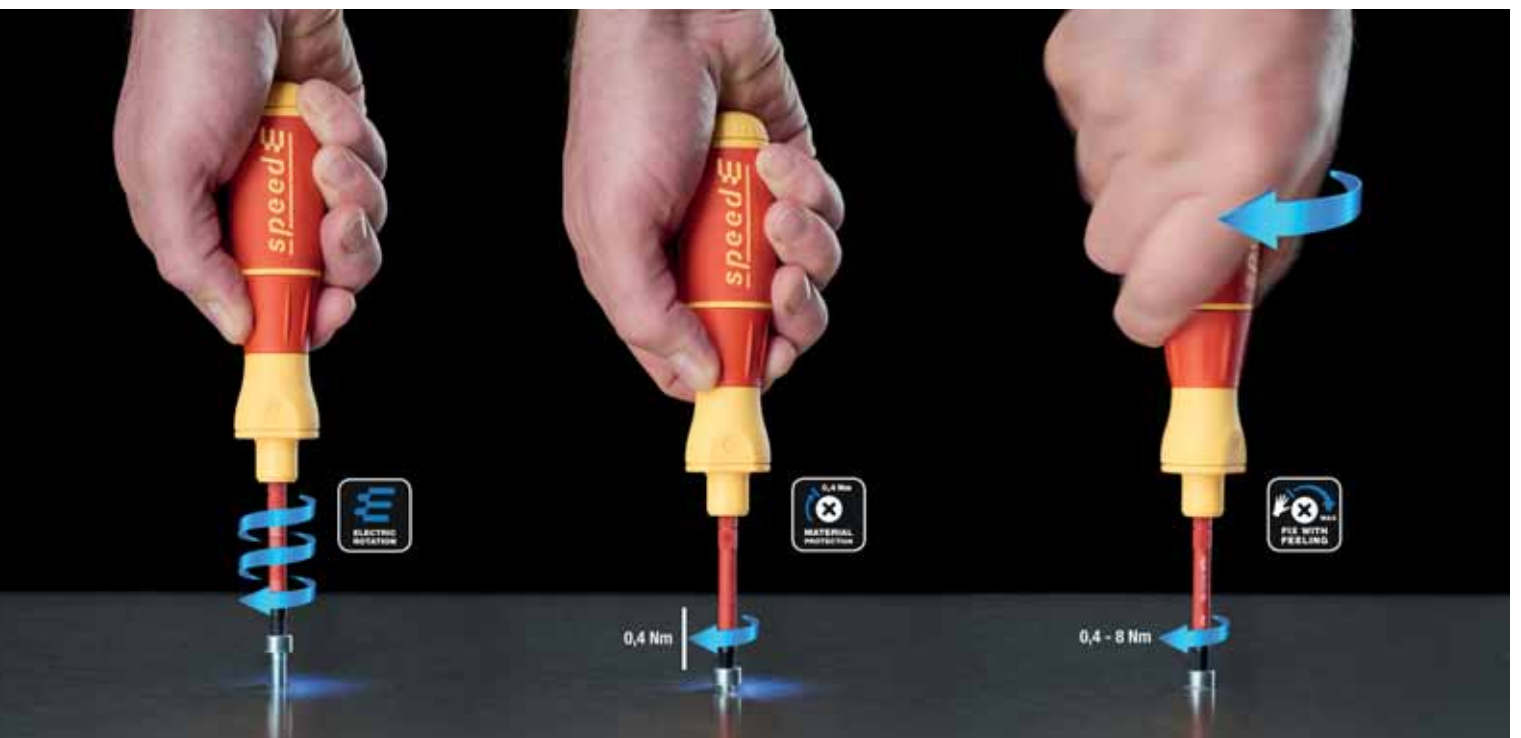





## Wiha speedE®

### E-screwdriver speedE®

#### **Increases your speed**

Power-assisted screw-driving halves working time.

#### **Protects your material**

Thanks to the integrated material protection function, the electric assistance stops automatically at 0.4 Nm.

#### **Increases your control**

Final screw tightening can then be carried out by hand.

Recommended by doctors and therapists.

slimBits tested at 10,000 V AC and approved for 1,000 V AC.





**Simplifies your work:** Retaining clip and magnetic positioner on the lid allows you to keep hands free for other tasks. Integrated laser makes it easier to fix position more precisely and project measurements for ceiling installations, for example. Perfect light positioning thanks to lamp head swivelling in an L shape. **Increases your safety:** Power-on time of 2 seconds prevents the laser being activated by accident. **Increases your efficiency:** Very strong LED lamp – two light intensities to adjust to light conditions as required. Includes laser and UV light.





**Simplifies your work:** Retaining clip and magnetic positioner on the lid allows you to keep hands free for other tasks. Integrated laser makes it easier to fix position more precisely and project measurements for ceiling installations, for example. Perfect light positioning thanks to lamp head swivelling in an L shape. **Increases your safety:** Power-on time of 2 seconds prevents the laser being activated by accident. **Increases your efficiency:** Very strong LED lamp – two light intensities to adjust to light conditions as required. Includes laser and UV light.

### Flashlight with LED, laser and UV light in blister pack, including 3 AAA batteries

Order-No. 41286

More information: Page 160



More information:

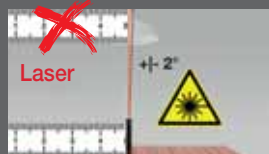

### Flashlight with LED, laser and UV light

Universal work tool with integrated laser, UV light and LED light.

Optimum positioning and variable light direction thanks to the magnetic base and swivel head.

The installation position can be projected directly from the middle of a table when fitting lights to the ceiling.

The integrated UV light is ideal for finding misplaced coloured fluorescent Wiha tools and for technical inspections.





**Increases your safety:** Checking your torque tool regularly guarantees safe, precise work with the correct torque. **Saves time:** LED traffic light system displays results in a way which is quick and easy to understand. **Increases your efficiency:** Fast, easy checking of your torque tool thanks to mobile, compact shape.





**Increases your safety:** Checking your torque tool regularly guarantees safe, precise work with the correct torque. **Saves time:** LED traffic light system displays results in a way which is quick and easy to understand. **Increases your efficiency:** Fast, easy checking of your torque tool thanks to mobile, compact shape.

**Torque QuickCheck torque testing device with adapter blades and batteries in box**

Order-No. 42086

More information: Page 161

More information:







## Wiha Torque QuickCheck

The Wiha torque screwdriver can quickly and easily test torque screwdrivers to check the precision of the configured torque value before each use.

Checking tools regularly ensures reliable, precise work.

The device offers user-friendly operation, clear test readings and easy to understand LED traffic light signals.

Thanks to a compact, handy shape, it is the ideal companion when out on jobs.

Suitable for all Torque Vario®-S and iTorque® torque screwdrivers whose torque range included 2.8 Nm.





**Simplifies your work:** All tools securely arranged in a robust, good, protected access to deep-set screws. **Increases your space.** **Offers you full protection:** Each tool individually tested



orderly bag. **Increases your safety:** Wiha slimBits ensure **efficiency:** Extensive interchangeable blade system saves you at 10,000 V AC and approved for 1,000 V AC.



**Simplifies your work:** All tools securely arranged in a robust, orderly bag. **Increases your safety:** Wiha slimBits ensure good, protected access to deep-set screws. **Increases your efficiency:** Extensive interchangeable blade system saves you space. **Offers you full protection:** Each tool individually tested at 10,000 V AC and approved for 1,000 V AC.

### Screwdriver and bit set slimVario® screwdriver

**Mixed, 18-pcs. in folding bag**

Order-No. 41231

More information: Page 164



Product video:

### The perfect complement:



### Screwdriver with bit holder set electric slimVario®

Order-No. 41230

More information: Page 167



**Saves time:** Rapid voltage test thanks to contactless measuring. **Increases your efficiency:** Compatible for use in all sockets worldwide thanks to measurement tip suited to international usage. Integrated high-luminescence LED flashlight. **Increases your flexibility:** Voltage tester covers a wide voltage range between 12 and 1,000 V AC.

**Single-pole, non-contact volt detector,  
12–1,000 V AC  
Includes two AAA batteries**

Order-No. 43797

More information: Page 174



## Volt Detector

**Single-pole, non-contact volt detector,  
12–1,000 V AC**

Rapid voltage test thanks to contactless measuring.

Compatible for use in all sockets worldwide thanks to measurement tip suited to international usage.

Voltage tester covers a wide voltage range between 12 and 1,000 V AC.



**Increases your safety:** Wiha slim blades ensure unlimited, the patented SoftFinish® handle design, ensuring work is kind to German Campaign for Healthier Backs. **Increases your efficiency:** and control. **Offers you full protection:** Each tool individually



protected access to deep-set screws. **Protect your health:** With hands and muscles. Recommended by doctors and therapists at Unique Wiha handle-length concept for optimum balance of torque tested at 10,000 V AC and approved for 1,000 V AC.

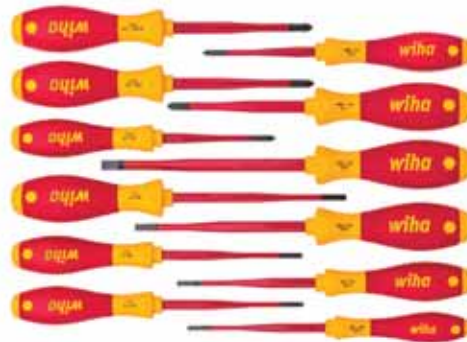

**Increases your safety:** Wiha slim blades ensure unlimited, protected access to deep-set screws. **Protect your health:** With the patented SoftFinish® handle design, ensuring work is kind to hands and muscles. Recommended by doctors and therapists at German Campaign for Healthier Backs. **Increases your efficiency:** Unique Wiha handle-length concept for optimum balance of torque and control. **Offers you full protection:** Each tool individually tested at 10,000 V AC and approved for 1,000 V AC.

### Screwdriver set SoftFinish® electric slimFix assorted 12-pcs.

Order-No. 41003

More information: Page 165



Product video:

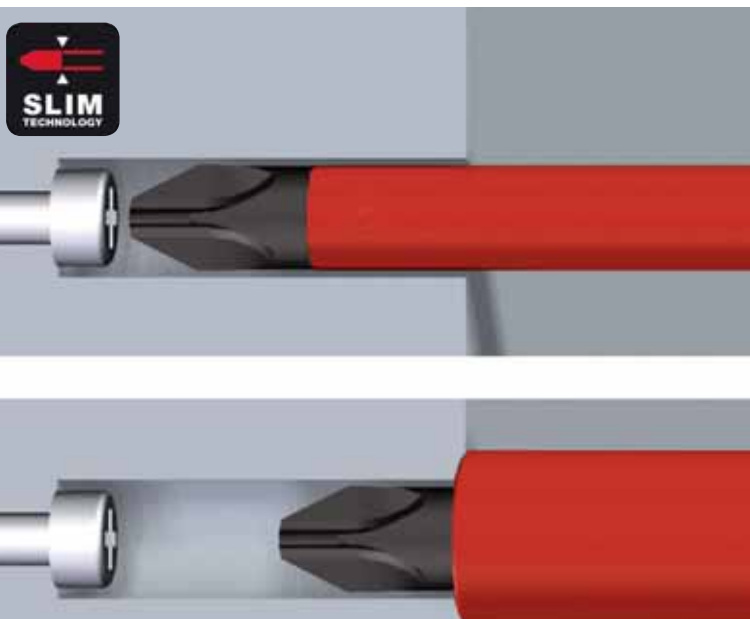

## slimTECHNOLOGY

### Wiha SoftFinish® electric slimFix

Unlimited access.

Blades up to 33 % narrower due to integrated insulation.

Tool for spring clips (wedge-profiled output geometry).





**Increases your safety:** Wiha slim blades ensure unlimited, protected access to deep-set screws. **Protect your health:** With the patented SoftFinish® handle design, ensuring work is kind to hands and muscles. Recommended by doctors and therapists at German Campaign for Healthier Backs. **Increases your efficiency:** Unique Wiha handle-length concept for optimum balance of torque and control. **Offers you full protection:** Each tool individually tested at 10,000 V AC and approved for 1,000 V AC.

**Screwdriver set SoftFinish®  
electric slimFix  
Slotted, Phillips, PlusMinus/  
Pozidriv 6-pcs.**

Order-No. 38362

More information: Page 166



Product video:

**The perfect complement:**



**Pliers set Professional electric**

Order-No. 26852

More information: Page 286

**Wiha SoftFinish® handle sizes**

Every Wiha handle optimally balances guidance, speed and torque for the respective fastening task.

Quick-turning - Motor skills are consistently taken into consideration.

Maximum power transmission: comfortable and loss-free transmission of physical strength, even during intensive fastening.

The power-turning and quick-turning zones vary significantly over the four handle sizes in various forms.

The Wiha SoftFinish screwdrivers enable work that is kind on the hands and muscles and is therefore recommended by doctors and therapists from the AGR.





**Simplifies your work:** Compact handle – maximum power. **Increases your safety:** Wiha slimBits ensure good, protected access to deep-set screws. Protected work in constricted spaces. **Increases your efficiency:** Fully compatible with the Wiha slimBit system. **Offers you full protection:** Each tool individually tested at 10,000 V AC and approved for 1,000 V AC.

### Screwdriver with bit holder set electric slimVario®

#### Stubby, 4 pieces with slimBits

Order-No. 41230

More information: Page 167



Product video:

### The perfect complement:



### Screwdriver with bit magazine LiftUp electric

Order-No. 41234

More information: Page 214

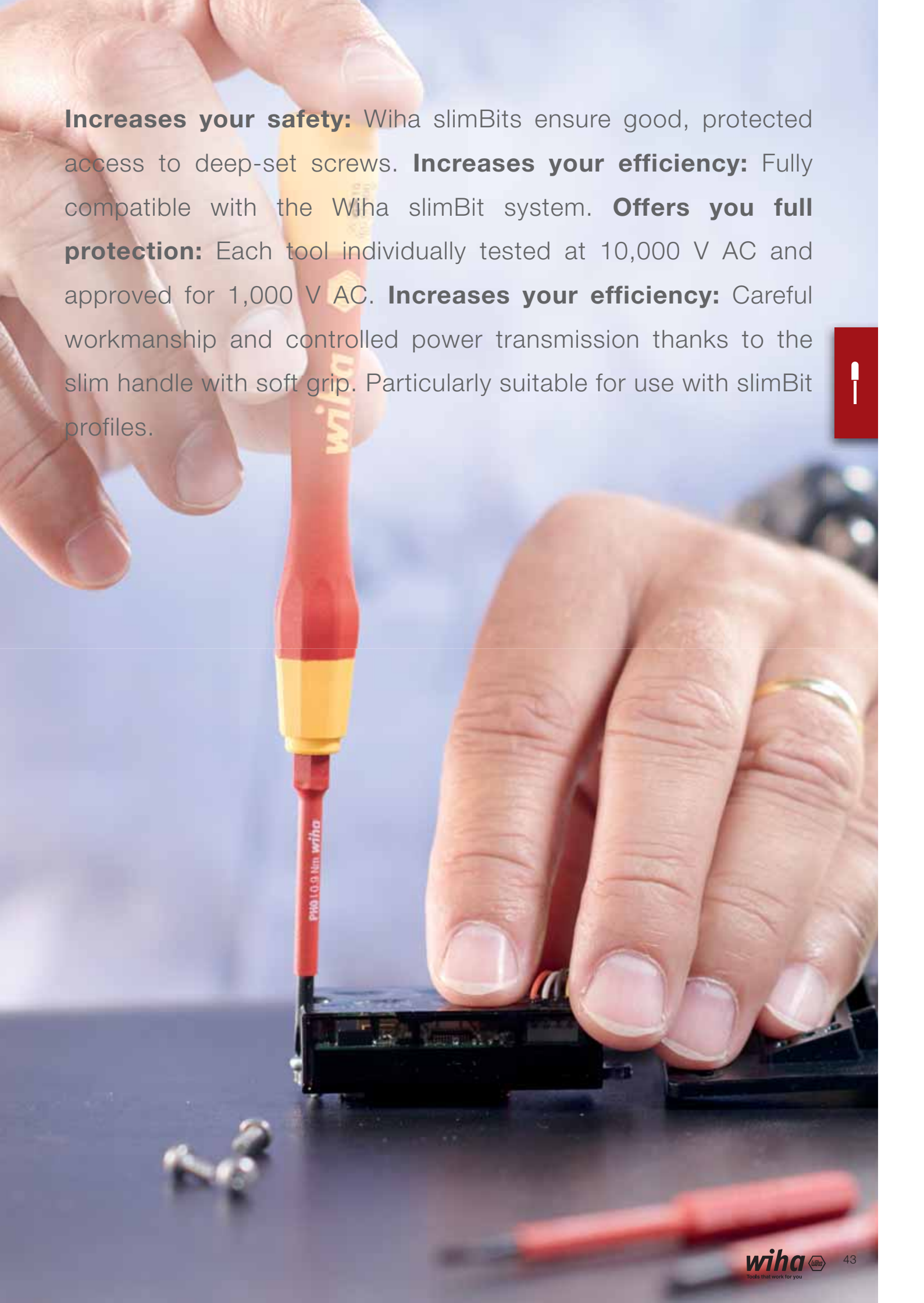

**Increases your safety:** Wiha slimBits ensure good, protected access to deep-set screws. **Increases your efficiency:** Fully compatible with the Wiha slimBit system. **Offers you full protection:** Each tool individually tested at 10,000 V AC and approved for 1,000 V AC. **Increases your efficiency:** Careful workmanship and controlled power transmission thanks to the slim handle with soft grip. Particularly suitable for use with slimBit profiles.





**Increases your safety:** Wiha slimBits ensure good, protected access to deep-set screws. **Increases your efficiency:** Fully compatible with the Wiha slimBit system. **Offers you full protection:** Each tool individually tested at 10,000 V AC and approved for 1,000 V AC. **Increases your efficiency:** Careful workmanship and controlled power transmission thanks to the slim handle with soft grip. Particularly suitable for use with slimBit profiles.

**Fine screwdriver set PicoFinish®  
slimVario® electric**

**4-pcs. with slimBits**

Order-No. 43167

More information: Page 167



**Combination profiles**

**PlusMinus.**

The special PlusMinus/Pozidriv profile is ideal for PlusMinus terminal screws.

The combination profile reduces slipping out and guarantees a higher torque transmission.



**Simplifies your work:** Sensitive working due to slim handle and rotating cap. With a practical plastic holder to hang up or stand on a surface. **Increases your efficiency:** Screwdriver handle size concept for optimal balance between precision and control. **Offers you full protection:** Each tool individually tested at 10,000 V AC and approved for 1,000 V AC.

**Fine screwdriver set PicoFinish electric  
Slotted, Phillips, 6 pcs. with holder**

Order-No. 42989  
More information: Page 168



Product video:

**The perfect complement:**



**Screwdriver with interchangeable  
blade set SYSTEM 4**

Order-No. 00610  
More information: Page 225



**PicoFinish electric**

**Wiha PicoFinish electric: The  
VDE-GS tested precision  
screwdriver.**

The smooth-running turn-cap enables fast turning.

Imprint with the screw symbol and sizes eases recognition.

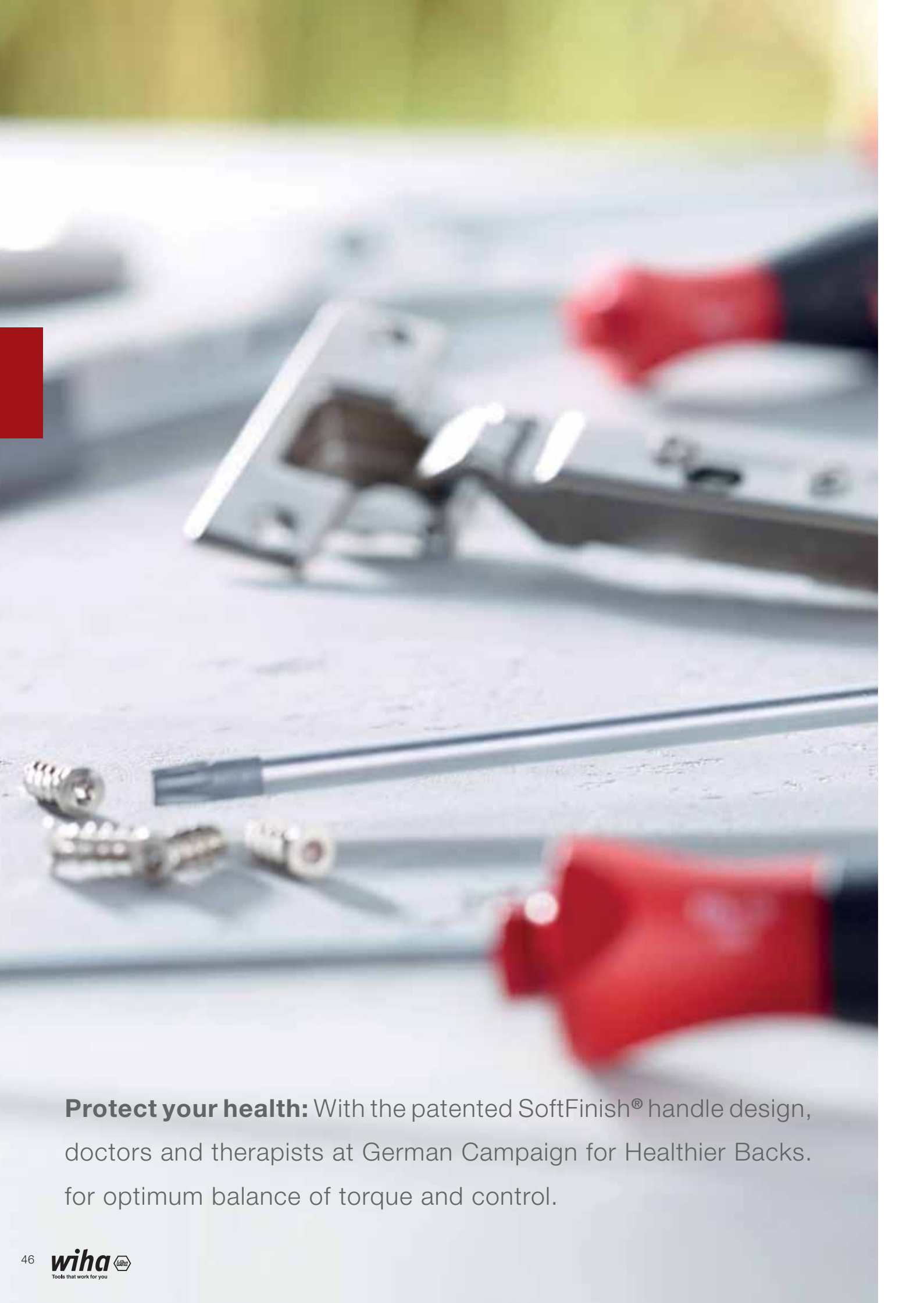

**Protect your health:** With the patented SoftFinish® handle design, doctors and therapists at German Campaign for Healthier Backs. for optimum balance of torque and control.



ensuring work is kind to hands and muscles. Recommended by  
**Increases your efficiency:** Unique Wiha handle-length concept



**Protect your health:** With the patented SoftFinish® handle design, ensuring work is kind to hands and muscles. Recommended by doctors and therapists at German Campaign for Healthier Backs. **Increases your efficiency:** Unique Wiha handle-length concept for optimum balance of torque and control.

### Screwdriver set SoftFinish® assorted 12-pcs.

Order-No. 41002

More information: Page 175



Product video:

### The perfect complement:



### Magnetiser

Order-No. 01508

More information: Page 186

### Wiha SoftFinish® screwdriver

The convenient expert for dry applications.

The SoftFinish handle provides optimal grip for dry applications in trade and industry.

The position of the soft and hard zones on the handle also supports the perfect grip for quick and powerful turning.





**Increases your safety:** Wiha slimBits ensure good, protected access to deep-set screws. **Makes handling easier:** Compact slimBit box with easy access and an optimal view of profiles. Convenient safe storage of 12 slimBits – easily taken directly from the belt. **Offers you full protection:** Each tool individually tested at 10,000 V AC and approved for 1,000 V AC.

**slimBit electric bit set  
TORX®, TORX PLUS®, 12-pcs.  
in SlimBit box**

Order-No. 43161

More information: Page 198





**Increases your safety:** Wiha slimBits ensure good, protected access to deep-set screws. **Makes handling easier:** Compact slimBit box with easy access and an optimal view of profiles. Convenient safe storage of 12 slimBits – easily taken directly from the belt. **Offers you full protection:** Each tool individually tested at 10,000 V AC and approved for 1,000 V AC.





**Meets your requirements:** Standard drives and dimensions neatly stored away in a kit.  
**Protect your health:** With the patented SoftFinish® handle design, ensuring work is kind to hands and muscles. Recommended by doctors and therapists at German Campaign for Healthier Backs.  
**Increases your efficiency:** Unique Wiha handle-length concept for optimum balance of torque and control.

### Screwdriver set SoftFinish® Slotted, Phillips 6-pcs.

Order-No. 07152

More information: Page 175



Product video:

### The perfect complement:



### Magnetiser

Order-No. 01508

More information: Page 186



**Simplifies your work:** Striking cap integrated into the handle allows you to strike and lift with the screwdriver. **Makes handling easier:** Easy loosening of tight screws thanks to hex bolster for spanners. **Protect your health:** With the patented SoftFinish® handle design, ensuring work is kind to hands and muscles. Recommended by doctors and therapists at German Campaign for Healthier Backs. **Increases your efficiency:** Unique Wiha handle-length concept for optimum balance of torque and control.

**Screwdriver set SoftFinish®  
Slotted, Phillips hexagonal blade and  
solid steel cap, 6-pcs.**

Order-No. 21250

More information: Page 176



Product video:

**The perfect complement:**



**Electrician's hammer**

Order-No. 42071

More information: Page 334

**Solid steel cap and hexagon  
head**

The solid steel cap at the end of the screwdriver handle enables targeted hammering, e.g. to loosen jammed screws.

The direct connection of the solid steel cap to the blade means that the impact energy is transmitted without any loss.

Blade includes a hexagon bolster for using a set of spanners for additional torque.



**Simplifies your work:** Striking cap integrated into the handle allows you to strike and lift with the screwdriver. **Increases your safety:** Anti-slip handle simplifies work in oily and wet application areas. **Makes handling easier:** Easy loosening of tight screws thanks to hex bolster for spanners. **Protect your health:** With the patented SoftFinish® handle design, ensuring work is kind to hands and muscles. Recommended by doctors and therapists at German Campaign for Healthier Backs. **Increases your efficiency:** Unique Wiha handle-length concept for optimum balance of torque and control.

**Screwdriver set MicroFinish®**  
**Slotted, Phillips with one-piece hexagonal blade and solid steel cap,**  
**5-pcs.**

Order-No. 29138

More information: Page 187



Product video:

**The perfect complement:**



**Pliers set Professional**

Order-No. 26854

More information: Page 300

## Wiha MicroFinish screwdriver

The specialist for wet and oily applications.

Due to the micro-fine surface structure of the screwdriver handle, the user can gain an optimal hold, even with oily or wet hands.

The position of the soft and hard zones on the handle also supports the perfect grip for quick and powerful turning.





**Lowers your costs:** Electrostatically conductive tools protect electronic components from damage. **Protect your health:** With the patented SoftFinish® handle design, ensuring work is kind to hands and muscles. Recommended by doctors and therapists at German Campaign for Healthier Backs. **Increases your efficiency:** Screwdriver handle size concept for optimal balance between precision and control.

### Screwdriver set SoftFinish® ESD Slotted, Phillips 5-pcs.

Order-No. 27252

More information: Page 188



Product video:

### The perfect complement:



### Pliers set Professional ESD

Order-No. 33507

More information: Page 316



### PicoFinish

#### Wiha PicoFinish precision screwdriver

The comfortable precision screwdriver for fine and delicate fastenings.

The smooth-running turn-cap enables fast turning.

Imprint with the screw symbol and sizes eases recognition.



**Simplifies your work:** With a practical plastic holder to hang up or stand on a surface.  
**Lowers your costs:** Electrostatically conductive tools protect electronic components from damage.  
**Makes handling easier:** Extra-long rotating cap ensures optimum feed.  
**Increases your efficiency:** Screwdriver handle size concept for optimal balance between precision and control. Careful workmanship and controlled power transmission thanks to the slim handle with soft grip.

**Fine screwdriver set PicoFinish® ESD  
 Slotted, Phillips, 6 pcs. with holder**

Order-No. 43707

More information: Page 189



**Electrostatic conductive ESD tools**

Sensitive, electronic components can be damaged even at a very low voltage.

Dissipative tools by Wiha discharge the electrostatic energy in a controlled, safe manner.

ESD tools meet the ESD Standard IEC 61340-5-1.

ESD tool handles have a surface resistance of  $10^6$  -  $10^9$  Ohm.





**Meets your requirements:** A variably settable torque covers a large application area. **Simplifies your work:** All tools securely arranged in a robust, orderly bag. **Lowers your costs:** The correct torque protects you from warranty claims. **Increases your safety:** Wiha slimBits ensure good, protected access to deep-set screws. **Protect your health:** With the patented SoftFinish® handle design, ensuring work is kind to hands and muscles. Recommended by doctors and therapists at German Campaign for Healthier Backs. **Increases your efficiency:** The correct torque avoids damaging material and no follow-up work is necessary. **Offers you full protection:** Each tool individually tested at 10,000 V AC and approved for 1,000 V AC.

## Torque screwdriver set TorqueVario®-S electric

**Mixed, variably adjustable torque limit, 18 pcs. in folding bag**

Order-No. 36791

More information: Page 194



## slimTECHNOLOGY

### Wiha SoftFinish® electric slimFix

Unlimited access.

Blades up to 33 % narrower due to integrated insulation.

Tool for spring clips (wedge-profiled output geometry).



**Meets your requirements:** A variably settable torque covers a arranged in a robust, orderly bag. **Lowers your costs:** The correct Wiha slimBits ensure good, protected access to deep-set screws. ensuring work is kind to hands and muscles. Recommended by **Increases your efficiency:** The correct torque avoids damaging **protection:** Each tool individually tested at 10,000 V AC and



large application area. **Simplifies your work:** All tools securely torque protects you from warranty claims. **Increases your safety:** **Protect your health:** With the patented SoftFinish® handle design, doctors and therapists at German Campaign for Healthier Backs. material and no follow-up work is necessary. **Offers you full** approved for 1,000 V AC.



**Meets your requirements:** A variably settable torque covers a large application area. **Lowers your costs:** The correct torque protects you from warranty claims. **Makes handling easier:** Effortless and comfortable transmission of high torques thanks to T-handle with ComfortGrip. **Increases your efficiency:** The correct torque avoids damaging material and no follow-up work is necessary. **Offers you full protection:** Torque blades tested at 10,000 V AC and approved for 1,000 V AC.

**Torque screwdriver with T-handle  
TorqueVario®-S T electric  
Variable torque limit settings**

Order-No. 43177

More information: Page 200



**Meets your requirements:** A variably settable torque covers a large application area. **Lowers your costs:** The correct torque protects you from warranty claims. **Makes handling easier:** Effortless and comfortable transmission of high torques thanks to T-handle with ComfortGrip. **Increases your efficiency:** The correct torque avoids damaging material and no follow-up work is necessary. **Offers you full protection:** Torque blades tested at 10,000 V AC and approved for 1,000 V AC.





**Meets your requirements:** A variably settable torque covers a protects you from warranty claims. **Increases your efficiency:** work is necessary. **Increases your productivity:** Utmost process calibration alarm.



large application area. **Lowers your costs:** The correct torque  
The correct torque avoids damaging material and no follow-up  
safety thanks to integrated ClickControl counting function and



**Meets your requirements:** A variably settable torque covers a large application area. **Lowers your costs:** The correct torque protects you from warranty claims. **Increases your efficiency:** The correct torque avoids damaging material and no follow-up work is necessary. **Increases your productivity:** Utmost process safety thanks to integrated ClickControl counting function and calibration alarm.

### Torque screwdriver iTorque® with digital scale

Order-No. 36886

More information: Page 201



Product video:

### The perfect complement:



### L-key set in ErgoStar holder

Order-No. 37351

More information: Page 231

## iTorque

### The intelligent torque tool.

Required torque can be adjusted and set on the handle without the need for a separate tool.

Large numerical display simplifies reading.

ClickControl records every use and optimises the monitoring of measuring instruments.

Calibration alarm after 5,000 applications for absolute process safety.

Certified individual item testing directly after on-site production.

Broad selection of interchangeable blades and adapter blades.

Units can be switched (Nm » in.lb/ cNm » in.oz)

Can be recalibrated





**Meets your requirements:** A variably settable torque covers a large application area. **Simplifies your work:** All tools securely arranged in a robust and clearly laid out box. **Lowers your costs:** The correct torque protects you from warranty claims. **Protect your health:** With the patented SoftFinish® handle design, ensuring work is kind to hands and muscles. Recommended by doctors and therapists at German Campaign for Healthier Backs. **Increases your efficiency:** The correct torque avoids damaging material and no follow-up work is necessary.



**Torque screwdriver set TorqueVario®-S mixed, 13 pcs., variably adjustable torque limit, 0.8–5.0 Nm in box**

Order-No. 26893

More information: Page 202



Product video:

**The perfect complement:**



**Torque QuickCheck torque testing device**

Order-No. 42086

More information: Page 161





**Meets your requirements:** A variably settable torque covers a large application area. **Simplifies your work:** All tools securely arranged in a robust, orderly bag. **Lowers your costs:** The correct torque protects you from warranty claims. **Makes handling easier:** Effortless and comfortable transmission of high torques thanks to T-handle with ComfortGrip. **Increases your efficiency:** The correct torque avoids damaging material and no follow-up work is necessary.

**Torque screwdriver with T-handle set TorqueVario®-S T mixed, 11 pcs., variably adjustable torque limit, 5–14 Nm in box**

Order-No. 29234

More information: Page 206

**The perfect complement:**



**XLSelector T bit set, 25 mm**

Order-No. 41830

More information: Page 258

**TorqueVario®-S**

**Variably settable torque tools.**

For controlled fastening in a large range of applications.

Torque value is continuously adjustable thanks to the torque setter adjusting tool.

Distinctly audible and perceptible click signal when set torque is reached.

Each Wiha screwdriver handle provides a perfectly correlated ratio of guidance, speed and torque for any fastening task.

Certified individual item testing directly after on-site production.

Broad selection of interchangeable blades and adapter blades.





**Meets your requirements:** A variably settable torque covers a large application area. **Simplifies your work:** All tools securely arranged in a robust, orderly bag. **Lowers your costs:** Electrostatically conductive tools protect electronic components from damage. **Protect your health:** With the patented SoftFinish® handle design, ensuring work is kind to hands and muscles. Recommended by doctors and therapists at German Campaign for Healthier Backs. **Increases your efficiency:** The correct torque avoids damaging material and no follow-up work is necessary.

### Torque screwdriver set TorqueVario®-S ESD

**mixed, 13 pcs., variably adjustable torque limit, 0,4-1,0 Nm in box**

Order-No. 43898

More information: Page 209

### The perfect complement:



### Pliers set Professional ESD

Order-No. 33507

More information: Page 316

### Electrostatic conductive ESD tools

Sensitive, electronic components can be damaged even at a very low voltage.

Dissipative tools by Wiha discharge the electrostatic energy in a controlled, safe manner.

ESD tools meet the ESD Standard IEC 61340-5-1.

ESD tool handles have a surface resistance of  $10^6$  -  $10^9$  Ohm.

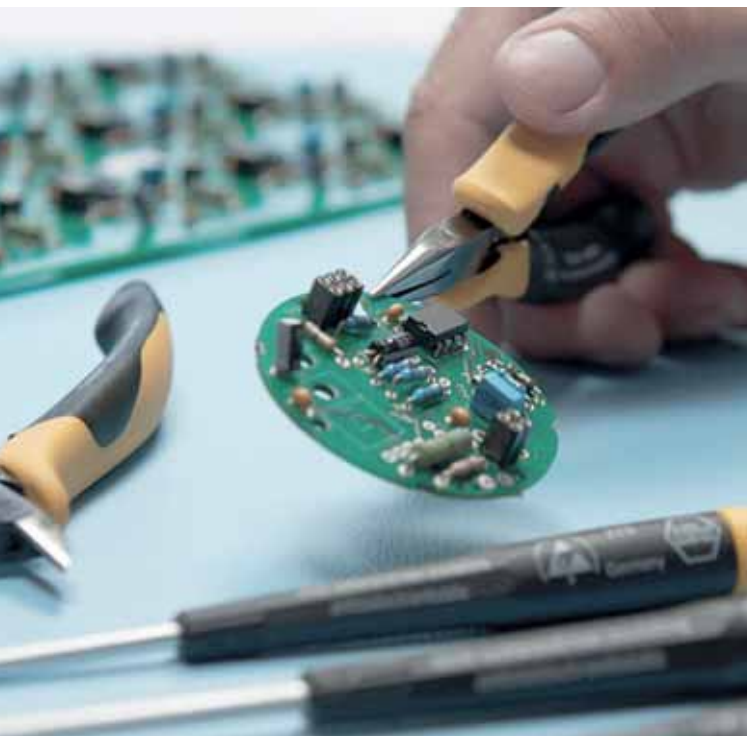

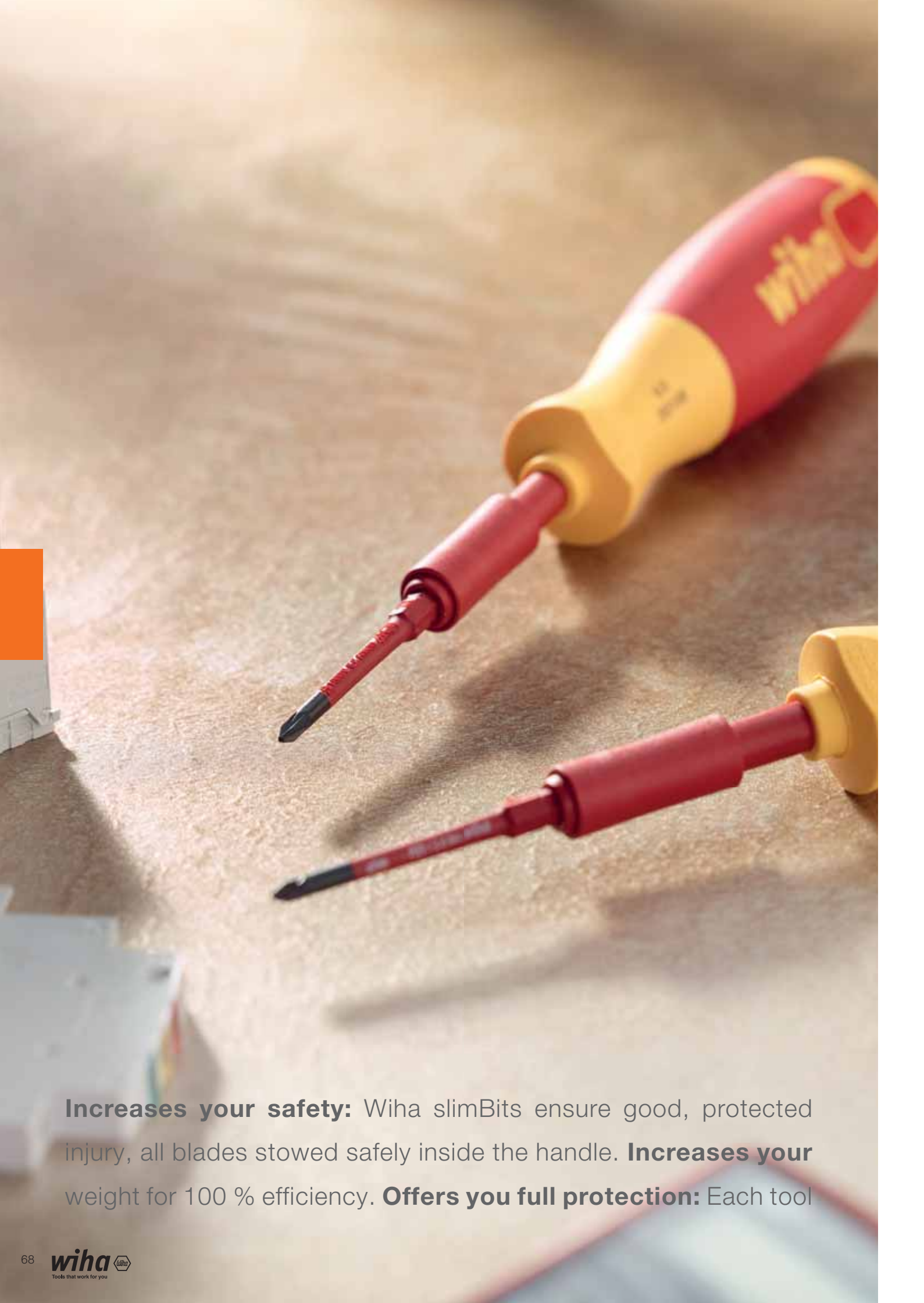

**Increases your safety:** Wiha slimBits ensure good, protected injury, all blades stowed safely inside the handle. **Increases your weight for 100 % efficiency.** **Offers you full protection:** Each tool



access to deep-set screws. **Protect your health:** No risk of  
**efficiency:** Wiha LiftUp electric saves 75% volume and 50% less  
individually tested at 10,000 V AC and approved for 1,000 V AC.



**Increases your safety:** Wiha slimBits ensure good, protected access to deep-set screws. **Protect your health:** No risk of injury, all blades stowed safely inside the handle. **Increases your efficiency:** Wiha LiftUp electric saves 75% volume and 50% less weight for 100 % efficiency. **Offers you full protection:** Each tool individually tested at 10,000 V AC and approved for 1,000 V AC.

### Screwdriver with bit magazine LiftUp electric

**Pozidriv, PlusMinus/Pozidriv, slotted with 6 slimBits**

Order-No. 41234

More information: Page 214



Product video:



### slimTECHNOLOGY

#### Wiha SoftFinish® electric slimFix

Unlimited access.

Blades up to 33 % narrower due to integrated insulation.

Tool for spring clips (wedge-profiled output geometry).



**Simplifies your work:** Larger handle – maximum power. **Lowers your costs:** 26 tools in one. **Saves time:** Searching? Never again - the most common bits in one tool. **Increases your efficiency:** 90% less volume, 85% less weight - 100% efficiency!

**Screwdriver with bit magazine, LiftUp 26one®**  
**Mixed with 13 double bits in blister pack**  
**1/4"**

Order-No. 43895

More information: Page 214



Product video:

**The perfect complement:**



**Professional BiCut® high-performance diagonal cutters with DynamicJoint®**

Order-No. 38190

More information: Page 301



**Simplifies your work:** Larger handle – maximum power. **Lowers**  
- the most common bits in one tool. **Increases your efficiency:**





**your costs:** 26 tools in one. **Saves time:** Searching? Never again  
90% less volume, 85% less weight - 100% efficiency!

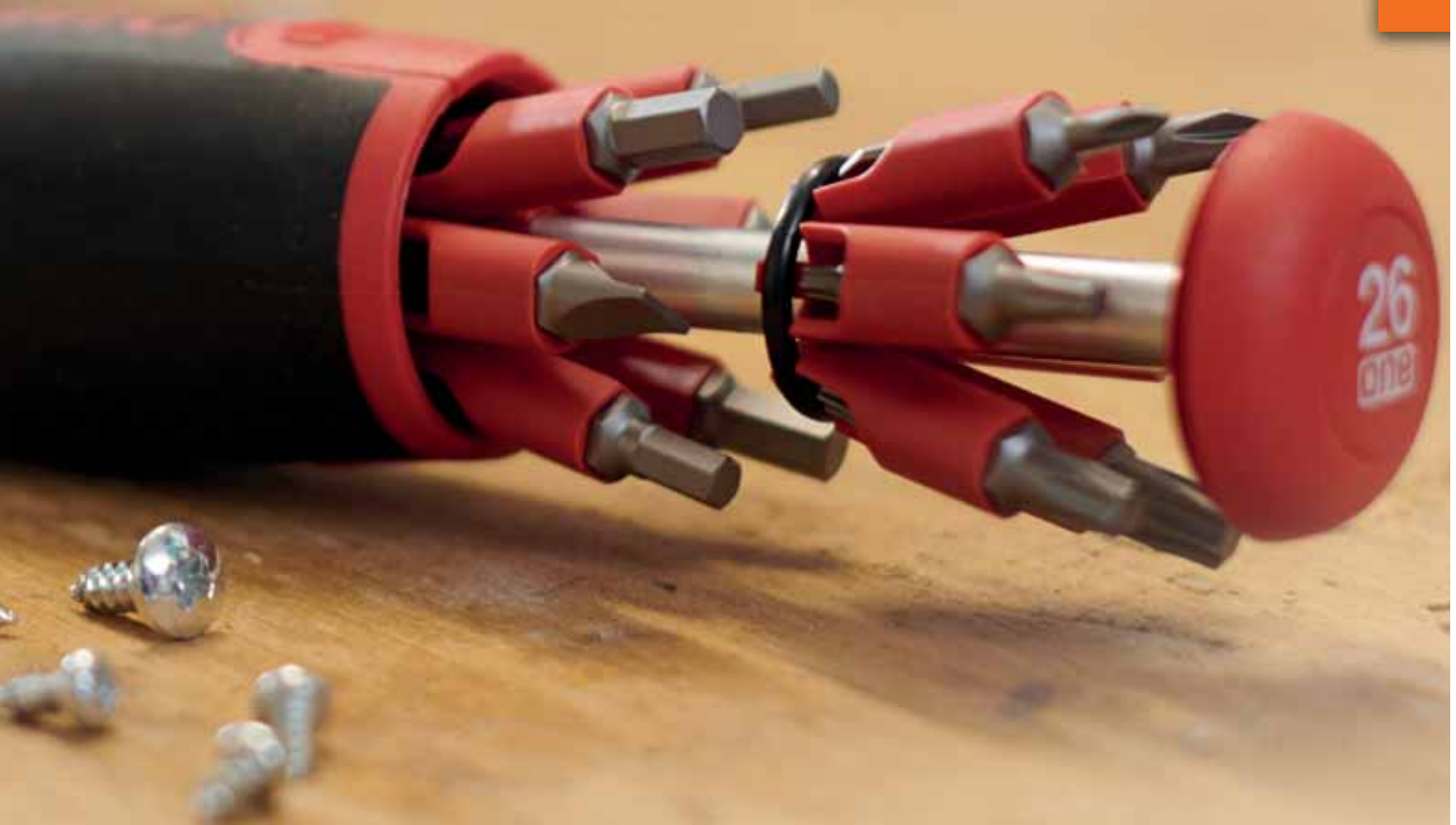



**Saves space:** Six tools in one. **Increases your efficiency:** Good access to confined spaces due to extremely short screwdriver handle.

**Screwdriver with bit magazine magnetic**

**Slotted, Phillips with 6 bits, Stubby, 1/4"**

Order-No. 33736

More information: Page 216



Product video:

**The perfect complement:**



**Screwdriver with bit holder set electric slimVario®**

Order-No. 41230

More information: Page 167





**Simplifies your work:** The variable handle position guarantees power fastenings as well as fast fastenings. **Saves time:** Thanks to its simple operation, the desired drive can be used quickly. **Increases your efficiency:** The most common drives cleverly organized in one tool.

**Multitool PocketStar  
assorted 9-pcs.**

Order-No. 25293

More information: Page 217



Product video:

**The perfect complement:**



**L-key set in ErgoStar holder**

Order-No. 37351

More information: Page 231



**PocketStar**

**The Multitool that fits in your pocket**

Simple and easy selection of the desired key size at the touch of a button.

Can be used as a screwdriver long handle and T-handle.

270° limit for safe work prevents trapped fingers.

Covered ends on both pivot axes prevent clothing from being caught.



**Saves space:** The gripper is the ideal space- and weight-saving alternative to a nut driver insert in mobile use. **Increases your efficiency:** The multifunctional gripper adapts to fit every bolt or screw with outer profile.

**Nut driver insert gripper  
3/8" in blister pack**

Order-No. 20554

More information: Page 220



Product video:

**The perfect complement:**



**Pliers set Professional**

Order-No. 26854

More information: Page 300





**Simplifies your work:** Blade length is adjustable from 42-114 mm. **Makes handling easier:** Easy operation of the locking and unlocking button. **Protect your health:** With the patented SoftFinish® handle design, ensuring work is kind to hands and muscles. Recommended by doctors and therapists at German Campaign for Healthier Backs. **Increases your efficiency:** Compact fastening tool System 6 with comprehensive, interchangeable blade selection.

**Screwdriver with interchangeable blade set SYSTEM 6**  
**Mixed 11-pcs. in roll-up bag**  
 Order-No. 03591  
 More information: Page 221



Product video:

**The perfect complement:**



**Screwdriver with interchangeable blade set SYSTEM 6**

Order-No. 27713

More information: Page 222



## SYSTEM 6

### Screwdriver with interchangeable blades

Flexible, versatile interchangeable blade system in industrial quality.

Suitable for all applications: the blades can be quickly combined, extended and exchanged.

Press sleeve: Blade lock is released

Desired blade length can be set (42 – 114 mm)

Release sleeve: Blade is held in place



**Simplifies your work:** Blade length is adjustable from 18-90 mm. **Lowers your costs:** Electrostatically conductive tools protect electronic components from damage. **Makes handling easier:** Easy operation of the locking and unlocking button. **Protect your health:** With the patented SoftFinish® handle design, ensuring work is kind to hands and muscles. Recommended by doctors and therapists at German Campaign for Healthier Backs. **Increases your efficiency:** Compact precision fastening tool System 4 with comprehensive, interchangeable blade selection.

### Screwdriver with interchangeable blade set SYSTEM 4 ESD

Mixed 11-pcs. in roll-up bag

Order-No. 31499

More information: Page 227

### The perfect complement:



### Pliers set Professional ESD

Order-No. 33507

More information: Page 316

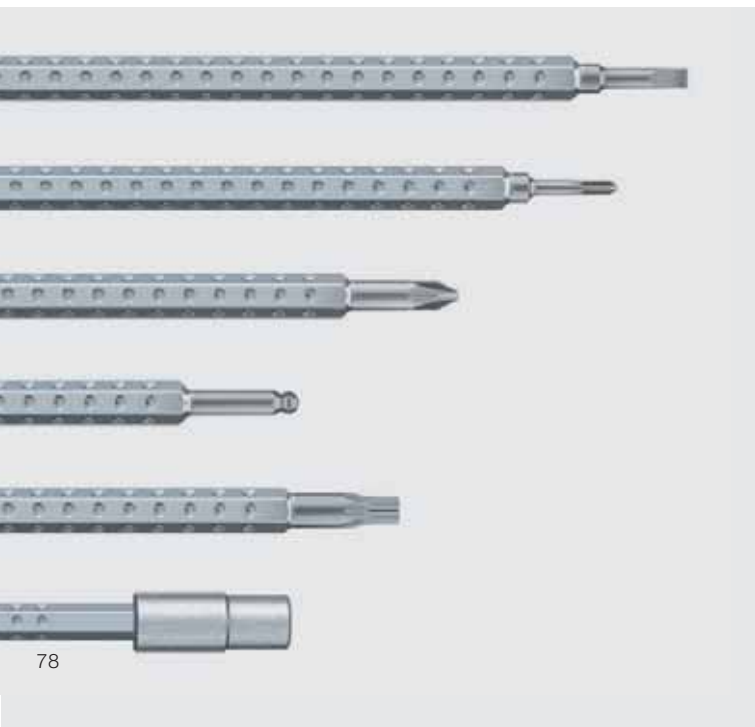

## SYSTEM 4

### Screwdriver with interchangeable blades

Flexible, versatile precision interchangeable blade system for delicate fastening tasks.

Suitable for all applications: the blades can be quickly combined, extended and exchanged.

Press sleeve: Blade lock is released

Press and hold sleeve: Desired blade length can be set (18 – 90 mm)

Release sleeve: Blade is held in place



## Electrostatic conductive ESD tools

Sensitive, electronic components can be damaged even at a very low voltage.

Dissipative tools by Wiha discharge the electrostatic energy in a controlled, safe manner.

ESD tools meet the ESD Standard IEC 61340-5-1.

ESD tool handles have a surface resistance of  $10^6$  -  $10^9$  Ohm.

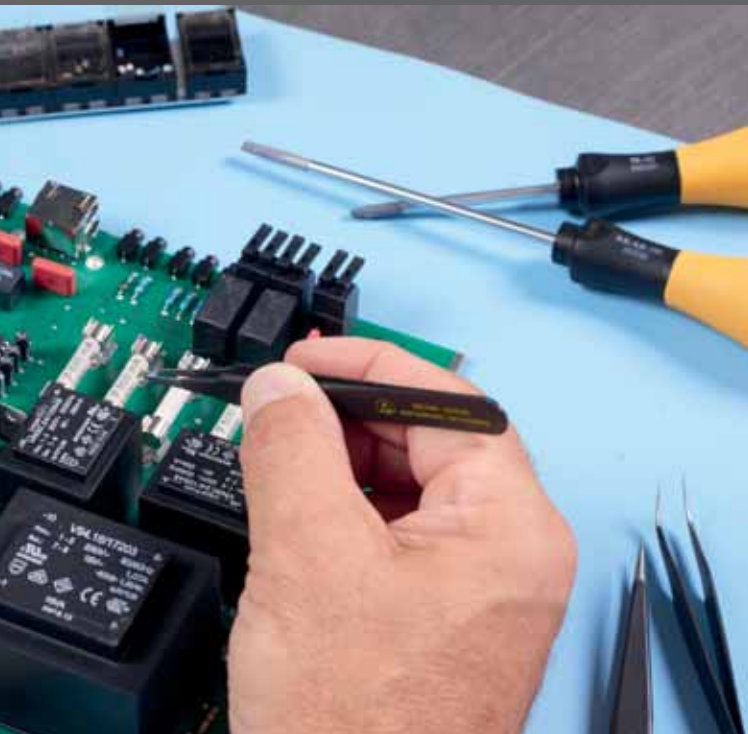
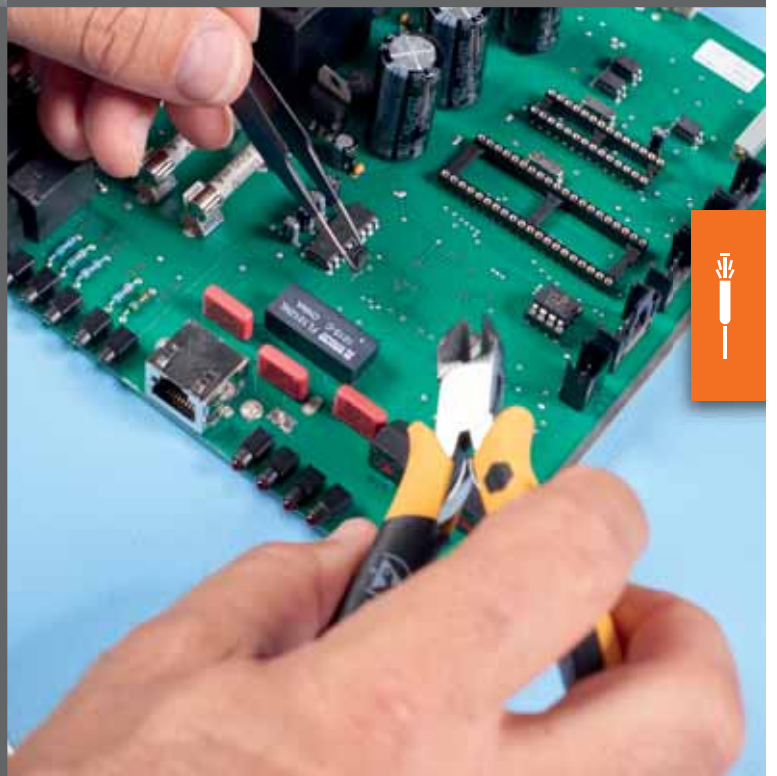



**Simplifies your work:** The ball end facilitates access to screws  
**costs:** Reduces the risk of forgetting and leaving keys inside a  
the right key in the right place with the ErgoStar holder. **Saves**  
is child's play. **Increases your efficiency:** Coloured L-keys quick  
paint visible in UV light. The required key width can be quickly  
holds all hex screws in place without a magnet.





and allows you to work at an angle of up to 25°. **Lowers your** machine and causing damage. **Makes handling easier:** Always **time:** Ensures order: removing and targeted insertion in the holder and easy to find – also in dark environments thanks to fluorescent found thanks to colour coding. Wiha MagicRing® holding feature

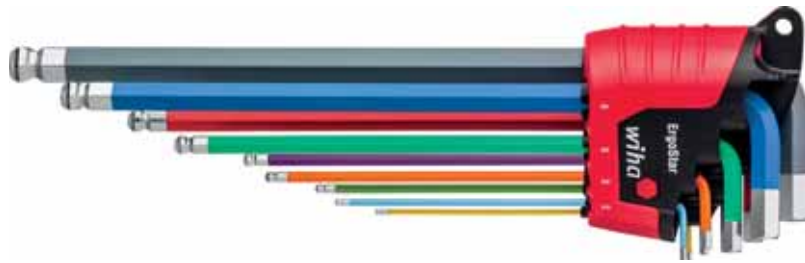

**Simplifies your work:** The ball end facilitates access to screws and allows you to work at an angle of up to 25°. **Lowers your costs:** Reduces the risk of forgetting and leaving keys inside a machine and causing damage. **Makes handling easier:** Always the right key in the right place with the ErgoStar holder. **Saves time:** Ensures order: removing and targeted insertion in the holder is child's play. **Increases your efficiency:** Coloured L-keys quick and easy to find – also in dark environments thanks to fluorescent paint visible in UV light. The required key width can be quickly found thanks to colour coding. Wiha MagicRing® holding feature holds all hex screws in place without a magnet.

### L-key set in ErgoStar holder hexagonal ball end, 9-pcs. in fluorescent colour in blister pack

Order-No. 43851

More information: Page 230



Product video:





**Simplifies your work:** The ball end facilitates access to screws and allows you to work at an angle of up to 25°. **Lowers your costs:** Highly durable thanks to high-quality, chrome-plated L-key surface to prevent corrosion. **Makes handling easier:** Always the correct key when you need it. **Saves time:** Ensures order: removing and targeted insertion in the holder is child's play. **Increases your efficiency:** Wiha MagicRing® holding feature holds all hex screws in place without a magnet.

**L-key set in ErgoStar holder  
Hexagonal ball end MagicRing®,  
9-pcs., matt chrome-plated in blister  
pack**

Order-No. 43850

More information: Page 231



Product video:

**The perfect complement:**



**Torque screwdriver set TorqueVario®-S**

Order-No. 26893

More information: Page 202





**Simplifies your work:** The ball end facilitates access to screws and allows you to work at an angle of up to 25°. **Makes handling easier:** Sliding function for one-handed opening of the holder and simple, quick removal. **Protect your health:** Reduction of the risk of injury by increasing the hand working space. **Increases your efficiency:** Improved accessibility thanks to its short side.

### L-key set in ProStar holder Matt chrome-plated hexagonal ball end with short shaft, 9-pcs. in blister pack

Order-No. 35481

More information: Page 232



Product video:

### The perfect complement:



### Screwdriver set SoftFinish®

Order-No. 41002

More information: Page 175



### L-key with short shaft

### Especially for hard-to-reach screws and confined spaces

Improved accessibility thanks to a 60% reduction in length of the short L-key side.

Increase in the hand working space of over 30% and thus a reduction of the risk of injury to the knuckles and fingertips thanks to a 95° bend of the L-key.

Ball end geometry enables fastening at an angle of up to 25°.



**Makes handling easier:** Always the correct key when you need it. **Saves time:** Ensures order: removing and targeted insertion in the holder is child's play. **Increases your efficiency:** Wiha MagicSpring® holding feature holds all Torx® screws in place without a magnet.

**L-key set in ErgoStar holder  
TORX® MagicSpring®, 13-pcs. in blister  
pack, black oxidised**

Order-No. 43848

More information: Page 235



Product video:

**The perfect complement:**



**Pliers set Classic with MagicTips®**

Order-No. 34708

More information: Page 301



**ErgoStar**

**The right L-key after just one turn.**

One turn of any L-key and all L-keys are ready for removal.

Solid stopping point for fixing L-keys in the holder.

Innovative clamping ensures L-keys are held firmly in both a closed and open position.

Compact design saves space on the work bench or in the toolbox.

**Simplifies your work:** Effortless and comfortable transmission  
**your costs:** Highly durable thanks to high-quality, chrome-plated  
Integrated side drive for effortless fastening and unfastening of



of high torques thanks to T-handle with ComfortGrip. **Lowers** L-key surface to prevent corrosion. **Increases your efficiency:** rusted or stubborn screws.

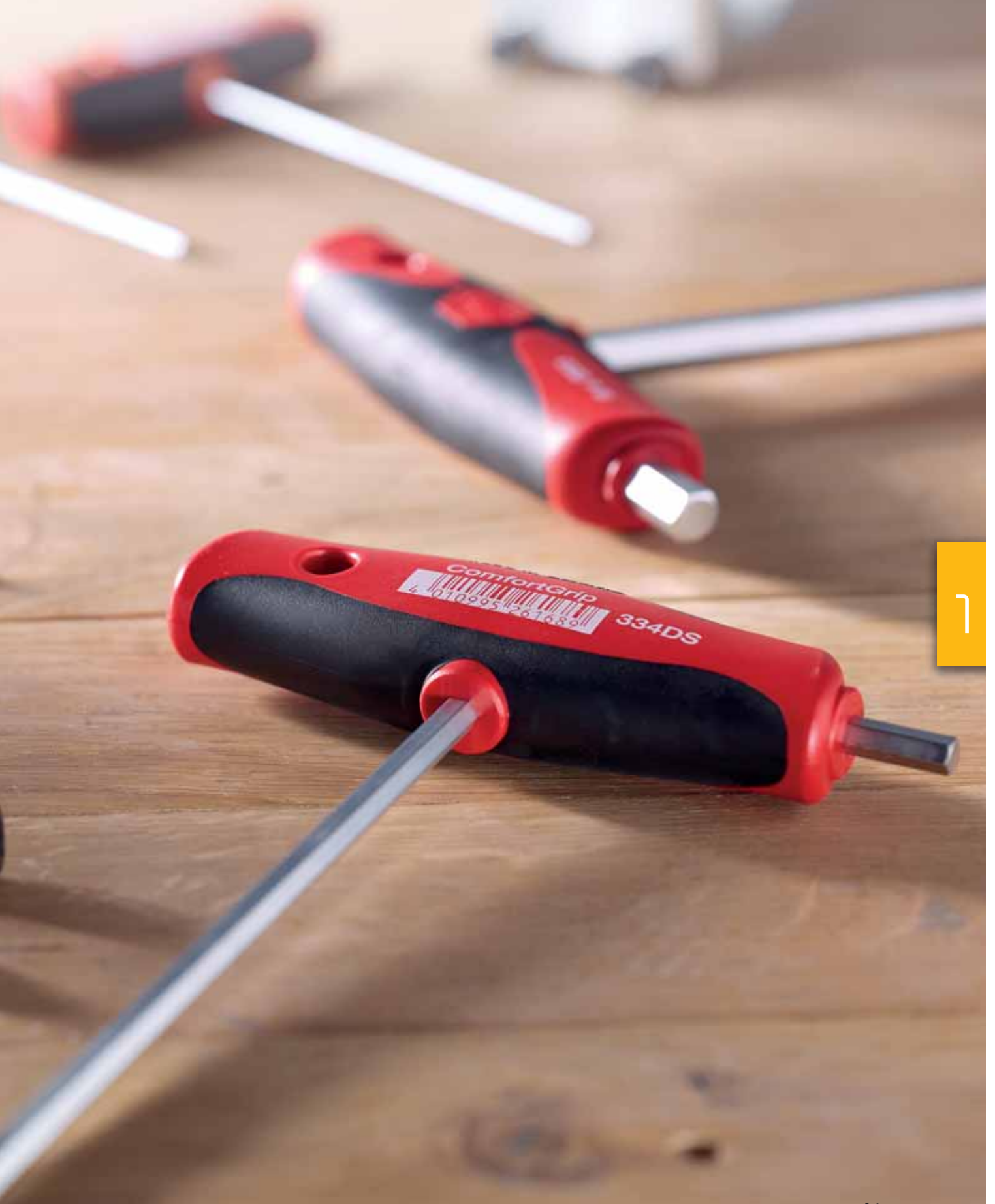



**Simplifies your work:** Effortless and comfortable transmission of high torques thanks to T-handle with ComfortGrip. **Lowers your costs:** Highly durable thanks to high-quality, chrome-plated L-key surface to prevent corrosion. **Increases your efficiency:** Integrated side drive for effortless fastening and unfastening of rusted or stubborn screws.

**L-key with T-handle set ComfortGrip  
Hexagon with side drive, matt chrome-plated 6-pcs.**

Order-No. 26247

More information: Page 239



Product video:





**Simplifies your work:** Effortless and comfortable transmission of high torques thanks to T-handle with ComfortGrip. **Lowers your costs:** Highly durable thanks to high-quality, chrome-plated L-key surface to prevent corrosion. **Increases your efficiency:** Integrated side drive for effortless fastening and unfastening of rusted or stubborn screws.

**L-key with T-handle set ComfortGrip TORX® with side drive, matt chrome-plated 6-pcs.**

Order-No. 26248

More information: Page 239

**The perfect complement:**



**Pliers set Classic**

Order-No. 26850

More information: Page 300





**Lowers your costs:** Bit quick and easy to find thanks to yellow  
**time:** No long searches thanks to fluorescent bit, infrequent bit  
thanks to clear organisation and automatic opening at the push  
120x greater lifespan\* thanks to optimised bit for Y-shaped



marking – even in dark environments by using an UV light. **Saves** replacement thanks to long lifespan. Simple and rapid bit removal of a button. **Increases your efficiency:** The specialist with screws(\*compared to Wiha standard bit)



**Lowers your costs:** Bit quick and easy to find thanks to yellow marking – even in dark environments by using an UV light. **Saves time:** No long searches thanks to fluorescent bit, infrequent bit replacement thanks to long lifespan. Simple and rapid bit removal thanks to clear organisation and automatic opening at the push of a button. **Increases your efficiency:** The specialist with 120x greater lifespan\* thanks to optimised bit for Y-shaped screws(\*compared to Wiha standard bit)

**FlipSelector Y bit set, 25 mm  
Phillips, Pozidriv, TORX®, 13-pcs.,  
1/4"**

Order-No. 41827

More information: Page 261



More information:

**The perfect complement:**



**XLSelector T bit set, 50 mm**

Order-No. 41831

More information: Page 258

**BITFINDER**

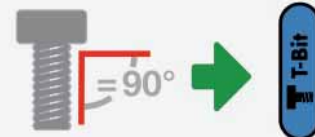



**Lowers your costs:** Bit quick and easy to find thanks to yellow marking – even in dark environments by using an UV light. **Saves time:** No long searches thanks to fluorescent bit, infrequent bit replacement thanks to long lifespan. **Increases your efficiency:** The specialist with 120x greater lifespan\* thanks to optimised bit for Y-shaped screws(\*compared to Wiha standard bit)

**XLSelector Y bit set, 50 mm**  
**Phillips, Pozidriv, TORX®, 13-pcs., 1/4"**  
 Order-No. 41834  
 More information: Page 260



More information:

**The perfect complement:**



**Bit holder CentroFix Super Slim mechanically lockable**

Order-No. 39134  
 More information: Page 280

## Wiha TY bit concept

Bits quickly and easily selected thanks to the screw head shape.

The T bit is ideal for fastening T-shaped screws with an angle of 90°.

The Y bit is ideal for fastening Y-shaped screws with an angle not equal to 90°.

Universal in its use, the TY bit is suitable for all types of screws, no matter whether they feature a Y-shaped or T-shaped screw head.





**Lowers your costs:** Bit quick and easy to find thanks to blue marking – even in dark environments by using an UV light. **Saves time:** No long searches thanks to fluorescent bit, infrequent bit replacement thanks to long lifespan. Simple and rapid bit removal thanks to clear organisation and automatic opening at the push of a button. **Increases your efficiency:** The specialist with 120x greater lifespan\* thanks to optimised bit for T-shaped screws(\*compared to Wiha standard bit)

**FlipSelector T bit set, 25 mm  
Phillips, Pozidriv, TORX®, 13-pcs.,  
1/4"**

Order-No. 41824

More information: Page 259



More information:

**The perfect complement:**



**Flashlight with LED, laser and UV light**

Order-No. 41286

More information: Page 160





**Lowers your costs:** Bit quick and easy to find thanks to blue marking – even in dark environments by using an UV light. **Saves time:** No long searches thanks to fluorescent bit, infrequent bit replacement thanks to long lifespan. **Increases your efficiency:** The specialist with 120x greater lifespan\* thanks to optimised bit for T-shaped screws(\*compared to Wiha standard bit)

**XLSelector T bit set, 50 mm**  
**Phillips, TORX®, hex 13-pcs. 1/4"**  
 Order-No. 41831  
 More information: Page 258



More information:

**The perfect complement:**



**Screwdriver with LiftUp 25 magnetic bit magazine**

Order-No. 38606  
 More information: Page 216





**Lowers your costs:** Bit quick and easy to find thanks to red marking – even in dark environments by using an UV light. **Saves time:** No long searches thanks to fluorescent bit, infrequent bit replacement thanks to long lifespan. Automatic opening at the push of a button and simple bit change directly in the holder. **Increases your efficiency:** The all-rounder with 120x greater lifespan\* thanks to patented bit technology, suitable for all screws. (\*compared to Wiha standard bit)

**BitBuddy® TY bit set, 29 mm**  
**Phillips, Pozidriv, TORX®, 8-pcs., 1/4"**  
 Order-No. 42137  
 More information: Page 257



More information:

**The perfect complement:**



**Bit holder CentroFix Force mechanically lockable**

Order-No. 39133  
 More information: Page 280



**BitBuddy 29**

**Easy, single-hand operation.**

**Attaching:**

Bits are directly picked up with the machine from the BitBuddy.

**Work:**

Gets your fastenings done.

**Storing**

Bits are easily returned to the BitBuddy, by pressing on the red bit strip.

With magnetic bit holder for a rapid bit change.

BitBuddy is always at hand - easily fits into trouser pockets or onto the belt clip.





**Lowers your costs:** Bit quick and easy to find thanks to red marking – even in dark environments by using an UV light. **Saves time:** No long searches thanks to fluorescent bit, infrequent bit replacement thanks to long lifespan. Automatic opening at the push of a button and simple bit change directly in the holder. **Increases your efficiency:** The all-rounder with 120x greater lifespan\* thanks to patented bit technology, suitable for all screws. (\*compared to Wiha standard bit)

**BitBuddy® TY bit set, 49 mm  
TORX® 1/4" 7-pcs.**

Order-No. 42115

More information: Page 256



More information:

**The perfect complement:**



**L-key set in ErgoStar holder**

Order-No. 43851

More information: Page 230



**Wiha TY bit concept**

Bits quickly and easily selected thanks to the screw head shape.

The T bit is ideal for fastening T-shaped screws with an angle of 90°.

The Y bit is ideal for fastening Y-shaped screws with an angle not equal to 90°.

Universal in its use, the TY bit is suitable for all types of screws, no matter whether they feature a Y-shaped or T-shaped screw head.

**Simplifies your work:** Actuating sleeve recoils to indicate flush magnet, even heavy screws are held securely in place.



fastening. **Increases your safety:** Thanks to the strong ring

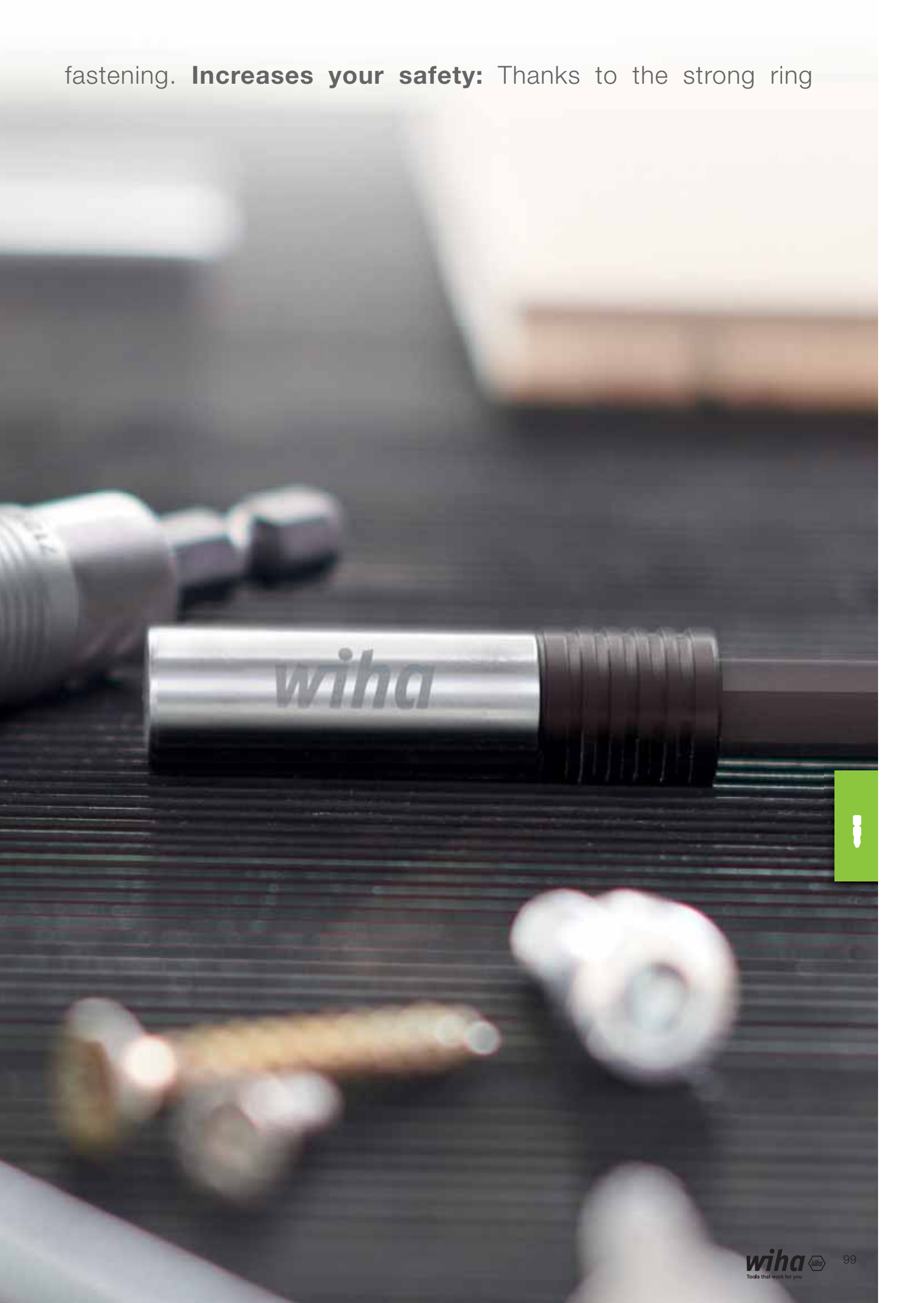



**Simplifies your work:** Actuating sleeve recoils to indicate flush fastening. **Increases your safety:** Thanks to the strong ring magnet, even heavy screws are held securely in place.

**Bit holder MagicFlip Force magnetic with ring magnet, 1/4"**

Order-No. 36800

More information: Page 280



Product video:

**The perfect complement:**



**Bit holder CentroFix Force mechanically lockable**

Order-No. 39133

More information: Page 280



**MagicFlip Force**

Facilitates the fastening of long wood screws.

Optimal holding force thanks to extremely powerful Neodym ring magnet.

FlipBack: The actuating sleeve automatically springs back during recessing.

Magnet On/Off: The ring magnet can be "deactivated" by pushing the actuating sleeve back.



**Saves time:** Rapid bit change due to easy-to-operate locking and unlocking of the holder. **Increases your efficiency:** No wobbling and an extremely secure hold thanks to the play-free guidance of bits.

### Bit holder CentroFix Force mechanically lockable

1/4", magnetic

Order-No. 39133

More information: Page 280



Product video:



### CentroFix Force

Suitable for all bits with 1/4" hex drive style C6.3 and E6.3.

**SelfLock:** The bit is locked mechanically and held securely when inserted.

**EasyOut:** When unlocked, the bit moves into the ideal removal position.



**Saves time:** Automatic bit locking mechanism upon insertion. **Increases your efficiency:** Unlimited access to deep-set screws thanks to extreme slimline design.

**Bit holder CentroFix Super Slim mechanically lockable  
1/4", magnetic**

Order-No. 39134

More information: Page 280



Product video:



## CentroFix SuperSlim

Up to 30% reduced outer diameter compared to "conventional" quick release holders.

Improved screw accessibility in confined holes.

SelfLock: The bit is locked mechanically and held securely when inserted.

EasyOut: When unlocked, the bit moves into the ideal removal position.

## Drive systems and matching bits

Bit holder	suitable for
CentroFix Force	C 6.3, E 6.3 und 1/4" drives
CentroFix SuperSlim	C 6.3
MagicFlip Force	C 6,3



**Simplifies your work:** The angled head allows you to work in  
**costs:** Durable thanks to high-quality, chrome-plated plier surface  
for three tasks: cutting to length, stripping and skinning. **Increases**  
less weight for 100% efficiency. **Offers you full protection:**  
1,000 V AC.

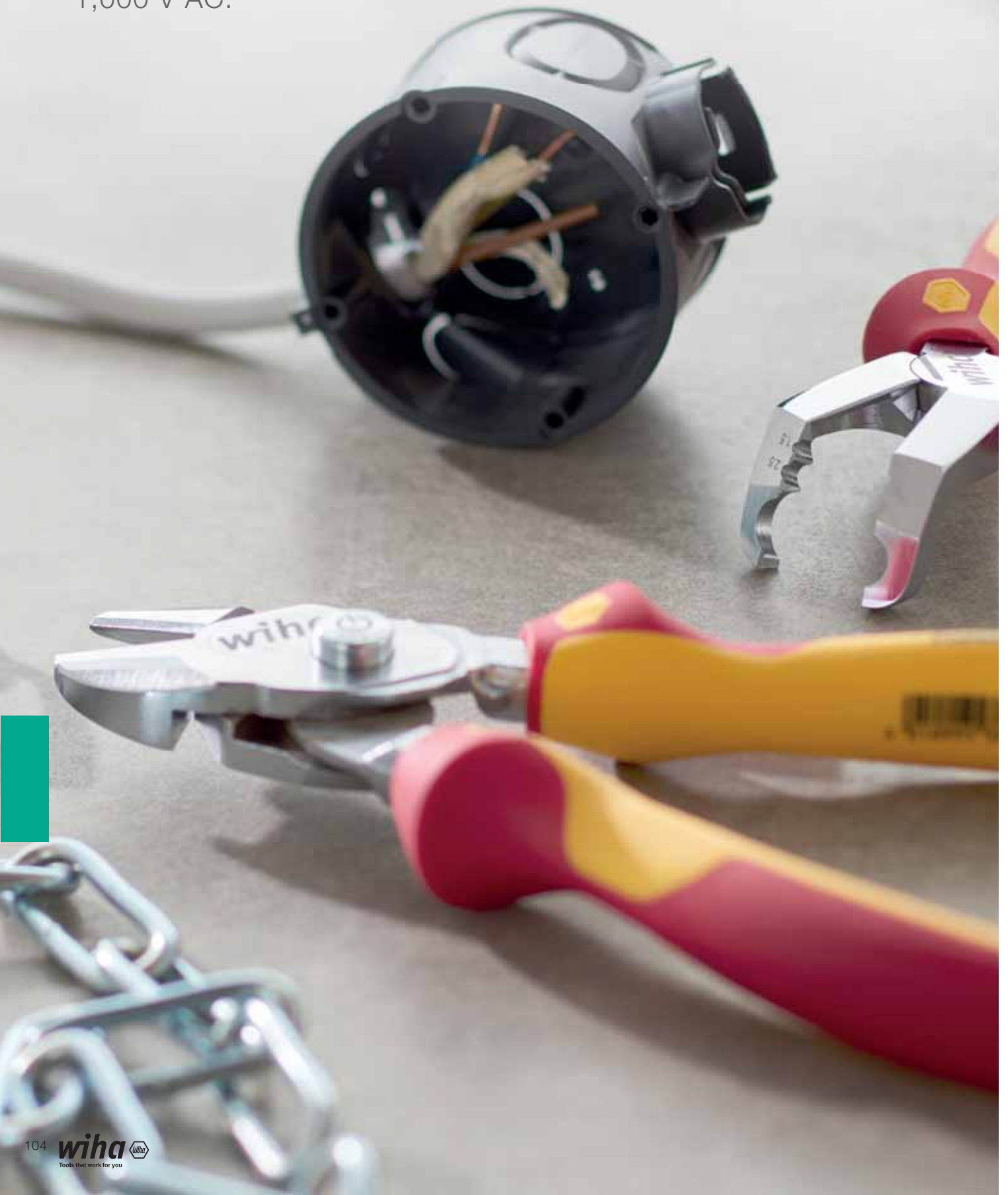



hard-to-reach places such as installation sockets. **Lowers your**  
to prevent corrosion. **Saves money:** Now you only need one tool  
**your efficiency:** Three tools in one. Saves 60% volume and 50%  
Each tool individually tested at 10,000 V AC and approved for





**Simplifies your work:** The angled head allows you to work in hard-to-reach places such as installation sockets. **Lowers your costs:** Durable thanks to high-quality, chrome-plated plier surface to prevent corrosion. **Saves money:** Now you only need one tool for three tasks: cutting to length, stripping and skinning. **Increases your efficiency:** Three tools in one. Saves 60% volume and 50% less weight for 100% efficiency. **Offers you full protection:** Each tool individually tested at 10,000 V AC and approved for 1,000 V AC.

**Installation pliers TriCut Professional electric**

Order-No. 38552  
More information: Page 287



Product video:

**The perfect complement:**



**Professional BiCut® high-performance diagonal cutters with DynamicJoint®**

Order-No. 38191  
More information: Page 288

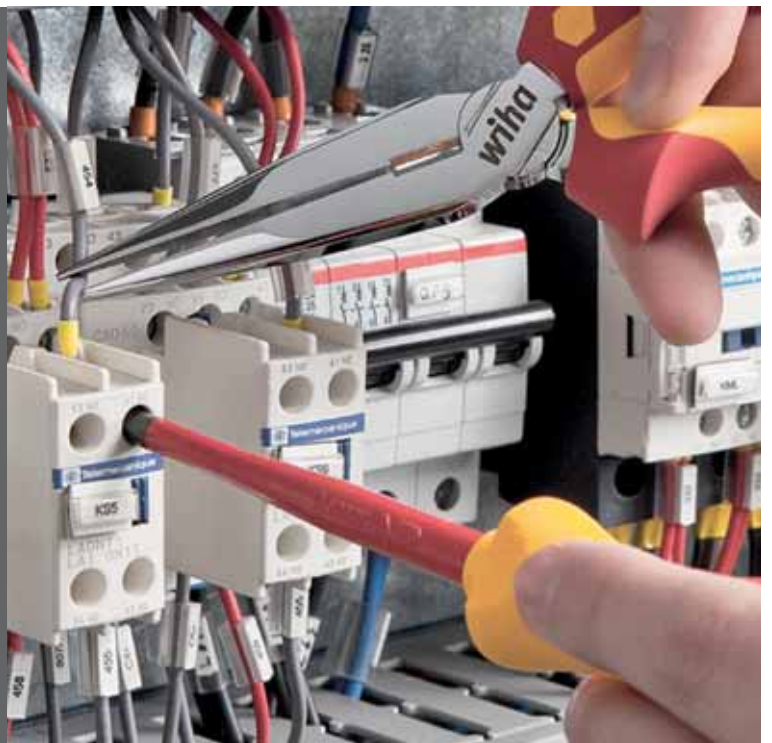



**Lowers your costs:** Durable thanks to high-quality, chrome-plated plier surface to prevent corrosion. **Protect your health:** Requires less force and reduces pressure on the wrists. **Increases your efficiency:** Two pliers in one - 200 % power at the touch of a button, available at any time. **Offers you full protection:** Each tool individually tested at 10,000 V AC and approved for 1,000 V AC.

**BiCut® Professional electric high-performance diagonal cutters with DynamicJoint® Switchable**

Order-No. 38191  
More information: Page 288



Product video:

**The perfect complement:**



**Screwdriver and bit set slimVario® screwdriver**

Order-No. 41231  
More information: Page 164

**VDE-certified tools**

**Insulated tools are essential for all work on or around live components.**

Wiha VDE-tested tools are subject to stringent safety test procedures.

All tools with the special marking have been tested at 10,000 V AC and are therefore approved for use at 1,000 V AC and 1,500 V DC.

Certified by the VDE Testing and Certification Institute and individually tested according to the international standard IEC 60900.

The following equipment is required for all work on or around live components and should be appropriate for the specific task

- insulating personal protective equipment
- insulating safety mechanisms
- insulated tools

Before starting work, you must disconnect all active, live components of electrical machines and equipment and ensure that they remain disconnected while you carry out the work.

This is achieved by complying with the five safety rules:

- disconnect
- secure against reconnection
- ensure power is switched off
- earth and short-circuit
- cover or block off adjacent live components



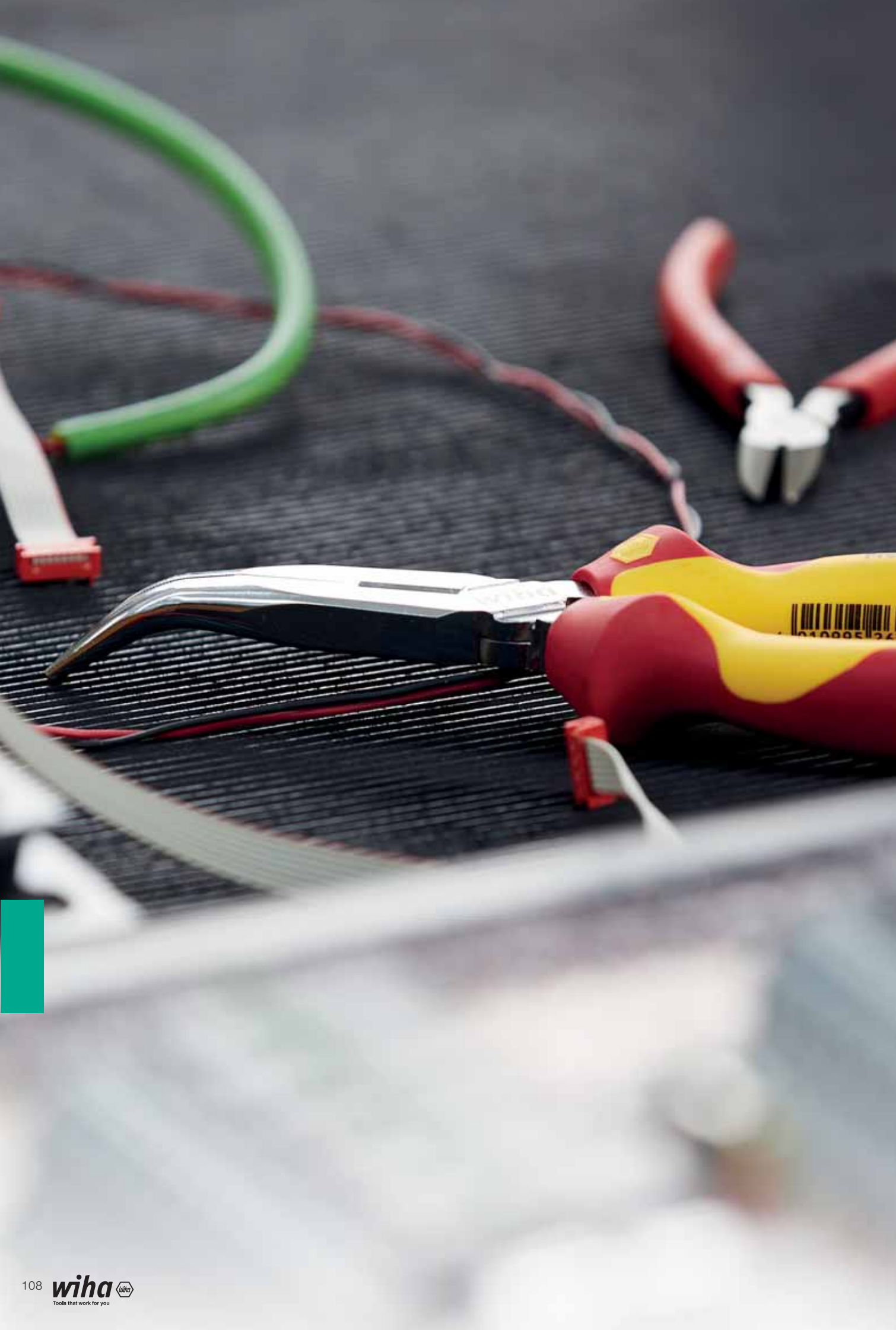



**Lowers your costs:** Durable thanks to high-quality, chrome-plated plier surface to prevent corrosion. **Increases your safety:** Wiha combination pliers enable safe, non-slip gripping in all work situations. **Protect your health:** Special DynamicJoint® design reduces effort required for cutting. **Increases your efficiency:** Wiha needle nose pliers with extra-long plier head for inserting low-lying components. **Offers you full protection:** Each tool individually tested at 10,000 V AC and approved for 1,000 V AC.

**Pliers set Professional electric  
Combination pliers, needle nose pliers,  
diagonal cutters 3-pcs.**

Order-No. 26852

More information: Page 286

**The perfect complement:**



**Screwdriver set SoftFinish® electric  
slimFix**

Order-No. 41003

More information: Page 165





**Lowers your costs:** An integrated lever enables users to interrupt  
**your safety:** Safe work through feed aid prevents crimping the  
Thanks to hexagonal crimping, small wire-end sleeves no longer  
of wire-end sleeve size with suitable crimping force for a large



the crimping process at any time to protect the pliers. **Increases** plastic cover of wire-end sleeves. **Makes handling easier:** get caught. **Increases your efficiency:** Automatic adjustment coverage area of 0.08-16mm<sup>2</sup>.



**Lowers your costs:** Long-lasting and robust thanks to metal blade insert. **Protect your health:** Damper enclosed for large cable cross-sections to reduce recoil and protect wrists. **Saves time:** Blades quickly exchanged by immediately available replacement blades in the handle. **Increases your efficiency:** Automatic stripping pliers for a wide range of cables between 0.03 and 16 mm<sup>2</sup>.

### Stripping tool automatic up to 16 mm<sup>2</sup> in blister pack

Order-No. 42062

More information: Page 295



Product video:

### The perfect complement:



### Torque screwdriver set TorqueVario®-S electric

Order-No. 36791

More information: Page 194



### Stripping tool, automatic up to 16mm<sup>2</sup>

These pliers can handle a wide range of cables, thus combining two pairs of pliers in one.

The supplied damper can be used to lessen recoil caused by larger cable gauges, such as those greater than 6 mm<sup>2</sup>, thus helping to protect wrists.

Precise cutting to length thanks to adjustable longitudinal stop.

Integrated hand protection along the cutting edge guards against injury.





**Lowers your costs:** An integrated lever enables users to interrupt the crimping process at any time to protect the pliers. **Increases your safety:** Safe work through feed aid prevents crimping the plastic cover of wire-end sleeves. **Makes handling easier:** Thanks to hexagonal crimping, small wire-end sleeves no longer get caught. **Increases your efficiency:** Automatic adjustment of wire-end sleeve size with suitable crimping force for a large coverage area of 0.08-16mm<sup>2</sup>.

### Automatic crimp tool for wire-end sleeves hex crimping

Order-No. 41246

More information: Page 298



Product video:

### The perfect complement:



### Stripping tool automatic

Order-No. 42062

More information: Page 295



### Automatic crimp tool

Process-safe hexagonal crimping prevents smaller wire-end sleeves from snagging.

These crimping pliers can handle all standard applications with a crimping range between 0.08 and 16 mm<sup>2</sup>.

Suitable for both single wire-end sleeves and twin wire-end sleeves thanks to automatic crimping.



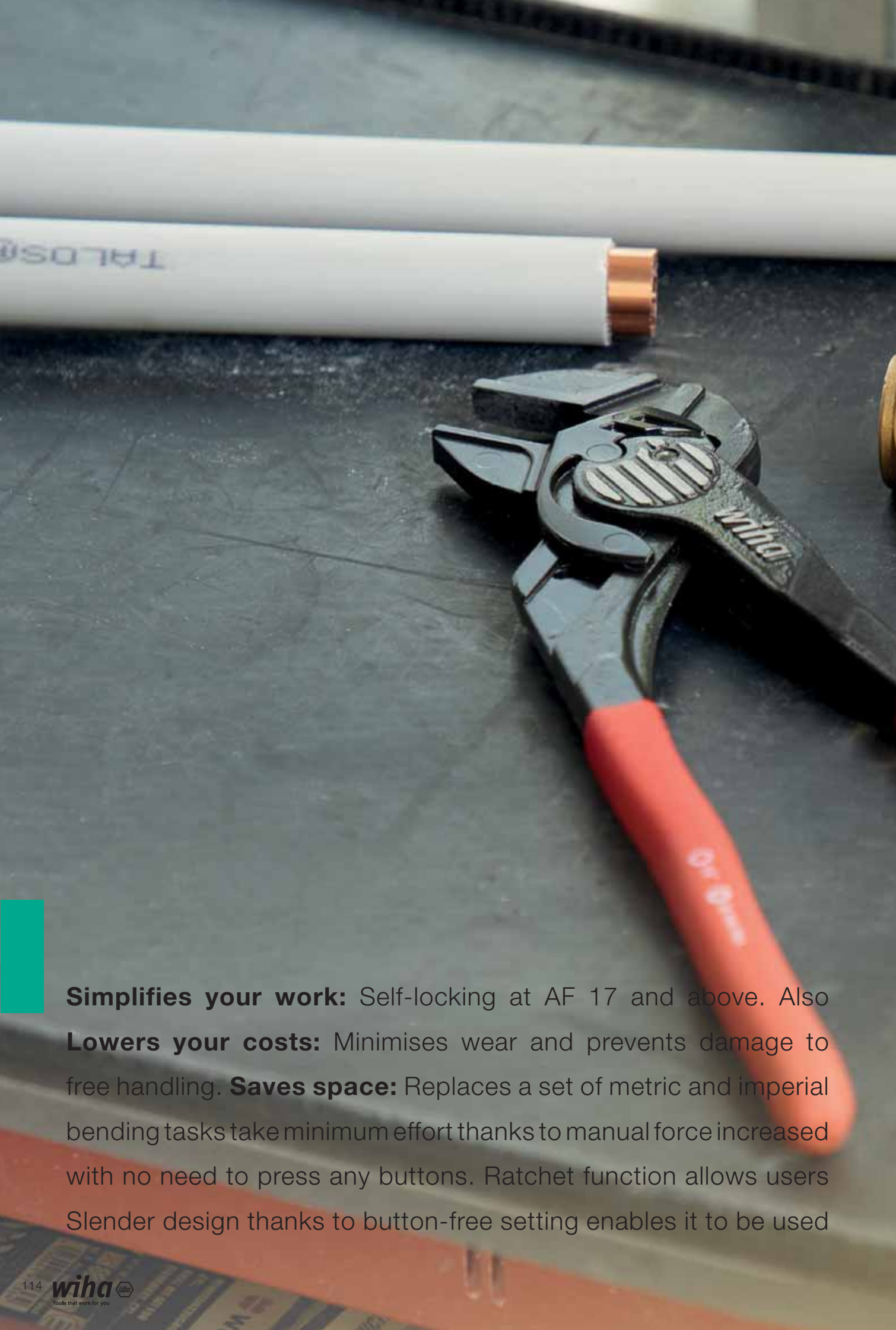

**Simplifies your work:** Self-locking at AF 17 and above. Also  
**Lowers your costs:** Minimises wear and prevents damage to  
free handling. **Saves space:** Replaces a set of metric and imperial  
bending tasks take minimum effort thanks to manual force increased  
with no need to press any buttons. Ratchet function allows users  
Slender design thanks to button-free setting enables it to be used

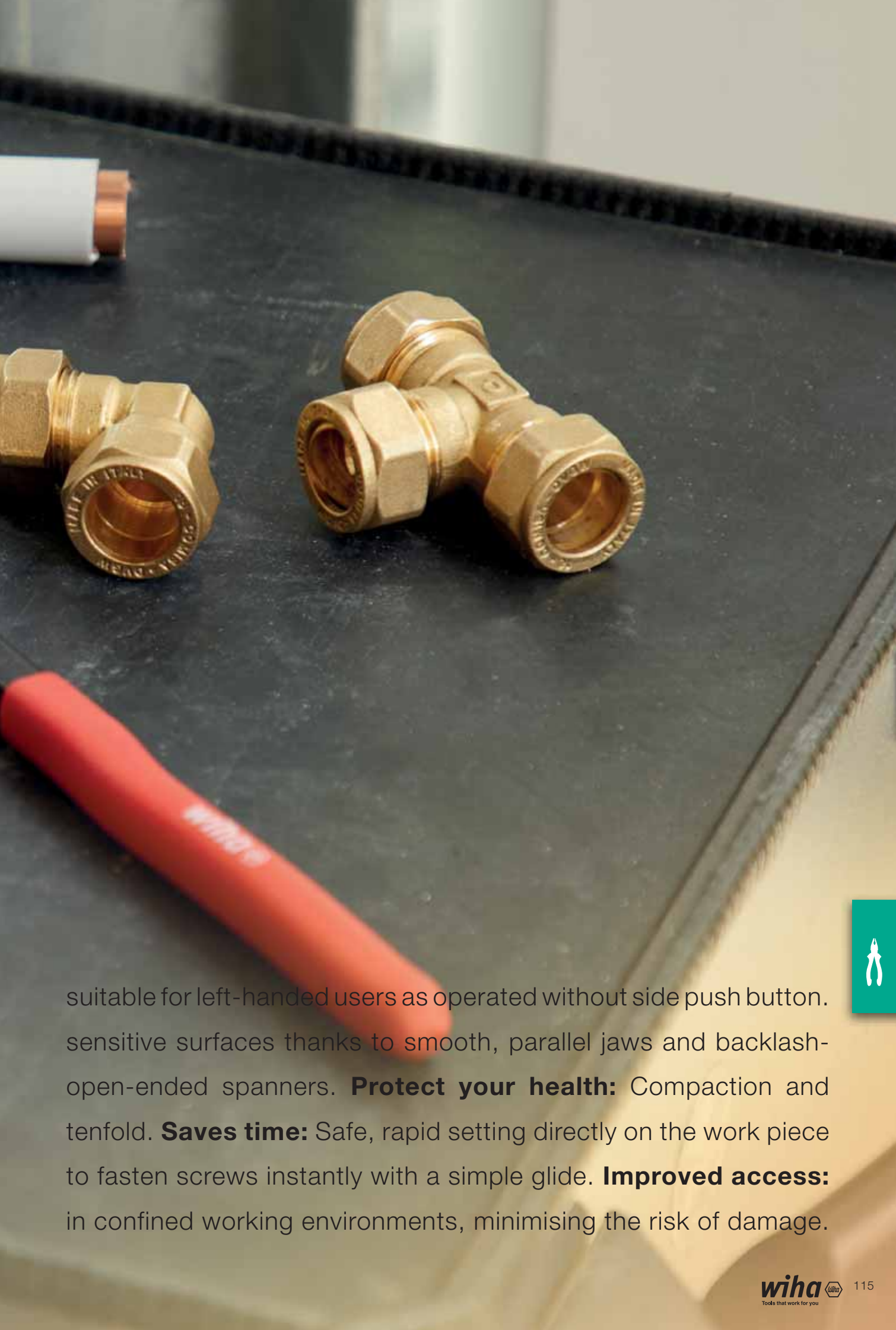

suitable for left-handed users as operated without side push button. sensitive surfaces thanks to smooth, parallel jaws and backlash-open-ended spanners. **Protect your health:** Compaction and tenfold. **Saves time:** Safe, rapid setting directly on the work piece to fasten screws instantly with a simple glide. **Improved access:** in confined working environments, minimising the risk of damage.



**Simplifies your work:** Self-locking at AF 17 and above. Also suitable for left-handed users as operated without side push button. **Lowers your costs:** Minimises wear and prevents damage to sensitive surfaces thanks to smooth, parallel jaws and backlash-free handling. **Saves space:** Replaces a set of metric and imperial open-ended spanners. **Protect your health:** Compaction and bending tasks take minimum effort thanks to manual force increased tenfold. **Saves time:** Safe, rapid setting directly on the work piece with no need to press any buttons. Ratchet function allows users to fasten screws instantly with a simple glide. **Improved access:** Slender design thanks to button-free setting enables it to be used in confined working environments, minimising the risk of damage.

### Pliers wrench Classic

Order-No. 40923

More information: Page 308



Product video:



**Lowers your costs:** Durable thanks to high-quality, chrome-plated plier surface to prevent corrosion. **Increases your safety:** Wiha combination pliers enable safe, non-slip gripping in all work situations. **Makes handling easier:** Wiha QuickFix water pump pliers with simple and rapid opening width setting, especially during constantly changing applications. **Protect your health:** Special DynamicJoint® design reduces effort required for cutting.

**Pliers set Professional**  
**High-leverage combination pliers, water pump pliers, heavy-duty diagonal cutters, 3-pcs.**

Order-No. 26854  
 More information: Page 300

**The perfect complement:**



**Screwdriver set MicroFinish®**

Order-No. 29138  
 More information: Page 187



**OptiGrip**

**Wiha OptiGrip – optimal grip due to newly designed gripping surfaces**

A firm hold: The „triple-point support“ protects the workpiece from twisting or slipping.

Highly effective: Optimum grip even with large jaw opening – and at the same time significantly less force needed.

A wide selection: Now in standard Wiha combination pliers and high leverage combination pliers.





**Lowers your costs:** Prevents damage caused by lost circlips in the work area. **Saves time:** Safe and sturdy grip on circlips.

**Pliers set Classic with MagicTips®  
Circlip pliers 4-pcs.**

Order-No. 34708

More information: Page 301



Product video:

**The perfect complement:**



**Screwdriver with interchangeable  
blade set SYSTEM 6**

Order-No. 00623

More information: Page 221



**MagicTips®**

**Wiha MagicTips® – Top of their class.**

**Maximum grip:** The special latching function preventing jumping away of the safety rings makes the Wiha circlip pliers truly unique.

**Hard as steel:** Additional hardening of tips means high wear resistance and therefore excellent durability.

**Precise:** Precision tips of high performance steel for maximum grip and high stability.



**Lowers your costs:** Durable thanks to high-quality, chrome-plated plier surface to prevent corrosion. **Protect your health:** Requires less force and reduces pressure on the wrists. **Increases your efficiency:** Two pliers in one - 200 % power at the touch of a button, available at any time.

**Professional BiCut® high-performance diagonal cutters with DynamicJoint® Switchable**

Order-No. 38190

More information: Page 301



Product video:

**The perfect complement:**



**Screwdriver set SoftFinish®**

Order-No. 41002

More information: Page 175



**DynamicJoint®**

Wiha DynamicJoint® – A new dimension in strength and durability

Innovative: Optimised joint construction.

Effective: Minimal power loss means less force needed for cutting.

Permanent: Optimal performance even after thousands of cuts.



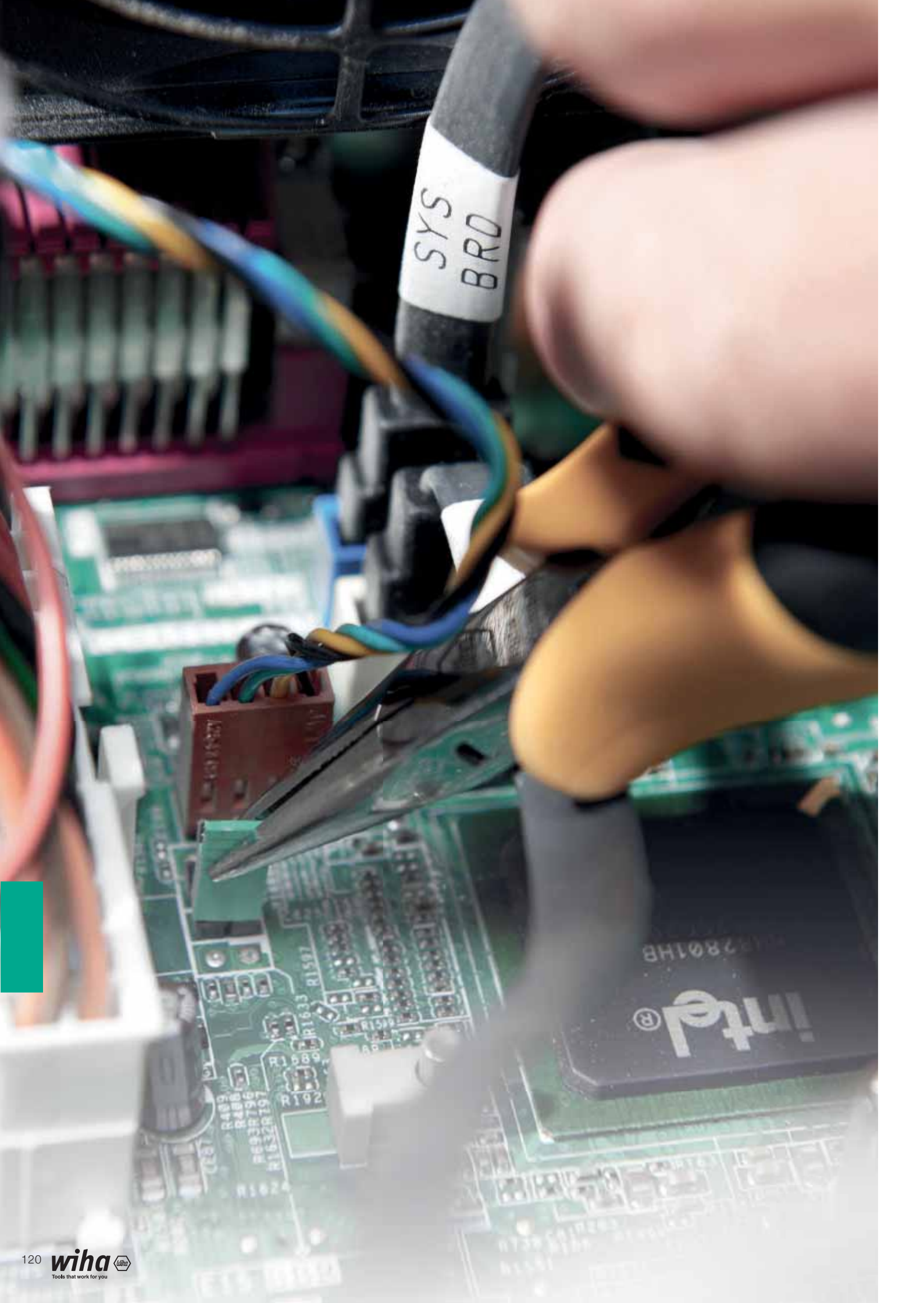

SYS  
BRD

intel®  
2801HB





**Meets your requirements:** Universal set for various cutting applications, secure hold and feeding in the electronics sector. **Lowers your costs:** Electrostatically conductive tools protect electronic components from damage.

**Pliers set Professional ESD**  
**Diagonal cutters, oblique end cutting nippers, needle nose pliers, 4-pcs. in tool pouch**

Order-No. 33507

More information: Page 316

**The perfect complement:**



**Screwdriver handle SoftFinish®-telescopic ESD**

Order-No. 31498

More information: Page 227



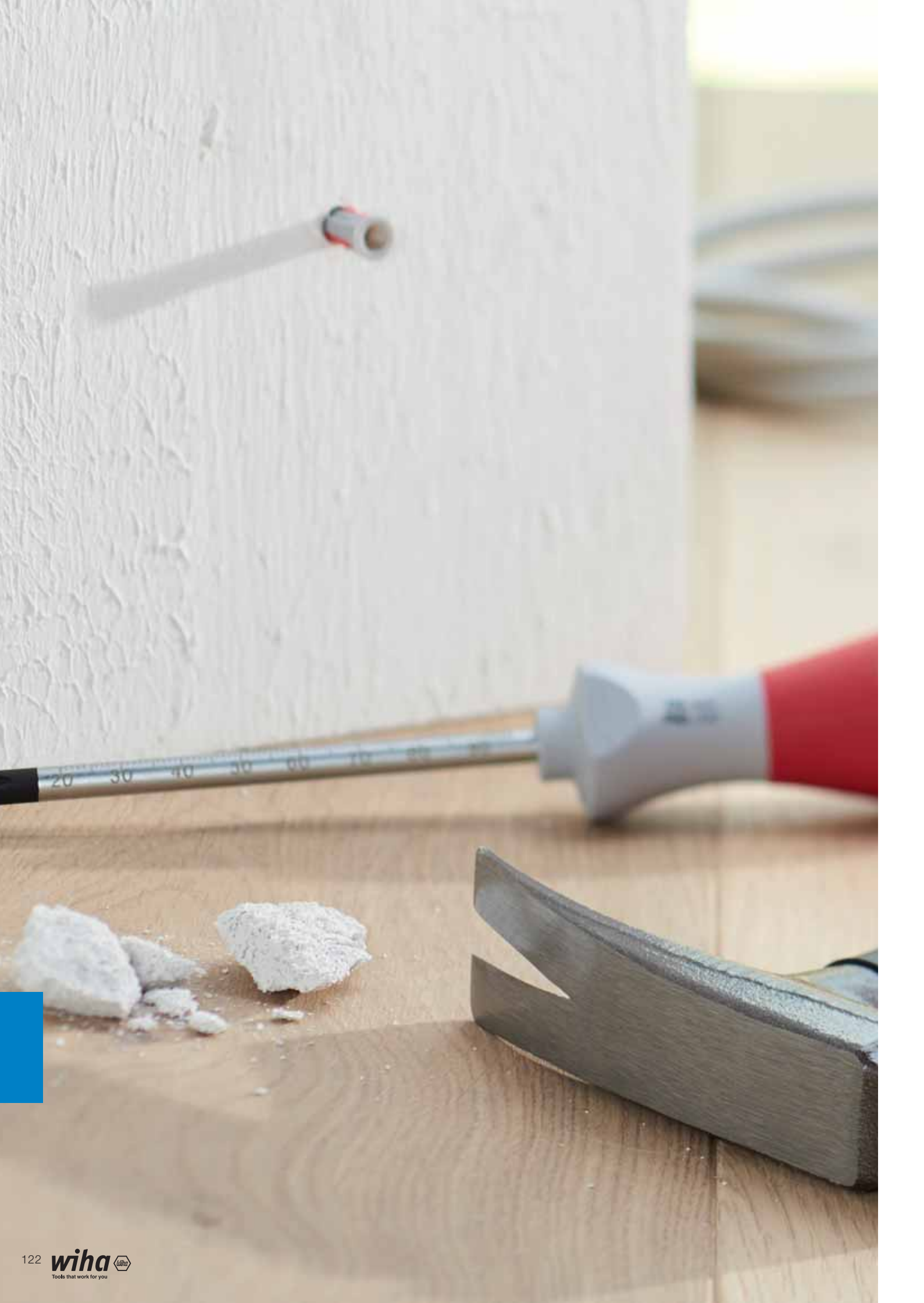

**Simplifies your work:** Flat claws allow you to remove nails and nail clamps easily. **Increases your efficiency:** Perfect balance thanks to optimum weight distribution for effective handling. **Improved access:** Perfectly suited for use in confined working environments thanks to the combination of a square and round head shape. **Increases the quality of your work:** The flat surface on the hammer handle ensures cables and dowels are fitted into position without causing any damage.





**Simplifies your work:** Flat claws allow you to remove nails and nail clamps easily. **Increases your efficiency:** Perfect balance thanks to optimum weight distribution for effective handling. **Improved access:** Perfectly suited for use in confined working environments thanks to the combination of a square and round head shape. **Increases the quality of your work:** The flat surface on the hammer handle ensures cables and dowels are fitted into position without causing any damage.

**Electrician's hammer with 300 g hammer head, in blister pack**

Order-No. 42071

More information: Page 334



Product video:

**The perfect complement:**



**SoftFinish® dowel racket set with dowels**

Order-No. 41289

More information: Page 334



**Electrician's hammer**

With its optimally uniform weight distribution, this hammer ensures perfect balance, delivering impact and fatigue-free work.

Its flat claws make it easier to remove fastening components such as nail clamps, even from difficult-to-access spots.

Optimum access into corners and confined spaces thanks to U-shaped striking surface.

The flat hammer handle lower surface acts as a soft-faced hammer, ensuring components such as cables and dowels are fixed into position without causing damage.



**Simplifies your work:** Dirt- and dust-free work compared to when machines are used. **Increases your safety:** Galvanic separation in the handle prevents a discharge between the striking cap and the blade. **Protect your health:** Dowel hole can be made anywhere using a hammer at any time, even near power sockets. **Saves time:** Hammer dowel holes anywhere at any time without worrying how near you are to wall sockets. **Increases your efficiency:** Scaled impact screwdriver blade provides more detailed depth measurement. Perfectly dimensioned dowel hole thanks to blade adjusted to required size.

**SoftFinish® dowel racket set with dowels**  
**Phillips with 6 mm round blade in blister pack, 5-pcs.**

Order-No. 41289

More information: Page 334



Product video:

**The perfect complement:**



**Electrician's spirit level**

Order-No. 42074

More information: Page 335



**SoftFinish® dowel racket set with dowels**

Makes it easier to insert dowels and saves valuable working time.

Ensures dirt- and dust-free work compared to machines.

Galvanic separation between the blade and solid steel cap protects against electric shock.

Perfect for portable use since you can make dowel holes anywhere at any time at the strike of a hammer.



**Simplifies your work:** Dirt- and dust-free work compared to when the handle prevents a discharge between the striking cap and the using a hammer at any time, even near power sockets. **Saves** how near you are to wall sockets. **Increases your efficiency:** measurement. Perfectly dimensioned dowel hole thanks to blade

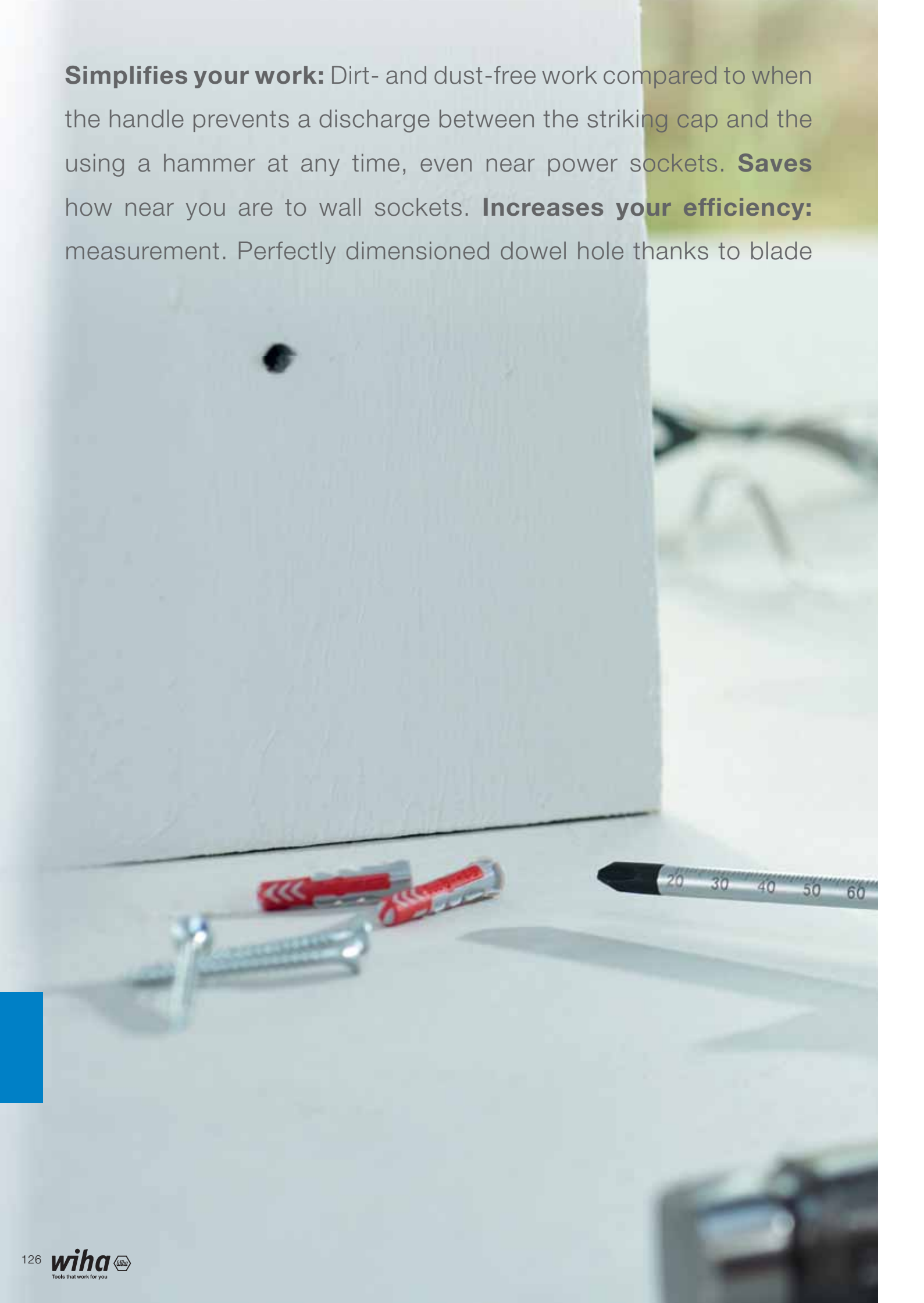

machines are used. **Increases your safety:** Galvanic separation in blade. **Protect your health:** Dowel hole can be made anywhere **time:** Hammer dowel holes anywhere at any time without worrying Scaled impact screwdriver blade provides more detailed depth adjusted to required size.





**Meets your requirements:** Hammer components in a practical Wiha safety set with replaceable hammer heads of various degrees of hardness for all applications. **Simplifies your work:** Makes work easier, optimum impact effect and less effort needed. **Lowers your costs:** Each hammer component is available individually as a spare part.

**Soft-faced hammer set Safety  
with assorted hammer faces, 8-pcs. in  
box**

Order-No. 44008

More information: Page 328

**The perfect complement:**



**Electrician's spirit level**

Order-No. 42074

More information: Page 335





**Meets your requirements:** Yellow hammer head / medium-hard: e.g. for tool and machine engineering, car repairs, sheet metal and assembly work. **Simplifies your work:** Makes work easier, optimum impact effect and less effort needed. **Protect your health:** Deadblow Hammering without recoil minimises loads on joints, tendons and muscles.

**Soft-faced hammer dead-blow, medium hard**  
**With steel tube handle, round hammer face**

Order-No. 02122  
More information: Page 332

**The perfect complement:**



**L-key set in ErgoStar holder**

Order-No. 43851  
More information: Page 230



### No-recoil soft-faced hammer

The special metal filling in the hammer head prevents recoil.

Approx. 25% more hammer head mass provides additional power.

Preserves delicate surfaces and edges through high-impact effect.



**Simplifies your work:** Comfortable measurement in different when viewed from above. **Saves space:** Perfectly portable; fits 4 flush boxes. **Increases your efficiency:** Both bubbles can be



work positions thanks to the ingeniously positioned scales, even into Wiha cases. **Saves time:** Variable distance marks for up to seen easily even from an acute angle.





**Simplifies your work:** Comfortable measurement in different work positions thanks to the ingeniously positioned scales, even when viewed from above. **Saves space:** Perfectly portable; fits into Wiha cases. **Saves time:** Variable distance marks for up to 4 flush boxes. **Increases your efficiency:** Both bubbles can be seen easily even from an acute angle.

## Electrician's spirit level

40 cm

Order-No. 42074

More information: Page 335



Product video:



## Electrician's spirit level, 40 cm

Quick, easy marking of positions for up to four flush boxes in just one simple work step thanks to the integrated marking points.

The continuous housing allows users to mark lines without interruption.

An additional scale on the upper surface ensure precise measurement even when viewing from above.

The bubbles are clearly visible, even from a sharp angle.

The level is perfectly suitable for portable use thanks to its compact design.



## Content

**Competence XXL II  
electrician's tool set**  
Page 138



**Tool set service technician**  
Page 142



**Tool set slimVario® electric**  
Page 143



**Tool set electrician**  
Page 143



**E-screwdriver, set 2, speedE®**  
Page 156



**speedE® Industrial  
e-screwdriver set**  
Page 159



**Flashlight with LED, laser and  
UV light**  
Page 160



**Single-pole, non-contact volt  
detector, 12–1,000 V AC**  
Page 160



**Screwdriver and bit set  
slimVario® screwdriver**  
Page 164



**slimBit electric bit set**  
Page 168



**Screwdriver SoftFinish® elec-  
tric slimFix**  
Page 172



**Screwdriver SoftFinish®**  
Page 178



**LiftUp 26one® skruetrækker  
med bitmagasin**  
Page 194



**Torque screwdriver  
TorqueVario®-S electric**  
Page 195



**Torque screwdriver with  
T-handle TorqueVario®-S T  
electric**  
Page 200



**Torque screwdriver iTorque®**  
Page 201



**Screwdriver with bit magazine  
LiftUp electric**  
Page 214



**Screwdriver with bit magazine,  
LiftUp 26one®**  
Page 214



**Multitool PocketStar**  
Page 217



**Nut driver insert set gripper,**  
Page 220



**L-key set in ErgoStar holder**  
Page 230



**L-key set in ProStar holder**  
Page 232



**L-key set in ProStar  
holders**  
Page 232



**L-key set in ErgoStar holder**  
Page 235



**BitBuddy® TY bit set, 29 mm**  
Page 257



**XLSelector T bit set, 50 mm**  
Page 258



**TY bit set 29 mm**  
Page 258



**T bit set, 25 mm**  
Page 260



**Installation pliers TriCut  
Professional electric**  
Page 287



**Combination pliers  
Professional electric with  
DynamicJoint® and OptiGrip**  
Page 290



**Stripping tool automatic**  
Page 295



**Automatic crimp tool, for wire-  
end sleeves hex crimping**  
Page 298



**Soft-faced hammer set Safety**  
Page 328



**Soft-faced hammer Safety  
soft/medium hard**  
Page 329



**Soft-faced hammer dead-blow,  
medium hard**  
Page 332



**Electrician's hammer**  
Page 334



**Ratchet wrench set insulated 3/8"**  
Page 147



**Tool set mechanic**  
Page 151



**Tool set ESD**  
Page 153



**Ranges**  
From page 136

**Torque QuickCheck torque testing device**  
Page 161



**Electro**  
From page 154

**Fine screwdriver PicoFinish**  
Page 184



**Screwdriver MicroFinish®**  
Page 187



**Screwdriver SoftFinish® ESD**  
Page 189



**Screwdrivers**  
From page 162

**Torque screwdriver TorqueVario®-S**  
Page 202



**Torque screwdriver with T-handle TorqueVario®-S T**  
Page 206



**Torque screwdriver TorqueVario®-S ESD**  
Page 209



**Torque tools**  
From page 192

**Screwdriver with interchangeable blade set SYSTEM 6**  
Page 221



**Screwdriver with interchangeable blade set SYSTEM 6**  
Page 221



**Screwdriver with interchangeable blade set SYSTEM 4 ESD**  
Page 223



**Multitools**  
From page 212

**L-key set in ProStar holder**  
Page 237



**L-key with T-handle ComfortGrip**  
Page 247



**L-key with key handle**  
Page 251



**L-keys**  
From page 228

**Y bit set, 25 mm**  
Page 261



**Bit Professional 1/4"**  
Page 270



**Bit holder CentroFix Force mechanically lockable 1/4", magnetic**  
Page 280



**Bits**  
From page 254

**Professional BiCut® high-performance diagonal cutters with DynamicJoint®, Switchable**  
Page 301



**Pliers wrench Classic**  
Page 308



**Classic circlip pliers with MagicTips®, straight**  
Page 312



**Pliers**  
From page 284

**SoftFinish® dowel racket set with dowels**  
Page 334



**Electrician's spirit level 40 cm**  
Page 335



**Electrician's Longlife® folding ruler, 2 m metric, 10 segments**  
Page 336



**Impact tools / Measurement tools**  
From page 326

**Information**  
From page 338





## **Ranges**

**Designed for those who work with it.**



















The experiences of the user are taken into account right from the product development stage at Wiha tools. This ensures high-quality tool sets are designed for mechanics, electricians and electronics technicians which have been specifically compiled for their particular requirements and applications. Neatly stored and clearly organised in robust, compact tool bags, tools are ready at hand, ensuring work is completed easily and efficiently.

Wiha tools prove to be very handy, essential companions stored in a Wiha tool case, where the limitations of conventional tool cases have been eliminated: thanks to its practical tool pockets and extra storage space for small parts, the Wiha tool case provides simple, strain-free transport of your tools, offering greater convenience to make your work easier in every respect.



## Application

## Ranges

<p><b>For applications in electrics</b></p> 	<p><b>Competence XXL II electrician's tool set assorted in case 115-pcs.</b> Page 138</p> 	<p><b>Tool set electrician Competence XL assorted 80-pcs. in case</b> Page 140</p> 	<p><b>Tool set service technician assorted 29-pcs. in bag</b> Page 142</p> 	<p><b>Tool set slimVario® electric, mixed, 31-pcs. in functional bag</b> Page 143</p> 
	<p><b>Tool set slimVario® electric Mixed, 12-pcs. in tool pouch</b> Page 144</p> 	<p><b>Tool set electrician Screwdriver, diagonal cutters, 6-pcs. in tool pouch</b> Page 144</p> 	<p><b>Tool set electrician assorted slotted, Phillips, 10-pcs. in belt pouch</b> Page 146</p> 	<p><b>Tool set electrician 19-pcs. in roll-up bag</b> Page 145</p> 
	<p><b>Tool set electrician 20-pcs. in case</b> Page 147</p> 	<p><b>Ratchet wrench set insulated 3/8" 20-pcs. in case</b> Page 147</p> 	<p><b>Single open-end spanner set, insulated 6-32 mm 20-pcs. in case</b> Page 148</p> 	
<p><b>For applications in mechanics</b></p> 	<p><b>Tool set mechanic Mixed, 31-pcs. in tool pouch</b> Page 151</p> 	<p><b>Tool set mechanic Screwdriver, combination pliers, 6-pcs. in tool pouch</b> Page 152</p> 		
<p><b>For applications in electronics</b></p> 	<p><b>Tool set ESD Pliers, screwdriver, tweezers, 9-pcs. in bag</b> Page 153</p> 			





assorted in case 115-pcs.

9500-704

Order-No.



42069

1





**Fastening / jamming**

- ⊖ ⊕ ⊕ ⊕ Torque screwdriver set TorqueVario®-S electric (36791) 0,8-5,0 Nm  
 1 x Torque screwdriver TorqueVario®-S electric Variable torque limit settings / 1 x Adjusting tool for torque screwdriver with long handle /  
 1 x Adapter TorqueVario-S electric for slimBits 1 x 2,5 / 1 x 3,5 / 1 x 5,5 / 1 x 6,5 / 1 x PH1 / 1 x PH2 / 1 x PZ1 / 1 x PZ2 / 1 x SL/PZ1 /  
 1 x SL/PZ2 / 1 x T9 / 1 x T10 / 1 x T15 / 1 x T20 / 1 x T25
- ⊖ ⊕ ⊕ Screwdriver with bit magazine LiftUp electric (41234)  
 1 x 2,5 / 1 x 3,5 / 1 x 5,5 / 1 x PZ1 / 1 x PZ2 / 1 x SL/PZ2
- Screwdriver with bit holder SoftFinish® electric slimVario Stubby for slimBits, VDE and GS tested (41229)
- ⊕ slimBit electric bit Pozidriv, VDE and GS tested / PZ2 x 75 (34586)
- ⊖ Screwdriver SoftFinish® electric slimFix Slotted, VDE and GS tested / 3,5 x 100 (35446) / 5,5 x 125 (35391) / 6,5 x 150 (35392)
- ⊕ Screwdriver SoftFinish® electric slimFix Phillips, VDE and GS tested / PH1 x 80 (35393) / PH2 x 100 (35394)
- ⊕ Screwdriver SoftFinish® electric slimFix Pozidriv, VDE and GS tested / PZ1 x 80 (35395) / PZ2 x 100 (35396)
- ⊕ Screwdriver SoftFinish® electric slimFix PlusMinus/Pozidriv, VDE and GS tested / SL/PZ1 x 80 (36329) / SL/PZ2 x 100 (36330)
- ⊕ Screwdriver SoftFinish® electric slimFix TORX® Tamper Resistant (with hole), VDE and GS tested / T10H x 100 (41141) / T15H x 100 (41142) /  
 T20H x 100 (41143) / T25H x 125 (41144)
- Screwdriver SoftFinish® electric Hex nut driver, VDE and GS tested / 5,5 x 125 (00856) / 7 x 125 (00858) / 8 x 125 (00859) / 10 x 125 (00861) /  
 13 x 125 (00864)
- ⊕ Fine screwdriver PicoFinish electric Phillips, VDE and GS tested / PH0 x 60 (38880)
- ⊖ Fine screwdriver PicoFinish electric Slotted, VDE and GS tested / 2,5 x 60 (38876)
- ⊖ ⊕ ⊕ ⊕ ⊕ Switch cabinet key pen shape 1/4" in blister pack 5-8 x 9 (39076)
- ⊖ Screwdriver SoftFinish® Slotted with one-piece hexagonal blade and solid steel cap 3,5 x 75 (03223) / 12,0 x 200 (03231)
- XLSelector Y bit set, 25 mm (41832)
- ⊕ ⊕ ⊕ 1 x PH1 / 4 x PH2 / 1 x PH3 / 2 x PZ1 / 4 x PZ2 / 2 x PZ3 / 2 x T10 / 3 x T15 / 3 x T20 / 3 x T25 / 3 x T30 / 2 x T40 / 1 x Bit holder  
 magnetic extra strong magnet, 1/4"
- L-key set in ErgoStar holder (41979)  
 1,5 / 2 / 2,5 / 3 / 4 / 5 / 6 / 8 / 10





### Trimming / cutting

-  Professional BiCut® high-performance diagonal cutters with DynamicJoint® Switchable, VDE and GS tested / 200mm, 8" (38191)
-  Professional electric diagonal cutters with DynamicJoint® 160 x 6 1/2" (43335)
-  Cable cutter Professional electric, VDE and GS tested / 200mm, 8" (34744)
-  Precision mechanic's diagonal cutters Classic with opening spring 125mm, 5" (36189)







### Supplying / holding

-  Combination pliers Professional electric with DynamicJoint® and OptiGrip with extra long cutting edge, VDE and GS tested / 180mm, 7" (26708)
-  Needle nose pliers Professional electric with cutting edge curved shape, approx. 40°, VDE and GS tested / 200mm, 8" (26729)
-  Needle nose pliers Professional electric with cutting edge straight shape, VDE and GS tested / 200mm, 8" (26727)
-  Water pump pliers Professional electric with push button adjustment, VDE and GS tested / 250mm, 10" (37450)

### Stripping/ insulating / crimping

-  Installation pliers TriCut Professional electric 170mm, 7" (38552)
-  Stripping tool with self-rotating trailing blade 165mm, 6½" (35969)
-  Stripping tool automatic up to 16 mm² in blister pack 200mm, 8" (42062)
-  Automatic crimp tool for wire-end sleeves hex crimping 210mm, 0,08-16mm² (41246)
-  Crimp tool for insulated cable eyes and contacts 220mm, 0,5-6mm² (33841)
-  Shear for electricians with crimp function in blister pack 160mm, 50mm² (41923)

### Surveying/marketing/measuring/checking

-  Single-pole, non-contact volt detector, 90–1,000 VAC Includes two AAA batteries (43798)
-  Voltage tester SoftFinish® single-pole, 110-250 volts Slotted transparent, with push-on clip (34745)
-  Flashlight with LED, laser and UV light in blister pack, including 3 AAA batteries 100 / 310 lm x 390 - 400 nm (41286)
-  Electrician's spirit level 40 cm (42074)
-  Electrician's Longlife® folding ruler, 2 m metric, 10 segments (42068)
-  SoftFinish® dowel ratchet set with dowels (41289)
-  1 x Dowel ratchet Phillips / 2 x 30 / 2 x 40

### Striking/ chiselling

-  Electrician's hammer with 300 g hammer head, in blister pack 23,9 x 283 (42071)





assorted 80-pcs. in case

9300-702

Order-No.

40523



1

**Fastening / jamming**

- Screwdriver SoftFinish® electric Hex nut driver, VDE and GS tested / 5,5 x 125 (00856) / 7 x 125 (00858) / 8 x 125 (00859) / 10 x 125 (00861)
- ⊖ Screwdriver SoftFinish® electric slimFix Slotted, VDE and GS tested / 3,5 x 100 (35446) / 4,0 x 100 (35390) / 5,5 x 125 (35391) / 6,5 x 150 (35392)
- ⊕ Screwdriver SoftFinish® electric slimFix electric PlusMinus/Phillips, VDE and GS tested / SL/PH1 x 80 (35502) / SL/PH2 x 100 (35503)
- ⊕ Screwdriver SoftFinish® electric slimFix PlusMinus/Pozidriv, VDE and GS tested / SL/PZ1 x 80 (36329) / SL/PZ2 x 100 (36330)
- ⊕ Screwdriver SoftFinish® electric slimFix Phillips, VDE and GS tested / PH1 x 80 (35393) / PH2 x 100 (35394)
- ⊕ Screwdriver SoftFinish® electric slimFix Pozidriv, VDE and GS tested / PZ1 x 80 (35395) / PZ2 x 100 (35396)
- ⊖ Screwdriver SoftFinish® Slotted with one-piece hexagonal blade and solid steel cap 12,0 x 200 (03231)
- ⊕ ⊖ ⊕ ⊖ ⊕ ⊖ Switch cabinet key cross shape (36114)
- ⊕ ⊕ ⊕ Screwdriver with bit magazine LiftUp electric (38611)  
1 x 3,0 / 1 x 4,0 / 1 x 5,5 / 1 x PH1 / 1 x PH2 / 1 x SL/PZ2
- L-key set in Compact holder (01418)  
1,5 / 2 / 2,5 / 3 / 4 / 5 / 6 / 8 / 10
- Bit set XLSelector Standard 25 mm (29417)
- ⊕ ⊕ ⊕ ⊕ 1 x 4,5 / 1 x 5,5 / 1 x 6,5 / 2 x PH1 / 4 x PH2 / 1 x PH3 / 2 x PZ1 / 5 x PZ2 / 1 x PZ3 / 2 x T10 / 2 x T15 / 2 x T20 / 3 x T25 / 2 x T30 / 1 x T40 / 1 x Bit holder magnetic, 58 mm 1/4"

**Trimming / cutting**

- ⚡ Professional BiCut® high-performance diagonal cutters with DynamicJoint® Switchable, VDE and GS tested / 200mm, 8" (38191)
- ⚡ Precision mechanic's diagonal cutters Classic with opening spring 125mm, 5" (36189)

**Supplying / holding**

- Water pump pliers Professional electric with push button adjustment, VDE and GS tested / 250mm, 10" (37450)
- Needle nose pliers Professional electric with cutting edge curved shape, approx. 40°, VDE and GS tested / 200mm, 8" (26729)
- Combination pliers Professional electric with DynamicJoint® and OptiGrip with extra long cutting edge, VDE and GS tested / 180mm, 7" (26708)

- Needle nose pliers Professional electric with cutting edge straight shape, VDE and GS tested / 200mm, 8" (26727)

**Stripping/ insulating / crimping**

- ✂ Installation pliers TriCut Professional electric 170mm, 7" (38552)
- Stripping tool automatic up to 6 mm<sup>2</sup> in blister pack 190mm, 7 ½" (36050)
- Stripping tool with self-rotating trailing blade 165mm, 6½" (35969)
- Crimp tool for wire-end sleeves 220mm, 0,14-16mm<sup>2</sup> (33844)

**Surveying/marketing/measuring/checking**

- Single-pole, non-contact volt detector, 90–1,000 VAC Includes two AAA batteries (43798)
- ⊖ Voltage tester SoftFinish® single-pole, 110-250 volts Slotted transparent, with push-on clip (34745)
- Folding ruler Longlife 2 m metric, 10 segments (27057)
- Switch cabinet spirit level 20 cm (36859)



**INFOBOX:  
VDE-certified tools**



Wiha VDE-tested tools are subject to stringent safety test procedures.

All tools with the special marking have been tested at 10,000 V AC and are therefore approved for use at 1,000 V AC and 1,500 V DC.

The following equipment is required for all work on or around live components and should be appropriate for the specific task

- insulating personal protective equipment
- insulating safety mechanisms
- insulated tools

Before starting work, you must disconnect all active, live components of electrical machines and equipment and ensure that they remain disconnected while you carry out the work. This is achieved by complying with the five safety rules:

- disconnect
- secure against reconnection
- ensure power is switched off
- earth and short-circuit
- cover or block off adjacent live components

Certified by the VDE Testing and Certification Institute and individually tested according to the international standard IEC 60900.



**assorted 29-pcs. in bag**

9300-040

Order-No. 43879 1

**Fastening / jamming**

- ⊖ Screwdriver SoftFinish® electric slimFix Slotted, VDE and GS tested / 3,5 x 100 (35446) / 5,5 x 125 (35391)
- ⊕ Screwdriver SoftFinish® electric slimFix Phillips, VDE and GS tested / PH1 x 80 (35393) / PH2 x 100 (35394)
- ⊕ Screwdriver SoftFinish® electric slimFix Pozidriv, VDE and GS tested / PZ1 x 80 (35395) / PZ2 x 100 (35396)
- ⊖ PicoFinish® fine screwdriver Slotted 1,5 x 40 (42384) / 2,0 x 40 (42388) / 2,5 x 50 (42391) / 3,0 x 50 (42394)
- ⊕ PicoFinish® fine screwdriver Phillips PH00 x 40 (42402) / PH0 x 50 (42401)
- ⊖ ⊕ ⊖ ⊕ ⊖ Switch cabinet key cross shape (36114)
- L-key set in Compact holder (01418)  
1,5 / 2 / 2,5 / 3 / 4 / 5 / 6 / 8 / 10

**Trimming / cutting**

- ⌘ Diagonal cutters Electronic wide, pointed head without bevelled edge 130mm, 5 1/2" (26818)

**Supplying / holding**

- Needle nose pliers Professional electric with cutting edge straight shape, VDE and GS tested / 200mm, 8" (26727)
- Needle nose pliers Electronic narrow, short head straight form 150mm, 6" (26801)

**Stripping/ insulating / crimping**

- Stripping tool with self-rotating trailing blade 165mm, 6 1/2" (35969)
- Stripping tool automatic up to 6 mm² in blister pack 190mm, 7 1/2" (36050)

**Surveying/marketing/measuring/checking**

- ⊖ Voltage tester SoftFinish® single-pole, 110-250 volts Slotted transparent, with push-on clip (34745)

Tool set slimVario® electric

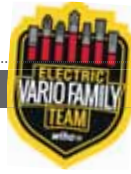

Tool set electrician



mixed, 31-pcs. in functional bag

7209N

Order-No.	
43465	1
⊖	2,0 x 75 / 3,5 x 75 / 5,5 x 75 / 6,5 x 75
⊕	PH0 x 75 / PH1 x 75 / PH2 x 75
⊗	SL/PZ1 x 75 / SL/PZ2 x 75
⊕	PZ1 x 75 / PZ2 x 75
○	5 x 42 / 5,5 x 42 / 6 x 42 / 7 x 42 / 8 x 42 / 10 x 42 / 11 x 42 / 13 x 42
●	3 x 75 / 4 x 75 / 5 x 75
⊗	T10 x 75 / T15 x 75 / T20 x 75 / T25 x 75
	slimVario® electric adapter for 1/4" nut driver
	Extension slimVario® electric for slimBits
	Screwdriver with bit holder SoftFinish® slimVario® electric / Fine screwdriver PicoFinish® slimVario® electric
○	Screwdriver with bit holder SoftFinish® electric slimVario Stubby for slimBits, VDE and GS tested
Manufactured acc. to IEC 60900.	

Mixed, 31-pcs. in tool pouch

9300-035

Order-No.	
41241	1
<b>Fastening / jamming</b>	
⊖	Screwdriver SoftFinish® electric slimFix Slotted, VDE and GS tested / 3,5 x 100 (35446) / 5,5 x 125 (35391)
⊕	Screwdriver SoftFinish® electric slimFix Phillips, VDE and GS tested / PH1 x 80 (35393) / PH2 x 100 (35394)
	Screwdriver with bit magazine magnetic (32901)
⊖ ⊕ ⊗ ⊕	1 x 6,5 / 1 x PH1 / 1 x PH2 / 1 x PH3 / 1 x PZ2 / 1 x T15 / 1 x T20 / 1 x T25
	Bit set FlipSelector Standard 25 mm (39040)
⊕ ⊗ ⊕	1 x PH2 / 1 x PZ1 / 1 x PZ2 / 1 x PZ3 / 1 x T10 / 1 x T15 / 1 x T20 / 1 x T25 / 1 x T30 / 1 x T40 / 1 x Bit holder magnetic, 58 mm 1/4"
<b>Supplying / holding</b>	
	Combination pliers Professional electric with DynamicJoint® and OptiGrip with extra long cutting edge, VDE and GS tested / 180mm, 7" (26708)
<b>Stripping/ insulating / crimping</b>	
	Stripping tool automatic up to 6 mm² in blister pack 190mm, 7 1/2" (36050)
<b>Surveying/markings/measuring/checking</b>	
⊖	Voltage tester SoftFinish® single-pole, 110-250 volts Slotted transparent, with push-on clip (34745)
	Folding ruler Longlife 2 m metric, 10 segments (27057)



**Mixed, 12-pcs. in tool pouch**

9300-025

Order-No.  36389 1

**Fastening / jamming**

- ⊖ Screwdriver SoftFinish® electric slimFix Slotted, VDE and GS tested / 3,5 x 100 (35446) / 4,5 x 125 (35501) / 5,5 x 125 (35391)
- ⊕ Screwdriver SoftFinish® electric slimFix Pozidriv, VDE and GS tested / PZ1 x 80 (35395) / PZ2 x 100 (35396)

**Trimming / cutting**

- ✂ Cable cutter Professional electric, VDE and GS tested / 200mm, 8" (34744)

**Supplying / holding**

- Needle nose pliers Professional electric with cutting edge straight shape, VDE and GS tested / 200mm, 8" (26727)
- ⚡ Heavy-duty diagonal cutters Professional electric with DynamicJoint® with switchable opening spring 180mm, 7" (41274)

**Stripping/ insulating / crimping**

- Stripping tool automatic up to 6 mm<sup>2</sup> in blister pack 190mm, 7 1/2" (36050)
- Stripping tool with self-rotating trailing blade 165mm, 6 1/2" (35969)

**Surveying/markings/measuring/checking**

- ⊖ Voltage tester SoftFinish® single-pole, 110-250 volts Slotted transparent, with push-on clip (34745)
- Folding ruler Longlife 2 m metric, 10 segments (27057)



**Screwdriver, heavy-duty diagonal cutters, 7-pcs. in tool pouch**

9300-031

Order-No.  38020 1

**Fastening / jamming**

- ⊖ Screwdriver SoftFinish® electric slimFix Slotted, VDE and GS tested / 3,5 x 100 (35446) / 4,0 x 100 (35390) / 5,5 x 125 (35391)
- ⊕ Screwdriver SoftFinish® electric slimFix Phillips, VDE and GS tested / PH2 x 100 (35394)
- ⊕ Screwdriver SoftFinish® electric slimFix Pozidriv, VDE and GS tested / PZ2 x 100 (35396)
- ⊕ Screwdriver SoftFinish® electric slimFix PlusMinus/Pozidriv, VDE and GS tested / SL/PZ2 x 100 (36330)

**Supplying / holding**

- ⚡ Heavy-duty diagonal cutters Professional electric with DynamicJoint® with switchable opening spring 160mm, 6,5" (40921)

**INFOBOX: DynamicJoint®**



**Wiha DynamicJoint® – A new dimension in strength and durability**

- Innovative: Optimised joint construction.
- Effective: Minimal power loss means less force needed for cutting.
- Permanent: Optimal performance even after thousands of cuts.



Tool set electrician



Screwdriver, diagonal cutters, 6-pcs. in tool pouch

9300-018

Order-No.  33969  1

Fastening / jamming

- ⊖ Screwdriver SoftFinish® electric Slotted, VDE and GS tested / 3,5 x 100 (00822) / 4,5 x 125 (00824) / 5,5 x 125 (00826)
- ⊕ Screwdriver SoftFinish® electric Phillips, VDE and GS tested / PH1 x 80 (00847) / PH2 x 100 (00848)

Tool set electrician



Screwdriver, needle nose pliers, diagonal cutters, 5-pcs. in tool pouch

9300

Order-No.  26755  1

Fastening / jamming

- ⊖ Screwdriver SoftFinish® electric Slotted, VDE and GS tested / 3,5 x 100 (00822) / 5,5 x 125 (00826)
- ⊕ Screwdriver SoftFinish® electric Phillips, VDE and GS tested / PH2 x 100 (00848)

Supplying / holding

- Needle nose pliers Professional electric with cutting edge straight shape, VDE and GS tested / 200mm, 8" (26727)

Bit set for mounting



19-pcs. in roll-up bag

79187 T04

Order-No.  41223  1

- ⊕ 1 x T15 / 1 x T20 / 1 x T25 / 1 x T30 / 1 x T40
- ⊕ 1 x PH0 / 1 x PH1 / 1 x PH2
- ⊕ 1 x SL/PZ1 / 1 x SL/PZ2
- ⊖ 1 x 3,5 / 1 x 4,0 / 1 x 5,5
- 1 x 4,0 / 1 x 5,0 / 1 x 6,0
- 1 x Bit holder magnetic, 74 mm 1/4"
- 1 x Screwdriver handle SoftFinish®-telescopic for SYSTEM 6 interchangeable blade
- 1 x Bit holder SYSTEM 6 clamping with ball

Tool set electrician



assorted slotted, Phillips, 10-pcs. in belt pouch

9300-012-01

Order-No.	
40948	1

**Fastening / jamming**

- ⊖ Screwdriver SoftFinish® electric slimFix Slotted, VDE and GS tested / 3,5 x 100 (35446) / 4,0 x 100 (35390) / 5,5 x 125 (35391)
- ⊕ Screwdriver SoftFinish® electric slimFix Phillips, VDE and GS tested / PH1 x 80 (35393) / PH2 x 100 (35394)

**Stripping/ insulating / crimping**

- ⊠ Stripping pliers Professional electric 160mm, 6 1/2" (26847)
- Stripping tool with self-rotating trailing blade 165mm, 6 1/2" (35969)

**Supplying / holding**

- Needle nose pliers Professional electric with cutting edge straight shape, VDE and GS tested / 200mm, 8" (26727)

**Surveying/markings/measuring/checking**

- ⊖ Voltage tester SoftFinish® single-pole, 110-250 volts Slotted transparent, with push-on clip (34745)
- Measuring tape 5 m (33251)

Tool set electrician



assorted slotted, Pozidriv, 10-pcs. in belt pouch

9300-013-02

Order-No.	
40282	1

**Fastening / jamming**

- ⊖ Screwdriver SoftFinish® electric slimFix Slotted, VDE and GS tested / 3,5 x 100 (35446) / 4,0 x 100 (35390) / 5,5 x 125 (35391)
- ⊕ Screwdriver SoftFinish® electric slimFix Pozidriv, VDE and GS tested / PZ1 x 80 (35395) / PZ2 x 100 (35396)

**Stripping/ insulating / crimping**

- ⊠ Stripping pliers Professional electric 160mm, 6 1/2" (26847)
- Stripping tool with self-rotating trailing blade 165mm, 6 1/2" (35969)

**Supplying / holding**

- Needle nose pliers Professional electric with cutting edge straight shape, VDE and GS tested / 200mm, 8" (26727)

**Surveying/markings/measuring/checking**

- ⊖ Voltage tester SoftFinish® single-pole, 110-250 volts Slotted transparent, with push-on clip (34745)
- Measuring tape 5 m (33251)

INFOBOX:  
slimTECHNOLOGY

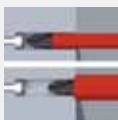

**Wiha SoftFinish® electric slimFix**

- Unlimited access.
- Blades up to 33 % narrower due to integrated insulation.
- Tool for spring clips (wedge-profiled output geometry).

Ratchet wrench set insulated 1/2"



20-pcs. in case

7208N

Order-No.	
43024	1
T-handle insulated for nut driver (43063)	
Ratchet wrench insulated for nut drivers Switchable 1/2" x 250 mm (43053)	
<input type="radio"/>	Insulated extension 1/2" square adapter for nut driver inserts, insulated 1/2" x 250 mm (43056) / 1/2" x 125 mm (43055)
<input type="radio"/>	Insulated nut driver insert 1/2" hexagon head 10 / 11 / 12 / 13 / 14 / 17 / 19 / 22 / 24 / 27 / 32
<input checked="" type="radio"/>	Insulated nut driver insert 1/2" internal hexagon 4 x 120 mm (43100) / 5 x 120 mm (43101) / 6 x 120 mm (43102) / 8 x 120 mm (43103) / 10 x 120 mm (43104)

Manufactured according to EN/IEC 60900.

Ratchet wrench set insulated 3/8"



20-pcs. in case

7207NK2001

Order-No.	
43023	1
T-handle insulated for nut driver (43062)	
Ratchet wrench insulated for nut drivers Switchable 3/8" x 200 mm (43052)	
<input type="radio"/>	Insulated extension 3/8" square adapter for nut driver inserts, insulated 3/8" x 125 mm (43057) / 3/8" x 250 mm (43058)
<input type="radio"/>	Insulated nut driver insert 3/8" hexagon head 8 / 10 / 11 / 12 / 13 / 14 / 16 / 17 / 18 / 19 / 21 / 22
<input checked="" type="radio"/>	Insulated nut driver insert 3/8" internal hexagon 4 x 75 mm (43105) / 5 x 75 mm (43106) / 6 x 75 mm (43107) / 8 x 75 mm (43108)

Manufactured according to EN/IEC 60900.



Single open-end spanner set, insulated 6-32 mm



20-pcs. in case

5590N T20

Order-No.			
43022		1	
○	Single, insulated open-end spanner		
○	6 / 7 / 8 / 9 / 10 / 11 / 12 / 13 / 14 / 15 / 16 / 17 / 18 / 19 / 22 / 24 / 27 / 30 / 32		
○	Adjustable spanner electric Adjustable between 0-30 mm 0 - 30 x 250 mm (43061)		

Manufactured according to EN/IEC 60900.

Single, insulated open-end spanner



Order-No.	○	mm		5590N
43026	6	90		1
43027	7	90		1
43028	8	100		1
43029	9	100		1
43030	10	110		1
43031	11	110		1
43032	12	130		1
43033	13	135		1
43034	14	145		1
43035	15	150		1
43036	16	160		1
43037	17	160		1
43038	18	175		1
43039	19	175		1
43040	22	195		1
43041	24	225		1
43042	27	250		1
43043	30	290		1
43044	32	310		1

Manufactured according to EN/IEC 60900.

Adjustable spanner electric



Order-No.	○	mm		5590NA
43061	0 - 30	250		1

Manufactured according to EN/IEC 60900.

T-handle insulated for nut driver



24618T

Order-No.	■	↑	mm	🔌
43063	1/2"	200		10
43062	3/8"	200		10

Manufactured according to EN/IEC 60900.

Insulated nut driver insert



○ 1/4" hexagon head

7209NS

Order-No.	○	←	mm	🔌
43088	4	42		1
43089	5	42		1
43090	5,5	42		1
43091	6	42		1
43092	7	42		1
43093	8	42		1
43094	9	42		1
43095	10	42		1
43096	11	42		1
43097	12	42		1
43098	13	42		1
43099	14	42		1

Manufactured according to EN/IEC 60900.

Insulated nut driver insert



○ 3/8" hexagon head

7207NS

Order-No.	○	←	mm	🔌
43065	8	45		1
43066	10	45		1
43067	11	45		1
43068	12	45		1
43069	13	45		1
43070	14	45		1
43071	16	45		1
43072	17	45		1
43073	18	45		1
43074	19	47		1
43075	21	47		1
43076	22	47		1

Manufactured according to EN/IEC 60900.

Insulated nut driver insert



○ 1/2" hexagon head

7208NS

Order-No.	○	←	mm	🔌
43077	10	55		1
43078	11	55		1
43079	12	55		1
43080	13	55		1
43081	14	55		1
43082	17	55		1
43083	19	55		1
43084	22	55		1
43085	24	55		1
43086	27	55		1
43087	32	55		1

Manufactured according to EN/IEC 60900.

### Insulated extension



#### ○ 1/2" square adapter for nut driver inserts, insulated

7208NEX

Order-No.	■	↑	mm	↔	📦
43055	1/2"		125		1
43056	1/2"		250		1

Manufactured according to EN/IEC 60900.

#### ○ 3/8" square adapter for nut driver inserts, insulated

7207NEX

Order-No.	■	↑	mm	↔	📦
43057	3/8"		125		1
43058	3/8"		250		1

Manufactured according to EN/IEC 60900.

### Insulated nut driver insert



#### ● 1/2" internal hexagon

7208NHS

Order-No.	●	mm	↔	📦
43100	4	120		1
43101	5	120		1
43102	6	120		1
43103	8	120		1
43104	10	120		1

Manufactured according to EN/IEC 60900.

### Insulated nut driver insert



#### ● 3/8" internal hexagon

7207NHS

Order-No.	●	mm	↔	📦
43105	4	75		1
43106	5	75		1
43107	6	75		1
43108	8	75		1

Manufactured according to EN/IEC 60900.

### Ratchet wrench insulated for nut drivers



#### Switchable

7207NRW

Order-No.	■	↑	mm	↔	📦
43052	3/8"		200		1
43053	1/2"		250		1

Manufactured according to EN/IEC 60900.



Mixed, 31-pcs. in tool pouch

9300-026

Order-No.	Icon	Quantity
36390	☒	1
⊖	Screwdriver SoftFinish® Slotted with round blade and lasered mm scale 4,0 x 100 (36085) / 5,5 x 125 (35397)	
⊕	Screwdriver SoftFinish® Phillips with round blade and lasered mm scale PH1 x 80 (36072) / PH2 x 100 (35398)	
○	Screwdriver with T-handle and two bit holders ComfortGrip magnetic 1/4" 1/4 x 150 (26179)	
	High-leverage combination pliers Professional with DynamicJoint® and OptiGrip with extra long cutting edge 200mm, 8" (26713)	
⚡	Heavy-duty diagonal cutters Professional with DynamicJoint® with switchable opening spring 180mm, 7" (41273)	
	Water pump pliers Classic with push button 250mm, 10" (26765)	
	Folding ruler Longlife 2 m metric, 10 segments (27057)	
⊕ ⊕ ⊕	Bit set FlipSelector Standard 25 mm (39040) 2 x PH2 / 1 x PZ1 / 2 x PZ2 / 1 x PZ3 / 1 x T10 / 1 x T15 / 1 x T20 / 1 x T25 / 1 x T30 / 1 x T40 / 1 x Bit holder magnetic, 58 mm 1/4"	
●	L-key set in ErgoStar holder (37351) 1,5 / 2 / 2,5 / 3 / 4 / 5 / 6 / 8 / 10	



assorti 30-delig in gereedschapetui

9300-024

Order-No.	Icon	Quantity
36388	☒	1
⊖	Screwdriver SoftFinish® Slotted with round blade for low-lying screws 3,0 x 100 (00687) / 5,5 x 125 (00698)	
⊕	Screwdriver SoftFinish® Phillips with round blade PH1 x 80 (00756) / PH2 x 100 (00759)	
○	Screwdriver with T-handle and bit holder magnetic 1/4" 1/4 x 150 (01481)	
	Water pump pliers Classic box type 250mm, 10" (26761)	
	Folding ruler Longlife 2 m metric, 10 segments (27057)	
⊕ ⊕ ⊕	Bit set FlipSelector Standard 25 mm (39040) 2 x PH2 / 1 x PZ1 / 2 x PZ2 / 1 x PZ3 / 1 x T10 / 1 x T15 / 1 x T20 / 1 x T25 / 1 x T30 / 1 x T40 / 1 x Bit holder magnetic, 58 mm 1/4"	
●	L-key set in Compact holder (01222) 1,5 / 2 / 2,5 / 3 / 4 / 5 / 6 / 8 / 10	

INFOBOX:

OptiGrip



Wiha OptiGrip – optimal grip due to newly designed gripping surfaces

- A firm hold: The „triple-point support“ protects the workpiece from twisting or slipping.
- Highly effective: Optimum grip even with large jaw opening – and at the same time significantly less force needed.
- A wide selection: Now in standard Wiha combination pliers and high leverage combination pliers.



**Screwdriver, combination pliers, 6-pcs. in tool pouch**

9300-019

Order-No.	
33970	1
⊖	Screwdriver SoftFinish® Slotted with round blade for low-lying screws 3,5 x 100 (00691) / 4,5 x 125 (00697)
⊖	Screwdriver SoftFinish® Slotted with round blade 6,5 x 150 (00703)
⊕	Screwdriver SoftFinish® Phillips with round blade PH1 x 80 (00756) / PH2 x 100 (00759)
	Combination pliers Professional with DynamicJoint® and OptiGrip with extra long cutting edge 180mm, 7" (26707)



**Screwdriver, diagonal cutters, 6-pcs. in tool pouch**

9300-020

Order-No.	
33971	1
⊖	Screwdriver SoftFinish® Slotted with round blade for low-lying screws 3,5 x 100 (00691) / 4,5 x 125 (00697)
⊖	Screwdriver SoftFinish® Slotted with round blade 6,5 x 150 (00703)
⊕	Screwdriver SoftFinish® Phillips with round blade PH1 x 80 (00756) / PH2 x 100 (00759)





**Screwdriver, diagonal cutters, combination pliers, 5-pcs. in tool pouch**

Z99000602

Order-No.	
30824	1
⊖	Screwdriver SoftFinish® Slotted with round blade for low-lying screws 3,5 x 100 (00691) / 5,5 x 125 (00698)
⊕	Screwdriver SoftFinish® Phillips with round blade PH2 x 100 (00759)
	Combination pliers Industrial with DynamicJoint® and OptiGrip with extra long cutting edge 180mm, 7" (30826)



**Pliers, screwdriver, tweezers, 9-pcs. in bag**

9300-041

Order-No.	
43994	1
⊖	Needle nose pliers Professional ESD straight 120 mm, 4 3/4" (26799)
⌄	Diagonal cutters Professional ESD wide, pointed head without bevelled edge 115mm, 4 1/2" (26821)
	Universal tweezers Professional ESD Type AA 130mm, AA (32318)
⊖	Fine screwdriver PicoFinish® ESD Slotted 2,0 x 0,4 (43670) / 2,5 x 0,4 (43671)
⊕	Fine screwdriver PicoFinish® ESD Phillips PH 0 x 50 (43677) / PH 00 x 40 (43676)
⊛	Fine screwdriver PicoFinish® ESD TORX® 5 x 40 (43698) / 6 x 40 (43699)

**INFOBOX: Electrostatic conductive ESD tools**

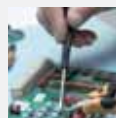

**Sensitive, electronic components can be damaged even at a very low voltage.**

- Dissipative tools by Wiha discharge the electrostatic energy in a controlled, safe manner.
- ESD tools meet the ESD Standard IEC 61340-5-1.
- ESD tool handles have a surface resistance of 10<sup>6</sup> -10<sup>9</sup> Ohm.



## **Electro**

### **Safety for professionals.**

With the speedE® e-screwdriver, Wiha is revolutionising the screwdriver market. Whether handling delicate fastenings, long screws or very many screws, professionals have no trouble working with the e-screwdriver. The material protection function in particular makes the speedE® unique: At 0.4 Nm the electrical assistance stops automatically and allows the user to finish tightening the screw carefully by hand. In combination with the VDE certified slimBits the speedE® offers electricians full protection during their daily work.

The swivelling Wiha flashlight features an integrated laser, UV light and LED light with two lighting levels.

With Torque QuickCheck, Wiha is bringing the first portable quick tester for regular checks on torque tools onto the market, thus guaranteeing safe and precise work.

**Application**      **Electro**

**Fastening**

**E-screwdriver, set 2, speedE®**  
Page 156



**speedE® Industrial e-screwdriver set**  
Page 159



**Surveying / marking**

**Flashlight with LED, laser and UV light**  
Page 160



**Testing**

**Single-pole, explosion-protected, non-contact volt detector, 12–1,000 V AC**  
Page 160



**Torque QuickCheck torque testing device**  
Page 161



E-screwdriver, set 1, speedE®



E-screwdriver, set 2, speedE®

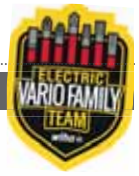

Slotted, Phillips, PlusMinus/Pozidriv, 10 pcs in L Boxx Mini with slimBits, batteries and EU charger

590

Order-No.		
41911	with USB and Europlug	1
42266	with USB and UK plug	1
E-screwdriver handle speedE®		
⊖	slimBit electric bit Slotted, VDE and GS tested / 3,5 x 75 (41159) / 5,5 x 75 (34581)	
⊕	slimBit electric bit Phillips, VDE and GS tested / PH1 x 75 (34583) / PH2 x 75 (34584)	
⊕	slimBit electric bit PlusMinus/Pozidriv, VDE and GS tested / SL/PZ1 x 75 (34589) / SL/PZ2 x 75 (34590)	
Battery set, 18500 Li-ion 2 units in box (41914)		
Charger for 18500 Li-ion batteries (41915)		

Mixed 13 pcs in L Boxx Mini with slimBits, easyTorque adapter, batteries and EU charger

590

Order-No.		
41912	with USB and Europlug	1
42267	with USB and UK plug	1
E-screwdriver handle speedE®		
⊖	slimBit electric bit Slotted, VDE and GS tested / 3,5 x 75 (41159) / 5,5 x 75 (34581)	
⊕	slimBit electric bit Phillips, VDE and GS tested / PH1 x 75 (34583) / PH2 x 75 (34584)	
⊕	slimBit electric bit Pozidriv, VDE and GS tested / PZ1 x 75 (34585) / PZ2 x 75 (34586)	
⊕	slimBit electric bit PlusMinus/Pozidriv, VDE and GS tested / SL/PZ1 x 75 (34589) / SL/PZ2 x 75 (34590)	
Torque adapter easyTorque electric for slimBits and slimVario® holder in blister 2,8 ± 10 % (41344)		
Battery set, 18500 Li-ion 2 units in box (41914)		
Charger for 18500 Li-ion batteries (41915)		

E-screwdriver, set 3, speedE®



Mixed 25 pcs in L Boxx Mini with slimBits, easyTorque adapters, batteries and EU charger

590

Order-No.		
41913	with USB and Europlug	1
42268	with USB and UK plug	1
E-screwdriver handle speedE®		
⊖	slimBit electric bit Slotted, VDE and GS tested / 3,5 x 75 (41159) / 5,5 x 75 (34581)	
⊕	slimBit electric bit Phillips, VDE and GS tested / PH1 x 75 (34583) / PH2 x 75 (34584)	
⊕	slimBit electric bit Pozidriv, VDE and GS tested / PZ1 x 75 (34585) / PZ2 x 75 (34586)	
⊕	slimBit electric bit PlusMinus/Pozidriv, VDE and GS tested / SL/PZ1 x 75 (34589) / SL/PZ2 x 75 (34590)	
⊗	slimBit electric bit TORX®, VDE and GS tested / T10 x 75 (35507) / T15 x 75 (35508) / T20 x 75 (35509) / T25 x 75 (36071)	
●	slimBit electric bit Hex, VDE and GS tested / 3 x 75 (37147) / 4 x 75 (37225) / 5 x 75 (37226) / 6 x 75 (37227)	
Torque adapter easyTorque electric for slimBits and slimVario® holder in blister		
0,8 ± 10 % (41341) / 2,0 ± 10 % (41342) / 2,5 ± 10 % (41343) / 2,8 ± 10 % (41344) / 4,0 ± 10 % (41345)		
Battery set, 18500 Li-ion 2 units in box (41914)		
Charger for 18500 Li-ion batteries (41915)		

INFOBOX:  
Wiha speedE®



E-screwdriver speedE®

- Power-assisted screw-driving halves working time.
- Thanks to the integrated material protection function, the electric assistance stops automatically at 0.4 Nm.
- Final screw tightening can then be carried out by hand.
- Recommended by doctors and therapists.
- slimBits tested at 10,000 V AC and approved for 1,000 V AC.

Charger for 18500 Li-ion batteries



with USB and Europlug

5992

Order-No.	
41915	1

Charger for 18500 Li-ion batteries



with USB and UK plug

5992

Order-No.	
42766	1

Battery set, 18500 Li-ion



2 units in box

5991

Order-No.	
41914	6



**TORX®, 5-pcs. with bit, battery and USB charger**

590

Order-No.		
43631		1
	E-screwdriver handle, speedE® Industrial	
	Bit holder with 50 mm bit T20	
	18500 Li-Ion battery	
	USB charger for 18500 Li-ion batteries	

**INFOBOX:  
Wiha speedE®  
Industrial**



**E-screwdriver speedE®**

- Recommended by doctors and therapists.
- Electric screw fastening with protection function to prevent damage to materials (max. 0.4 Nm).
- Fixing by hand with a deft touch.
- Work twice as fast thanks to three-step process.

Flashlight with LED, laser and UV light



in blister pack, including 3 AAA batteries

24670

Order-No.	LED	☼	UV	🔋	SB	📦
41286	100 / 310 lm	Class 2	390 - 400 nm	3 x AAA batteries	x	5

Single-pole, non-contact volt detector, 12–1,000 V AC

Single-pole, non-contact volt detector, 90–1,000 VAC



Includes two AAA batteries

25513

Order-No.	●	⚡	mm	📦
43797	2	28,5	150	

Includes two AAA batteries

25514

Order-No.	●	⚡	mm	📦
43798	2	28,5	150	5

INFOBOX:  
Volt Detector



Single-pole, non-contact volt detector, 12–1,000 V AC

- Rapid voltage test thanks to contactless measuring.
- Compatible for use in all sockets worldwide thanks to measurement tip suited to international usage.
- Voltage tester covers a wide voltage range between 12 and 1,000 V AC.





with adapter blades and batteries in box

2909

Order-No.	Nm	7/4%	SB	
42086	2,8	2	x	1

### INFOBOX: Flashlight with LED, laser and UV light



- Universal work tool with integrated laser, UV light and LED light.
- Optimum positioning and variable light direction thanks to the magnetic base and swivel head.
- The installation position can be projected directly from the middle of a table when fitting lights to the ceiling.
- The integrated UV light is ideal for finding misplaced coloured fluorescent Wiha tools and for technical inspections.

### INFOBOX: Torque QuickCheck



#### Wiha Torque QuickCheck

- The Wiha torque screwdriver can quickly and easily test torque screwdrivers to check the precision of the configured torque value before each use.
- Checking tools regularly ensures reliable, precise work.
- The device offers user-friendly operation, clear test readings and easy to understand LED traffic light signals.
- Thanks to a compact, handy shape, it is the ideal companion when out on jobs.
- Suitable for all Torque Vario®-S and iTorque® torque screwdrivers whose torque range included 2.8 Nm.



## **Screwdrivers**

### **We have the know-how at the tip of our fingers.**

Unlike many standard tools available on the market, Wiha screwdrivers are optimally designed for users' requirements. Thanks to Wiha's screwdriver handle size concept, four handle sizes and lengths, optimally adapted to their specific fastening or work task, ensure health-friendly work practices. With SoftFinish, Wiha became the world's first and only hand tool manufacturer to have products honoured with the renowned AGR quality seal - a seal of approval accepted by medical professionals and officially recommended by doctors and therapists. Wiha screwdrivers featuring SoftFinish are available for dry applications, damp and oily applications and as VDE-certified, insulated screwdrivers for use when working on live parts..

Wiha is the world's first hand tool manufacturer to receive AGR (Association for healthy backs) certification for its Inomic pliers and ergonomic screwdriver handle size concept, a seal of approval accepted by medical professionals and officially recommended by doctors and physiotherapists.

## Application

## Screwdrivers

For applications  
in electrics



**Screwdriver and bit set  
slimVario® screwdriver  
Mixed, 18-pcs. in folding  
bag**  
Page 164



**Screwdriver set  
SoftFinish® electric  
slimFix  
assorted 12-pcs.**  
Page 165

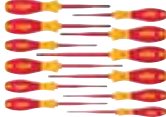

**Screwdriver set  
SoftFinish® electric  
slimFix**  
Page 166



**Screwdriver with bit  
holder set electric  
slimVario®, Stubby, 4  
pieces with slimBits**  
Page 167



**slimBit electric bit set**  
Page 168



**Screwdriver SoftFinish®  
electric slimFix**  
Page 172



**Screwdriver SoftFinish®  
electric**  
Page 173



**Fine screwdriver  
PicoFinish electric**  
Page 174



For applications  
in mechanics



**Screwdriver set  
SoftFinish®  
assorted 12-pcs.**  
Page 175



**Screwdriver set  
SoftFinish®**  
Page 175



**Screwdriver set  
SoftFinish®**  
Page 176



**Fine screwdriver set  
PicoFinish**  
Page 177



**Screwdriver SoftFinish®**  
Page 178



**Screwdriver SoftFinish®**  
Page 182



**Fine screwdriver  
PicoFinish**  
Page 184



**Screwdriver SoftFinish®**  
Page 183



**Screwdriver MicroFinish®**  
Page 187



**Screwdriver MicroFinish®**  
Page 187



**Screwdriver MicroFinish®**  
Page 187



**Screw extractor set  
Hex, 8-pcs. with spiral  
drill bit in box**  
Page 188



For applications  
in electronics



**Screwdriver set  
SoftFinish® ESD**  
Page 188



**Fine screwdriver set  
PicoFinish® ESD**  
Page 189



**Screwdriver SoftFinish®  
ESD**  
Page 189



Screwdriver and bit set slimVario® screwdriver

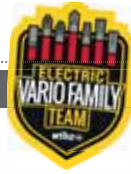

Mixed, 18-pcs. in folding bag

2831

Order-No.	
41231	1
○	Screwdriver with bit holder SoftFinish® electric slimVario Stubby for slimBits VDE and GS tested
○	Screwdriver with bit holder SoftFinish® electric slimVario for slimBits VDE and GS tested
⊖	2,5 x 75 / 3,5 x 75 / 5,5 x 75
⊕	PH1 x 75 / PH2 x 75
⊗	PZ1 x 75 / PZ2 x 75
⊗	SL/PZ1 x 75 / SL/PZ2 x 75
⊗	T9 x 75 / T10 x 75 / T15 x 75 / T20 x 75
●	3 x 75 / 4 x 75 / 5 x 75

Manufactured acc. to IEC 60900.

Screwdriver and bit set slimVario® screwdriver

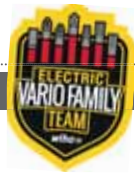

Slotted, Phillips, Pozidriv, 9-pcs. in folding bag

2831

Best.-Nr.	
41232	1
○	Screwdriver with bit holder SoftFinish® electric slimVario Stubby for slimBits VDE and GS tested
○	Screwdriver with bit holder SoftFinish® electric slimVario for slimBits VDE and GS tested
⊖	2,5 x 75 / 3,5 x 75 / 5,5 x 75
⊕	PH1 x 75 / PH2 x 75
⊗	PZ1 x 75 / PZ2 x 75

Manufactured acc. to IEC 60900.

Slotted, Pozidriv, PlusMinus/Pozidriv, 9-pcs. in folding bag

2831

Best.-Nr.	
41233	1
○	Screwdriver with bit holder SoftFinish® electric slimVario Stubby for slimBits VDE and GS tested
○	Screwdriver with bit holder SoftFinish® electric slimVario for slimBits VDE and GS tested
⊖	2,5 x 75 / 3,5 x 75 / 5,5 x 75
⊗	PZ1 x 75 / PZ2 x 75
⊗	SL/PZ1 x 75 / SL/PZ2 x 75

Manufactured acc. to IEC 60900.

INFOBOX:  
slimTECHNOLOGY

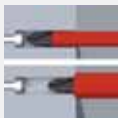

Wiha SoftFinish® electric slimFix

- Unlimited access.
- Blades up to 33 % narrower due to integrated insulation.
- Tool for spring clips (wedge-profiled output geometry).

Screwdriver set SoftFinish® electric slimFix

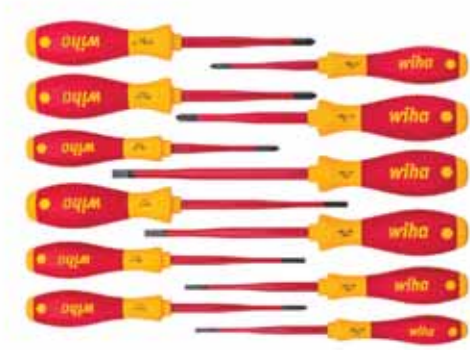

assorted 12-pcs.

3201

Order-No.	
41003	1
	3,5 x 100 / 4,0 x 100 / 5,5 x 125 / 6,5 x 150
	PH1 x 80 / PH2 x 100
	PZ1 x 80 / PZ2 x 100
	SL/PZ2 x 100
	T15 x 100 / T20 x 100 / T25 x 125

INFOBOX:  
Handle size concept



Wiha SoftFinish® handle sizes

- Every Wiha handle optimally balances guidance, speed and torque for the respective fastening task.
- Quick-turning - Motor skills are consistently taken into consideration.
- Maximum power transmission: comfortable and loss-free transmission of physical strength, even during intensive fastening.
- The power-turning and quick-turning zones vary significantly over the four handle sizes in various forms.
- The Wiha SoftFinish screwdrivers enable work that is kind on the hands and muscles and is therefore recommended by doctors and therapists from the AGR.

INFOBOX:  
VDE-certified tools



Wiha VDE-tested tools are subject to stringent safety test procedures.

All tools with the special marking have been tested at 10,000 V AC and are therefore approved for use at 1,000 V AC and 1,500 V DC.

The following equipment is required for all work on or around live components and should be appropriate for the specific task

- insulating personal protective equipment
- insulating safety mechanisms
- insulated tools

Before starting work, you must disconnect all active, live components of electrical machines and equipment and ensure that they remain disconnected while you carry out the work.

This is achieved by complying with the five safety rules:

- disconnect
- secure against reconnection
- ensure power is switched off
- earth and short-circuit
- cover or block off adjacent live components

Certified by the VDE Testing and Certification Institute and individually tested according to the international standard IEC 60900.

**Screwdriver set SoftFinish® electric slimFix**



**Slotted, Phillips 6-pcs. 3201**

Best.-Nr.	
35389	1
⊖	3,5 x 100 / 4,0 x 100 / 5,5 x 125 / 6,5 x 150
⊕	PH1 x 80 / PH2 x 100
Manufactured acc. to IEC 60900.	

**Slotted, Phillips, PlusMinus/Pozidriv 6-pcs. 3201**

Best.-Nr.	
38362	1
⊖	3,5 x 100 / 4,0 x 100 / 5,5 x 125
⊕	PH1 x 80 / PH2 x 100
⊗	SL/PZ2 x 100
Manufactured acc. to IEC 60900.	

**Slotted, Pozidriv 6-pcs. 3201**

Best.-Nr.	
36455	1
⊖	3,5 x 100 / 4,0 x 100 / 5,5 x 125 / 6,5 x 150
⊕	PZ1 x 80 / PZ2 x 100
Manufactured acc. to IEC 60900.	

**TORX® Tamper Resistant (with hole) 6-pcs. 3251TR**

Best.-Nr.	
41245	1
⊗	T10H x 100 / T15H x 100 / T20H x 100 / T25H x 125 / T30H x 125 / T40H x 150
Manufactured acc. to IEC 60900.	

**TORX® 6-pcs. 3251**

Best.-Nr.	
36558	1
⊗	T8 x 60 / T9 x 60
⊗	T10 x 100 / T15 x 100 / T20 x 100 / T25 x 125
• no slim version Manufactured acc. to IEC 60900.	

**Screwdriver set SoftFinish® electric slimFix**



**Slotted, PlusMinus/Pozidriv, 2-pcs. in blister pack 3201**

Best.-Nr.	
36333	1
⊖	3,5 x 100
⊕	SL/PZ2 x 100
Manufactured acc. to IEC 60900.	

**Screwdriver set SoftFinish® electric**



**Slotted, Phillips 7-pcs. 320N**

Best.-Nr.	
00834	1
⊖	2,5 x 75 / 4,0 x 100 / 5,5 x 125 / 6,5 x 150
⊕	PH1 x 80 / PH2 x 100
⊖	Voltage tester SoftFinish® single-pole, 110-250 volts Slotted transparent, with push-on clip
Manufactured acc. to IEC 60900.	

**Slotted, Phillips 6-pcs. 320N**

Best.-Nr.	
00833	10
⊖	3,0 x 100 / 4,0 x 100 / 5,5 x 125 / 6,5 x 150
⊕	PH1 x 80 / PH2 x 100
Manufactured acc. to IEC 60900.	

**Slotted, Pozidriv 6-pcs. 320N**

Best.-Nr.	
25477	1
⊖	2,5 x 75 / 3,5 x 100 / 4,5 x 125 / 5,5 x 125
⊕	PZ1 x 80 / PZ2 x 100
Manufactured acc. to IEC 60900.	

Screwdriver set SoftFinish® electric



PlusMinus/Phillips in blister pack 2-pcs.

327

Best.-Nr.  32281 1

 SL/PH1 x 80 / SL/PH2 x 100  
Manufactured acc. to IEC 60900.

PlusMinus/Pozidriv, 2-pcs. in blister pack

328

Best.-Nr.  32282 1

 SL/PZ1 x 80 / SL/PZ2 x 100  
Manufactured acc. to IEC 60900.

Screwdriver set SoftFinish® electric



Hexagon nut driver 5-pcs.

322 K5

Order-No.  29466 1

 5,5 x 125 / 7 x 125 / 8 x 125 / 10 x 125 / 13 x 125  
Manufactured acc. to IEC 60900.

INFOBOX:  
Combination profiles



PlusMinus.

- The special PlusMinus/Pozidriv profile is ideal for PlusMinus terminal screws.
- The combination profile reduces slipping out and guarantees a higher torque transmission.

Screwdriver with bit holder set electric slimVario®



Stubby, 4 pieces with slimBits

2831

Order-No.  41230 1

- Screwdriver with bit holder SoftFinish® electric slimVario Stubby for slimBitsVDE and GS tested
- ⊖ 3,5 x 75
- ⊕ PH2 x 75
- ⊕ SL/PZ2 x 75

Manufactured acc. to IEC 60900.

Fine screwdriver set PicoFinish® slimVario® electric



4-pcs. with slimBits

2831

Order-No.  43167 5

- 1 x Fine screwdriver PicoFinish® slimVario® electric /
- ⊖ 1 x 2,0
- ⊕ 1 x PH0
- ⊕ 1 x PZ0

Manufactured acc. to IEC 60900.

Fine screwdriver set PicoFinish® electric



Slotted, Phillips, 6 pcs. with holder

2270P

Order-No.	
42989	1
	1,5 x 50 / 2,0 x 50 / 2,5 x 65 / 3 x 65
	PH00 x 50 / PH0 x 65

INFOBOX:  
PicoFinish electric



Wiha PicoFinish electric: The VDE-GS tested precision screwdriver.

- The smooth-running turn-cap enables fast turning.
- Imprint with the screw symbol and sizes eases recognition.

Screwdriver with bit holder SoftFinish® electric slimVario®



for slimBits

283100

Order-No.				mm		
34577	6	30	50	160	13	5

Manufactured acc. to IEC 60900.

slimBit electric bit set



TORX®, TORX PLUS®, 12-pcs. in SlimBit box

2831

Best.-Nr.	
43161	6
	6IP x 75 / 7IP x 75 / 8IP x 75 / 9IP x 75 / 10IP x 75 / 15IP x 75
	T6 x 75 / T7 x 75 / T8 x 75 / T9 x 75 / T10 x 75 / T15 x 75
	slimBit box empty, 2-pcs. with belt clip
	Manufactured acc. to IEC 60900.

Slotted, Phillips, Pozidriv, PlusMinus/Pozidriv, TORX® 12-pcs. in SlimBit box

2831

Best.-Nr.	
43162	6
	3,5 x 75 / 5,5 x 75
	PH1 x 75 / PH2 x 75
	PZ1 x 75 / PZ2 x 75
	SL/PZ1 x 75 / SL/PZ2 x 75
	T10 x 75 / T15 x 75 / T20 x 75 / T25 x 75
	slimBit box empty, 2-pcs. with belt clip
	Manufactured acc. to IEC 60900.



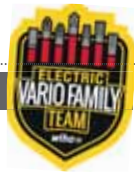

**Slotted, 6-pcs. in SlimBit box**

2831

Best.-Nr.	
43152	6
	2,0 x 75 / 2,5 x 75 / 3,5 x 75 / 4,0 x 75 / 5,5 x 75 / 6,5 x 75
Manufactured acc. to IEC 60900.	

**Slotted, Pozidriv 6-pcs. in SlimBit box**

2831

Best.-Nr.	
43157	6
	2,5 x 75 / 3,5 x 75 / 5,5 x 75 / 6,5 x 75
	PZ1 x 75 / PZ2 x 75
Manufactured acc. to IEC 60900.	

**TORX®, 6-pcs. in SlimBit box**

2831

Best.-Nr.	
43153	6
	T8 x 75 / T9 x 75 / T10 x 75 / T15 x 75 / T20 x 75 / T25 x 75
Manufactured acc. to IEC 60900.	

**Slotted, PlusMinus/Pozidriv 6-pcs. in SlimBit box**

2831

Best.-Nr.	
43158	6
	2,5 x 75 / 3,5 x 75 / 5,5 x 75 / 6,5 x 75
	SL/PZ1 x 75 / SL/PZ2 x 75
Manufactured acc. to IEC 60900.	

**TORX®, 6-pcs. in SlimBit box**

2831

Best.-Nr.	
43154	6
	T6 x 75 / T7 x 75 / T8 x 75 / T9 x 75 / T10 x 75 / T15 x 75
Manufactured acc. to IEC 60900.	

**Slotted, Phillips 6-pcs. in SlimBit box**

2831

Best.-Nr.	
43159	6
	2,5 x 75 / 3,5 x 75 / 5,5 x 75 / 6,5 x 75
	PH1 x 75 / PH2 x 75
Manufactured acc. to IEC 60900.	

**TORX PLUS®, 6-pcs. in SlimBit box**

2831

Best.-Nr.	
43155	6
	6IP x 75 / 7IP x 75 / 8IP x 75 / 9IP x 75 / 10IP x 75 / 15IP x 75
Manufactured acc. to IEC 60900.	

**Slotted, Phillips, Pozidriv 6-pcs. in SlimBit box**

2831

Best.-Nr.	
43160	6
	2,0 x 75 / 2,5 x 75
	PH0 x 75 / PH1 x 75
	PZ0 x 75 / PZ1 x 75
Manufactured acc. to IEC 60900.	

**Hex, 6-pcs. in SlimBit box**

2831

Best.-Nr.	
43156	6
	2 x 75 / 2,5 x 75 / 3 x 75 / 4 x 75 / 5 x 75 / 6 x 75
Manufactured acc. to IEC 60900.	

slimBit electric bit



Slotted

283110

Order-No.	⊖	mm	⊖	⊙	max. Nm	📦
43114	1,5•	75	0,4	6,0	0,4	5
43115	2,0•	75	0,4	6,0	0,4	5
34578	2,5•	75	0,4	6,0	0,4	5
34579	3,0•	75	0,5	6,0	0,6	5
41159	3,5	75	0,6	6,0	1,4	5
34580	4,0	75	0,8	6,0	2,5	5
34581	5,5	75	1,0	6,0	3,8	5
34582	6,5	75	1,2	6,0	5,5	5

• no slim version  
Manufactured acc. to IEC 60900.

Phillips

283111

Order-No.	⊕	mm	⊙	max. Nm	📦
43116	PH0•	75	6,0	0,4	5
34583	PH1	75	6,0	3,8	5
34584	PH2	75	6,0	5,5	5

Manufactured acc. to IEC 60900.

Pozidriv

283112

Order-No.	⊕	mm	⊙	max. Nm	📦
43117	PZO•	75	6,0	0,5	5
34585	PZ1	75	6,0	3,8	5
34586	PZ2	75	6,0	5,5	5

Manufactured acc. to IEC 60900.

PlusMinus/Phillips

283113

Order-No.	⊕	mm	⊙	max. Nm	📦
34587	SL/PH1	75	6,0	3,8	5
34588	SL/PH2	75	6,0	5,5	5

Manufactured acc. to IEC 60900.

PlusMinus/Pozidriv

283114

Order-No.	⊕	mm	⊙	max. Nm	📦
34589	SL/PZ1	75	6,0	3,8	5
34590	SL/PZ2	75	6,0	5,5	5

Manufactured acc. to IEC 60900.

TORX®

283115

Order-No.	⊕	mm	⊙	max. Nm	📦
43140	T5•	75	6,0	0,4	5
43141	T6•	75	6,0	0,4	5
43142	T7•	75	6,0	0,4	5
35506	T8•	75	6,0	1,3	5
41160	T9•	75	6,0	1,3	5
35507	T10•	75	6,0	3,8	5
35508	T15	75	6,0	5,0	5
35509	T20	75	6,0	5,5	5
36071	T25	75	6,0	5,5	5

• no slim version  
Manufactured acc. to IEC 60900.

TORX PLUS®

283116

Order-No.	⊕	mm	⊙	max. Nm	📦
43143	5IP•	75	6	0,5	5
43144	6IP•	75	6	0,8	5
43145	7IP•	75	6	1,3	5
43146	8IP•	75	6	2,0	5
43147	9IP•	75	6	3,0	5
43148	10IP•	75	6	4,5	5
43149	15IP	75	6	5,5	5
43150	20IP	75	6	5,5	5
43151	25IP	75	6	5,5	5

• no slim version  
Manufactured acc. to IEC 60900.

Hex

283118

Order-No.	⊙	mm	⊙	max. Nm	📦
37222	1,5•	75	6,0	0,9	5
37223	2•	75	6,0	1,8	5
37224	2,5	75	6,0	3,8	5
37147	3	75	6,0	5,5	5
37225	4	75	6,0	5,5	5
37226	5	75	6,0	5,5	5
37227	6	75	6,0	5,5	5

• no slim version  
Manufactured acc. to IEC 60900.

Square

283117

Order-No.	⊙	mm	⊙	max. Nm	📦	
35510	#1	2,3	75	6,0	5,5	5
35511	#2	2,8	75	6,0	5,5	5

Manufactured acc. to IEC 60900.



**empty, 2-pcs. with belt clip**

2831-B992

Order-No.



43164

6,00

2x slimBit box Empty

1x Belt holster for slimBit box, empty



**Empty**

Order-No.



43163

6



INFOBOX:  
**slimTECHNOLOGY**

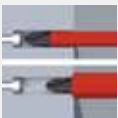

**Wiha SoftFinish® electric slimFix**

- Unlimited access.
- Blades up to 33 % narrower due to integrated insulation.
- Tool for spring clips (wedge-profiled output geometry).



**Slotted**

Order-No.	⊖	mm	mm	mm	mm	mm	mm
35446	3,5	100	0,6	204	23		10
35390	4,0	100	0,8	211	30		10
35501	4,5	125	1,0	236	30		10
35391	5,5	125	1,0	243	36		10
35392	6,5	150	1,2	268	36		10

DIN ISO 2380. Manufactured acc. to IEC 60900.

**Phillips**

Order-No.	⊕	mm	mm	mm	mm	mm	mm
35393	PH1	80	191	30			10
35394	PH2	100	218	36			10

DIN ISO 8764-PH. Manufactured acc. to IEC 60900.

**Pozidriv**

Order-No.	⊕	mm	mm	mm	mm	mm	mm
35395	PZ1	80	191	30			10
35396	PZ2	100	218	36			10

DIN ISO 8764-PZ. Manufactured acc. to IEC 60900.

**PlusMinus/Phillips**

Order-No.	⊕	mm	mm	mm	mm	mm	mm
35502	SL/PH1	80	191	30			10
35503	SL/PH2	100	218	36			10

Manufactured acc. to IEC 60900.

**PlusMinus/Pozidriv**

Order-No.	⊕	mm	mm	mm	mm	mm	mm
36329	SL/PZ1	80	191	30			10
36330	SL/PZ2	100	218	36			10

Manufactured acc. to IEC 60900.

**TORX® Tamper Resistant (with hole)**

Order-No.	⊕	mm	mm	mm	mm	mm	mm
41141	T10H	100	204	23			10
41142	T15H	100	211	30			10
41143	T20H	100	211	30			10
41144	T25H	125	243	36			10
41145	T27H	125	243	36			10
41146	T30H	125	243	36			10
41147	T40H	150	268	36			10

Manufactured acc. to IEC 60900.

**TORX®**

Order-No.	⊕	mm	mm	mm	mm	mm	mm
36536	T10	100	204	23			10
36537	T15	100	211	30			10
36538	T20	100	211	30			10
36539	T25	125	243	36			10
36540	T27	125	243	36			10
36541	T30	125	243	36			10
36542	T40	150	268	36			10

DIN ISO 8764-PH. Manufactured acc. to IEC 60900.

**Square**

Order-No.	⊕	mm	mm	mm	mm	mm	mm
35504	#1	2,3	100	211	30		10
35505	#2	2,8	125	243	36		10

Manufactured acc. to IEC 60900.



**⊖ Slotted**

320N

Order-No.	⊖	mm	mm	mm	mm	mm	mm
00819	2,0	60	0,4	164	23		10
00820	2,5	75	0,4	179	23		10
00821	3,0	100	0,5	204	23		10
00822	3,5	100	0,6	204	23		10
00823	4,0	100	0,8	211	30		10
00824	4,5•	125	1,0	236	30		10
00825	4,5•	175	1,0	286	30		5
31863	4,5	200	1,0	311	30		5
00826	5,5	125	1,0	243	36		10
00827	5,5•	175	1,0	293	36		5
00828	6,0•	150	1,2	268	36		10
00829	6,5	150	1,2	268	36		10
00830	8,0	175	1,2	299	41		10
00831	8,0	175	1,6	299	41		10
00832	10,0•	200	1,6	324	41		5

• Additional dimension. Non-DIN size.  
Manufactured acc. to IEC 60900.

**⊕ Phillips**

321N

Order-No.	⊕	mm	mm	mm	mm
00846	PH0	60	164	23	10
00847	PH1	80	191	30	10
00848	PH2	100	218	36	10
00849	PH3	150	268	41	10
00850	PH4	200	318	41	5

Manufactured acc. to IEC 60900.

**⊕ Pozidriv**

324

Order-No.	⊕	mm	mm	mm	mm	mm
00877	PZ0	60	164	23		10
00878	PZ1	80	191	30		10
00879	PZ2	100	218	36		10
00880	PZ3	150	324	41		5

Manufactured acc. to IEC 60900.

**⊕ PlusMinus/Phillips**

327

Order-No.	⊕	mm	mm	mm	mm	mm
30716	SL/PH1	80	191	30		10
30715	SL/PH2	100	218	36		10

Manufactured acc. to IEC 60900.

**⊕ PlusMinus/Pozidriv**

328

Order-No.	⊕	mm	mm	mm	mm	mm
30700	SL/PZ1	80	191	30		10
30701	SL/PZ2	100	218	36		10

Manufactured acc. to IEC 60900.

**⊕ TORX®**

325

Order-No.	⊕	mm	mm	mm	mm	mm
03760	T5	60	164	23		10
03761	T6	60	164	23		10
03762	T7	60	164	23		10
00881	T8	60	164	23		10
00882	T9	60	164	23		10

Manufactured acc. to IEC 60900.

**⊕ Hex**

323N

Order-No.	⊕	mm	mm	mm	mm	mm
30361	2,5	75	179	23		10
30362	3,0	75	179	23		10
30363	4,0	75	186	30		10
30364	5,0	75	186	30		10
30365	6,0	100	218	36		10
30366	8,0	100	218	36		10

Manufactured acc. to IEC 60900.

**⊕ Square**

358N

Order-No.	⊕	mm	mm	mm	mm	mm
32396	#1	2,3	100	211	30	10
32397	#2	2,8	150	268	36	10

Manufactured acc. to IEC 60900.

### Screwdriver SoftFinish® electric



### Hex nut driver

322

Order-No.	Hex	mm	mm	mm	mm	mm
00853	4	125	236	30	10,2	10
00855	5	125	236	30	11,2	10
00856	5,5	125	236	30	11,2	10
00857	6	125	236	30	12,2	10
00858	7	125	243	36	14,5	10
00859	8	125	243	36	15,2	10
00860	9	125	243	36	16,0	10
00861	10	125	243	36	17,2	10
00862	11	125	243	41	19,2	10
00863	12	125	243	41	20,2	10
00864	13	125	243	41	22,2	10
00865	14	125	243	41	23,2	10
00866	15	125	243	41	25,2	10
00867	16	125	243	41	25,2	10
00868	17	125	243	41	27,2	10

Manufactured acc. to IEC 60900.

### Fine screwdriver PicoFinish electric



### Slotted

2270P

Order-No.	Slotted	mm	mm	mm	mm	mm
42374	1,5	50	2,0	152	18	10
42375	2,0	50	2,0	152	18	10
42376	2,5	65	2,5	167	18	10
42377	3	65	3	167	18	10
42471	3,5	65	3,5	167	18	10

### Phillips

2271P

Order-No.	Phillips	mm	mm	mm	mm	mm
42379	PH00	50	2	152	18	10
42378	PH0	65	3	167	18	10
42380	PH1	65	4	167	18	10

### Voltage tester SoftFinish® single-pole, 110-250 volts



### Slotted transparent, with push-on clip

255-11

Order-No.	Slotted	mm	mm	mm	mm	mm	mm
34745	3,0	60	0,5	140	19		10
35378	3,0	60	0,5	140	19	x	5

Tested according to DIN 57680-6, GS, CE compliant.

### Single-pole, explosion-protected, non-contact volt detector, 12-1,000 V AC



### Includes two AAA batteries

25513

Order-No.	Slotted	mm	mm	mm
43797	2	28,5	150	

### Single-pole, non-contact volt detector, 90-1,000 VAC



### Includes two AAA batteries

25514

Order-No.	Slotted	mm	mm	mm
43798	2	28,5	150	5

### Voltage tester 220-250 volts



### Slotted transparent, with push-on clip

255-3

Order-No.	Slotted	mm	mm	mm	mm	mm	mm
05271	3,0	60	140	15			10
32201	3,0	60	140	15	x		5

### Voltage tester 150-250 volts



### Slotted black, with push-on clip

255-7

Order-No.	Slotted	mm	mm	mm	mm	mm	mm
00456	3,0	60	160	17			10
31771	3,0	60	160	17	x		1

Screwdriver set SoftFinish®



assorted 12-pcs.

302

Order-No.	
41002	1
⊖	4,0 x 100 / 3,5 x 100
⊖	6,5 x 150
⊕	PH1 x 80 / PH2 x 100 / PH3 x 150
⊕	PZ1 x 80 / PZ2 x 100
⊕	T15 x 80 / T20 x 100 / T25 x 100 / T30 x 115

Screwdriver set SoftFinish®



Slotted, Phillips 6-pcs.

302

Best.-Nr.	
07152	1
⊖	3,5 x 100 / 4,5 x 125 / 5,5 x 150 / 6,5 x 150
⊕	PH1 x 80 / PH2 x 100

Phillips, Pozidriv 6-pcs.

302

Best.-Nr.	
26113	1
⊖	4,0 x 100 / 5,5 x 125 / 6,5 x 150
⊕	PH1 x 80 / PH2 x 100
⊕	PZ2 x 100

Slotted, Pozidriv 6-pcs.

302

Best.-Nr.	
07153	1
⊖	3,5 x 100 / 4,5 x 125 / 5,5 x 150 / 6,5 x 150
⊕	PZ1 x 80 / PZ2 x 100

TORX® MagicSpring® 6-pcs.

362R

Best.-Nr.	
27746	1
⊕	T10 x 80 / T15 x 80 / T20 x 100 / T25 x 100 / T30 x 115 / T40 x 130

TORX® 7-pcs.

362

Best.-Nr.	
01299	1
⊕	T8 x 60 / T9 x 60 / T10 x 80 / T15 x 80 / T20 x 100 / T25 x 100 / T30 x 115

TORX® 6-pcs.

362

Best.-Nr.	
07155	1
⊕	T10 x 80 / T15 x 80 / T20 x 100 / T25 x 100 / T30 x 115 / T40 x 130

TORX® Tamper Resistant (with hole) 6-pcs.

362TR

Best.-Nr.	
24506	1
⊕	T10H x 80 / T15H x 80 / T20H x 100 / T25H x 100 / T30H x 115 / T40H x 130

INFOBOX:  
Wiha SoftFinish®  
screwdriver



The convenient expert for dry applications.

- The SoftFinish handle provides optimal grip for dry applications in trade and industry.
- The position of the soft and hard zones on the handle also supports the perfect grip for quick and powerful turning.

Screwdriver set SoftFinish®



Hexagon nut driver 5-pcs.

341

Order-No.



01034

1

○ 5,5 x 125 / 7 x 125 / 8 x 125 / 10 x 125 / 13 x 125

Screwdriver set SoftFinish®



Slotted, Phillips with hexagon head 6-pcs.

308

Best.-Nr.



21248

1

⊖ 3,5 x 75 / 4,5 x 90 / 5,5 x 100 / 7,0 x 125

⊕ PH1 x 80 / PH2 x 100

Slotted, Pozidriv with hexagon head, 6-pcs.

308

Best.-Nr.



21249

1

⊖ 3,5 x 75 / 4,5 x 90 / 5,5 x 100 / 7,0 x 125

⊕ PZ1 x 80 / PZ2 x 100

Screwdriver set SoftFinish®



Slotted, Phillips hexagonal blade and solid steel cap, 6-pcs.

530

Best.-Nr.



21250

1

⊖ 3,5 x 75 / 4,5 x 90 / 5,5 x 100 / 6,5 x 125

⊕ PH1 x 80 / PH2 x 100

Slotted, Pozidriv hexagonal blade and solid steel cap, 6-pcs.

530

Best.-Nr.



21251

1

⊖ 3,5 x 75 / 4,5 x 90 / 5,5 x 100 / 6,5 x 125

⊕ PZ1 x 80 / PZ2 x 100

INFOBOX:  
Solid steel cap and hexagon head



- The solid steel cap at the end of the screwdriver handle enables targeted hammering, e.g. to loosen jammed screws.
- The direct connection of the solid steel cap to the blade means that the impact energy is transmitted without any loss.
- Blade includes a hexagon bolster for using a set of spanners for additional torque.





**Slotted, Phillips 7-pcs.**

260P

Best.-Nr.	
42991	1
	1,5 x 40 / 2,0 x 40 / 2,5 x 50 / 3,0 x 50
	PH00 x 40 / PH0 x 50 / PH1 x 60

**Slotted, Phillips, 6 pcs. with holder**

260P

Best.-Nr.	
42990	1
	1,5 x 40 / 2,0 x 40 / 2,5 x 50 / 3,0 x 50
	PH00 x 40 / PH0 x 50

**TORX® MagicSpring®, 6 pcs. with holder**

267PR

Best.-Nr.	
42998	1
	T6 x 40 / T7 x 40 / T8 x 40 / T9 x 50 / T10 x 50 / T15 x 60

**TORX®, 6 pcs. with holder**

267P

Best.-Nr.	
42996	1
	T9 x 50 / T20 x 60 / T8 x 40 / T7 x 40 / T15 x 60 / T10 x 50

**TORX®, 6 pcs. with holder**

267P

Best.-Nr.	
42997	1
	T4 x 40 / T5 x 40 / T6 x 40 / T7 x 40 / T8 x 40 / T9 x 50

**Hexagonal ball end, 6 pcs. with holder**

264P

Best.-Nr.	
42993	1
	0,9 x 0,035
	1,3 (0,05") x 40 / 1,5 x 50 / 2,0 x 50 / 2,5 x 60 / 3,0 x 60
	Ball end from AF 1.3 upwards

**Hex, 6 pcs. with holder**

263P

Best.-Nr.	
42992	1
	0,9 x 0,035 / 1,3 x 0,05 / 1,5 x 50 / 2,0 x 5/64 / 2,5 x 60 / 3 x 60

**Hex nut driver, 6 pcs. with holder**

265P

Best.-Nr.	
42994	1
	2,5 x 60 / 3,0 x 60 / 3,5 x 60 / 4,0 x 60 / 5 x 60 / 5,5 x 60

**INFOBOX:  
MagicSpring®**



**Wiha TORX® MagicSpring®**

- TORX® and TORX PLUS® screws are held securely in place.
- An innovation, which will benefit each user.

**INFOBOX:  
PicoFinish**



**Wiha PicoFinish precision screwdriver**

- The comfortable precision screwdriver for fine and delicate fastenings.
- The smooth-running turn-cap enables fast turning.
- Imprint with the screw symbol and sizes eases recognition.



## Screwdriver SoftFinish®



With round blade for low-lying screws



With round blade



### ⊖ Slotted with round blade for low-lying screws

302

Order-No.	⊖	↔	⊖	●	mm	+	📦
00684	2,0•	65	0,4	2,0	169	23	10
00685	2,5	75	0,4	2,5	179	23	10
00686	3,0•	80	0,5	3,0	184	23	10
00687	3,0	100	0,5	3,0	204	23	10
00689	3,0•	150	0,5	3,0	254	23	10
00690	3,0•	200	0,5	3,0	304	23	10
32383	3,0	300	0,5	3,0	404	23	5
00691	3,5	100	0,6	3,5	204	23	10
26931	3,5•	200	0,6	3,5	304	23	10
00692	4,0	100	0,8	4,0	211	30	10
00694	4,0•	150	0,8	4,0	261	30	10
00695	4,0•	200	0,8	4,0	311	30	10
00696	4,0•	300	0,8	4,0	411	30	10
27753	4,5•	80	0,8	4,5	191	30	10
00697	4,5•	125	0,8	4,5	236	30	10
00698	5,5	125	1,0	5,5	236	30	10
00700	5,5	150	1,0	5,5	261	30	10
00701	5,5•	200	1,0	5,5	311	30	10
00702	5,5•	300	1,0	5,5	411	30	5
32384	6,0•	300	1,0	6,0	418	36	5
39591	2,5	75	0,4	2,5	179	23	10

• Additional dimension. Non-DIN size.

### ⊖ Slotted with round blade

3022

Order-No.	⊖	↔	⊖	●	mm	+	📦
27754	6,0	100	1,0	5,5	218	36	10
27755	6,0	150	1,0	5,5	268	36	10
00704	6,5	100	1,2	6,0	218	36	10
00703	6,5	150	1,2	6,0	268	36	10
00706	6,5•	200	1,2	6,0	318	36	10
00708	8,0	150	1,2	7,0	274	41	10
00707	8,0	175	1,2	7,0	299	41	10
00709	8,0	175	1,6	7,0	299	41	5
32399	8,0	300	1,2	7,0	424	41	5
00711	10,0	200	1,6	8,0	324	41	10
32400	10,0	300	1,6	8,0	424	41	5
00712	12,0	250	2,0	8,0	374	41	10
00713	14,0•	250	2,5	11,0	374	41	10

• Additional dimension. Non-DIN size.  
DIN ISO 2380.

## ⊕ Phillips with round blade

311

Order-No.	⊕	↔	●	mm	+	SB	📦
00754	PH0	60	3,0	164	23		10
27756	PH0	100	3,0	204	23		10
00756	PH1	80	4,5	191	30		10
27757	PH1	100	4,5	211	30		10
00757	PH1•	200	4,5	311	30		10
03738	PH1•	300	4,5	411	30		5
00759	PH2	100	6,0	218	36		10
27758	PH2	150	6,0	268	36		10
00760	PH2•	200	6,0	318	36		10
03739	PH2•	300	6,0	418	36		5
00762	PH3	150	8,0	274	41		10
00763	PH4•	200	10,0	324	41		10

• Additional dimension. Non-DIN size.  
DIN ISO 8764-PH.

## ⊕ Pozidriv with round blade

313

Order-No.	⊕	↔	●	mm	+	SB	📦
00768	PZ0	60	3,0	164	23		10
00770	PZ1	80	4,5	191	30		10
26454	PZ1	300	4,5	411	30		5
00772	PZ2	100	6,0	218	36		10
26455	PZ2	300	6,0	418	36		5
00774	PZ3	150	8,0	274	41		10

## ⊕ TORX® ball end with hexagonal blade

362BE

Order-No.	⊕	↔	●	mm	+	📦	
32250	T9	60	7/64	2,8	164	23	10
32251	T10	60	1/8	3,2	184	23	10
32252	T15	80	9/64	3,6	191	30	10
32253	T20	80	5/32	4,0	211	30	10
32254	T25	100	3/16	4,8	218	36	10
32255	T27	115	7/32	5,6	233	36	10
32256	T30	115	1/4	6,4	233	36	10

## ⊕ TORX® MagicSpring® with round blade

362R

Order-No.	⊕	↔	●	mm	+	📦
27736	T6	60	3,5	164	23	10
27737	T7	60	3,5	164	23	10
27738	T8	60	3,5	164	23	10
27739	T9	60	4,0	171	30	10
27740	T10	80	4,0	191	30	10
27741	T15	80	4,0	191	30	10
27742	T20	100	4,0	218	36	10
27743	T25	100	4,5	218	36	10
27811	T27	115	5,5	233	36	10
27744	T30	115	6,0	233	36	10
27745	T40	130	7,0	254	41	10

**TORX® with round blade**

362

Order-No.							
26259	T3	60	2,5	164	23		10
26260	T4	60	2,5	164	23		10
01285	T5	60	2,5	164	23		10
01286	T6	60	3,5	164	23		10
01287	T7	60	3,5	164	23		10
01288	T8	60	3,5	164	23		10
01289	T9	60	4,0	171	30		10
01290	T10	80	4,0	191	30		10
01291	T15	80	4,0	191	30		10
01292	T20	100	4,0	218	36		10
01293	T25	100	4,5	218	36		10
01294	T27	115	5,5	233	36		10
01295	T30	115	6,0	233	36		10
01296	T40	130	7,0	254	41		10
01297	T45	130	8,0	254	41		5

**TORX® Tamper Resistant (with hole) with round blade**

362TR

Order-No.							
03106	T7H	60	3,5	164	23		10
03107	T8H	60	3,5	164	23		10
03108	T9H	60	4,0	171	30		10
01300	T10H	80	4,0	191	30		10
26457	T10H	300	4,0	411	30		5
01301	T15H	80	4,0	191	30		10
26458	T15H	300	5,0	411	30		5
01302	T20H	100	4,0	211	30		10
28005	T20H	300	5,0	411	30		5
01303	T25H	100	4,5	211	30		10
01304	T27H	115	5,5	233	36		10
01305	T30H	115	6,0	233	36		10
01306	T40H	130	7,0	254	41		10

**TORX PLUS® MagicSpring® with round blade**

362RIP

Order-No.							
28760	6IP	60	3,5	164	23		10
28761	7IP	60	3,5	164	23		10
28762	8IP	60	3,5	164	23		10
28763	9IP	60	4,0	171	30		10
28764	10IP	80	4,0	191	30		10
28765	15IP	80	4,0	191	30		10
28766	20IP	100	4,0	218	36		10
28767	25IP	100	4,5	218	36		10
28769	30IP	115	6,0	233	36		10

**TORX PLUS® with round blade**

362IP

Order-No.							
26091	6IP	60	3,5	164	23		10
26093	7IP	60	3,5	164	23		10
26095	8IP	60	3,5	164	23		10
26097	9IP	60	4,0	171	30		10
26099	10IP	80	4,0	191	30		10
26101	15IP	80	4,0	191	30		10
26103	20IP	100	4,0	218	36		10
26105	25IP	100	4,5	218	36		10
26107	27IP	115	5,5	233	36		10
26109	30IP	115	6,0	233	36		10
26111	40IP	130	7,0	254	41		10

**MagicRing® hexagonal ball end with hexagonal blade**

367R

Order-No.							
26077	3	100	204	23			10
26079	4	100	211	30			10
26081	5	100	211	30			10
26083	6	125	243	36			10
26085	8	150	268	36			10
26087	10	150	271	41			5

**Hexagonal ball end with hexagonal blade**

367

Order-No.							
26303	1,5	75	179	23			10
26304	2	100	204	23			10
26305	2,5	100	204	23			10
26328	3	100	204	23			10
26329	4	100	211	30			10
26330	5	100	211	30			10
26331	6	125	243	36			10
26332	8	150	268	36			10
26333	10	150	271	41			5
26307	12	150	271	41			5

**Hexagon with hexagonal blade**

356

Order-No.							
32264	1,5	60	164	23			10
32265	2	60	164	23			10
26190	2,5	75	179	23			10
26191	3	75	179	23			10
26192	4	75	186	30			10
26193	5	75	186	30			10
26194	6	100	218	36			10
26195	8	100	218	36			10

Screwdriver SoftFinish®



Hexagon angled

357

Order-No.	●	↔	↕	↔	↕	📦
26230	3	35	20	139	23	10
26231	4	40	25	151	30	10
26232	5	45	28	156	30	10
26233	6	50	32	168	36	10
26234	8	60	36	178	36	10

Screwdriver SoftFinish®



Hexagon nut driver with round blade

341

Order-No.	○	↔	↔ mm	↕	↕	📦
01018	4	125	236	30	6,9	10
01020	5	125	236	30	7,9	10
01021	5,5	125	236	30	7,9	10
01022	6	125	236	30	8,9	10
01023	7	125	243	36	10,9	10
01024	8	125	243	36	11,9	10
01025	9	125	243	36	12,9	10
01026	10	125	243	36	14,4	10
01027	11	125	249	41	15,9	10
01028	12	125	249	41	16,9	10
01029	13	125	249	41	18,4	10
01030	14	125	249	41	19,4	10
01031	15	125	249	41	21,9	10
01032	16	125	249	41	21,9	10
01033	17	125	249	41	23,4	10

Hexagon nut driver with short round blade

343

Order-No.	○	↔	↔ mm	↕	↕	📦
01076	5,5	65	176	30	8	10
01077	6	65	176	30	9	10
01078	7	65	183	36	11	10
01079	8	65	183	36	12	10
01081	10	65	183	36	14	10

Screwdriver SoftFinish®



○ Hexagon nut driver, inch design with round blade and hexagon head

347Z

Order-No.	○	↔	○	mm	mm	mm	📦
02836	3/16	125	10	231	30	4,76	10
02837	1/4	125	10	238	36	6,35	10
02838	5/16	125	10	238	36	7,94	10
02839	3/8	125	10	238	36	9,53	10
02840	7/16	125	13	246	41	11,11	10

Screwdriver SoftFinish®



▲ Triangular socket wrench

344

Order-No.	▲	↔	▲	mm	mm	mm	📦
26212	M4	125	6,8	236	30	11	10
26213	M5	125	8,3	236	30	13	10
26216	M6	125	10,05	236	30	16	10
26214	M8	125	12,05	243	36	18	10
26217	M10	125	15,05	243	36	22	10

DIN 22416.

Screwdriver SoftFinish®



○ Hexagon nut driver with flexible shaft

372

Order-No.	○	↔	mm	mm	mm	📦
01435	5	150	261	30	8	10
01436	5,5	150	261	30	8	10
01437	6	150	261	30	9	10
01438	7	150	268	36	11	10
01439	8	150	268	36	12	10
01440	10	175	293	41	14	10
01443	13	175	293	41	19	10

Screwdriver SoftFinish®



○ Hexagon nut driver with round blade and hexagon head

347

Order-No.	○	↔	○	mm	mm	mm	📦
01092	7	125	10	238	36	11,0	10
01093	8	125	10	238	36	12,0	10
01094	9	125	10	238	36	13,0	10
01095	10	125	10	238	36	14,5	10
01096	11	125	13	246	41	16,0	10
01097	12	125	13	246	41	17,0	10
01098	13	125	13	246	41	19,0	10

Screwdriver SoftFinish®



⊖ Slotted with one-piece hexagonal blade and solid steel cap

530

Order-No.	⊖	↔	⊖	⬠	⬡	mm	📦
03223	3,5	75	0,6	4,0	-	186	10
03224	4,5•	90	0,8	4,0	-	201	10
03225	5,5	100	1,0	5,0	8	213	10
03226	6,5	125	1,2	6,0	10	238	10
03228	8,0	150	1,2	8,0	13	271	5
03230	10,0	175	1,6	8,0	13	296	5
03231	12,0	200	2,0	10,0	16	321	5
03232	14,0•	250	2,5	10,0	16	371	5
39845	4,5•	90	0,8	4,0	-	201	10
39846	5,5	100	1,0	5,0	8	213	10
39847	6,5	125	1,2	6,0	10	238	10
39848	8,0	150	1,2	8,0	13	271	5
39849	10,0	175	1,6	8,0	13	296	5
39851	14,0•	250	2,5	10,0	16	371	5

• Additional dimension. Non-DIN size.

⊕ Phillips with one-piece hexagonal blade and solid steel cap

531

Order-No.	⊕	↔	⬠	⬡	mm	↔	📦
03237	PH1	80	5,0	8	186	30	10
03238	PH2	100	6,0	10	213	36	10
03239	PH3	150	8,0	13	268	41	10
39838	PH1	80	5,0	8	186	30	10
39839	PH2	100	6,0	10	213	36	10
39840	PH3	150	8,0	13	268	41	10

⊕ Pozidriv with one-piece hexagonal blade and solid steel cap

532

Order-No.	⊕	↔	⬠	⬡	mm	↔	📦
03245	PZ1	80	5,0	8	186	30	10
03246	PZ2	100	6,0	10	213	36	10
03247	PZ3	150	8,0	13	268	41	10
39841	PZ1	80	5,0	8	186	30	10
39843	PZ3	150	8,0	13	268	41	10

Screwdriver SoftFinish®



⊖ Slotted with round blade and lasered mm scale

3021

Order-No.	⊖	↔	⊖	●	mm	↔	📦
36085	4,0	100	0,8	4,0	211	30	10
35397	5,5	125	1,0	5,5	236	30	10

DIN ISO 2380.

⊕ Phillips with round blade and lasered mm scale

3111

Order-No.	⊕	↔	●	mm	↔	Scale	📦
36072	PH1	80	4,5	191	30	20-70	10
35398	PH2	100	6,0	218	36	20-90	10

DIN ISO 8764-PH.

Screwdriver SoftFinish®



⊖ Slotted with fixing function

398

Order-No.	⊖	↔	⊖	mm	↔	📦
32867	2,5	75	0,4	186	30	5
32868	3,0	100	0,5	211	30	5
32869	4,0	125	0,8	243	36	5
32870	5,0	150	1,0	268	36	5
32871	6,0	175	1,2	293	36	5

⊕ Phillips with fixing function

397

Order-No.	⊕	↔	mm	↔	📦
32406	PH0	100	211	30	5
32404	PH1	125	236	36	5
32405	PH2	175	286	36	5

Screwdriver SoftFinish®



⊖ Slotted with short round blade

302SY

Order-No.	⊖	↔	⊖	●	mm	↔	📦
26964	4,0	25	0,8	4,0	81	34	10
26965	5,5	25	1,0	5,5	81	34	10
26966	6,5	25	1,2	6,5	81	34	10
26967	8,0	25	1,2	8,0	81	34	10

⊕ Phillips with short round blade, Stubby

311SY

Order-No.	⊕	↔	●	mm	↔	📦
26968	PH1	25	4,5	81	34	10
26969	PH2	25	6,0	81	34	10
26970	PH3	25	8,0	81	34	10

⊕ Pozidriv with short round blade, Stubby

313SY

Order-No.	⊕	↔	●	mm	↔	📦
26971	PZ1	25	4,5	81	34	10
26972	PZ2	25	6,0	81	34	10
26973	PZ3	25	8,0	81	34	10

Screwdriver SoftFinish®



⊖ Slotted with hexagonal blade and hexagon head

308

Order-No.	⊖	↔	⊖	●	○	mm	📦
00731	3,5	75	0,6	4,0	-	186	10
00732	4,5•	90	0,8	4,0	-	201	10
00733	5,5	100	1,0	5,0	8	213	10
00734	6,5	125	1,2	6,0	10	238	10
00735	7,0•	125	1,1	6,0	10	238	10
00736	8,0	150	1,2	8,0	13	268	10
00737	9,0•	150	1,4	8,0	13	268	10
00738	10,0	175	1,6	8,0	13	293	10
00739	12,0	200	2,0	10,0	16	318	10
00740	14,0•	250	2,5	10,0	16	368	10

• Additional dimension. Non-DIN size.

⊕ Phillips with hexagonal blade and hexagon head

312

Order-No.	⊕	↔	●	○	mm	↔	📦
00764	PH1	80	5,0	8	186	30	10
00765	PH2	100	6,0	10	213	36	10
00766	PH3	150	8,0	13	268	41	10
00767	PH4	200	10,0	16	318	41	10

⊕ Pozidriv with hexagonal blade and hexagon head

314

Order-No.	⊕	↔	●	○	mm	↔	📦
00776	PZ1	80	5,0	8	186	30	10
00777	PZ2	100	6,0	10	213	36	10
00778	PZ3	150	8,0	13	268	41	10
00779	PZ4	200	10,0	16	318	41	10

Square reamer



■ with square tip and plastic handle

300

Order-No.	■	↔	mm	↔	📦
00679	6,0	100	185	34	10

Awl plastic handle



● with round tip and plastic handle

301

Order-No.	●	↔	mm	↔	📦
00683	6,0	100	185	34	10



⊖ Slotted

260P

Order-No.	⊖	↔	●	mm	↔	📦
42381	0,8	40	2	134	9	10
42382	1,0	40	2	134	9	10
42383	1,2	40	2	134	9	10
42384	1,5	40	2	134	9	10
42385	1,5	60	2	154	9	10
42386	1,8	40	2	134	9	10
42387	1,8	60	2	154	9	10
42388	2,0	40	2	140	18	10
42389	2,0	60	2	160	18	10
42390	2,0	100	2	200	18	10
42391	2,5	50	2,5	150	18	10
42392	2,5	75	2,5	175	18	10
42393	2,5	100	2,5	200	18	10
42394	3,0	50	3	150	18	10
42395	3,0	100	3	200	18	10
42397	3,5	60	3,5	160	18	10
42398	4,0	60	4	160	18	10
42399	4,0	100	4	200	18	10

⊕ Phillips

261P

Order-No.	⊕	↔	●	mm	↔	📦
42403	PH000	40	2	134	9	10
42402	PH00	40	2	134	9	10
42413	PH00	60	2	154	9	10
42401	PH0	50	3	150	18	10
42414	PH0	75	3	175	18	10
42415	PH1	60	4	160	18	10
42416	PH1	80	4	180	18	10

⊕ Pozidriv

262P

Order-No.	⊕	↔	●	mm	↔	📦
42418	PZ0	50	3	150	18	10
42419	PZ1	60	4	160	18	10

⊕ TORX® MagicSpring®

267PR

Order-No.	⊕	↔	●	mm	↔	📦
42501	T6	40	2,5	140	18	10
42502	T7	40	2,5	140	18	10
42503	T8	40	2,5	140	18	10
42504	T9	50	3	150	18	10
42505	T10	50	3	150	18	10
42506	T15	60	3,5	150	18	10

⊕ TORX®

267P

Order-No.	⊕	↔	●	mm	↔	📦
42474	T1	40	2,5	134	9	10
42475	T2	40	2,5	134	9	10
42476	T3	40	2,5	134	9	10
42477	T4	40	2,5	134	9	10
42478	T5	40	2,5	134	9	10
42479	T6	40	2,5	140	18	10
42480	T7	40	2,5	140	18	10
42481	T8	40	2,5	140	18	10
42482	T9	50	3	150	18	10
42483	T10	50	3	150	18	10
42484	T15	60	3,5	160	18	10
42485	T20	60	4	160	18	10

⊕ TORX PLUS®

267PIP

Order-No.	⊕	↔	●	mm	↔	📦
42486	4IP	40	2,5	134	9	10
42487	5IP	40	2,5	134	9	10
42488	6IP	40	2,5	140	18	10
42489	7IP	40	2,5	140	18	10
42490	8IP	40	2,5	140	18	10
42491	9IP	50	3	150	18	10
42492	10IP	50	3	150	18	10
42493	15IP	60	3,5	160	18	10
42494	20IP	60	4	160	18	10

⊕ Pentalobe

266P

Order-No.	⊕	↔	●	mm	↔	📦
42464	PL1	40	2,5	134	9	10
42465	PL2	40	2,5	134	9	10
42466	PL3	40	2,5	134	9	10
42467	PL4	40	2,5	134	9	10
42468	PL5	40	2,5	134	9	10
42469	PL6	40	2,5	140	18	10

⊕ Y-type

266PY

Order-No.	⊕	↔	●	mm	↔	📦
42470	Y000	40	2	134	9	10

⊕ PH with pivot

2611P

Order-No.	⊕	↔	●	mm	↔	📦
43882	PH00	40	2,5	134	9	10



### ● Ball end hex

264P

Order-No.	●	↔	mm	↔	↔	☒
42431	1,3 (0,05")	40	134	9		10
42432	1,5	50	150	18		10
42433	2,0	50	150	18		10
42434	2,5	60	160	18		10
42435	3,0	60	160	18		10

### ● Hex

263P

Order-No.	●	↔	mm	↔	↔	☒
42420	0,70,028	40	134	9		1
42421	0,90,035	40	134	9		1
42422	1,30,05	40	134	9		1
42423	1,5	50	144	9		1
42424	2,05/64	50	150	18		1
42425	2,5	60	160	18		1
42426	3	60	160	18		1
42427	1/161/16	50	144	9		1
42428	1/81/8	60	160	18		1
42429	3/323/32	60	160	18		1
42430	7/647/64	60	160	18		1

### ● Hexagonal ball end, inch design

264PZ

Order-No.	●	↔	mm	↔	↔	☒
42436	1/16"	50	150	18		10
42440	5/64"	50	150	18		10
42438	3/32"	50	150	18		10
42441	7/64"	60	160	18		10
42437	1/8"	60	160	18		10
42442	9/64"	60	160	18		10
42439	5/32"	60	160	18		10

### PicoFinish® fine screwdriver



### ○ Hex nut driver

265P

Order-No.	○	↔	mm	↔	↔	☒
42443	1,5	60	160	18		10
42444	1,8	60	160	18		10
42445	2	60	160	18		10
42446	2,5	60	160	18		10
42447	3,0	60	160	18		10
42448	3,2	60	160	18		10
42449	3,5	60	160	18		10
42450	4,0	60	160	18		10
42451	4,5	60	160	18		10
42452	5	60	160	18		10
42453	5,5	60	160	18		10
42454	6	60	160	18		10
42455	7	60	160	18		10

### ○ Hexagon nut driver, inch design

265PZ

Order-No.	○	↔	mm	↔	↔	☒
42459	3/32"	60	160	18		10
42462	7/64"	60	160	18		10
42457	1/8"	60	160	18		10
42463	9/64"	60	160	18		10
42460	5/32"	60	160	18		10
42458	3/16"	60	160	18		10
42461	7/32"	60	160	18		10
42456	1/4"	60	160	18		10

## INFOBOX: Pentalobe



### The security profile for Apple devices.

- Ideal for repairing Apple smartphones, tablets and notebooks.
- Note: The guarantee and warranty conditions of the device manufacturer must be observed.

### Lifter PicoFinish



268P

Order-No.	↔	●	mm	↔	☒	☒	☒
42507	50	3,5	150	18	1	3,5	10

**Small screwdriver**



⊖ Slotted transparent-red, with push-on clip

500

Order-No.	⊖	→	●	mm	→	📦
01537	3,0	40	3,0	100	11	50
01538	3,0	60	3,0	120	11	50
01539	3,0	80	3,0	140	11	50



430

**SoftFinish® universal scraper**



Order-No.



23159

5

**Small screwdriver**



⊖ Slotted transparent-yellow

509

Order-No.	⊖	→	●	mm	→	📦
01548	2,0	40	2,0	85	8	50

**SoftFinish® universal scraper set**



**12-pcs. in blister pack**

SB 430 4010

Order-No.



26920

1

**Magnetiser**



400 10

Order-No.	📦	📦
01508		5
02568	x	5

**Replacement blade set, 13 mm wide**



**10-pcs. for universal scraper in blister pack**

SB 430 40 K10

Order-No.



27606

5

Screwdriver MicroFinish®



Slotted, Phillips with one-piece hexagonal blade and solid steel cap, 5-pcs.

5533

Best.-Nr.	
29138	1
	5,5 x 100 / 6,5 x 125 / 8,0 x 150
	PH1 x 80 / PH2 x 100

Slotted, Pozidriv with one-piece hexagonal blade and solid steel cap, 5-pcs.

5533

Best.-Nr.	
29139	1
	5,5 x 100 / 6,5 x 125 / 8,0 x 150
	PZ1 x 80 / PZ2 x 100

Screwdriver MicroFinish®



TORX® with round blade

5527

Order-No.							
29162	T10	80	4,0	192	30		10
29163	T15	80	4,0	192	30		10
29164	T20	100	4,0	212	30		10
29165	T25	100	4,5	212	30		10

Screwdriver MicroFinish®



Slotted with one-piece hexagonal blade and solid steel cap

5533

Order-No.							
29133	4,5•	90	0,8	4,0	-	201	10
29134	5,5	100	1,0	5,0	8	213	10
29135	6,5	125	1,2	6,0	10	238	10
29136	8,0	150	1,2	8,0	13	271	10
29137	10,0•	175	1,6	8,0	13	296	5

• Additional dimension. Non-DIN size.  
DIN 5265, ISO 2380.

Phillips with one-piece hexagonal blade and solid steel cap

5534

Order-No.							
29149	PH1	80	5,0	8	187	30	10
29150	PH2	100	6,0	10	214	36	10
29151	PH3	150	8,0	13	271	41	10

DIN ISO 8764-PH.

Pozidriv with one-piece hexagonal blade and solid steel cap

5535

Order-No.							
29158	PZ1	80	5,0	8	187	30	10
29159	PZ2	100	6,0	10	214	36	10

DIN ISO 8764-PZ.

INFOBOX:  
Wiha MicroFinish  
screwdriver



The specialist for wet and oily applications.

- Due to the micro-fine surface structure of the screwdriver handle, the user can gain an optimal hold, even with oily or wet hands.
- The position of the soft and hard zones on the handle also supports the perfect grip for quick and powerful turning.

## Screw extractor set



### Hex, 8-pcs. with spiral drill bit in box

405

Order-No.	
03988	10
2,3 / 2,8 / 3,4 / 4,5 / 5,7 / 6,8 / 9,0 / 11,0 /	
	2,0 / 2,5 / 3,0 / 4 / 5 / 6 / 8 / 10

## Screw extractor



Order-No.				
03847	2,0	85	6,0	10
03848	2,5	85	6,0	10
03849	3,0	85	6,0	10
03850	4	85	6,0	10
03851	5	85	6,0	10
03852	6	95	8,0	10
03853	8	95	10,0	10
03854	10	110	12,0	10

## Twist drill



Order-No.			
06725	2,3	53	10
06726	2,8	51	10
06727	3,4	70	10
06728	4,5	80	10
06729	5,7	93	10
06730	6,8	109	10
06731	9,0	117	10
06732	11,0	142	10

## Screwdriver set SoftFinish® ESD



### Slotted, Phillips 5-pcs.

302ESD

Best.-Nr.	
27252	1
	3,0 x 100 / 4,0 x 100
	PH0 x 60 / PH1 x 80 / PH2 x 100
IEC 61340-5-1.	

### TORX® 5-pcs.

362ESD

Best.-Nr.	
27253	1
	T6 x 60 / T8 x 60 / T9 x 60 / T10 x 80 / T15 x 80
IEC 61340-5-1.	

## INFOBOX: Electrostatic conductive ESD tools

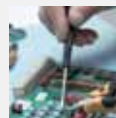

**Sensitive, electronic components can be damaged even at a very low voltage.**

- Dissipative tools by Wiha discharge the electrostatic energy in a controlled, safe manner.
- ESD tools meet the ESD Standard IEC 61340-5-1.
- ESD tool handles have a surface resistance of  $10^6 - 10^9$  Ohm.

## Screwdriver SoftFinish® ESD



### ⊖ Slotted

302ESD

Order-No.	⊖	↔	⊖	●	mm	↔	📦
08179	2,5	75	0,4	2,5	179	23	10
27150	3,0	100	0,5	3,0	204	23	10
27151	4,0	100	0,8	4,0	211	30	10
08182	5,5	125	1,0	5,5	236	30	10
08183	6,5	150	1,2	6,0	268	36	10

IEC 61340-5-1.

### ⊕ Phillips

311ESD

Order-No.	⊕	↔	●	mm	↔	📦
08184	PH0	60	3,0	164	23	10
08185	PH1	80	4,5	191	30	10
08186	PH2	100	6,0	218	36	10

IEC 61340-5-1.

### ⊕ Pozidriv

313ESD

Order-No.	⊕	↔	●	mm	↔	📦
26928	PZ0	60	3,0	164	23	10
26929	PZ1	80	4,5	191	30	10

IEC 61340-5-1.

### ⊕ TORX®

362ESD

Order-No.	⊕	↔	●	mm	↔	📦
31432	T3	60	2,5	164	23	10
27148	T4	60	2,5	164	23	10
27641	T5	60	3,5	164	23	10
27149	T6	60	3,5	164	23	10
31901	T7	60	3,5	164	23	10
22436	T8	60	3,5	164	23	10
27145	T9	60	4,0	171	30	10
27144	T10	80	4,0	191	30	10
27146	T15	80	4,0	191	30	10
27147	T20	100	4,0	218	36	10

IEC 61340-5-1.

## Fine screwdriver set PicoFinish® ESD



### Slotted, Phillips, 6 pcs. with holder

270P

Best.-Nr.	📦
43707	1
⊖	1,5 x 0,23 / 2,0 x 0,4 / 2,5 x 0,4 / 3 x 0,5
⊕	PH 0 x 50 / PH 00 x 40

### TORX®, 6 pcs. with holder

277P

Best.-Nr.	📦
43708	1
⊕	5 x 40 / 6 x 40 / 7 x 40 / 8 x 40 / 10 x 50 / 15 x 60



**Slotted**

270P

Order-No.	⌀	⌀	↔	●	mm	↔	📦
43669	1,5	0,23	40	2	134	9	10
43670	2,0	0,4	40	2	140	18	10
43671	2,5	0,4	50	2,5	150	18	10
43672	3	0,5	50	3	150	18	10
43673	3,5	0,6	60	3,5	160	18	10
43674	4	0,8	60	4	160	18	10

**Pentalobe**

276P

Order-No.	●	↔	●	mm	↔	📦
43692	PL 1	40	2,5	134	9	10

**Y-type**

276PY

Order-No.	⚙	↔	●	mm	↔	📦
43693	Y000	40	2	134	9	10

**Phillips**

271P

Order-No.	⊕	↔	●	mm	↔	📦
43675	PH 000	40	2	134	9	10
43676	PH 00	40	2	134	9	10
43677	PH 0	50	3	150	18	10
43678	PH 1	60	4	160	18	10

**TORX®**

277P

Order-No.	⚙	↔	●	mm	↔	📦
43694	1	40	2,5	134	9	10
43695	2	40	2,5	134	9	10
43696	3	40	2,5	134	9	10
43697	4	40	2,5	134	9	10
43698	5	40	2,5	134	9	10
43699	6	40	2,5	140	18	10
43700	7	40	2,5	140	18	10
43701	8	40	2,5	140	18	10
43702	9	50	3	150	18	10
43703	10	50	3	150	18	10
43704	15	60	3,5	150	18	10
43705	20	60	4	150	18	10

**Hex**

273P

Order-No.	●	↔	●	mm	📦
43679	0,7	40	2,5	134	10
43680	0,9	40	2,5	134	10
43681	1,3	40	2,5	134	10
43682	1,5	50	2,5	144	10
43683	2	50	3	150	10
43684	2,5	60	3	160	10
43685	3	60	4	160	10

**Hex nut driver**

275P

Order-No.	○	↔	mm	↔	📦
43686	2,5	60	160	18	10
43687	3	60	160	18	10
43688	3,5	60	160	18	10
43689	4	60	160	18	10
43690	5	60	160	18	10
43691	5,5	60	160	18	10

Lifter PicoFinish® ESD



278P

Order-No.	↔	●	mm	↔	📦
43706	50	3,5	150	18	10

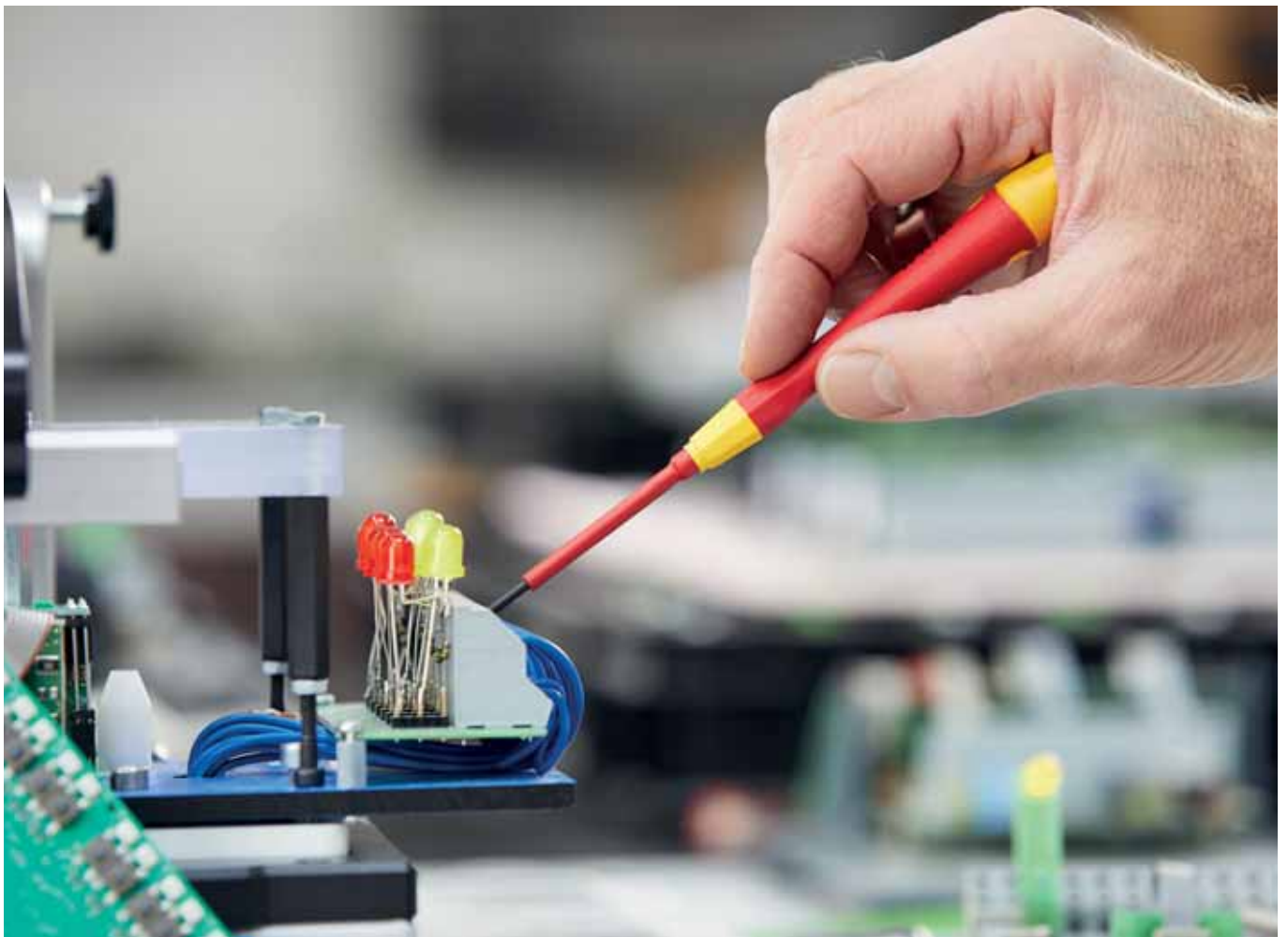



## **Torque tools**

### **Controlled power for greater security.**

The correct torque prevents damage to materials, eliminates the need for retouching and protects against warranty claims. This makes fully certified Wiha torque tools essential for mechanics, electricians and electronics technicians as they combine precision with security: with a release accuracy of  $\pm 6\%$  for the pre-set scale value, Wiha torque screwdrivers satisfy standard precision requirements.

Torque tools with fixed settings increase process reliability while tools with variable settings are particularly ideal for mobile use. A special interchangeable blade system offers interchangeable blades with different drives. Guaranteed individual item testing using the manufacturer's inspection process and individual item marking with an identification number attest to the high quality and manufacturing standard of the tools.



## Application

## Torque tools

For applications  
in electrics



**Torque screwdriver set  
TorqueVario®-S electric,  
Mixed, variably adjustable  
torque limit, 18 pcs. in  
folding bag**  
Page 194



**Torque screwdriver  
TorqueVario®-S electric,  
Variable torque limit  
settings**  
Page 195



**Torque adapter  
easyTorque electric**  
Page 196



**Torque screwdriver with  
T-handle TorqueVario®-S  
T electric, Variable torque  
limit settings**  
Page 200



For applications  
in mechanics



**Torque screwdriver  
iTorque®  
with digital scale**  
Page 201



**Torque screwdriver set  
TorqueVario®-S, mixed, 13  
pcs., variably adjustable  
torque limit, 0.8–5.0 Nm  
in box**  
Page 202



**Torque screwdriver  
TorqueVario®-S, Variable  
torque limit settings**  
Page 202



**Torque screwdriver  
TorqueFix®, permanently  
pre-set torque limit**  
Page 203



**Torque screwdriver with  
T-handle set  
TorqueVario®-S T,  
mixed, 11 pcs., variably  
adjustable torque limit,  
5–14 Nm in box**  
Page 206



**Torque screwdriver with  
T-handle TorqueVario®-S  
T, Variable torque limit  
settings**  
Page 206



For applications  
in electronics



**Torque screwdriver set  
TorqueVario®-S ESD,  
mixed, 13 pcs., variably  
adjustable torque limit,  
0,4-1,0 Nm in box**  
Page 209



**Torque screwdriver  
TorqueVario®-S ESD,  
Variable torque limit  
settings**  
Page 209



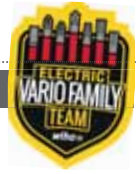

**Mixed, variably adjustable torque limit, 18 pcs. in folding bag**

2872 T18

Order-No.



36791

1

- 1 x Torque screwdriver TorqueVario®-S electric Variable torque limit settings, VDE and GS tested / 0,8-5,0 Nm  
1 x Adjusting tool for torque screwdriver with long handle
- 1 x Adapter TorqueVario-S electric for slimBits
- ⊖ 1 x 2,5 / 1 x 3,5 / 1 x 5,5 / 1 x 6,5
- ⊕ 1 x PH1 / 1 x PH2
- ⊗ 1 x PZ1 / 1 x PZ2
- ⊗ 1 x SL/PZ1 / 1 x SL/PZ2
- ⊗ 1 x T9 / 1 x T10 / 1 x T15 / 1 x T20 / 1 x T25

Manufactured acc. to IEC 60900. DIN EN ISO 6789.

**INFOBOX:  
VDE-certified tools**



Wiha VDE-tested tools are subject to stringent safety test procedures.

All tools with the special marking have been tested at 10,000 V AC and are therefore approved for use at 1,000 V AC and 1,500 V DC.

The following equipment is required for all work on or around live components and should be appropriate for the specific task

- insulating personal protective equipment
- insulating safety mechanisms
- insulated tools

Before starting work, you must disconnect all active, live components of electrical machines and equipment and ensure that they remain disconnected while you carry out the work.

This is achieved by complying with the five safety rules:

- disconnect
- secure against reconnection
- ensure power is switched off
- earth and short-circuit
- cover or block off adjacent live components

Certified by the VDE Testing and Certification Institute and individually tested according to the international standard IEC 60900.

Torque screwdriver set TorqueVario®-S electric

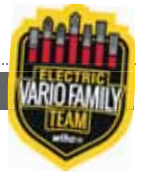

Mixed, variably adjustable torque limit, 13 pcs. in folding bag

2872 T13

Order-No.		
40674		1
<input type="radio"/>	1 x Torque screwdriver TorqueVario®-S electric Variable torque limit settings, VDE and GS tested / 0,8-5,0 Nm	
	1 x Adjusting tool for torque screwdriver with long handle	
<input type="radio"/>	1 x Screwdriver with bit holder SoftFinish® electric slimVario for slimBits, VDE and GS tested	
<input type="radio"/>	1 x Adapter TorqueVario-S electric for slimBits	
<input type="radio"/>	1 x 2,5 / 1 x 3,5 / 1 x 5,5	
<input type="radio"/>	1 x PH1 / 1 x PH2	
<input type="radio"/>	1 x PZ1 / 1 x PZ2	
<input type="radio"/>	1 x SL/PZ1 / 1 x SL/PZ2	

Manufactured acc. to IEC 60900. DIN EN ISO 6789.



Torque screwdriver set TorqueVario®-S electric



PlusMinus/Pozidriv variably settable torque limit 5-pcs.

2872 S3

Order-No.		
38074		1
<input type="radio"/>	1 x Torque screwdriver TorqueVario®-S electric Variable torque limit settings, VDE and GS tested / 0,8-5,0 Nm	
	1 x Adjusting tool for torque screwdriver with long handle	
<input type="radio"/>	1 x Adapter TorqueVario-S electric for slimBits	
<input type="radio"/>	1 x SL/PZ1 / 1 x SL/PZ2	

Manufactured acc. to IEC 60900. DIN EN ISO 6789.

Torque screwdriver TorqueVario®-S electric



Variable torque limit settings

2872

Order-No.	Nm	±%				
26625	0,5-2,0	6 %	3,8	131	30	1
26626	0,8-5,0	6 %	3,8	138	36	1
26627	2,0-7,0	6 %	3,8	142	41	1

Manufactured acc. to IEC 60900. DIN EN ISO 6789.

Torque set easyTorque adapter electric

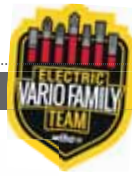

with slimVario® holder and SL/PZ slimBits, 4-pcs. in blister pack

29701 080 S4

Best.-Nr.	
41476	1
	1 x 0,8 Nm
	1 x SL/PZ1 / 1 x SL/PZ2
	1 x SoftFinish® electric screwdriver handle
Manufactured acc. to IEC 60900.	

with slimVario® holder and SL/PZ slimBits, 4-pcs. in blister pack

29701 200 S4

Best.-Nr.	
41477	1
	1 x 2,0 Nm
	1 x SL/PZ1 / 1 x SL/PZ2
	1 x SoftFinish® electric screwdriver handle
Manufactured acc. to IEC 60900.	

with slimVario® holder and SL/PZ slimBits, 4-pcs. in blister pack

29701 280 S4

Best.-Nr.	
41478	1
	1 x 2,8 Nm
	1 x SL/PZ1 / 1 x SL/PZ2
	1 x SoftFinish® electric screwdriver handle
Manufactured acc. to IEC 60900.	

Torque set easyTorque adapter electric



for slimBits and slimVario® holder, 5-pcs. in blister pack

29701 S5

Order-No.	
41479	1
	1 x 0,8 Nm / 1 x 2,0 Nm / 1 x 2,5 Nm / 1 x 2,8 Nm / 1 x 4,0 Nm
Manufactured acc. to IEC 60900.	

Torque adapter easyTorque electric



for slimBits and slimVario® holder in blister

2970

Order-No.	Nm	±%			
41341	0,8	10 %	59	5,5	1
41342	2,0	10 %	59	5,5	1
41343	2,5	10 %	59	5,5	1
41344	2,8	10 %	59	5,5	1
41345	4,0	10 %	59	5,5	1
Manufactured acc. to IEC 60900.					

slimBit electric bit set



assorted with slimBit holder, 7-pcs.

2879 B7

Order-No.		
36079		1
○	1 x Adapter TorqueVario-S electric for slimBits	
⊖	1 x 4,0 / 1 x 5,5	
⊕	1 x PH1 / 1 x PH2	
⊗	1 x PZ1 / 1 x PZ2	

Manufactured acc. to IEC 60900.

Adapter TorqueVario-S electric



○ for slimBits

28799

Order-No.	○	⊖	mm	
35870	6	3,8	170	13

Manufactured acc. to IEC 60900.

Adapter TorqueVario-S electric



○ for 1/4" nut driver

28799

Order-No.	○	⊖	mm	
43128	1/4"	3,8	178	12

Manufactured acc. to IEC 60900.

INFOBOX:  
slimTECHNOLOGY



Wiha SoftFinish® electric slimFix

- Unlimited access.
- Blades up to 33 % narrower due to integrated insulation.
- Tool for spring clips (wedge-profiled output geometry).

slimBit electric bit set



Slotted, 6-pcs. in SlimBit box

2831

Best.-Nr.	
43152	6
⊖	1 x 2,0 / 1 x 2,5 / 1 x 3,5 / 1 x 4,0 / 1 x 5,5 / 1 x 6,5

Manufactured acc. to IEC 60900.

TORX®, 6-pcs. in SlimBit box

2831

Best.-Nr.	
43153	6
⊗	1 x T8 / 1 x T9 / 1 x T10 / 1 x T15 / 1 x T20 / 1 x T25

Manufactured acc. to IEC 60900.

TORX®, 6-pcs. in SlimBit box



2831

Best.-Nr.	
43154	6
⊗	1 x T6 / 1 x T7 / 1 x T8 / 1 x T9 / 1 x T10 / 1 x T15

Manufactured acc. to IEC 60900.



**TORX PLUS®, 6-pcs. in SlimBit box**

2831

Best.-Nr.	
43155	6
	1 x 6IP / 1 x 7IP / 1 x 8IP / 1 x 9IP / 1 x 10IP / 1 x 15IP
Manufactured acc. to IEC 60900.	



**Hex, 6-pcs. in SlimBit box**

2831

Best.-Nr.	
43156	6
	1 x 2 / 1 x 2,5 / 1 x 3 / 1 x 4 / 1 x 5 / 1 x 6
Manufactured acc. to IEC 60900.	



**Slotted, Pozidriv 6-pcs. in SlimBit box**

2831

Best.-Nr.	
43157	6
	1 x 2,5 / 1 x 3,5 / 1 x 5,5 / 1 x 6,5
	1 x PZ1 / 1 x PZ2
Manufactured acc. to IEC 60900.	



**Slotted, PlusMinus/Pozidriv 6-pcs. in SlimBit box**

2831

Best.-Nr.	
43158	6
	1 x 2,5 / 1 x 3,5 / 1 x 5,5 / 1 x 6,5
	1 x SL/PZ1 / 1 x SL/PZ2
Manufactured acc. to IEC 60900.	





**Slotted, Phillips 6-pcs. in SlimBit box**

2831

Best.-Nr.	
43159	6
	1 x 2,5 / 1 x 3,5 / 1 x 5,5 / 1 x 6,5
	1 x PH1 / 1 x PH2
Manufactured acc. to IEC 60900.	

**Slotted, Phillips, Pozidriv 6-pcs. in SlimBit box**

2831



Best.-Nr.	
43160	6
	1 x 2,0 / 1 x 2,5
	1 x PH0 / 1 x PH1
	1 x PZ0 / 1 x PZ1
Manufactured acc. to IEC 60900.	

**slimBit electric bit set**









**TORX®, TORX PLUS®, 12-pcs. in SlimBit box**

2831

Best.-Nr.	
43161	6
	1 x 6IP / 1 x 7IP / 1 x 8IP / 1 x 9IP / 1 x 10IP / 1 x 15IP
	1 x T6 / 1 x T7 / 1 x T8 / 1 x T9 / 1 x T10 / 1 x T15
1 x slimBit-Box empty, 2-pcs. with belt clip	
Manufactured acc. to IEC 60900.	

**Slotted, Phillips, Pozidriv, PlusMinus/Pozidriv, TORX® 12-pcs. in SlimBit box**

2831

Best.-Nr.	
43162	6
	1 x 3,5 / 1 x 5,5
	1 x PH1 / 1 x PH2
	1 x PZ1 / 1 x PZ2
	1 x SL/PZ1 / 1 x SL/PZ2
	1 x T10 / 1 x T15 / 1 x T20 / 1 x T25
1 x slimBit-Box empty, 2-pcs. with belt clip	
Manufactured acc. to IEC 60900.	

slimBit electric bit

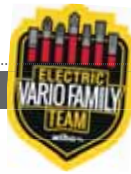

**TORX®**

283115

Order-No.		mm		max. Nm	
43140	T5	75	6,0	0,4	5
43141	T6	75	6,0	0,4	5
43142	T7	75	6,0	0,4	5
35506	T8	75	6,0	1,3	5
41160	T9	75	6,0	1,3	5
35507	T10	75	6,0	3,8	5
35508	T15	75	6,0	5,0	5
35509	T20	75	6,0	5,5	5
36071	T25	75	6,0	5,5	5

• no slim version  
Manufactured acc. to IEC 60900.

**Slotted**

283110

Order-No.		mm			max. Nm	
43114	1,5	75	0,4	6,0	0,4	5
43115	2,0	75	0,4	6,0	0,4	5
34578	2,5	75	0,4	6,0	0,4	5
34579	3,0	75	0,5	6,0	0,6	5
41159	3,5	75	0,6	6,0	1,4	5
34580	4,0	75	0,8	6,0	2,5	5
34581	5,5	75	1,0	6,0	3,8	5
34582	6,5	75	1,2	6,0	5,5	5

• no slim version  
Manufactured acc. to IEC 60900.

**Phillips**

283111

Order-No.		mm		max. Nm	
43116	PH0	75	6,0	0,4	5
34583	PH1	75	6,0	3,8	5
34584	PH2	75	6,0	5,5	5

Manufactured acc. to IEC 60900.

**Pozidriv**

283112

Order-No.		mm		max. Nm	
43117	PZ0	75	6,0	0,5	5
34585	PZ1	75	6,0	3,8	5
34586	PZ2	75	6,0	5,5	5

Manufactured acc. to IEC 60900.

**PlusMinus/Phillips**

283113

Order-No.		mm		max. Nm	
34587	SL/PH1	75	6,0	3,8	5
34588	SL/PH2	75	6,0	5,5	5

Manufactured acc. to IEC 60900.

**PlusMinus/Pozidriv**

283114

Order-No.		mm		max. Nm	
34589	SL/PZ1	75	6,0	3,8	5
34590	SL/PZ2	75	6,0	5,5	5

Manufactured acc. to IEC 60900.

**Hex**

283118

Order-No.		mm		max. Nm	
37222	1,5	75	6,0	0,9	5
37223	2	75	6,0	1,8	5
37224	2,5	75	6,0	3,8	5
37147	3	75	6,0	5,5	5
37225	4	75	6,0	5,5	5
37226	5	75	6,0	5,5	5
37227	6	75	6,0	5,5	5

• no slim version  
Manufactured acc. to IEC 60900.

**Square**

283117

Order-No.		mm		max. Nm	
35510	#1	2,3	75	6,0	5,5
35511	#2	2,8	75	6,0	5,5

Manufactured acc. to IEC 60900.



## Torque screwdriver with T-handle TorqueVario®-S T electric



### Variable torque limit settings

2933

Order-No.	Nm	74%	○	↕	↕	📦
43177	5-14	6	6	56	120	1

Manufactured acc. to IEC 60900. DIN EN ISO 6789.

## INFOBOX: Torque T-handle TorqueVario®-S T electric



### Torque T-handle TorqueVario®-S T electric

- For controlled fastening in a large range of applications.
- Torque value is continuously adjustable thanks to the adjusting tool.
- More fastening power thanks to T-handle design.
- Each tool individually tested at 10,000 V AC and approved for 1,000 V AC.
- Certified individual item testing directly after on-site production.
- Broad selection of interchangeable blades

## Interchangeable electric blade



### TORX® for torque screwdriver with T-handle electric

283795

Order-No.	⚙️	mm	↕	max. Nm	📦
38931	T15	136	35	5,5	10
38932	T20	136	35	10	10
38933	T25	136	35	15	10
38934	T27	136	35	15	10
38935	T30	136	35	20	10
38936	T40	136	35	20	10

Manufactured acc. to IEC 60900.

## Interchangeable electric blade



### Hex for torque screwdriver with T-handle electric

283793

Order-No.	⚙️	mm	↕	max. Nm	📦
38918	3,0	136	35	5,5	10
38919	4,0	136	35	15	10
38920	5,0	136	35	20	10
38921	6,0	136	35	20	10

Manufactured acc. to IEC 60900.

## Interchangeable electric blade



### Hex nut driver for torque screwdriver with T-handle electric

283794

Order-No.	⚙️	mm	max. Nm	📦
38925	7,0	136	5	10
38926	8,0	136	10	10
38927	9,0	136	14	10
38928	10,0	136	17	10
38929	13,0	136	20	10
38930	17,0	136	20	10

Manufactured acc. to IEC 60900.



Adjusting tool



for torque screwdriver with T-handle

2899



Order-No.		mm	
28691	90	146	1

Torque screwdriver iTorque®



with digital scale

28352

Order-No.	Nm	in.oz	±%	⊙			
36886	0,4-1,5	60-210	6%	4	134	34	1
36887	0,8-3,0	7-26	6%	4	134	34	1
36888	1,0-5,0	9-44	6%	4	134	40	1

DIN EN ISO 6789.



INFOBOX:  
iTorque



The intelligent torque tool.

- Required torque can be adjusted and set on the handle without the need for a separate tool.
- Large numerical display simplifies reading.
- ClickControl records every use and optimises the monitoring of measuring instruments.
- Calibration alarm after 5,000 applications for absolute process safety.
- Certified individual item testing directly after on-site production.
- Broad selection of interchangeable blades and adapter blades.
- Units can be switched (Nm » in.lb/ cNm » in.oz)
- Can be recalibrated

## Torque screwdriver set TorqueVario®-S



mixed, 13 pcs., variably adjustable torque limit, 0.8–5.0 Nm in box

2852 S10

Best.-Nr.  26893 1

- Torque screwdriver TorqueVario®-S Variable torque limit settings / 0,8-5,0 Nm
- Bit holder clamping with ball for torque screwdriver with long handle
- Adjusting tool for torque screwdriver with long handle
- PH1 x 25 / PH2 x 25
- PZ1 x 25 / PZ2 x 25
- T10 x 25 / T15 x 25 / T20 x 25 / T25 x 25
- 3,0 x 25 / 4,0 x 25

DIN EN ISO 6789.

**TORX®, TORX PLUS®, 13 pcs., variably adjustable torque limit, 0.8–5.0 Nm in box**

2852 S10-01

Best.-Nr.  34614 1

- Torque screwdriver TorqueVario®-S Variable torque limit settings / 0,8-5,0 Nm
- Bit holder clamping with ball for torque screwdriver with long handle
- Adjusting tool for torque screwdriver with long handle
- T7 x 25 / T8 x 25 / T9 x 25 / T10 x 25 / T15 x 25
- 7IP x 25 / 8IP x 25 / 9IP x 25 / 10IP x 25 / 15IP x 25



DIN EN ISO 6789.

## Torque screwdriver TorqueVario®-S



### Variable torque limit settings

2852

Order-No.	Nm	±6%	<input type="radio"/>			
36849	0,04-0,46•	10%	4	127	23	1
26888	0,1-0,6	10%	4	127	23	1
36850	0,1-0,6	6%	4	127	23	1
26461	0,4-1,0	6%	4	127	23	1
26462	0,5-2,0	6%	4	131	30	1
26463	0,8-5,0	6%	4	138	36	1
26464	2,0-7,0	6%	4	142	41	1

• Precision in range of 0.1-0.46 Nm.  
DIN EN ISO 6789.

### INFOBOX: TorqueVario®-S



#### Variably settable torque tools.

- For controlled fastening in a large range of applications.
- Torque value is continuously adjustable thanks to the torque setter adjusting tool.
- Distinctly audible and perceptible click signal when set torque is reached.
- Each Wiha screwdriver handle provides a perfectly correlated ratio of guidance, speed and torque for any fastening task.
- Certified individual item testing directly after on-site production.
- Broad selection of interchangeable blades and adapter blades.

## Torque screwdriver TorqueFix®



### ○ permanently pre-set torque limit

2850

Order-No.	Nm	±%	○	↔	↕	📦
26925	0,4	6%	4	112	23	1
26127	0,5	6%	4	112	23	1
26047	0,6	6%	4	112	23	1
26327	0,8	6%	4	112	23	1
26048	0,9	6%	4	112	23	1
26133	1,1	6%	4	119	30	1
26049	1,2	6%	4	119	30	1
26901	1,5	6%	4	119	30	1
26051	2,0	6%	4	119	30	1
26128	2,5	6%	4	119	30	1
26052	3,0	6%	4	126	36	1
26129	3,8	6%	4	126	36	1
26053	5,0	6%	4	132	41	1
26130	5,5	6%	4	132	41	1
34533	6,0	6%	4	132	41	1
26131	7,2	6%	4	132	41	1

DIN EN ISO 6789.

## Torque screwdriver set TorqueFix®



### Cable key for circular plug connector permanently pre-set torque limit 2-pcs.

2850

Order-No.	Nm	⌒	↔ mm	↔	↕	↕	📦
36846	0,4	9	230	78	112	23	1
36847	0,6	13	230	78	112	23	1

DIN EN ISO 6789.

## Torque screwdriver easyTorque



### ○ permanently pre-set torque limit

2920

Order-No.	Nm	±%	○	↔	↕	📦
36229	0,5	10%	4	130	34	1
36230	0,6	10%	4	130	34	1
36240	0,9	10%	4	130	34	1
36231	1,1	10%	4	130	34	1
36233	1,2	10%	4	130	34	1
36234	1,4	10%	4	130	34	1
36235	2,0	10%	4	130	34	1
36236	2,5	10%	4	130	34	1
36237	3,0	10%	4	130	34	1
36238	3,8	10%	4	130	34	1
36320	4,0	10%	4	130	34	1
36321	4,5	10%	4	130	34	1
36239	5,0	10%	4	130	34	1

## INFOBOX: TorqueFix®



### Permanently pre-set torque tools.

- For controlled fastening, e.g. in series production or repetitive usage.
- Distinctly audible and perceptible click signal when set torque is reached.
- Each Wiha screwdriver handle provides a perfectly correlated ratio of guidance, speed and torque for any fastening task.
- Broad selection of interchangeable blades and adapter blades.

## Interchangeable blade



### ☉ Slotted for torque screwdriver with long handle

28590

Order-No.	☉	☉	●	mm	mm	max. Nm	
26227	0,25	1,5	4	175	42	0,15	10
26228	0,4	2,0	4	175	42	0,4	10
26151	0,4	2,5	4	175	42	0,4	10
26277	0,5	3,0	4	175	42	0,6	10
26278	0,6	3,5	4	175	42	1,1	10
26279	0,8	4,0	4	175	42	2,5	10

Blade tip DIN ISO 2380-1.

### ⊕ Phillips for torque screwdriver with long handle

28591

Order-No.	⊕	●	mm	mm	max. Nm	
26199	PH000	4	175	42	0,4	10
26196	PH00	4	175	42	0,4	10
26197	PH0	4	175	42	0,9	10
26058	PH1	4	175	42	3,8	10
27079	PH2	4	175	42	5,5	10

Blade tip DIN ISO 8764-1.

### ⊗ Pozidriv for torque screwdriver with long handle

28592

Order-No.	⊗	●	mm	mm	max. Nm	
26198	PZ0	4	175	42	0,9	10
26148	PZ1	4	175	42	3,8	10
26889	PZ2	4	175	42	5,5	10

Blade tip DIN ISO 8764-1.

### ⊗ TORX® MagicSpring® for torque screwdriver with long handle

28595R

Order-No.	⊗	●	mm	mm	max. Nm	
27818	T6	4	175	42	0,6	10
27812	T7	4	175	42	0,9	10
27813	T8	4	175	42	1,3	10
27814	T9	4	175	42	2,5	10
27815	T10	4	175	42	3,8	10
27816	T15	4	175	42	5,5	10
27817	T20	4	175	42	8,0	10
29467	T25	4	175	42	8,0	10

### ⊗ TORX® for torque screwdriver with long handle

28595

Order-No.	⊗	●	mm	mm	max. Nm	SB	
30852	T4	4	175	42	0,25		10
26158	T5	4	175	42	0,4		10
26064	T6	4	175	42	0,6		10
26065	T7	4	175	42	0,9		10
26066	T8	4	175	42	1,3		10
26059	T9	4	175	42	2,5		10
26067	T10	4	175	42	3,8		10
26068	T15	4	175	42	5,5		10
26069	T20	4	175	42	8,0		10
26070	T25	4	175	42	8,0		10

### ⊗ TORX PLUS® MagicSpring® for torque screwdriver with long handle

28596R

Order-No.	⊗	●	mm	mm	max. Nm	
29553	6IP	4	175	42	0,8	10
29554	7IP	4	175	42	1,3	10
29555	8IP	4	175	42	2,0	10
29556	9IP	4	175	42	3,0	10
29557	10IP	4	175	42	4,5	10
29558	15IP	4	175	42	6,6	10
29559	20IP	4	175	42	8,0	10
29560	25IP	4	175	42	8,0	10

### ⊗ TORX PLUS® for torque screwdriver with long handle

28596

Order-No.	⊗	●	mm	mm	max. Nm	SB	
26159	5IP	4	175	42	0,5		10
26071	6IP	4	175	42	0,8		10
26152	7IP	4	175	42	1,3		10
26072	8IP	4	175	42	2,0		10
26154	9IP	4	175	42	3,0		10
26155	10IP	4	175	42	4,5		10
26073	15IP	4	175	42	6,6		10
26156	20IP	4	175	42	8,0		10
26157	25IP	4	175	42	8,0		10

### ⊗ Hexagonal ball end for torque screwdriver with long handle

28597

Order-No.	●	●	mm	mm	max. Nm	
26221	1,5	4	175	42	0,4	10
26222	2,0	4	175	42	0,9	10
26223	2,5	4	175	42	2,0	10
26224	3,0	4	175	42	3,8	10
26225	4,0	4	175	42	8,0	10

● Hexagon for torque screwdriver with long handle

28593

Order-No.	⌀	mm	mm	mm	max. Nm	
26544	1,3	4	175	42	0,4	10
26200	1,5	4	175	42	0,9	10
26060	2,0	4	175	42	1,8	10
26061	2,5	4	175	42	3,8	10
26062	3,0	4	175	42	5,5	10
26063	4,0	4	175	42	8,0	10

Cable key for circular plug connector



⌒ Hexagon head for torque screwdriver with long handle

28594

Order-No.	⌒	mm	mm	mm	max. Nm	
36414	8	4	78	218	1	10
36415	9	4	78	218	1	10
36417	13	4	78	218	1,5	10
36418	14	4	78	218	1,5	10
36421	18	4	78	218	1,5	5

INFOBOX:  
MagicSpring®



Wiha TORX® MagicSpring®

- TORX® and TORX PLUS® screws are held securely in place.
- An innovation, which will benefit each user.

INFOBOX:  
Ball end hex



Wiha hexagonal ball end

- The ball end can be rotated by up to 25° in both clockwise and anti-clockwise direction.

Adapter blade



⊖ internal square for torque screwdriver with long handle

285992

Order-No.	⊖	mm	mm	
26229	1/4	4	155	10

Bit holder clamping with ball



○ for torque screwdriver with long handle

285994

Order-No.	○	mm	mm	mm	
27526	1/4	4	162	11	10

Adjusting tool



for torque screwdriver with long handle

2859

Order-No.	mm	mm	
26864	146	90	1

**Torque screwdriver with T-handle set TorqueVario®-S T**



**mixed, 11 pcs., variably adjustable torque limit, 5-14 Nm in box**

2893 S01

Order-No.	Icon
29234	1
<input type="radio"/>	Torque screwdriver with T-handle TorqueVario®-S T Variable torque limit settings / 5-14 Nm Adjusting tool for torque screwdriver with T-handle
<input checked="" type="checkbox"/>	Adapter blade for torque screwdriver with T-handle 1/4" / Adapter blade for torque screwdriver with T-handle 3/8" /
<input type="radio"/>	Bit holder for torque screwdriver with T-handle
<input checked="" type="checkbox"/>	T25 x 25 / T30 x 25 / T40 x 25
<input checked="" type="checkbox"/>	4,0 x 25 / 5,0 x 25 / 6,0 x 25

DIN EN ISO 6789.

**Torque screwdriver with T-handle TorqueVario®-S T**



**Variable torque limit settings**

2893

Order-No.	Nm	±%	⊙	⌊	⌋	📦
29233	5-14	6%	6	56	120	1

DIN EN ISO 6789.

**Torque screwdriver with T-handle TorqueFix® T**



**permanently pre-set torque limit**

2891

Order-No.	Nm	±%	⊙	⌊	⌋	📦
29228	6	6%	6	56	120	1
29229	8	6%	6	56	120	1
29230	10	6%	6	56	120	1
29231	12	6%	6	56	120	1
29236	12,5	6%	6	56	120	1
29232	14	6%	6	56	120	1

DIN EN ISO 6789.

## Interchangeable blade



### TORX® for torque screwdriver with T-handle

28995

Order-No.					max. Nm	max. in.lbs.	
28734	T15	6	130	53	5,5	49	10
28735	T20	6	130	53	10	88	10
28736	T25	6	130	53	15	132	10
28737	T27	6	130	53	15	132	10
28738	T30	6	130	53	15	132	10
28739	T40	6	130	53	15	132	10

### TORX PLUS® for torque screwdriver with T-handle

28996

Order-No.					max. Nm	max. in.lbs.	
28740	15IP	6	130	53	6,6	59	10
28741	20IP	6	130	53	13	115	10
28742	25IP	6	130	53	15	132	10
28743	27IP	6	130	53	15	132	10
28744	30IP	6	130	53	15	132	10
28745	40IP	6	130	53	15	132	10

### Hex for torque screwdriver with T-handle

28993

Order-No.					max. Nm	max. in.lbs.	
28746	3	6	130	53	5,5	49	10
28747	4	6	130	53	15	132	10
28748	5	6	130	53	15	132	10
28749	6	6	130	53	15	132	10

## Adapter blade



### for torque screwdriver with T-handle

28999

Order-No.					
28756	1/4	6	120	53	10
28757	3/8	6	120	53	10

## Bit holder



### for torque screwdriver with T-handle

28999

Order-No.					
28758	1/4	6	125	11	10

## Adjusting tool



### for torque screwdriver with T-handle

28999

Order-No.			
28691	90	146	1



### Torque screwdriver with key handle TorqueFix® Key



#### ○ permanently pre-set torque limit

28360

Order-No.	Nm	±6%	○	↕	↕	☒
38616	0,5	6%	4	68	50	1
38617	0,6	6%	4	68	50	1
38618	0,9	6%	4	68	50	1
38556	1,1	6%	4	68	50	1
38800	1,2	6%	4	68	50	1
38619	1,4	6%	4	68	50	1
38557	2,0	6%	4	68	50	1
38620	2,5	6%	4	68	50	1
38621	3,0	6%	4	68	50	1
38558	3,8	6%	4	68	50	1
38622	4,0	6%	4	68	50	1

DIN EN ISO 6789.

### Interchangeable blade



#### ● Hexagon for torque screwdriver with key handle

283693

Order-No.	●	●	mm	↕	max. Nm	☒
38801	1,5	4	75	20	0,9	10
38802	2,0	4	75	20	1,8	10
38803	2,5	4	75	20	3,8	10
38804	3,0	4	75	20	5,5	10
38805	4,0	4	75	20	8,0	10

### Interchangeable blade



#### ● TORX® for torque screwdriver with key handle

283695

Order-No.	●	●	mm	↕	max. Nm	☒
38806	T6	4	75	20	0,6	10
38807	T7	4	75	20	0,9	10
38808	T8	4	75	20	1,3	10
38809	T9	4	75	20	2,5	10
38810	T10	4	75	20	3,8	10
38811	T15	4	75	20	5,5	10
38812	T20	4	75	20	8,0	10
38813	T25	4	75	20	8,0	10

### Interchangeable blade



#### ● TORX PLUS® for torque screwdriver with key handle

283696

Order-No.	●	●	mm	↕	max. Nm	☒
38814	6IP	4	75	20	0,8	10
38815	7IP	4	75	20	1,3	10
38816	8IP	4	75	20	2,0	10
38817	9IP	4	75	20	3,0	10
38818	10IP	4	75	20	4,5	10
38819	15IP	4	75	20	6,6	10
38820	20IP	4	75	20	8,0	10
38821	25IP	4	75	20	8,0	10



Torque screwdriver set TorqueVario®-S ESD



mixed, 13 pcs., variably adjustable torque limit, 0,4-1,0 Nm in box

2882 S10

Order-No.		
43898	1	
○	Torque screwdriver TorqueVario®-S ESD Variable torque limit settings / 0,4-1,0 Nm	
○	Bit holder clamping with ball for torque screwdriver with long handle	
	Adjusting tool for torque screwdriver with long handle	
⊖	4,0 x 25 / 4,5 x 25	
⊕	PH0 x 25 / PH1 x 25	
⊕	PZ0 x 25 / PZ1 x 25	
⊕	T4 x 25 / T5 x 25 / T6 x 25 / T8 x 25	

IEC 61340-5-1. DIN EN ISO 6789.

Torque screwdriver TorqueVario®-S ESD



○ Variable torque limit settings

2882

Order-No.	Nm	±%	○	⊖	⊕	⊕
36851	0,04-0,46	10%	4	127	23	1
26865	0,1-0,6	10%	4	127	23	1
36852	0,1-0,6	6%	4	127	23	1
26629	0,4-1,0	6%	4	127	23	1
26866	0,5-2,0	6%	4	131	30	1
30495	0,8-5,0	6%	4	138	36	1

• Precision in range of 0.1-0.46 Nm.  
IEC 61340-5-1. DIN EN ISO 6789.





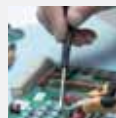







INFOBOX:  
Electrostatic  
conductive ESD  
tools



Sensitive, electronic components can be damaged even at a very low voltage.

- Dissipative tools by Wiha discharge the electrostatic energy in a controlled, safe manner.
- ESD tools meet the ESD Standard IEC 61340-5-1.
- ESD tool handles have a surface resistance of  $10^6 - 10^9$  Ohm.

# Overview of torque tools

Tools	Precision	Setting	Special feature	Nm range	Torque range			
					0,01 Nm	0,1 Nm	1 Nm	10 Nm
<b>iTorque</b> 	± 6 %	variable	Écran digital Click control Calibration alarm Numeric scale	0,4 – 1,5 0,8 – 3,0 1,0 – 5,0				
<b>TorqueVario®-S</b> 	± 10 % ± 6 %/± 10 % ± 6 %	variable	Numeric scale	0,04 – 0,46 0,1 – 0,6 0,4 – 1,0 0,5 – 2,0 0,8 – 5,0 2,0 – 7,0				
<b>TorqueVario®-S ESD</b> 	± 10 % ± 6 %/± 10 % ± 6 %	variable	ESD-compliant, numeric scale	0,04 – 0,46 0,1 – 0,6 0,4 – 1,0 0,5 – 2,0 0,8 – 5,0				
<b>TorqueFix®</b> 	± 6 %	fixed	Permanently preset in factory	16 Versions 0,4 – 7,2				
<b>easyTorque</b> 	± 10 %	fixed	Permanently preset in factory	13 Versions 0,5 – 5,0				
<b>TorqueFix® Key</b> 	± 6 %	fixed	Permanently preset in factory	0,5 – 4,0				
<b>easyTorque adapter</b> 	± 10 %	fixed	VDE certification Permanently preset in factory	5 Versions 0,8 – 4,0				
<b>TorqueVario®-S VDE</b> 	± 6 %	variable	VDE certification, numeric scale	0,8 – 5,0 2,0 – 7,0				
<b>TorqueVario®-S T electric</b> 		variable	VDE certification, numeric scale	5 – 14				
<b>TorqueVario®-S T</b> 	± 6 %	variable	Numeric scale	5,0 – 14				
<b>TorqueFix®-T</b> 	± 6 %	fixed	Permanently preset in factory	6 Versions 6,0 – 14				

Interchangeable blades

Series 2859



Series 28369

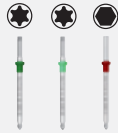

slimBits  
Series 2831

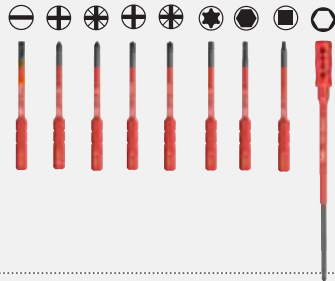

Series 28379



Series 2899





## Multitools



### Many talents in the minimum space.

Fewer tools mean less load, better handling and efficient work. The more a tool can do, the better: Wiha multitools are compact, versatile tools which save space and reduce overall weight, making them the perfect portable companion.

In the Wiha LiftUp magazine bit holder, the most commonly used bits are neatly stored in the handle, ensuring they are always ready for use and easy to handle. The Wiha reversible blade system offers a variety of interchangeable blades, the lengths of which can be adjusted as required. The small, compact Wiha PocketStars contain the most commonly used L-keys - indispensable helpers for all equipment. The Wiha Stubby magazine combines six drive formats in one, allowing completely unrestricted access to all confined spaces thanks to its extremely short screwdriver handle.

## Application

## Multitools

All-in-one tools	Screwdriver with bit magazine LiftUp electric Page 214	Screwdriver with bit magazine, LiftUp 26one® Page 214	Screwdriver with bit magazine Stubby Page 214	Double bit set Page 215
				
	<b>Multitool PocketStar®, assorted 9-pcs.</b> Page 217	<b>Multitool PocketStar®, TORX® 8-pcs.</b> Page 217	<b>Multitool PocketStar®, Hexagonal ball end MagicRing® 7-pcs.</b> Page 219	<b>Switch cabinet key pen shape</b> Page 220
	<b>Nut driver insert gripper,</b> Page 220			
Interchangeable blade sets	<b>Screwdriver with interchangeable blade set SYSTEM 6, Mixed 11-pcs. in box</b> Page 221	<b>Screwdriver with interchangeable blade set SYSTEM 6, Mixed 11-pcs. in roll-up bag</b> Page 221	<b>Screwdriver with interchangeable blade set SYSTEM 6 ESD, Mixed 6-pcs. in roll-up bag</b> Page 223	
	<b>Screwdriver with interchangeable blade set SYSTEM 4, Mixed 11-pcs. in roll-up bag</b> Page 225	<b>Screwdriver with interchangeable blade set SYSTEM 4 ESD, Mixed 11-pcs. in roll-up bag</b> Page 227		
				
				



Screwdriver with bit magazine LiftUp electric



Slotted, Phillips with 6 slimBits

2831

Order-No.	SB	Blister
38610		5
38612	x	1
⊖ 1 x 2,5 / 1 x 3,0 / 1 x 4,0 / 1 x 5,5 ⊕ 1 x PH1 / 1 x PH2 Manufactured acc. to IEC 60900.		

Phillips, PlusMinus/Pozidriv, slotted with 6 slimBits

2831

Order-No.	SB	Blister
38611		5
38613	x	1
⊖ 1 x 3,0 / 1 x 4,0 / 1 x 5,5 ⊕ 1 x PH1 / 1 x PH2 ⊗ 1 x SL/PZ2 Manufactured acc. to IEC 60900.		

Pozidriv, PlusMinus/Pozidriv, slotted with 6 slimBits

2831

Order-No.	SB	Blister
41234		5
41235	x	1
⊖ 1 x 2,5 / 1 x 3,5 / 1 x 5,5 ⊗ 1 x PZ1 / 1 x PZ2 ⊗ 1 x SL/PZ2 Manufactured acc. to IEC 60900.		

TORX® with 6 slimBits

2831

Order-No.	SB	Blister
41157		5
41158	x	1
⊗ 1 x T8 / 1 x T9 / 1 x T10 / 1 x T15 / 1 x T20 / 1 x T25 Manufactured acc. to IEC 60900.		

Screwdriver with bit magazine, LiftUp 26one®



Mixed with 13 double bits in blister pack

SB 3803 04 020

Order-No.	SB	Blister
43895	x	1
⊖ ⊖ 4,0 - 6,0 / 5,5 - 6,5 ⊕ ⊕ PH0 - PH3 / PH1 - PH2 ⊗ ⊗ T6 - T8 / T10 - T15 / T20 - T25 / T27 - T30 ⊗ ⊗ PZ1 - PZ2 ⊗ ⊗ #1 - #2 ⊗ ⊗ 3 - 4 / 5 - 6		

Screwdriver with bit magazine Stubby



Mixed with 7 double bits 1/4"

3802

Order-No.	SB	Blister
43613	x	5
⊖ ⊖ 4,0 x 6,0 ⊕ ⊕ PH1 x PH2 ⊗ ⊗ PZ1 x PZ2 ⊗ ⊗ 3 x 4 / 5 x 6 ⊗ ⊗ T10 x T15 / T20 x T25		

INFOBOX:  
slimTECHNOLOGY



Wiha SoftFinish® electric slimFix

- Unlimited access.
- Blades up to 33 % narrower due to integrated insulation.
- Tool for spring clips (wedge-profiled output geometry).



**Slotted, 10-pcs. in box**

7410Z

Ordern-No.	
43858	1
	4,0 x 6,0

**Slotted, 10-pcs. in box**

7410Z

Ordern-No.	
43859	1
	5,5 x 6,5

**Phillips, 10-pcs. in box**

7411Z

Ordern-No.	
43860	1
	PH0 x PH3

**Phillips, 10-pcs. in box**

7411Z

Ordern-No.	
43861	1
	PH1 x PH2

**Pozidriv, 10-pcs. in box**

7412Z

Ordern-No.	
43862	1
	PZ0 x PZ3

**Pozidriv, 10-pcs. in box**

7412Z

Ordern-No.	
43863	1
	PZ1 x PZ2

**Internal hexagon, 10-pcs. in box**

7413Z

Ordern-No.	
43864	1
	3 x 4

**Internal hexagon, 10-pcs. in box**

7413Z

Ordern-No.	
43865	1
	5 x 6

**TORX®, 10 pieces in box**

7415Z

Ordern-No.	
43866	1
	T6 x T8

**TORX®, 10 pieces in box**

7415Z

Ordern-No.	
43867	1
	T10 x T15

**TORX®, 10 pieces in box**

7415Z

Ordern-No.	
43868	1
	T20 x T25

**TORX®, 10 pieces in box**

7415Z

Ordern-No.	
43869	1
	T27 x T30

**Internal square, 10-pcs. in box**

7419Z

Ordern-No.	
43870	1
	#1 x #2



**INFOBOX:**  
**LiftUp 26one®**

**Most of the world's common drives in one tool!**

- The LiftUp 26one® has 13 double bits; 12 in the magazine and 1 double bit in the bit holder.
- The bit magazine opens out at the press of a button, enabling the removal of the bits.
- Unlimited access to low-lying screws thanks to the automatically locking SuperSlim bit holder.
- Powerful screw fastening or loosening thanks to the large screwdriver handle.



Screwdriver with LiftUp 25 magnetic bit magazine



Mixed with 12 bits, 1/4"

380302

Order-No.	SB	SB
38600		5
38605	x	5
⊖	1 x 4,5 / 1 x 6,5	
⊕	1 x PH1 / 1 x PH2 / 1 x PH3	
⊕	1 x PZ1 / 1 x PZ2 / 1 x PZ3	
⊕	1 x T15 / 1 x T20 / 1 x T25 / 1 x T30	

Mixed with 12 bits, 1/4"

380302

Order-No.	SB	SB
38601		5
38606	x	5
⊖	1 x 5,5	
⊕	1 x PH2	
⊕	1 x PZ1 / 1 x PZ2 / 1 x PZ3	
⊕	1 x T15 / 1 x T20 / 1 x T25 / 1 x T30	
⊕	1 x 3,0 / 1 x 4,0 / 1 x 5,0	

Screwdriver with bit magazine magnetic



assorted with 8 bits, 1/4"

3809

Order-No.	SB	SB
32901		5
33007	x	5
⊖	1 x 6,5	
⊕	1 x PH1 / 1 x PH2 / 1 x PH3	
⊕	1 x PZ2	
⊕	1 x T15 / 1 x T20 / 1 x T25	

TORX® with 8 bits, 1/4"

3809

Order-No.	SB	SB
32902		5
33008	x	5
⊕	1 x T6 / 1 x T8 / 1 x T10 / 1 x T15 / 1 x T20 / 1 x T25 / 1 x T30 / 1 x T40	

Slotted, Phillips with 8 bits, 1/4"

3809

Order-No.	SB	SB
32903		5
33009	x	5
⊖	1 x 5,5 / 1 x 6,5	
⊕	1 x PH1 / 3 x PH2 / 2 x PH3	

Screwdriver with bit magazine magnetic



Slotted, Phillips with 6 bits, Stubby, 1/4"

3801

Order-No.	SB	SB
33736		10
33738	x	5
⊖	1 x 4,5 / 1 x 6,5 / 1 x 8,0	
⊕	1 x PH1 / 1 x PH2 / 1 x PH3	

Phillips, Pozidriv with 6 bits, Stubby, 1/4"

3801

Order-No.	SB	SB
33740		10
33741	x	5
⊕	1 x PH1 / 1 x PH2 / 1 x PH3	
⊕	1 x PZ1 / 1 x PZ2 / 1 x PZ3	

TORX® with 6 bits, Stubby, 1/4"

3801

Order-No.	SB	SB
33743		10
33744	x	5
⊕	1 x T10 / 1 x T15 / 1 x T20 / 1 x T25 / 1 x T30 / 1 x T40	

Slotted, Pozidriv with 6 bits, Stubby, 1/4"

3801

Order-No.	SB	SB
33764		10
33746	x	5
⊖	1 x 4,5 / 1 x 6,5 / 1 x 8,0	
⊕	1 x PZ1 / 1 x PZ2 / 1 x PZ3	



### Multitool PocketStar



#### assorted 9-pcs.

351P

Order-No.	SB	Blister
25293		5
25295	x	5
⊖	4,5	
⊕	PH2	
⊗	T10 / T15 / T20	
●	3 / 4 / 5 / 6	

### Multitool PocketStar



#### TORX® 8-pcs.

363P

Order-No.	SB	Blister
23047		5
23049	x	5
⊗	T9 / T10 / T15 / T20 / T25 / T27 / T30 / T40	

### Multitool Mini PocketStar



#### Slotted, Phillips internal hexagon, 8-pcs. in blister pack

351P

Order-No.	SB	Blister
27936	x	5
●	0,7 / 0,9 / 1,3 / 1,5 / 2,0	
⊖	1,5 / 2,0	
⊕	PH00	

#### INFOBOX: PocketStar



#### The Multitool that fits in your pocket

- Simple and easy selection of the desired key size at the touch of a button.
- Can be used as a screwdriver long handle and T-handle.
- 270° limit for safe work prevents trapped fingers.
- Covered ends on both pivot axes prevent clothing from being caught.



Multitool PocketStar



**TORX® 7-pcs.**

363P

Order-No.	SB	Icon
23051		5
23053	x	5
T7 / T8 / T9 / T10 / T15 / T20 / T25		

Multitool PocketStar



**TORX® Tamper Resistant (with hole) 7-pcs.**

363TRP

Order-No.	SB	Icon
25128		5
25164	x	5
T7H / T8H / T9H / T10H / T15H / T20H / T25H		

Multitool PocketStar



**TORX® Tamper Resistant (with hole) 8-pcs.**

363TRP

Order-No.	SB	Icon
25130		5
25166	x	5
T9H / T10H / T15H / T20H / T25H / T27H / T30H / T40H		

INFOBOX:  
**TORX® tamper-resistant safety profile**



- This safety profile is used to hinder unwanted access to equipment such as intercoms, thermostats and night-storage heaters.
- You can fasten the Torx® tamper resistant profile with both Torx® H screws and normal Torx® screws.

Multitool PocketStar



Hexagonal ball end MagicRing® 7-pcs.

369RP

Order-No.	SB	Grid
23031		5
23033	x	5
●	2 / 2,5 / 3 / 4 / 5 / 6 / 8	

Multitool PocketStar



Hexagon 7-pcs.

351P

Order-No.	SB	Grid
23040		5
23041	x	5
●	2 / 2,5 / 3 / 4 / 5 / 6 / 8	

Multitool PocketStar



Hexagon 7-pcs.

351P

Order-No.	SB	Grid
23035		5
23037	x	5
●	1,5 / 2 / 2,5 / 3 / 4 / 5 / 6	



INFOBOX:  
Ball end hex



Wiha hexagonal ball end

- The ball end can be rotated by up to 25° in both clockwise and anti-clockwise direction.

INFOBOX:  
MagicRing®



Wiha MagicRing®

- Spring steel ring reliably holds hex screws in place
- An innovation, which will benefit each user.

Switch cabinet key pen shape



⊖ 1/4" in blister pack

24681

Order-No.	⊖	⬆	⦿	⊖	⊕	⦿	📦
39076	5-8	9	3-5	7,0	PH2	T20	1

Nut driver insert set gripper



Hexagon with ratchet 3/8" and adapter for screwdriver in blister pack 3-pcs.

24601

Order-No.	📦	📦
20783	x	1

Switch cabinet key cross shape

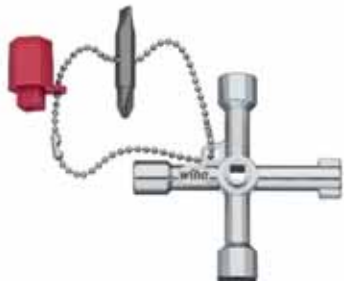

⊖

24667

Order-No.	⊖	⬆	⦿	⊖	⊕	📦
36114	5-8	9	3-5	7,0	PH2	1

Nut driver insert gripper



3/8" in blister pack

24601

Order-No.	⊖	⦿	⬆	mm	📦	📦
20554	7-19	3/8	25,4	53,5	x	1

Screwdriver with interchangeable blade set SYSTEM 6



Mixed 11-pcs. in box

284T

Order-No.	
00623	1
	Screwdriver handle SoftFinish®-telescopic for SYSTEM 6 interchangeable blade
	4,0 - 6,0 / 5,5 - 6,5
	PH1 - PH2
	PZ1 - PZ2
	T10 - T15 / T20 - T25 / T30 - T40
	4 - 4 / 5 - 5 / 6 - 6

• With ball end

Screwdriver with interchangeable blade set SYSTEM 6



Mixed 11-pcs. in roll-up bag

284T

Order-No.	
03591	1
	Screwdriver handle SoftFinish®-telescopic for SYSTEM 6 interchangeable blade
	4,0 - 6,0 / 5,5 - 6,5
	PH1 - PH2
	PZ1 - PZ2
	T10 - T15 / T20 - T25 / T30 - T40
	4 - 4 / 5 - 5 / 6 - 6

• With ball end



INFOBOX:  
SYSTEM 6



Screwdriver with interchangeable blades

- Flexible, versatile interchangeable blade system in industrial quality.
- Suitable for all applications: the blades can be quickly combined, extended and exchanged.
- Press sleeve: Blade lock is released
- Desired blade length can be set (42 – 114 mm)
- Release sleeve: Blade is held in place

Screwdriver with interchangeable blade set SYSTEM 6



Mixed 6-pcs. in roll-up bag

284T

Order-No.	
32298	1
	Screwdriver handle SoftFinish®-telescopic for SYSTEM 6 interchangeable blade
	4,0 - 6,0
	PH1 - PH2
	PZ1 - PZ2
	T10 - T15 / T20 - T25

Screwdriver with interchangeable blade set SYSTEM 6



Hex nut driver, 12-pcs. in roll-up bag

284T

Order-No.	
27713	1
	Screwdriver handle SoftFinish®-telescopic for SYSTEM 6 interchangeable blade
	4,0 - 150 / 4,5 - 150 / 5,0 - 150 / 5,5 - 150 / 6,0 - 150 / 7,0 - 150 / 8,0 - 150 / 9,0 - 150 / 10,0 - 150 / 11,0 - 150 / 13,0 - 150

Screwdriver with interchangeable blade set SYSTEM 6



Hex nut driver, 8-pcs. in roll-up bag

284T

Order-No.	
27712	1
	Screwdriver handle SoftFinish®-telescopic for SYSTEM 6 interchangeable blade
	5,0 - 150 / 5,5 - 150 / 6,0 - 150 / 7,0 - 150 / 8,0 - 150 / 10,0 - 150 / 13,0 - 150

Screwdriver with interchangeable blade set SYSTEM 6 ESD



Mixed 6-pcs. in roll-up bag

284ESD

Order-No.						
31497						1
	Screwdriver handle SoftFinish®-telescopic ESD for SYSTEM 6 interchangeable blade					
		3,5 - 4,5 / 4,0 - 6,0 / 5,5 - 6,5				
		PH1 - PH2				
		5 - 5				

• With ball end

Screwdriver handle SoftFinish®-telescopic



for SYSTEM 6 interchangeable blade

284

Order-No.						
30372	6,0	120	36			5
30404	6,0	120	36	x		5

Screwdriver handle SoftFinish®-telescopic ESD



for SYSTEM 6 interchangeable blade

284ESD

Order-No.					
31496	6,0	120	36		5

IEC 61340-5-1.

INFOBOX:  
**Electrostatic  
conductive ESD  
tools**



**Sensitive, electronic components can be damaged even at a very low voltage.**

- Dissipative tools by Wiha discharge the electrostatic energy in a controlled, safe manner.
- ESD tools meet the ESD Standard IEC 61340-5-1.
- ESD tool handles have a surface resistance of  $10^6 - 10^9$  Ohm.



**Interchangeable blade SYSTEM 6**



**Slotted**

28400

Order-No.	⊖	⊖	⊖	⊖	mm	⬮	📦
27627	3,5	4,5	0,6	0,8	150	6,0	5
00629	4,0	6,0	0,8	1,0	150	6,0	5
00630	5,5	6,5	1,0	1,2	150	6,0	5

**Slotted, Phillips**

28401

Order-No.	⊖	⊕	⊖	mm	⬮	📦
00665	4,0	PH1	0,8	150	6,0	5
00666	6,0	PH2	1,0	150	6,0	5
00667	6,5	PH3	1,2	150	6,0	5

**Phillips**

28411

Order-No.	⊕	⊕	mm	⬮	📦
00631	PH1	PH2	150	6,0	5
27628	PH2	PH3	150	6,0	5

**Pozidriv**

28422

Order-No.	⊕	⊕	mm	⬮	📦
00632	PZ1	PZ2	150	6,0	5
27629	PZ2	PZ3	150	6,0	5

**TORX®**

28455

Order-No.	⬮	⬮	mm	⬮	📦
00654	T6	T8	150	6,0	5
00655	T7	T9	150	6,0	5
00656	T10	T15	150	6,0	5
00657	T20	T25	150	6,0	5
00658	T30	T40	150	6,0	5

**TORX® Tamper Resistant (with hole)**

284TR

Order-No.	⬮	⬮	mm	⬮	📦
27630	T6H	T8H	150	6,0	5
27631	T7H	T9H	150	6,0	5
27632	T10H	T15H	150	6,0	5
27633	T20H	T25H	150	6,0	5
27634	T30H	T40H	150	6,0	5

**Ball end hex**

28437

Order-No.	⦿	⦿	mm	⬮	📦
00635	2,5	2,5	150	6,0	5
00636	3	3	150	6,0	5
00637	4•	4	150	6,0	5
00638	5•	5	150	6,0	5
00639	6•	6	150	6,0	5

**Torq-Set®**

284TS

Order-No.	⊕	⊕	mm	⬮	📦
27635	TS2	TS4	150	6,0	5
27636	TS6	TS8	150	6,0	5

**Tri-Wing® 1/4"**

284TW

Order-No.	⊕	⊕	mm	⬮	📦
27637	TW0	TW1	150	6,0	5
27638	TW2	TW3	150	6,0	5
27639	TW4	TW5	150	6,0	5

**Interchangeable blade SYSTEM 6**



**Hex nut driver**

2844

Order-No.	⦿	mm	⬮	📦
08900	4,0	150	6,0	1
08901	4,5	150	6,0	1
08902	5,0	150	6,0	1
08903	5,5	150	6,0	1
08904	6,0	150	6,0	1
08905	7,0	150	6,0	1
08906	8,0	150	6,0	1
08907	9,0	150	6,0	1
08908	10,0	150	6,0	1
08909	11,0	150	6,0	1
08911	13,0	150	6,0	1

**Bit holder SYSTEM 6 clamping with ball**



**○**

7802

Order-No.	⦿	mm	⬮	📦
03882	1/4	150	6,0	5

**Interchangeable blade SYSTEM 6**



**1/4" square adapter for nut driver inserts**

7803

Order-No.	⦿	mm	⬮	📦
03883	1/4	150	6,0	5



Screwdriver with interchangeable blade set SYSTEM 4



Mixed 11-pcs. in roll-up bag

269T

Ordern-No.	
00610	5
	Screwdriver handle SoftFinish®-telescopic for SYSTEM 4 interchangeable blade
	1,5 - 3,0 / 2,0 - 3,5 / 2,5 - 4,0
	PH000 - PH00 / PH0 - PH1
	1,3 - 1,3 / 1,5 - 1,5 / 2 - 2 / 2,5 - 2,5 / 3 - 3

• With ball end

Mixed 11-pcs. in roll-up bag

269T

Ordern-No.	
27820	1
	Screwdriver handle SoftFinish®-telescopic for SYSTEM 4 interchangeable blade
	1,5 - 3,0 / 2,0 - 3,5 / 2,5 - 4,0
	PH000 - PH00 / PH0 - PH1
	T6 - T8 / T7 - T9
	1,5 - 1,5 / 2 - 2 / 2,5 - 2,5

Screwdriver with interchangeable blade set SYSTEM 4



Slotted, Phillips, 4-pcs. in roll-up bag

269T

Ordern-No.	
00613	5
	Screwdriver handle SoftFinish®-telescopic for SYSTEM 4 interchangeable blade
	2,0 - PH00 / 3,0 - PH0 / 4,0 - PH1

Slotted, Phillips, 6-pcs. in roll-up bag

269T

Ordern-No.	
00616	5
	Screwdriver handle SoftFinish®-telescopic for SYSTEM 4 interchangeable blade
	1,5 - 3,0 / 2,0 - 3,5 / 2,5 - 4,0
	PH000 - PH00 / PH0 - PH1



INFOBOX:  
SYSTEM 4



Screwdriver with interchangeable blades

- Flexible, versatile precision interchangeable blade system for delicate fastening tasks.
- Suitable for all applications: the blades can be quickly combined, extended and exchanged.
- Press sleeve: Blade lock is released
- Press and hold sleeve: Desired blade length can be set (18 – 90 mm)
- Release sleeve: Blade is held in place

Bit set SYSTEM 4 ESD



Mixed 26-pcs. in box

269ESD

Order-No.	
33848	1
○	1 x Screwdriver handle SoftFinish®-telescopic ESD for SYSTEM 4 interchangeable blade
○	1 x Bit holder SYSTEM 4 clamping with ball
⊖	1 x 1,5 / 1 x 2,0 / 1 x 3,0 / 1 x 4,0
⊕	1 x PH000 / 1 x PH00 / 1 x PH0 / 1 x PH1
⊗	1 x T3 / 1 x T4 / 1 x T5 / 1 x T6 / 1 x T7 / 1 x T8 / 1 x T9 / 1 x T10
●	1 x 0,7 / 1 x 0,9 / 1 x 1,3 / 1 x 1,5 / 1 x 2,0 / 1 x 2,5 / 1 x 3,0 / 1 x 4,0

DIN 3126, ISO 1173, style C 4. IEC 61340-5-1.

Bit set SYSTEM 4 ESD



Mixed 16-pcs. in box

269ESD

Order-No.	
33503	1
○	1 x Screwdriver handle SoftFinish®-telescopic ESD for SYSTEM 4 interchangeable blade
○	1 x Bit holder SYSTEM 4 clamping with ball
⊖	1 x 2,0 / 1 x 3,0
⊕	1 x PH000 / 1 x PH00 / 1 x PH0 / 1 x PH1
⊗	1 x T3 / 1 x T4 / 1 x T5 / 1 x T6 / 1 x T8
●	1 x 0,9 / 1 x 1,3 / 1 x 1,5

DIN 3126, ISO 1173, style C 4. IEC 61340-5-1.

## Screwdriver with interchangeable blade set SYSTEM 4 ESD



### Mixed 11-pcs. in roll-up bag

269TESD

Order-No.	Icon		Quantity
31499	[Bag Icon]		5
○	Screwdriver handle SoftFinish®-telescopic ESD for SYSTEM 4 interchangeable blade		
⊖ ⊖	1,5 - 3,0 / 2,0 - 3,5 / 2,5 - 4,0		
⊕ ⊕	PH000 - PH00 / PH0 - PH1		
⊗ ⊗	T6 - T8 / T7 - T9		
● ●	1,5 - 1,5 / 2 - 2 / 2,5 - 2,5		

## Screwdriver handle SoftFinish®-telescopic



### ○ for SYSTEM 4 interchangeable blade

269

Order-No.	●	■	⊕	Quantity
30373	4,0	105	23	10

## Screwdriver handle SoftFinish®-telescopic ESD



### ○ for SYSTEM 4 interchangeable blade

2691ESD

Order-No.	○	■	⊕	Quantity
31498	4,0	105	23	10

IEC 61340-5-1.

## Interchangeable blade SYSTEM 4



### ⊖ Slotted

26900

Order-No.	⊖	⊖	⊖	⊖	mm	⊕	Quantity
00576	1,5	3,0	0,25	0,5	120	4,0	5
00577	2,0	3,5	0,4	0,6	120	4,0	5
00578	2,5	4,0	0,4	0,8	120	4,0	5

### ⊖ Slotted/ Phillips

26901

Order-No.	⊖	⊕	⊖	mm	⊕	Quantity
00601	2,0	PH00	0,4	120	4,0	5
00602	3,0	PH0	0,5	120	4,0	5
00603	4,0	PH1	0,8	120	4,0	5

### ⊕ Phillips

26911

Order-No.	⊕	⊕	mm	⊕	Quantity
00579	PH000	PH00	120	4,0	5
00580	PH0	PH1	120	4,0	5

### ⊗ Pozidriv

26922

Order-No.	⊗	⊗	mm	⊕	Quantity
03186	PZ0	PZ1	120	4,0	5

### ⊗ TORX®

26955

Order-No.	⊗	⊗	mm	⊕	Quantity
26122	T1	T2	120	4,0	5
26123	T3	T4	120	4,0	5
26124	T5	T6	120	4,0	5
00597	T6	T8	120	4,0	5
00598	T7	T9	120	4,0	5
00599	T10	T15	120	4,0	5
00600	T15	T20	120	4,0	5

### ● Ball end hex

26937

Order-No.	●	●	mm	⊕	Quantity
00582	1,3•	1,3	120	4,0	5
00583	1,5•	1,5	120	4,0	5
00584	2•	2	120	4,0	5
00585	2,5•	2,5	120	4,0	5
00586	3•	3	120	4,0	5
00587	4•	4	120	4,0	5

• With ball end



## L-keys

### Difficult to access - easily solved.

Wiha L-keys are essential for all users who are faced with a screw fastening task in difficult work conditions. For difficult-to-access screws Wiha L-keys with a shortened L-key arm prove themselves to be ideal. The risk of injury is significantly reduced as the hand-working space is increased by over 30%.

Wiha ball-end tools enable fastening at angles of up to 25° per side. The risk of an accident is reduced since the tool does not slip out of the screw. Screws made of steel and non-magnetic materials are securely held in any position with the Wiha MagicRing and MagicSpring.

## Application

## L-keys

### L-key holders

L-key set in ErgoStar holder hexagonal ball Magicring® 9-pcs. in flourescent colour  
Page 230



L-key set in ErgoStar holder Hexagonal ball end MagicRing® matt chrome-plated 9-pcs.  
Page 231



L-key set in ProStar holder Matt chrome-plated hexagonal ball end with short shaft, 9-pcs.  
Page 232



L-key set in ProStar holder Hexagonal ball end matt chrome-plated 9-pcs.  
Page 232



L-key set in Compact holder Hexagonal ball end, 9-pcs., short, matt chrome-plated  
Page 233



L-key set in ErgoStar holder TORX® MagicSpring®, 13-pcs., black oxidised  
Page 235



L-key set in ProStar holder Stubby TORX® ball end, 13-pcs. in titanium silver  
Page 237



L-key set in ProStar holder TORX®, 13-pcs., black oxidised  
Page 237



L-key set in Classic holder TORX®, 8-pcs., short, black oxidised  
Page 238



L-key with T-handle ComfortGrip Hexagon MagicRing® with side drive, matt chrome-plated  
Page 247



L-key with key handle TORX®, black oxidised  
Page 251

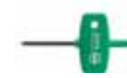

L-key with flag handle TORX®, black oxidised  
Page 252



L-key set in ErgoStar holder

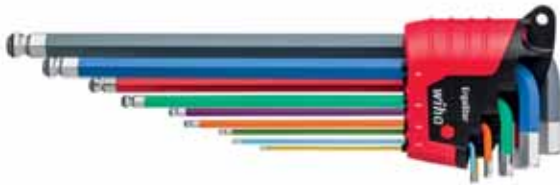

hexagonal ball Magicing® 9-pcs. in fluorescent colour

369RF

Order-No.	SB	Icon	Quantity
41979			5
43851	x		5
●			1,5 / 2 / 2,5
●			3 / 4 / 5 / 6 / 8 / 10

Magicing® from size 3 mm.  
Based on ISO 2936L.

L-key set in ErgoStar holder

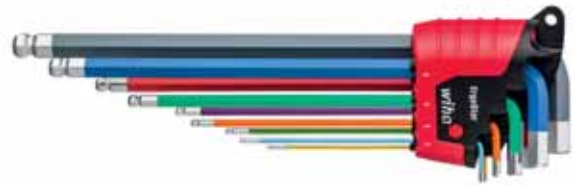

hexagonal ball end, 9-pcs. in fluorescent colour

369F

Order-No.	SB	Icon	Quantity
41483			5
43849	x		5
●			1,5 / 2 / 2,5 / 3 / 4 / 5 / 6 / 8 / 10

INFOBOX:  
Tools in fluorescent colour



- Coloured bits and ErgoStar with coloured L-keys light up under a UV light.
- Ensuring misplaced tools are quickly and easily found again.
- The Wiha flashlight with a UV light makes the perfect complement to coloured fluorescent tools.

INFOBOX:  
ErgoStar



The right L-key after just one turn.

- One turn of any L-key and all L-keys are ready for removal.
- Solid stopping point for fixing L-keys in the holder.
- Innovative clamping ensures L-keys are held firmly in both a closed and open position.
- Compact design saves space on the work bench or in the toolbox.

L-key set in ErgoStar holder



Hexagonal ball end MagicRing® matt chrome-plated  
9-pcs.

369R

Order-No.	SB	Icon	Quantity
37351			5
43850	x		5
● 1,5 / 2 / 2,5			
● 3 / 4 / 5 / 6 / 8 / 10			

MagicRing® from size 3 mm.  
Based on ISO 2936L.

L-key set in ErgoStar holder



Hexagonal ball end MagicRing® matt chrome-plated,  
inch design 13-pcs.

369RZ

Order-No.	SB	Icon	Quantity
36521			5
43852	x		5
● 0.05 / 1/16 / 5/64 / 3/32 / 7/64			
● 1/8 / 9/64 / 5/32 / 3/16 / 7/32 / 1/4 / 5/16 / 3/8			

MagicRing® from 1/8"  
Based on ASME B18.3.



INFOBOX:  
MagicRing®



Wiha MagicRing®

- Spring steel ring reliably holds hex screws in place
- An innovation, which will benefit each user.

INFOBOX:  
Ball end hex



Wiha hexagonal ball end

- The ball end can be rotated by up to 25° in both clockwise and anti-clockwise direction.

L-key set in ProStar holder



**Matt chrome-plated hexagonal ball end with short shaft, 9-pcs.**

369T

Order-No.	SB	Grid
35480		5
35481	x	5
● 1,5 / 2 / 2,5 / 3 / 4 / 5 / 6 / 8 / 10		

Based on ISO 2936L.

L-key set in ProStar holder



**Hexagonal ball end in inch design, 13-pcs., black oxidised**

369ZB

Order-No.	SB	Grid
24189		5
24851	x	5
● 0.05 / 1/16 / 5/64 / 3/32 / 7/64 / 1/8 / 9/64 / 5/32 / 3/16 / 7/32 / 1/4 / 5/16 / 3/8		

Based on ASME B18.3.

L-key set in ProStar holder



**Hexagonal ball end matt chrome-plated 9-pcs.**

369

Order-No.	SB	Grid
07185		5
07192	x	5
● 1,5 / 2 / 2,5 / 3 / 4 / 5 / 6 / 8 / 10		

Based on ISO 2936L.

**INFOBOX:**  
**L-key with short shaft**



**Especially for hard-to-reach screws and confined spaces**

- Improved accessibility thanks to a 60% reduction in length of the short L-key side.
- Increase in the hand working space of over 30% and thus a reduction of the risk of injury to the knuckles and fingertips thanks to a 95° bend of the L-key.
- Ball end geometry enables fastening at an angle of up to 25°.



L-key set in Compact holder



Hexagonal ball end matt chrome-plated 11-pcs.

369

Order-No.	SB	Icon
36453		5
36454	x	5
●	1,5 / 2 / 2,5 / 3 / 4 / 5 / 6 / 7 / 8 / 9 / 10	

Including 7 mm and 9 mm special sizes.  
Based on ISO 2936L.

L-key set in Compact holder



Hexagonal ball end, 9-pcs., short, matt chrome-plated

369K

Order-No.	SB	Icon
40410		10
40411	x	5
●	1,5 / 2 / 2,5 / 3 / 4 / 5 / 6 / 8 / 10	

Based on ISO 2936L.

L-key set in Compact holder



Hexagonal ball end matt chrome-plated 9-pcs.

369

Order-No.	SB	Icon
01418		5
02292	x	5
●	1,5 / 2 / 2,5 / 3 / 4 / 5 / 6 / 8 / 10	

Based on ISO 2936L.

L-key set in Classic holder

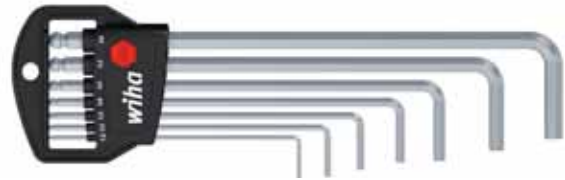

Hexagonal ball end matt chrome-plated 7-pcs.

369

Order-No.	SB	Icon
01416		5
03723	x	10
●	1,5 / 2 / 2,5 / 3 / 4 / 5 / 6	

Based on ISO 2936L.

L-key set in Classic holder

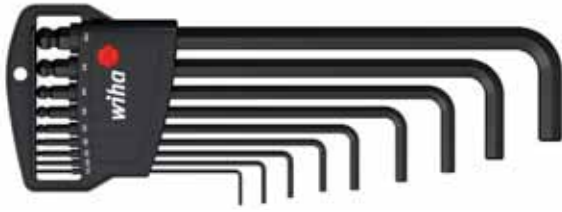

Hexagonal ball end, 9-pcs., black oxidised

369B

Order-No.		
03879		5
03992	x	10
● 1,5 / 2 / 2,5 / 3 / 4 / 5 / 6 / 8 / 10		
Based on ISO 2936L.		

L-key set in Classic holder

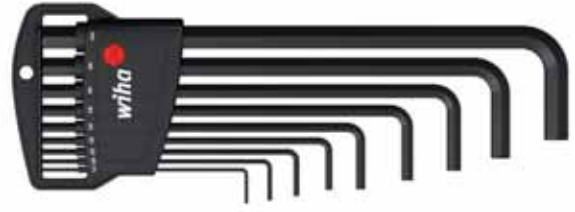

Hex, 9-pcs., black oxidised

352B

Order-No.		
06386	x	5
● 1,5 / 2 / 2,5 / 3 / 4 / 5 / 6 / 8 / 10		
Based on ISO 2936L.		

L-key set in Classic holder

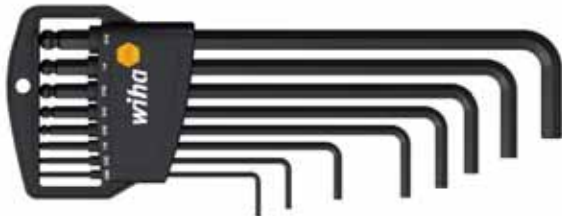

Hexagonal ball end, 8-pcs. in inch design, black oxidised

369ZB

Order-No.		
01420		5
02939	x	10
● 5/64 / 3/32 / 1/8 / 5/32 / 3/16 / 7/32 / 1/4 / 5/16		
Based on ASME B18.3.		

L-key set in Classic holder



Hex, 9-pcs., black oxidised

350

Order-No.		
06379	x	10
● 1,5 / 2 / 2,5 / 3 / 4 / 5 / 6 / 8 / 10		
ISO 2936K.		

L-key set in Classic holder



Hex, 7-pcs., black oxidised

350

Order-No.		
06378	x	10
● 1,5 / 2 / 2,5 / 3 / 4 / 5 / 6		
ISO 2936K.		

L-key set in Classic holder



Hex, 5-pcs., black oxidised

352B

Order-No.		
06382	x	10
0,7 / 0,9 / 1,3 / 1,5 / 2 Based on ISO 2936L.		

L-key set in Classic holder



TORX® MagicSpring®, 8-pcs., black oxidised

366R

Order-No.		
34740		5
34741	x	10
T9 / T10 / T15 / T20 / T25 / T27 / T30 / T40		



L-key set in ErgoStar holder



TORX® MagicSpring®, 13-pcs., black oxidised

366R

Order-No.		
36503		5
43848	x	5
T5 T6 / T7 / T8 / T9 / T10 / T15 / T20 / T25 / T27 / T30 / T40 / T45 MagicSpring® from size T6		



L-key set in Classic holder

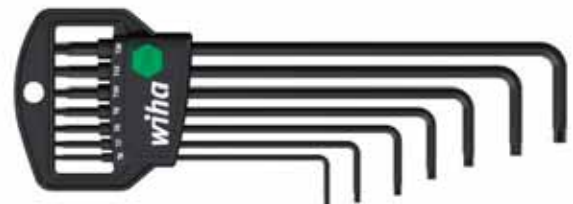

TORX® MagicSpring®, 7-pcs., black oxidised

366R

Order-No.		
33753		5
33754	x	5
T6 / T7 / T8 / T9 / T10 / T15 / T20		



INFOBOX:  
MagicSpring®



Wiha TORX® MagicSpring®

- TORX® and TORX PLUS® screws are held securely in place.
- An innovation, which will benefit each user.

L-key set in ErgoStar holder



**TORX® ball end, 13-pcs., black oxidised**

366BE

Order-No.	SB	Icon	Count
36487			5
43847	x		5
T5 / T6 / T7 / T8			
T9 / T10 / T15 / T20 / T25 / T27 / T30 / T40 / T45			

TORX® ball end from size T9

L-key set in Classic holder



**TORX® ball end, 8-pcs., black oxidised**

366BE

Order-No.	SB	Icon	Count
32394			5
32395	x		10
T9 / T10 / T15 / T20 / T25 / T27 / T30 / T40			

L-key set in ProStar holder



**Stubby TORX® ball end, 13-pcs. in titanium silver**

366BET

Order-No.	SB	Icon	Count
40979			5
40980	x		1
T5 / T6 / T7 / T8 / T9 / T10 / T15 / T20 / T25 / T27 / T30 / T40 / T45			

TORX® ball end from size T9

INFOBOX:  
**TORX® ball end**



**Wiha TORX® ball end**

- With optimised TORX® ball end geometry
- Increased strength thanks to the special cold forming on a system developed by Wiha especially for this purpose.
- Allows fastening and unfastening at angles up to 25°.
- Simple insertion of the tool/bit and fastening/unfastening, especially in hard-to-reach positions.
- Broad product range: As an L-key, as a bit and as a SoftFinish® screwdriver.

L-key set in ProStar holder



**TORX® titanium silver 13-pcs.**

366TS

Order-No.	SB	🏠
39104		5
39105	x	5

⊕ T5 / T6 / T7 / T8 / T9 / T10 / T15 / T20 /  
T25 / T27 / T30 / T40 / T45

L-key set in ProStar holder



**TORX®, 13-pcs., black oxidised**

366

Order-No.	SB	🏠
24312		5
24852	x	5

⊕ T5 / T6 / T7 / T8 / T9 / T10 / T15 / T20 /  
T25 / T27 / T30 / T40 / T50



L-key set in Classic holder

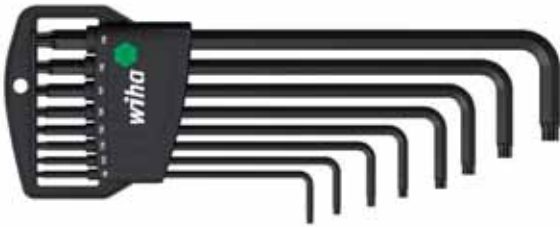

TORX®, 8-pcs., black oxidised

366

Order-No.		
34736		5
34737	x	10
	T9 / T10 / T15 / T20 / T25 / T27 / T30 / T40	

L-key set in Classic holder



TORX PLUS®, 8-pcs. in black oxidised

361IP

Order-No.		
36459	x	5
	9IP / 10IP / 15IP / 20IP / 25IP / 27IP / 30IP / 40IP	
TORX PLUS® keys cannot be used with TORX® screws.		

L-key set in Classic holder



TORX®, 8-pcs., short, black oxidised

363

Order-No.		
36461	x	5
	T9 / T10 / T15 / T20 / T25 / T27 / T30 / T40	

L-key set in Classic holder



TORX® Tamper Resistant (with hole), 8-pcs., black oxidised

363TR

Order-No.		
36462		5
36458	x	10
	T9H / T10H / T15H / T20H / T25H / T27H / T30H / T40H	

L-key set



Short TORX® in work bench stand, 9-pcs., black oxidised

363

Order-No.		
01326	x	1
	T10 / T15 / T20 / T25 / T30 / T40 / T50 / T55 / T60	

L-key with T-handle set ComfortGrip



Hexagon with side drive, matt chrome-plated 6-pcs.

334DS

Order-No.		
26247	x	1
●	2,5 / 3 / 4 / 5 / 6 / 8	

L-key with T-handle set ComfortGrip



TORX® with side drive, matt chrome-plated 6-pcs.

364DS

Order-No.		
26248	x	1
●	T10 / T15 / T20 / T25 / T30 / T40	

L-key with T-handle set



Hexagon MagicRing® brilliant nickel-plated in work bench stand 6-pcs.



334R

Order-No.		
22096	x	1
●	3 / 4 / 5 / 6 / 8 / 10	

L-key with T-handle set



Hex in work bench stand, 7-pcs., brilliant nickel-plated

334

Order-No.		
00953	x	1
●	2 / 2,5 / 3 / 4 / 5 / 6 / 8	

L-key with T-handle set



Short TORX® in work bench stand, 7-pcs., matt chrome-plated

364

Order-No.		
01348	x	1
	T10 / T15 / T20 / T25 / T30 / T40 / T50	

L-key with key handle set



TORX PLUS® in work bench stand, 7-pcs., black oxidised

365IP

Order-No.	
26261	x 1
	6IP x 35 / 7IP x 35 / 8IP x 40 / 9IP x 40 / 10IP x 40 / 15IP x 45 / 20IP x 45

L-key with key handle set



TORX® in work bench stand, 7 pcs., black oxidised

365

Order-No.	
25624	x 1
	T6 x 35 / T7 x 35 / T8 x 40 / T9 x 40 / T10 x 40 / T15 x 45 / T20 x 45

L-key with flag handle set



TORX® in work bench stand, 7 pcs., black oxidised

370

Order-No.	
25625	x 1
	T6 x 35 / T7 x 35 / T8 x 40 / T9 x 40 / T10 x 40 / T15 x 45 / T20 x 45



L-keys



● hexagonal ball MagicRing® in fluorescent colour

369RF

Order-No.	●	↔	└┘	◀C	📦
41973	3	128	23	orange	10
41974	4	142	29	purple	10
41975	5	163	33	Dark green	10
41976	6	184	38	red	10
41977	8	206	44	Dark blue	10
41978	10	231	50	Anthracite	10

Based on ISO 2936L.

L-keys



● hexagonal ball in fluorescent colour

369F

Order-No.	●	↔	└┘	◀C	📦
41894	1,5	91	15	yellow	10
41895	2	101	18	light blue	10
41896	2,5	113	20	Light green	10
41897	3	128	23	orange	10
41898	4	142	29	purple	10
41899	5	163	33	Dark green	10
41900	6	184	38	red	10
41901	8	206	44	Dark blue	10
41902	10	231	50	Anthracite	5

L-keys



● Hexagonal ball end MagicRing® matt chrome-plated

369R

Order-No.	●	↔	└┘	📦
20549	3	128	23	10
20550	4	142	29	10
20570	5	163	33	10
20551	6	184	38	10
20552	8	206	44	10
20553	10	231	50	5

Based on ISO 2936L.

L-keys



● Hexagonal ball end MagicRing®, inch design matt chrome-plated

369RZ

Order-No.	●	↔	└┘	mm	📦
24302	1/8	121	23	3,17	10
24304	9/64	136	27	3,57	10
24303	5/32	148	29	3,96	10
24305	3/16	163	33	4,76	10
24306	7/32	176	36	5,55	10
24307	1/4	191	38	6,35	10
24308	5/16	210	43	7,93	10
24341	3/8	232	49	9,52	10

Based on ASME B18.3.

L-keys



● Hexagonal ball end with short side, matt chrome-plated

369T

Order-No.	●	↔	└┘	📦
35482	1,5	91	5,5	10
35483	2	101	9	10
35484	2,5	113	9,5	10
35485	3	128	11	10
35486	4	142	13	10
35487	5	163	15	10
35488	6	184	18	10
35489	8	206	22	10
35490	10	231	28	5

Based on ISO 2936L.

L-keys



● Hexagonal ball end, short, matt chrome-plated

369K

Order-No.	●	↔	└┘	📦
40401	1,5	46	15	10
40402	2	51	18	10
40403	2,5	57	20	10
40404	3	64	23	10
40405	4	72	29	10
40406	5	83	33	10
40407	6	94	38	10
40408	8	105	44	10
40409	10	119	50	10

As per ISO 2936K.

L-keys



● Hexagonal ball end matt chrome-plated

369

Order-No.	●	↔	└┘	📦
01392	1,5	91	15	10
01393	2	101	18	10
01395	2,5	113	20	10
01396	3	128	23	10
01398	4	142	29	10
01400	5	163	33	10
01402	6	184	38	10
07922	7	195	39	5
01404	8	206	44	10
36452	9	217	47	5
01406	10	231	50	5
01408	12	259	57	5

Based on ISO 2936L.

L-keys



● Matt chrome-plated hexagonal ball end in inch design

369Z

Order-No.	●	↔	└┘	mm	📦
29471	0.05	72	13	1,27	10
29472	1/16	80	15	1,59	10
29474	5/64	88	18	1,98	10
29473	3/32	101	20	2,38	10
29475	7/64	111	21	2,78	10

Based on ASME B18.3.

L-keys



● hexagonal ball end, black oxidised

369B

Order-No.	●	↔	└┘	⊞
01391	1,3	74	14	10
05638	1,5	91	15	10
03868	2	101	18	10
03869	2,5	113	20	10
03870	3	128	23	10
03871	4	142	29	10
03872	5	163	33	10
03873	6	184	38	10
03874	8	206	44	10
03875	10	231	50	10
03876	12	259	57	10

Based on ISO 2936L.

L-keys



● Hex , black oxidised

352B

Order-No.	●	↔	└┘	⊞
06358	0,7	67	6	5
06359	0,9	70	9	5
06360	1,3	73	13	5
06059	1,5	91	15	10
06361	2	101	18	10
06362	2,5	113	20	10
06363	3	128	23	10
06364	4	142	29	10
06365	5	163	33	10
06366	6	184	38	10
06367	7	194	41	10
06368	8	206	44	10
06369	10	231	50	5
06370	12	259	57	5
06371	14	294	70	5

Based on ISO 2936L.

L-keys

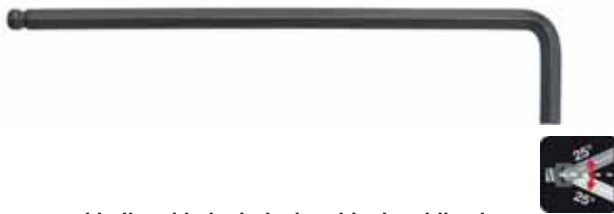

● Hexagonal ball end in inch design, black oxidised

369 Zoll B

Order-No.	●	↔	└┘	mm	⊞
01422	0.05	72	13	1,27	10
01423	1/16	80	15	1,59	10
01431	5/64	88	18	1,98	10
01427	3/32	101	20	2,38	10
01433	7/64	111	21	2,78	10
01425	1/8	121	23	3,18	10
01434	9/64	136	27	3,57	10
01430	5/32	148	29	3,97	10
01426	3/16	163	33	4,76	10
01432	7/32	176	36	5,56	10
01424	1/4	191	38	6,35	10
01429	5/16	210	43	7,94	10
01428	3/8	232	49	9,53	5

Based on ASME B18.3.



L-keys



● Hex, short, black oxidised

350

Order-No.	●	↔	└┘	⊞
06218	1,3	41	13	10
01121	1,5	46	15	10
01122	2	51	18	10
01123	2,5	57	20	10
01124	3	64	23	10
01126	4	72	29	10
01128	5	83	33	10
01130	6	94	38	10
01131	7	99	41	10
01132	8	105	44	10
01133	9	112	47	5
01134	10	119	50	5
01135	11	126	53	5
01136	12	134	57	5
01137	14	151	70	5
01138	17	173	80	5
01139	19	195	89	5
01140	22	217	102	1
01141	24	241	114	1
01142	27	271	127	1
01143	32	339	157	1

ISO 2936K.

L-keys



⊞ TORX® MagicSpring®, black oxidised

366R

Order-No.	⊞	↔	└┘	⊞	⊞
31233	T6	80	15	1/16	10
31234	T7	88	18	5/64	10
31235	T8	101	20	3/32	10
31236	T9	111	21	7/64	10
31237	T10	121	23	1/8	10
31238	T15	136	27	9/64	10
31239	T20	148	29	5/32	10
31240	T25	163	33	3/16	10
31241	T27	176	36	7/32	10
31242	T30	191	38	1/4	10
31243	T40	210	43	5/16	10
31244	T45	232	49	3/8	10

L-keys



⊞ TORX® ball end, black oxidised

366BE

Order-No.	⊞	↔	└┘	⊞	⊞
32386	T9	111	21	7/64	10
32387	T10	121	23	1/8	10
32388	T15	136	27	9/64	10
32389	T20	148	29	5/32	10
32390	T25	163	33	3/16	10
32391	T27	176	36	7/32	10
32392	T30	191	38	1/4	10
32393	T40	210	43	5/16	10
33749	T45	232	49	3/8	10
33750	T50	232	49	3/8	10

L-keys



**TORX® ball end with short handle, titanium silver**

366BET

Order-No.					
40966	T5	72	6,5	0,05	10
40967	T6	80	6,9	1/16	10
40968	T7	89	8,9	5/64	10
40969	T8	101	10,4	3/32	10
40970	T9	111	11,8	7/64	10
40971	T10	122	12,0	1/8	10
40972	T15	136	12,5	9/64	10
40973	T20	149	13,3	5/32	10
40974	T25	164,5	16,2	3/16	10
40975	T27	176	18,0	7/32	10
40976	T30	191	19,2	1/4	10
40977	T40	210	24,1	5/16	10
40978	T45	232	29,5	3/8	10

TORX® ball end from size T9

L-keys



**TORX® titanium silver**

366 TS

Order-No.					
39106	T5	72	13	0,05	10
39107	T6	80	15	1/16	10
39108	T7	88	18	5/64	10
39109	T8	101	20	3/32	10
39110	T9	111	21	7/64	10
39111	T10	121	23	1/8	10
39112	T15	136	27	9/64	10
39113	T20	148	29	5/32	10
39114	T25	163	33	3/16	10
39115	T27	176	36	7/32	10
39116	T30	191	38	1/4	10
39117	T40	210	43	5/16	10
39118	T45	232	49	3/8	10



L-keys



**TORX®**, black oxidised

366

Order-No.					
24313	T5	72	13	0,05	10
24314	T6	80	15	1/16	10
24315	T7	88	18	5/64	10
24316	T8	101	20	3/32	10
24317	T9	111	21	7/64	10
24318	T10	121	23	1/8	10
24319	T15	136	27	9/64	10
24320	T20	148	29	5/32	10
24321	T25	163	33	3/16	10
24322	T27	176	36	7/32	10
24323	T30	191	38	1/4	10
24324	T40	210	43	5/16	10
24325	T50	232	49	3/8	10

L-keys



**TORX PLUS®**, short, black oxidised

361IP

Order-No.					
24515	7IP	44	18	2,5	10
24517	8IP	47	18	2,5	10
24519	9IP	51	19	3,0	10
24521	10IP	54	20	3,0	10
24523	15IP	58	22	3,5	10
24525	20IP	62	23	4,0	10
24527	25IP	67	25	4,5	10
24529	27IP	73	27	5,5	10
24531	30IP	79	30	6,0	10
24533	40IP	88	33	7,0	10

L-keys



**TORX®**, short, black oxidised

363

Order-No.					
03764	T5	39	18	2,5	10
01310	T6	41	18	2,5	10
01311	T7	44	18	2,5	10
01312	T8	47	18	2,5	10
01313	T9	51	19	3,0	10
01314	T10	54	20	3,0	10
01315	T15	57	22	3,5	10
01316	T20	62	23	4,0	10
01317	T25	67	25	4,5	10
01318	T27	72	27	5,5	10
01319	T30	79	30	6,0	10
01320	T40	86	33	7,0	10
01321	T45	90	36	8,0	10
01322	T50	104	41	9,0	10
01323	T55	120	47	12,0	10
01324	T60	134	52	14,0	10

L-keys



**TORX® Tamper Resistant (with hole)**, short, black oxidised

363TR

Order-No.					
24107	T8H	47	18	2,5	10
24109	T9H	51	19	3,0	10
24111	T10H	54	20	3,0	10
24113	T15H	57	22	3,5	10
24115	T20H	62	23	4,0	10
24117	T25H	67	25	4,5	10
24119	T27H	72	27	5,5	10
24121	T30H	79	30	6,0	10
24123	T40H	86	33	7,0	10

L-key with T-handle ComfortGrip



● Hexagon MagicRing® with side drive, matt chrome-plated

334DSR

Order-No.	●	↔	↔	↔	↔	🏠
26135	3	100	13	80	26	10
26136	4	150	13	80	26	10
26137	5	150	17	100	32	10
26138	6	150	17	100	32	10
26139	8	200	17	100	32	10
26140	10	200	22	120	38	5

L-key with T-handle ComfortGrip



● Hex with side drive, matt chrome-plated

334DS

Order-No.	●	↔	↔	↔	↔	🏠
26164	2	100	13	80	26	10
26165	2,5	100	13	80	26	10
26166	3	100	13	80	26	10
26167	4	150	13	80	26	10
26168	5	150	17	100	32	10
26169	6	150	17	100	32	10
26170	8	200	17	100	32	10
26171	10	200	22	120	38	5

L-key with T-handle ComfortGrip



● Hexagonal ball end with side drive, matt chrome-plated

540DS

Order-No.	●	↔	↔	↔	↔	🏠
28372	3	150	13	80	26	10
28373	4	150	13	80	26	10
28374	5	150	17	100	32	10
28375	6	150	17	100	32	10
28376	8	200	17	100	32	10
28377	10	200	22	120	38	5

L-key with T-handle ComfortGrip



● TORX® with side drive, matt chrome-plated

364DS

Order-No.	●	↔	↔	↔	↔	🏠
26172	T10	100	13	80	26	10
26173	T15	100	13	80	26	10
26174	T20	100	17	100	32	10
26175	T25	150	17	100	32	10
26176	T27	150	17	100	32	10
26177	T30	150	17	100	32	10
26178	T40	150	17	100	32	10

L-key with T-handle



Hexagon MagicRing® brilliant nickel-plated

334R

Order-No.	●	↔	↔	↔	↔	🏠
22168	3	100	126	80	26	10
22170	4	150	176	80	26	10
22172	5	150	182	100	32	10
22174	6	150	182	100	32	10
21960	8	200	232	100	32	10
21962	10	200	238	120	38	10

L-key with T-handle



Hexagonal ball end brilliant nickel-plated

540

Order-No.	●	↔	↔	↔	↔	🏠
04111	4	150	176	80	26	10
04108	5	150	182	100	32	10
04105	6	150	182	100	32	10
04099	8	200	238	100	32	10
04096	10	200	238	120	38	10

L-key with T-handle



Hexagon brilliant nickel-plated

334

Order-No.	●	↔	⬡	↔	↔	↔	🏠
00904	2	100	-	126	80	26	10
00905	2	200	-	226	80	26	10
00906	2,5	100	-	126	80	26	10
00907	2,5	200	-	226	80	26	10
00908	3	100	-	126	80	26	10
00909	3	150	-	176	80	26	10
00910	3	200	-	226	80	26	10
00911	3•	350	5+	382	100	32	10
00912	4	100	-	126	80	26	10
00913	4	150	-	176	80	26	10
00914	4	200	-	226	80	26	10
00915	4•	350	5+	382	100	32	10
00916	5	100	-	132	100	32	10
00917	5	150	-	182	100	32	10
00918	5	200	-	232	100	32	10
00919	5	350	-	382	100	32	10
00921	6	100	-	132	100	32	10
00922	6	150	-	182	100	32	10
00923	6	200	-	232	100	32	10
00924	6	350	-	382	100	32	10
00926	7	200	-	232	100	32	10
00928	8	100	-	132	100	32	10
00929	8	150	-	182	100	32	10
00930	8	200	-	232	100	32	10
00931	8	350	-	382	100	32	10
00933	10	100	-	138	120	38	10
00934	10	200	-	238	120	38	10
00937	12	200	-	238	120	38	5

• Overlength with reinforced blade.



### Nut driver with T-handle



#### ● Hexagon brilliant nickel-plated

336

Order-No.	○	↔	↔	↔	↔	☑
00965	5,5	125	157	100	32	10
00966	6	125	157	100	32	10
00967	6	200	232	100	32	10
00968	7	125	157	100	32	10
00969	7	200	232	100	32	10
00971	8	125	157	100	32	10
00972	8	200	232	100	32	10
00973	8	350	382	100	32	10
00974	9	125	157	100	32	10
00975	9	200	232	100	32	10
00977	10	125	157	100	32	10
00978	10	200	232	100	32	10
00979	10	230	262	100	32	10
00980	10	350	382	100	32	10
00982	11	125	157	100	32	10
00983	11	230	262	100	32	5
00985	12	125	157	100	32	10
00986	12	230	262	100	32	5
00988	13	125	157	100	32	10
00989	13	230	262	100	32	10
00990	13	350	382	100	32	10
00991	14	125	157	100	32	5
00993	15	125	157	100	32	5
00994	16	125	157	100	32	5
00995	17	125	157	100	32	5

### Nut driver with T-handle



#### ○ Square nickel-plated

338

Order-No.	○	↔	↔	↔	↔	☑
01005	6	125	157	100	32	10
01006	8	125	157	100	32	10
01007	10	125	157	100	32	10
01008	12	125	157	100	32	10

### L-key with T-handle



#### ● Hex, inch design brilliant nickel-plated

334Z

Order-No.	●	↔	↔	↔	↔	mm	☑
02802	3/32	150	176	80	26	2,38	10
02803	7/64	150	176	80	26	2,78	10
02804	1/8	150	176	80	26	3,18	10
02805	9/64	150	176	80	26	3,57	10
02806	5/32	150	176	80	26	3,97	10
02807	3/16	150	182	100	32	4,76	10
02808	7/32	150	182	100	32	5,56	10
02809	1/4	150	182	100	32	6,35	10
02810	5/16	150	182	100	32	7,94	10
02811	3/8	150	188	120	38	9,53	10

### Nut driver with T-handle



#### Hex, inch design brilliant nickel-plated

336Z

Order-No.	⌀	↔	↔	↔	↔	mm	📄
02819	3/16	150	182	100	32	4,76	10
02820	1/4	150	182	100	32	6,35	10
02821	5/16	150	182	100	32	7,94	10
02822	3/8	150	182	100	32	9,53	10
02823	7/16	150	182	100	32	11,11	10
02824	1/2	150	182	100	32	12,70	10

### Nut driver with T-handle electric



#### Hex

336N

Order-No.	⌀	↔	↔	↔	↔	📄
27932	8	200	232	100	32	10
27933	10	230	262	100	32	10
27934	13	230	262	100	32	10
27935	17	230	268	120	38	10

Manufactured acc. to IEC 60900.

### L-key with T-handle electric



#### Hex

334N

Order-No.	⌀	↔	↔	↔	↔	📄
27928	4	150	176	80	26	10
27929	5	150	182	100	32	10
27930	6	150	182	100	32	10
27931	8	150	182	100	32	10

Manufactured acc. to IEC 60900.

### L-key with T-handle



#### TORX® matt chrome-plated

364

Order-No.	⌀	↔	⌀	↔	↔	↔	📄
01328	T9	100	4,0	126	80	26	10
01329	T10	100	4,0	126	80	26	10
01330	T15	100	4,0	126	80	26	10
01331	T15	200	5,5	226	80	26	10
01332	T20	100	4,0	132	100	32	10
01333	T20	200	5,5	232	100	32	10
01334	T25	100	4,5	132	100	32	10
01335	T25	200	5,5	232	100	32	10
01336	T27	100	5,5	132	100	32	10
01337	T27	200	5,5	232	100	32	5
01338	T30	100	6,0	132	100	32	10
01339	T30	200	6,0	232	100	32	5
01340	T40	100	7,0	132	100	32	10
01341	T40	200	7,0	232	100	32	5
01343	T45	250	8,0	288	120	38	5
01345	T50	250	9,0	288	120	38	5

L-key with T-handle



**TORX® MagicSpring® matt chrome-plated**

364R

Order-No.	⊕	↔	●	↔	—	—	📦
27964	T9	100	4,0	126	80	26	10
27965	T10	100	4,0	126	80	26	10
27966	T15	100	4,0	126	80	26	10
27967	T20	100	4,0	132	100	32	10
27968	T25	100	5,0	132	100	32	10
27969	T27	100	6,0	132	100	32	10
27970	T30	100	6,0	132	100	32	10
27971	T40	100	8,0	132	100	32	10

L-key with T-handle



**TORX PLUS® matt chrome-plated**

364IP

Order-No.	⊕	↔	●	↔	—	—	📦
26953	9IP	100	4,0	126	80	26	10
26954	10IP	100	4,0	126	80	26	10
26955	15IP	100	4,0	126	80	26	10
26956	20IP	100	4,0	132	100	32	10
26957	25IP	150	4,5	182	100	32	10
26958	27IP	150	5,5	182	100	32	10
26959	30IP	150	6,0	182	100	32	10
26960	40IP	150	7,0	182	100	32	10

L-key with key handle



**Hex , black oxidised**

331

Order-No.	●	↔	↔	—	📦
00894	1,5	60	95	40	10
00895	2	60	95	40	10
00896	2,5	60	95	40	10
00897	3	60	95	40	10

L-key with key handle



**TORX®, black oxidised**

365

Order-No.	⊕	↔	●	↔	—	📦
04918	T5	35	2,0	70	40	10
01350	T6	35	2,0	70	40	10
01351	T7	35	2,5	70	40	10
01352	T8	40	2,5	75	40	10
01353	T9	40	3,0	75	40	10
01354	T10	40	3,0	75	40	10
01355	T15	45	3,5	80	40	10
01356	T20	45	4,0	80	40	10

L-key with key handle



**TORX PLUS®, black oxidised**

365IP

Order-No.	●	↔	●	↔	—	📦
26181	5IP	35	2,0	70	40	10
26182	6IP	35	2,0	70	40	10
26183	7IP	35	2,5	70	40	10
26184	8IP	40	2,5	75	40	10
26185	9IP	40	3,0	75	40	10
26186	10IP	40	3,0	75	40	10
26187	15IP	45	3,5	80	40	10
26188	20IP	45	4,0	80	40	10

L-key with flag handle



**TORX PLUS®, black oxidised**

370IP

Order-No.	●	↔	●	↔	—	📦
27614	5IP	35	2,0	67	15	10
27615	6IP	35	2,0	67	15	10
27616	7IP	35	2,5	67	19	10
27617	8IP	40	2,5	72	19	10
27618	9IP	40	3,0	74	24	10
27619	10IP	40	3,0	74	24	10
27620	15IP	45	3,5	80	28	10
27621	20IP	45	4,0	80	28	10

L-key with flag handle



**TORX®, black oxidised**

370

Order-No.	●	↔	●	↔	—	📦
03724	T5	35	2,0	62	15	10
03725	T6	35	2,0	62	15	10
03726	T7	35	2,5	67	19	10
03727	T8	40	2,5	72	19	10
03728	T9	40	3,0	74	24	10
03729	T10	40	3,0	74	24	10
03730	T15	45	3,5	80	28	10
03731	T20	45	4,0	80	28	10





## Bits

### The indispensable three.





Which machine? Which application? Which bit? The revolutionary Wiha bit concept puts an end to any confusion and presents three bit types which can cover all areas of use.

Only the screw shape is crucial for selecting the bit. The Y bit is ideal for fastening Y-shaped screws with an angle no greater than  $90^\circ$  between the thread and screw head. The T bit is used for T-shaped screws at a  $90^\circ$  angle. If you need to fasten both screw types, then the TY bit is the right choice since this universal bit is suitable for all type of fastenings.

A selection of different bit holders and bit boxes such as the BitBuddy® and XLSelector ensures optimum usage of bits.

## Application

## Bits

<p><b>For all screw types</b></p>	<p><b>BitBuddy® TY bit set, 49 mm</b> Page 256</p> 	<p><b>BitBuddy® TY bit set, 29 mm</b> Page 257</p> 	<p><b>TY bit set 49 mm</b> Page 256</p> 	<p><b>TY bit set 29 mm</b> Page 258</p> 
<p><b>For T-shaped screws</b></p>	<p><b>XLSelector T bit set, 50 mm</b> Page 258</p> 	<p><b>FlipSelector T bit set, 25 mm</b> Page 259</p> 	<p><b>T bit set, 50 mm</b> Page 259</p> 	<p><b>T bit set, 25 mm</b> Page 260</p> 
<p><b>For Y-shaped screws</b></p>	<p><b>XLSelector Y bit set, 50 mm</b> Page 260</p> 	<p><b>FlipSelector Y bit set, 25 mm</b> Page 261</p> 	<p><b>Y bit set, 50 mm</b> Page 261</p> 	<p><b>Y bit set, 25 mm</b> Page 261</p> 
<p><b>For universal applications</b></p>	<p><b>Bit set XLSelector Standard 25 mm</b> Page 262</p> 	<p><b>Bit set FlipSelector Standard 25 mm</b> Page 262</p> 	<p><b>Bit Standard 25 mm 1/4"</b> Page 265</p> 	<p><b>Bit Professional 1/4"</b> Page 270</p> 
<p><b>MicroBits</b></p>	<p><b>Micro-bit set ESD Mixed 65-pcs. in box</b> Page 274</p> 	<p><b>Micro-bit 28 mm</b> Page 275</p> 		
<p><b>Bit holder</b></p>	<p><b>Bit holder CentroFix Force mechanically lockable 1/4", magnetic</b> Page 280</p> 	<p><b>Bit holder CentroFix Super Slim mechanically lockable 1/4", magnetic</b> Page 280</p> 	<p><b>Bit holder MagicFlip Force magnetic with ring magnet, 1/4"</b> Page 280</p> 	<p><b>Screwdriver with SoftFinish® CentroFix bit holder, mechanically lockable 1/4"</b> Page 282</p> 
<p><b>Special solutions</b></p>	<p><b>Combination drill bit set</b> Page 277</p> 	<p><b>Countersink bit 1/4"</b> Page 277</p> 	<p><b>High-performance offset screwdriver with quick release holder 1/4"1/4"</b> Page 283</p> 	



BitBuddy® TY bit set, 49 mm



**Pozidriv 1/4" 7-pcs.**

SB 7946-TY202

Order-No.	
42099	6
1 x PZ1 / 5 x PZ2 / 1 x PZ3	
*compared to Wiha standard bit	

**TORX® 1/4" 7-pcs.**

SB 7946-TY505

Order-No.	
42115	6
1 x T10 / 1 x T15 / 2 x T20 / 1 x T25 / 1 x T30 / 1 x T40	
*compared to Wiha standard bit	

**Hexagon 1/4" 7-pcs.**

SB 7946-TY303

Order-No.	
42114	6
2 x SW3 / 2 x SW4 / 2 x SW5 / 1 x SW6	
*compared to Wiha standard bit	

**Phillips, Pozidriv, TORX®, 7-pcs., 1/4"**

SB 7946-TY903

Order-No.	
42116	6
1 x PH2	
1 x PZ1 / 1 x PZ2 / 1 x PZ3	
1 x T15 / 1 x T20 / 1 x T25	
*compared to Wiha standard bit	

**Phillips, Pozidriv, TORX®, 7-pcs., 1/4"**

SB 7946-TY904

Order-No.	
42117	6
1 x PH2	
1 x PZ1 / 1 x PZ2	
1 x T10 / 1 x T15 / 1 x T20 / 1 x T25	
*compared to Wiha standard bit	

**Pozidriv, TORX® 7-pcs. 1/4" in box**

SB 7946-TY905

Order-No.	
42118	6
1 x PZ2 / 1 x PZ3	
1 x T15 / 1 x T20 / 1 x T25 / 1 x T30 / 1 x T40	
*compared to Wiha standard bit	

TY bit set 49 mm



Order-No.		
42097	5 x PH1	6
42119	5 x PH2	6
42120	5 x PH3	6
42121	5 x PZ1	6
42122	5 x PZ2	6
42123	5 x PZ3	6
42124	5 x SW3	6
42125	5 x SW4	6
42126	5 x SW5	6
42127	5 x SW6	6
42128	5 x T10	6
42129	5 x T15	6
42130	5 x T20	6
42131	5 x T25	6
42132	5 x T27	6
42133	5 x T30	6
42134	5 x T40	6

INFOBOX:  
BitBuddy 29



**Easy, single-hand operation.**

**Attaching:**

- Bits are directly picked up with the machine from the BitBuddy.

**Work:**

- Gets your fastenings done.

**Storing**

- Bits are easily returned to the BitBuddy, by pressing on the red bit strip.
- With magnetic bit holder for a rapid bit change.
- BitBuddy is always at hand - easily fits into trouser pockets or onto the belt clip.





**Pozidriv 1/4" 8-pcs.**

SB 7945-TY202

Order-No.	
42098	6
	1 x PZ1 / 5 x PZ2 / 1 x PZ3
	1 x Bit holder magnetic extra strong magnet 1/4"
•compared to Wiha standard bit	

**TORX® 1/4" 8-pcs.**

SB 7945-TY505

Order-No.	
42136	6
	1 x T10 / 1 x T15 / 2 x T20 / 1 x T25 / 1 x T30 / 1 x T40
	1 x Bit holder magnetic extra strong magnet 1/4"
•compared to Wiha standard bit	

**Hexagon 8-pcs. 1/4"**

SB 7945-TY303

Order-No.	
42135	6
	2 x SW3 / 2 x SW4 / 2 x SW5 / 1 x SW6
	1 x Bit holder magnetic extra strong magnet 1/4"
•compared to Wiha standard bit	

**Phillips, Pozidriv, TORX®, 8-pcs., 1/4"**

SB 7945-TY903

Order-No.	
42137	6
	1 x PH2
	1 x PZ1 / 1 x PZ2 / 1 x PZ3
	1 x T15 / 1 x T20 / 1 x T25
	1 x Bit holder magnetic extra strong magnet 1/4"
•compared to Wiha standard bit	

**Phillips, Pozidriv, TORX®, 8-pcs., 1/4"**

SB 7945-TY904

Order-No.	
42138	6
	1 x PH2
	1 x PZ1 / 1 x PZ2
	1 x T10 / 1 x T15 / 1 x T20 / 1 x T25
	1 x Bit holder magnetic extra strong magnet 1/4"
•compared to Wiha standard bit	

**Pozidriv, TORX® 1/4" 8-pcs.**

SB 7945-TY905

Order-No.	
42139	6
	1 x PZ2 / 1 x PZ3
	1 x T15 / 1 x T20 / 1 x T25 / 1 x T30 / 1 x T40
	1 x Bit holder magnetic extra strong magnet 1/4"
•compared to Wiha standard bit	

**INFOBOX:  
Wiha TY bit concept**



- Bits quickly and easily selected thanks to the screw head shape.
- The T bit is ideal for fastening T-shaped screws with an angle of 90°.
- The Y bit is ideal for fastening Y-shaped screws with an angle not equal to 90°.
- Universal in its use, the TY bit is suitable for all types of screws, no matter whether they feature a Y-shaped or T-shaped screw head.

**Bitfinder**

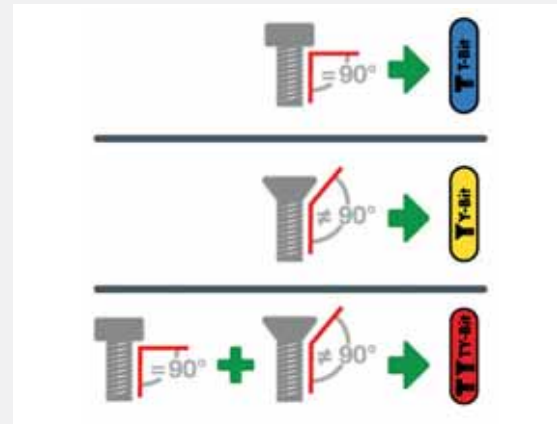

**TY bit set 29 mm**



Order-No.		
42096	⊕ 5 x PH1	6
42100	⊕ 5 x PH2	6
42101	⊕ 5 x PH3	6
42149	⊕ 5 x PZ1	6
42102	⊕ 5 x PZ2	6
42103	⊕ 5 x PZ3	6
42104	● 5 x SW3	6
42105	● 5 x SW4	6
42106	● 5 x SW5	6
42107	● 5 x SW6	6
42108	⊕ 5 x T10	6
42109	⊕ 5 x T15	6
42110	⊕ 5 x T20	6
42111	⊕ 5 x T25	6
42112	⊕ 5 x T27	6
42113	⊕ 5 x T30	6
42150	⊕ 5 x T40	6

**in bulk pack**

Order-No.		
42539	⊕ 25 x PH2	1
42551	⊕ 25 x PZ2	1
42548	⊕ 25 x T20	1
42549	⊕ 25 x T25	1
42550	⊕ 25 x T30	1

**XLSelector T bit set, 50 mm**



**Phillips, TORX®, hex 13-pcs. 1/4"**

SB 7948-T950

Order-No.		
41831		6
⊕	1 x PH1 / 1 x PH2 / 1 x PH3	
⊕	1 x T15 / 1 x T20 / 1 x T25 / 1 x T30 / 1 x T40	
●	1 x SW3 / 1 x SW4 / 1 x SW5 / 1 x SW6	
○	1 x Bit holder magnetic extra strong magnet, 1/4"	

•compared to Wiha standard bit

**XLSelector T bit set, 25 mm**



**Phillips, TORX®, hex 31-pcs. 1/4"**

SB 7948-T999

Order-No.		
41830		6
⊕	2 x PH1 / 4 x PH2 / 2 x PH3	
⊕	2 x T10 / 2 x T15 / 4 x T20 / 2 x T25 / 2 x T30 / 2 x T40	
●	2 x SW3 / 2 x SW4 / 2 x SW5 / 2 x SW6	
○	1 x Bit holder magnetic extra strong magnet, 1/4"	

•compared to Wiha standard bit

FlipSelector T bit set, 25 mm



T bit set, 50 mm



Hexagon 16-pcs. 1/4"

SB 7947-T303

Order-No.	Icon	Quantity
41825		6
	3 x SW3 / 3 x SW4 / 3 x SW5 / 3 x SW6	
	1 x Bit holder magnetic extra strong magnet 1/4"	

•compared to Wiha standard bit

Phillips, Pozidriv, TORX®, 13-pcs., 1/4"

SB 7947-T906

Order-No.	Icon	Quantity
41824		6
	1 x PH1 / 3 x PH2 / 1 x PH3	
	1 x PZ2	
	1 x T10 / 1 x T15 / 1 x T20 / 1 x T25 / 1 x T30 / 1 x T40	
	1 x Bit holder magnetic extra strong magnet 1/4"	

•compared to Wiha standard bit

assorted 1/4" 13-pcs.

SB 7947-T999

Order-No.	Icon	Quantity
41826		6
	1 x PH1 / 1 x PH2 / 1 x PH3	
	1 x PZ2	
	1 x T15 / 1 x T20 / 1 x T25 / 1 x T30 / 1 x T40	
	1 x SW4 / 1 x SW5 / 1 x SW6	
	1 x Bit holder magnetic extra strong magnet 1/4"	

•compared to Wiha standard bit

Order-No.	Icon	Quantity
41637		6
41638		6
41639		6
41640		6
41641		6
41642		6
41650		6
41651		6
41652		6
41653		6
41643		6
41644		6
41645		6
41646		6
41647		6
41648		6
41649		6
41660		6
41662		6
41663		6



## T bit set, 25 mm



Order-No.		
41598	⊕ 5 x PH1	6
41599	⊕ 5 x PH2	6
41600	⊕ 5 x PH3	6
41601	⊕ 5 x PZ1	6
41602	⊕ 5 x PZ2	6
41603	⊕ 5 x PZ3	6
41611	● 5 x SW3	6
41612	● 5 x SW4	6
41613	● 5 x SW5	6
41614	● 5 x SW6	6
41604	⊕ 5 x T10	6
41605	⊕ 5 x T15	6
41606	⊕ 5 x T20	6
41607	⊕ 5 x T25	6
41608	⊕ 5 x T27	6
41609	⊕ 5 x T30	6
41610	⊕ 5 x T40	6
41621	⊖ 5 x #1	6
41622	⊖ 5 x #2	6
41623	⊖ 5 x #3	6

### in bulk pack

Order-No.		
42292	⊕ 25 x PH2	1
42293	⊕ 25 x PZ2	1
42301	⊕ 25 x T20	1
42306	⊕ 25 x T25	1
42302	⊕ 25 x T30	1

## XLSelector Y bit set, 50 mm



### Phillips, Pozidriv, TORX®, 13-pcs., 1/4"

SB 7948-Y950

Order-No.		
41834		6
⊕	2 x PH2	
⊕	1 x PZ1 / 2 x PZ2 / 1 x PZ3	
⊕	1 x T10 / 1 x T15 / 1 x T20 / 1 x T25 / 1 x T30 / 1 x T40	
○	1 x Bit holder magnetic extra strong magnet, 1/4"	

•compared to Wiha standard bit

## XLSelector Y bit set, 25 mm



### TORX® 31-pcs. 1/4"

SB 7948-Y505

Order-No.		
41833		6
⊕	3 x T10 / 6 x T15 / 6 x T20 / 6 x T25 / 6 x T30 / 3 x T40	
○	1 x Bit holder magnetic extra strong magnet 1/4"	

•compared to Wiha standard bit

### Phillips, Pozidriv, TORX®, 31-pcs., 1/4"

SB 7948-Y904

Order-No.		
41832		6
⊕	1 x PH1 / 4 x PH2 / 1 x PH3	
⊕	2 x PZ1 / 4 x PZ2 / 2 x PZ3	
⊕	2 x T10 / 3 x T15 / 3 x T20 / 3 x T25 / 3 x T30 / 2 x T40	
○	1 x Bit holder magnetic extra strong magnet 1/4"	

•compared to Wiha standard bit

## FlipSelector Y bit set, 25 mm



### Pozidriv 1/4" 13-pcs.

SB 7947-Y202

Order-No.		
41829		6
	⊕ 2 x PZ1 / 8 x PZ2 / 2 x PZ3	
	○ 1 x Bit holder magnetic extra strong magnet 1/4"	

### TORX® 1/4" 13-pcs.

SB 7947-Y505

Order-No.		
41828		6
	⊗ 2 x T10 / 2 x T15 / 3 x T20 / 2 x T25 / 2 x T30 / 1 x T40	
	○ 1 x Bit holder magnetic extra strong magnet 1/4"	

### Phillips, Pozidriv, TORX®, 13-pcs., 1/4"

SB 7947-Y904

Order-No.		
41827		6

## Y bit set, 50 mm



Order-No.		
41624	⊕ 5 x PH1	6
41625	⊕ 5 x PH2	6
41626	⊕ 5 x PH3	6
41627	⊗ 5 x PZ1	6
41628	⊗ 5 x PZ2	6
41629	⊗ 5 x PZ3	6
41630	⊗ 5 x T10	6
41631	⊗ 5 x T15	6
41632	⊗ 5 x T20	6
41633	⊗ 5 x T25	6
41634	⊗ 5 x T27	6
41635	⊗ 5 x T30	6
41636	⊗ 5 x T40	6

## Y bit set, 25 mm



Order-No.		
41585	⊕ 5 x PH1	6
41586	⊕ 5 x PH2	6
41587	⊕ 5 x PH3	6
41588	⊗ 5 x PZ1	6
41589	⊗ 5 x PZ2	6
41590	⊗ 5 x PZ3	6
41591	⊗ 5 x T10	6
41592	⊗ 5 x T15	6
41593	⊗ 5 x T20	6
41594	⊗ 5 x T25	6
41595	⊗ 5 x T27	6
41596	⊗ 5 x T30	6
41597	⊗ 5 x T40	6

### in bulk pack

Order-No.		
42294	⊕ 25 x PH2	1
42295	⊗ 25 x PZ2	1
42303	⊗ 25 x T20	1
42304	⊗ 25 x T25	1
42305	⊗ 25 x T30	1

## Belt clip



### for bit set BitBuddy® and FlipSelector

7945

Order-No.		
36990		10

**Bit set XLSelector Standard 25 mm**



**assorted with bit ratchet form C 6.3 (1/4"), 17-pcs. 7948-043**

Order-No.	
36951	5
	1 x PH1 / 1 x PH2
	1 x PZ1 / 1 x PZ2 / 1 x PZ3
	1 x T10 / 1 x T15 / 1 x T20 / 1 x T25 / 1 x T30 / 1 x T40
	1 x 3,0 / 1 x 4,0 / 1 x 5,0 / 1 x 6,0
	1 x Bit holder magnetic, 58 mm 1/4"
	1 x Bit ratchet 90 mm with thumb wheel Hexagon head, 1/4" in blister pack

**Bit set XLSelector Standard 25 mm**



**assorted 1/4" 31-pcs. 7948-005**

Order-No.	
29417	5
	1 x 4,5 / 1 x 5,5 / 1 x 6,5
	2 x PH1 / 4 x PH2 / 1 x PH3
	2 x PZ1 / 5 x PZ2 / 1 x PZ3
	2 x T10 / 2 x T15 / 2 x T20 / 3 x T25 / 2 x T30 / 1 x T40
	1 x Bit holder magnetic, 58 mm 1/4"

**assorted 1/4" 31-pcs. 7948-927**

Order-No.	
29416	5
	1 x 0 / 1 x 1 / 1 x 2 / 1 x 3 / 1 x 4
	1 x 4 / 1 x 6 / 1 x 8 / 1 x 10
	1 x TR2,0 / 1 x TR2,5 / 1 x TR3,0 / 1 x TR4,0 / 1 x TR5,0 / 1 x TR6,0
	1 x 6 / 1 x 8 / 1 x 10
	1 x T8H / 1 x T9H / 1 x T10H / 1 x T15H / 1 x T20H / 1 x T25H / 1 x T27H / 1 x T30H / 1 x T40H
	1 x #1 / 1 x #2 / 1 x #3
	1 x CentroFix quick release holder, magnetic, style E 6.3.

**Bit set FlipSelector Standard 25 mm**



**assorted 1/4" 13-pcs. 7947-999**

Order-No.	
39078	10
	1 x 5,5
	1 x PH2
	1 x PZ1 / 1 x PZ2 / 1 x PZ3
	1 x T15 / 1 x T20 / 1 x T25 / 1 x T30
	1 x 3,0 / 1 x 4,0 / 1 x 5,0
	1 x Bit holder magnetic, 58 mm 1/4"

**Slotted, Phillips, Pozidriv 1/4" 13-pcs. 7947-005**

Order-No.	
39029	10
	1 x 5,5
	1 x PH1 / 3 x PH2 / 1 x PH3
	1 x PZ1 / 4 x PZ2 / 1 x PZ3
	1 x Bit holder magnetic, 58 mm 1/4"

**Phillips, Pozidriv, TORX®, 13-pcs., 1/4" 7947-904**

Order-No.	
39040	10
	2 x PH2
	1 x PZ1 / 2 x PZ2 / 1 x PZ3
	1 x T10 / 1 x T15 / 1 x T20 / 1 x T25 / 1 x T30 / 1 x T40
	1 x Bit holder magnetic, 58 mm 1/4"

**Pozidriv, TORX® 1/4" 13-pcs. 7947-905**



Order-No.	
39041	10
	1 x PZ1 / 2 x PZ2 / 1 x PZ3
	1 x T10 / 1 x T15 / 2 x T20 / 2 x T25 / 1 x T30 / 1 x T40
	1 x Bit holder magnetic, 58 mm 1/4"

**TORX® 1/4" 13-pcs. 7947-505**

Order-No.	
39124	10
	1 x T7 / 1 x T8 / 1 x T9 / 1 x T10 / 2 x T15 / 2 x T20 / 2 x T25 / 1 x T30 / 1 x T40
	1 x Bit holder magnetic, 58 mm 1/4"



**TORX® Tamper Resistant (with hole) 1/4" 13-pcs.**

7947-505TR

Order-No.	
39037	10
	1 x T7H / 1 x T8H / 1 x T9H / 1 x T10H / 2 x T15H / 2 x T20H / 2 x T25H / 1 x T30H / 1 x T40H
	1 x Bit holder magnetic, 58 mm 1/4"



**Hexagon 1/4" 11-pcs.**

7947-902

Order-No.	
39039	10
	1 x 1,5 / 1 x 2,0 / 1 x 2,5 / 2 x 3,0 / 2 x 4,0 / 1 x 5,0 / 1 x 6,0 / 1 x 8,0
	1 x Bit holder magnetic, 58 mm 1/4"

**SIT (for Assy® and Pias screws), 13-pcs., 1/4"**

7947-995





Order-No.	
39045	10
	2 x SIT 10 / 4 x SIT 20 / 3 x SIT 25 / 2 x SIT 30 / 1 x SIT 40
	1 x Bit holder magnetic, 58 mm 1/4"

**Bit set FlipSelector Standard 25 mm**





**Slotted, Phillips, Pozidriv, 13-pcs., 1/4" with belt clip, in blister pack**

SB 7947-005

Order-No.	
39049	5
	1 x 5,5
	1 x PH1 / 3 x PH2 / 1 x PH3
	1 x PZ1 / 4 x PZ2 / 1 x PZ3
	1 x Bit holder magnetic, 58 mm 1/4"



**TORX®, 13-pcs., 1/4" with belt clip, in blister pack**

SB 7947-505

Order-No.	
39056	5
	1 x T7 / 1 x T8 / 1 x T9 / 1 x T10 / 2 x T15 / 2 x T20 / 2 x T25 / 1 x T30 / 1 x T40
	1 x Bit holder magnetic, 58 mm 1/4"



**TORX® Tamper Resistant (with drill hole), 13-pcs., 1/4" with belt clip, in blister pack**

SB 7947-505TR

Order-No.	
39057	5
	1 x T7H / 1 x T8H / 1 x T9H / 1 x T10H / 2 x T15H / 2 x T20H / 2 x T25H / 1 x T30H / 1 x T40H
	1 x Bit holder magnetic, 58 mm 1/4"





**Hex, 11-pcs., 1/4" with belt clip in blister pack**

SB 7947-902

Order-No.	
39059	5
	1 x 1,5 / 1 x 2,0 / 1 x 2,5 / 2 x 3,0 / 2 x 4,0 / 1 x 5,0 / 1 x 6,0 / 1 x 8,0
	1 x Bit holder magnetic, 58 mm 1/4"







**Phillips, Pozidriv, TORX®, 13-pcs., 1/4" with belt clip, in blister pack**

SB 7947-904

Order-No.	
39060	5
	2 x PH2
	1 x PZ1 / 2 x PZ2 / 1 x PZ3
	1 x T10 / 1 x T15 / 1 x T20 / 1 x T25 / 1 x T30 / 1 x T40
	1 x Bit holder magnetic, 58 mm 1/4"

**Mixed, 1/4", 13-pcs. with belt clip in blister pack**

SB 7947-999

Order-No.	
39083	5
	1 x 5,5
	1 x PH2
	1 x PZ1 / 1 x PZ2 / 1 x PZ3
	1 x T15 / 1 x T20 / 1 x T25 / 1 x T30
	1 x 3,0 / 1 x 4,0 / 1 x 5,0
	1 x Bit holder magnetic, 58 mm 1/4"





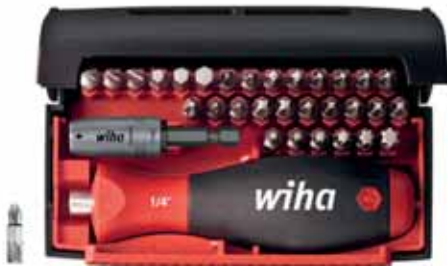





Bit set Collector Standard 25 mm



Mixed, 32-pcs. in box, 1/4"

7928-913









Order-No.	
34686	5
	1 x 4,5 / 1 x 5,5 / 1 x 6,5
	2 x PH1 / 5 x PH2 / 2 x PH3
	2 x PZ1 / 5 x PZ2 / 2 x PZ3
	1 x T10 / 1 x T15 / 1 x T20 / 1 x T25 / 1 x T30 / 1 x T40
	1 x 4,0 / 1 x 5,0 / 1 x 6,0
	1 x Bit holder CentroFix Force mechanically lockable 1/4", magnetic
	1 x Screwdriver with bit holder SoftFinish® magnetic 1/4"

Bit set Collector Security Standard 25 mm



Mixed, 27-pcs. in box, 1/4"

7928-928







Order-No.	
09393	5
	1 x T8H / 1 x T10H / 1 x T15H / 1 x T20H / 1 x T25H / 1 x T27H / 1 x T30H / 1 x T40H
	1 x 6 / 1 x 8 / 1 x 10
	1 x 1 / 1 x 2 / 1 x 3 / 1 x 4
	1 x 4 / 1 x 6 / 1 x 8 / 1 x 10
	1 x TR5/64 / 1 x TR3/32 / 1 x TR7/64 / 1 x TR1/8 / 1 x TR9/64 / 1 x TR5/32
	1 x Bit holder magnetic extra strong magnet, 1/4"
	1 x Screwdriver with bit holder SoftFinish® magnetic 1/4"

Bit set Collector Standard 25 mm



Mixed, 61-pcs. in box, 1/4"

7928-923

Order-No.	
07943	5
	1 x 4,5 / 1 x 5,5 / 1 x 6,5 / 1 x 8,0
	7 x PH1 / 13 x PH2 / 3 x PH3
	7 x PZ1 / 13 x PZ2 / 3 x PZ3
	1 x T10 / 1 x T15 / 1 x T20 / 1 x T25 / 1 x T30 / 1 x T40
	1 x 3,0 / 1 x 4,0 / 1 x 5,0 / 1 x 6,0
	1 x Bit holder CentroFix Force mechanically lockable 1/4", magnetic



**Bit set Standard 25 mm**



**assorted, 31-pcs. in box, 1/4"**

7979-01

Order-No.	Icon	Quantity
26252		1
	1 x 4,5 / 1 x 5,5 / 1 x 6,5	
	2 x PH1 / 6 x PH2 / 1 x PH3	
	2 x PZ1 / 6 x PZ2 / 1 x PZ3	
	1 x T10 / 1 x T15 / 1 x T20 / 1 x T25 / 1 x T30 / 1 x T40	
	1 x 4,0 / 1 x 5,0 / 1 x 6,0	
	1 x Bit holder magnetic extra strong magnet 1/4"	

**31-pcs. in box, 1/4"**

7979-02

Order-No.	Icon	Quantity
26253		1
	5 x PZ1 / 10 x PZ2 / 3 x PZ3	
	2 x T10 / 2 x T15 / 2 x T20 / 2 x T25 / 2 x T30 / 2 x T40	
	1 x Bit holder magnetic extra strong magnet 1/4"	

**31-pcs. in box, 1/4"**

7979-03

Order-No.	Icon	Quantity
36310		1
	2 x PZ1 / 3 x PZ2 / 1 x PZ3	
	2 x T10 / 6 x T15 / 6 x T20 / 6 x T25 / 2 x T30 / 2 x T40	
	1 x Bit holder magnetic extra strong magnet 1/4"	

**Bit Standard 25 mm**



**Slotted 1/4"**

7010 Z

Order-No.	Icon	mm	mm	mm	Icon	Quantity
01623		4,5	25	0,6		10
01624		5,5	25	0,8		10
01626		6,5	25	1,2		10
01627		8,0	25	1,6		10

**Phillips 1/4"**

7011 Z

Order-No.	Icon	mm	mm	Icon	Quantity
05298		PH0	25		10
01657		PH1	25		10
01658		PH2	25		10
01659		PH3	25		10
01649		PH4	32		10

**Pozidriv 1/4"**

7012 Z

Order-No.	Icon	mm	mm	Icon	Quantity
05300		PZ0	25		10
01688		PZ1	25		10
01689		PZ2	25		10
01690		PZ3	25		10
01681		PZ4	32		10



**TORX® 1/4"**

7015 Z



Order-No.	Icon	mm	mm	Icon	Quantity
26250		T3	25		10
25097		T4	25		10
01711		T5	25		10
01712		T6	25		10
01713		T7	25		10
01714		T8	25		10
01715		T9	25		10
01716		T10	25		10
01717		T15	25		10
01718		T20	25		10
01719		T25	25		10
01720		T27	25		10
01721		T30	25		10
01722		T40	25		10
01723		T45	35		10
01724		T50	35		10





**TORX® conical 1/4"**
**7015K Z**

Order-No.		mm	
04925	T10	25	10
04926	T15	25	10
04927	T20	25	10
04928	T25	25	10
04929	T27	25	10
04930	T30	25	10
04931	T40	25	10



**TORX PLUS® 1/4"**
**7016 Z**

Order-No.		mm	
25994	3IP	25	10
25996	4IP	25	10
25998	5IP	25	10
23173	6IP	25	10
23175	7IP	25	10
23177	8IP	25	10
23179	9IP	25	10
23181	10IP	25	10
23183	15IP	25	10
23185	20IP	25	10
23187	25IP	25	10
23189	27IP	25	10
23191	30IP	25	10
23193	40IP	25	10

**TORX® Tamper Resistant (with hole) 1/4"**
**7015 Z TR**

Order-No.		mm	
03115	T7H	25	10
03117	T8H	25	10
01726	T9H	25	10
01727	T10H	25	10
01728	T15H	25	10
01729	T20H	25	10
01730	T25H	25	10
01731	T27H	25	10
01732	T30H	25	10
01733	T40H	25	10



**TORX PLUS® Security, 1/4"**
**7016 Z IPR**

Order-No.		mm	
27530	8IPR	25	10
26346	10IPR	25	10
26347	15IPR	25	10
26348	20IPR	25	10
26349	25IPR	25	10
26350	30IPR	25	10
26351	40IPR	35	10

**MagicRing® hexagonal ball end, 1/4"**
**7017R Z**

Order-No.		mm	
22959	3,0	38	10
22960	4,0	38	10
22961	5,0	38	10
22962	6,0	38	10



**Hexagonal ball end 1/4"**
**7017 Z**

Order-No.		mm	
01734	1,5	38	10
01735	2,0	38	10
01736	2,5	38	10
01737	3,0	38	10
01738	4,0	38	10
01739	5,0	38	10
01740	6,0	38	10

**MagicRing® hex 1/4"**
**7013R Z**

Order-No.		mm	
22955	3,0	25	10
22956	4,0	25	10
22957	5,0	25	10
22958	6,0	25	10

**Hexagon 1/4"**
**7013 Z**

Order-No.		mm	
04011	1,5	25	10
01703	2,0	25	10
01704	2,5	25	10
01705	3,0	25	10
01706	4,0	25	10
01707	5,0	25	10
39875	5,5	25	10
01708	6,0	25	10
01709	8,0	25	10
01710	10,0	25	10

**Hexagon with hole 1/4"**
**7013 Z TR**

Order-No.		mm	
25560	TR2,0	25	10
25561	TR2,5	25	10
25562	TR3,0	25	10
25563	TR4,0	25	10
25564	TR5,0	25	10
26309	TR6,0	25	10
20558	TR5/64	25	10
20556	TR3/32	25	10
20559	TR7/64	25	10
20555	TR1/8	25	10
20560	TR9/64	25	10
20557	TR5/32	25	10
30050	TR3/16	25	10

### Internal square 1/4"

7018 Z

Order-No.	Icon	mm	mm	mm	Icon
06634	#1	2,3	25		5
06635	#2	2,8	25		5
06636	#3	3,3	25		5

### Spanner 1/4"

7019 Z SP

Order-No.	Icon	mm	mm	Icon
27064	4	25		10
27065	6	25		10
27066	8	25		10
27067	10	25		10

### Triple square 1/4"

7019 Z XZN

Order-No.	Icon	mm	mm	Icon
26352	M3	25		10
26353	M4	25		10
26354	M5	25		10
26355	M6	25		10
26356	M8	35		10

### SIT 1/4"

7019 Z SIT

Order-No.	Icon	mm	mm	Color	Icon
27256	SIT 10	25		pink	10
27257	SIT 20	25		orange	10
27258	SIT 25	25		green	10
27259	SIT 30	25		yellow	10
27260	SIT 40	25		light pink	10

### Torq-Set® 1/4"

7019 Z TS

Order-No.	Icon	mm	mm	Icon
27030	0	25		10
27028	1	25		10
26249	2	25		10
26045	3	25		10
22591	4	25		10
22592	5	25		10
22593	6	25		10
22594	8	25		10
22595	10	25		10
25572	1/4	32		10

### Tri-Wing® 1/4"

7019 Z TW

Order-No.	Icon	mm	mm	Icon
22603	0	25		10
22604	1	25		10
22605	2	25		10
22606	3	25		10
22607	4	25		10
22608	5	25		10

### Bit DryWall Stop Standard 25 mm



### Phillips 1/4"

7011 DWS

Order-No.	Icon	mm	mm	Icon
39382	PH2	25		10

### INFOBOX: TORX® tamper-resistant safety profile



- This safety profile is used to hinder unwanted access to equipment such as intercoms, thermostats and night-storage heaters.
- You can fasten the Torx® tamper resistant profile with both Torx® H screws and normal Torx® screws.

### INFOBOX: MagicRing®



#### Wiha MagicRing®

- Spring steel ring reliably holds hex screws in place
- An innovation, which will benefit each user.

### INFOBOX: Ball end hex



#### Wiha hexagonal ball end

- The ball end can be rotated by up to 25° in both clockwise and anti-clockwise direction.

**Bit set Standard 25 mm**



Order-No.		
32055	⊕ 10 x PH1	10
07855	⊕ 3 x PH1	10
36275	⊕ 20 x PH2	10
24733	⊕ 10 x PH2	10
07856	⊕ 3 x PH2	10
36280	⊕ 10 x PH3	10
07857	⊕ 3 x PH3	10
35709	⊕ 20 x PZ1	10
32070	⊕ 10 x PZ1	10
07859	⊕ 3 x PZ1	10
36282	⊕ 20 x PZ2	10
24742	⊕ 10 x PZ2	10
07860	⊕ 3 x PZ2	10
32071	⊕ 10 x PZ3	10
07861	⊕ 3 x PZ3	10
20542	⊕ 1 x PZ4	10
35832	⊕ 10 x T10	10
08421	⊕ 2 x T10	10
34746	⊕ 10 x T15	10
08422	⊕ 2 x T15	10
24746	⊕ 10 x T20	10
08423	⊕ 2 x T20	10
08424	⊕ 2 x T25	10
24748	⊕ 10 x T25	10
26451	⊕ 2 x T27	10
08425	⊕ 2 x T30	10
08426	⊕ 2 x T40	10
24750	⊕ 10 x T30	10
36288	⊕ 10 x T40	10
38649	⊕ 2 x T10H	10
38650	⊕ 2 x T15H	10
38651	⊕ 2 x T20H	10
38652	⊕ 2 x T25H	10
38653	⊕ 2 x T30H	10
38654	⊕ 2 x T40H	10
22655	● 1 x 4,01 x 5,01 x 6,0	10

Order-No.		
38656	● 2 x 3,0	10
25681	● 2 x 4,0	10
25679	● 2 x 5,0	10
38657	● 2 x 6,0	10
38658	■ 2 x #1 x 2,3	10
38659	■ 2 x #2 x 2,8	10
38660	■ 2 x #3 x 3,3	10

**Standard bit reduced diameter: 25 mm**



Order-No.		
35834	⊕ 10 x PH2	10
36285	⊕ 10 x PZ2	10

**Bit set DryWall Stop 25 mm**



Order-No.		
	●	7011 DWS
27077	⊕	1
	⊕	PH2 x 25



**Phillips (PH1), 50-pcs. in bulk pack, 1/4"**

7011Z

Order-No.	
08047	1
PH1 x 25	

**Phillips (PH2), 50-pcs. in bulk pack, 1/4"**

7011Z

Order-No.	
08048	1
PH2 x 25	

**Phillips (PH3), 50-pcs. in bulk pack, 1/4"**

7011Z

Order-No.	
08049	1
PH3 x 25	

**Pozidriv (PZ1), 50-pcs. in bulk pack, 1/4"**

7012Z

Order-No.	
08056	1
PZ1 x 25	

**Pozidriv (PZ2), 50-pcs. in bulk pack, 1/4"**

7012Z

Order-No.	
08057	1
PZ2 x 25	

**Pozidriv (PZ3), 50-pcs. in bulk pack, 1/4"**

7012Z

Order-No.	
08058	1
PZ3 x 25	

**TORX® (T10), 50-pcs. in bulk pack, 1/4"**

7015Z

Order-No.	
08065	1
T10 x 25	

**TORX® (T15), 50-pcs. in bulk pack, 1/4"**

7015Z

Order-No.	
08066	1
T15 x 25	

**TORX® (T20), 50-pcs. in bulk pack, 1/4"**

7015Z

Order-No.	
08067	1
T20 x 25	

**TORX® (T25), 50-pcs. in bulk pack, 1/4"**

7015Z

Order-No.	
08068	1
T25 x 25	

**TORX® (T27), 50-pcs. in bulk pack, 1/4"**

7015Z

Order-No.	
29544	1
T27 x 25	

**TORX® (T30), 50-pcs. in bulk pack, 1/4"**

7015Z

Order-No.	
08069	1
T30 x 25	

**TORX® (T40), 50-pcs. in bulk pack, 1/4"**

7015Z

Order-No.	
08070	1
T40 x 25	



Bit set Standard 25 mm



Phillips (PH2), 100-pcs. in bulk pack, 1/4"

7930 Z

Order-No.	
40461	1
PH2 x 25	

Pozidriv (PZ2), 100-pcs. in bulk pack, 1/4"

7930 Z

Order-No.	
40462	1
PZ2 x 25	

TORX® (T20), 100-pcs. in bulk pack, 1/4"

7930 Z

Order-No.	
40463	1
T20 x 25	

TORX® (T25), 100-pcs. in bulk pack, 1/4"

7930 Z

Order-No.	
40464	1
T25 x 25	

TORX® (T30), 100-pcs. in bulk pack, 1/4"

7930 Z

Order-No.	
40465	1
T30 x 25	

Bit Professional



Slotted 1/4"

7040 Z

Order-No.		mm		
33961	2,5	70	0,4	5
01790	3,0	50	0,5	5
33962	3,0	70	0,5	5
01792	3,5	50	0,6	5
33963	3,5	70	0,6	5
01791	4,0	50	0,5	5
01794	4,0	50	0,8	5
33964	4,0	70	0,8	5
01793	4,5	50	0,6	5
01795	5,5	50	0,8	5
01796	5,5	50	1,0	5
33965	5,5	70	1,0	5
01798	6,5	50	1,2	5
33966	6,5	70	1,2	5
01799	8,0	50	1,2	5
01800	8,0	50	1,6	5

Phillips 1/4"

7041 Z

Order-No.		mm	
31960	PH00	50	5
31961	PH00	70	5
31962	PH00	90	5
32105	PH0	50	5
35456	PH0	70	5
35457	PH0	90	5
33703	PH1	50	5
01803	PH1	70	5
04126	PH1	90	5
23213	PH1	110	5
23219	PH1	127	5
22509	PH1	150	5
33704	PH2	50	5
01805	PH2	70	5
04009	PH2	90	5
05800	PH2	110	5
06888	PH2	127	5
22510	PH2	150	5
33705	PH3	50	5
04010	PH3	70	5
04127	PH3	90	5
23215	PH3	110	5
23217	PH3	127	5
22511	PH3	150	5

**⊕ Pozidriv 1/4"**

7042 Z

Order-No.	⊕	mm	
31957	PZ0	50	5
31958	PZ0	70	5
31959	PZ0	90	5
33706	PZ1	50	5
01808	PZ1	70	5
01809	PZ1	90	5
23221	PZ1	110	5
23225	PZ1	127	5
23227	PZ1	150	5
33707	PZ2	50	5
01811	PZ2	70	5
01812	PZ2	90	5
05799	PZ2	110	5
06889	PZ2	127	5
23228	PZ2	150	5
33708	PZ3	50	5
04059	PZ3	70	5
04176	PZ3	90	5
23223	PZ3	110	5
23226	PZ3	127	5
22512	PZ3	150	5

**⊕ PlusMinus/Phillips 1/4"**

7049PHM

Order-No.	⊕	mm	
32490	SL/PH1	50	5
32491	SL/PH1	70	5
32686	SL/PH1	90	5
32492	SL/PH2	50	5
32493	SL/PH2	70	5
32687	SL/PH2	90	5

**⊕ PlusMinus/Pozidriv 1/4"**

7049PZM

Order-No.	⊕	mm	
32494	SL/PZ1	50	5
32495	SL/PZ1	70	5
32688	SL/PZ1	90	5
32496	SL/PZ2	50	5
32497	SL/PZ2	70	5
32689	SL/PZ2	90	5

**⊕ TORX® ball end 1/4"**

7045BE

Order-No.	⊕	mm	
32409	T9	50	5
32410	T10	50	5
32416	T10	70	5
32417	T15	50	5
32418	T15	70	5
32411	T20	50	5
32419	T20	70	5
32412	T25	50	5
32421	T25	70	5
32413	T27	50	5
32414	T30	50	5
32423	T30	70	5
32415	T40	50	5

**⊕ TORX® MagicSpring® 1/4"**

7045R



Order-No.	⊕	mm	
34452	T10	50	5
34453	T15	50	5
34454	T20	50	5
34455	T25	50	5
34456	T30	50	5
34457	T40	50	5

**⊕ TORX® 1/4"**



7045 Z

Order-No.	⊕	mm	
39184	T1	50	5
39185	T2	50	5
39186	T3	50	5
39187	T4	50	5
32299	T5	50	5
32302	T6	50	5
33709	T6	70	5
33717	T6	90	5
38370	T6	150	5
32303	T7	50	5
33710	T7	70	5
33718	T7	90	5
38371	T7	150	5
32304	T8	50	5
33711	T8	70	5
33719	T8	90	5
36327	T8	150	5
32305	T9	50	5
33712	T9	70	5
33720	T9	90	5
38372	T9	150	5
32306	T10	50	5
33713	T10	70	5
33721	T10	90	5





Order-No.		mm	
33725	T10	110	5
33726	T10	150	5
32307	T15	50	5
33714	T15	70	5
33722	T15	90	5
33727	T15	110	5
33728	T15	150	5
32308	T20	50	5
33715	T20	70	5
33723	T20	90	5
33729	T20	110	5
33730	T20	150	5
32309	T25	50	5
33716	T25	70	5
33724	T25	90	5
33731	T25	110	5
33732	T25	150	5
33920	T27	50	5
33921	T27	70	5
33922	T27	90	5
33923	T30	50	5
33924	T30	70	5
33925	T30	90	5
33926	T30	110	5
33927	T30	150	5
33928	T40	50	5
33929	T40	70	5
33930	T40	90	5
33931	T40	110	5
33932	T40	150	5

**TORX® Tamper Resistant (with hole) 1/4"** 7045 Z TR

Order-No.		mm	
21045	T7H	50	5
21047	T8H	50	5
20218	T9H	50	5
20219	T10H	50	5
39188	T10H	90	5
24867	T15H	50	5
39189	T15H	90	5
20220	T20H	50	5
39190	T20H	90	5
20221	T25H	50	5
39191	T25H	90	5
20222	T27H	50	5
39192	T27H	90	5
20223	T30H	50	5
39193	T30H	90	5
20224	T40H	50	5
39194	T40H	90	5

**TORX PLUS® 1/4"**

7046 Z

Order-No.		mm	
39195	1IP	50	5
39196	2IP	50	5
32486	3IP	50	5
39197	4IP	50	5
39198	4IP	90	5
28481	5IP	50	5
39199	5IP	90	5
31973	6IP	90	5
26000	6IP	50	5
26002	7IP	50	5
23195	8IP	50	5
31975	8IP	90	2
23197	9IP	50	5
23199	10IP	50	5
31977	10IP	90	5
23201	15IP	50	5
25553	15IP	90	5
23203	20IP	50	5
39200	20IP	90	5
23205	25IP	50	5
39201	25IP	90	5
23207	27IP	50	5
39202	27IP	90	5
23209	30IP	50	5
39203	30IP	90	5
23211	40IP	50	5
39204	40IP	90	5

**Torq-Set® 1/4"**

7049 TS

Order-No.		mm	
22596	4	50	5
22597	5	50	5
22598	6	50	5
22599	8	50	5
22600	10	50	5

**Hexagonal ball end 1/4"**

7047R Z

Order-No.		mm	
25739	3,0	50	5
25740	4,0	50	5
25741	5,0	50	5
25742	6,0	50	5

**MagicRing® hex 1/4"**

7043R Z

Order-No.		mm	
23145	3,0	50	5
23147	4,0	50	5
23149	5,0	50	5
23151	6,0	50	5



## Hexagon 1/4"

7043 Z

Order-No.	mm	mm	
05301	1,5	50	5
05302	2,0	50	5
34554	2,0	70	5
39178	2,0	90	5
05303	2,5	50	5
34555	2,5	70	5
39179	2,5	90	5
04194	3,0	50	5
34556	3,0	70	5
39180	3,0	90	5
04195	4,0	50	5
34557	4,0	70	5
39181	4,0	90	5
04196	5,0	50	5
34558	5,0	70	5
39182	5,0	90	5
04197	6,0	50	5
34559	6,0	70	5
39183	6,0	90	5
04198	8,0	50	5
34560	8,0	70	5

## Square 1/4"

7048 Z

Order-No.		mm	mm	
06637	#1	2,3	50	5
39206	#1	2,3	90	5
06638	#2	2,8	50	5
39207	#2	2,8	90	5
06639	#3	3,3	50	5
39208	#3	3,3	90	5

## Bit Professional



### Bit Professional 70 mm

Order-No.		
38706	2 x PH1	10
38707	2 x PH2	10

### Bit Professional 50 mm

Order-No.		
38676	2 x PH1	10
36193	2 x PH2	10
38677	2 x PH3	10
38679	2 x PZ1	10
38680	2 x PZ2	10
38681	2 x PZ3	10
32805	1 x T20	10
38684	2 x T10	10
38685	2 x T15	10
38686	2 x T20	10
38687	2 x T25	10
38688	2 x T27	10
38689	2 x T30	10
38690	2 x T40	10

### Bit Professional 70 mm

Order-No.		
38708	2 x PH3	10
38709	2 x PZ1	10
38710	2 x PZ2	10
38711	2 x PZ3	10
36086	2 x SL/PZ1	10
36082	2 x SL/PZ2	10
32806	1 x T25	10
38712	2 x T10	10
38713	2 x T15	10
32808	1 x T20	10
38714	2 x T20	10
38715	2 x T25	10
38716	2 x T27	10
38717	2 x T30	10
38718	2 x T40	10

## Bit set Professional 70 mm



### TORX® ball end 1/4" in bit band 10-pcs.

7045BE 9570

Order-No.	
32804	1
	2 x T10 / 2 x T15 / 2 x T20 / 2 x T25 / 2 x T30

## Micro-bit set ESD



### Mixed 65-pcs. in box

7000 SK65 ESD

Order-No.	
39971	1
	1 x 0,8 / 1 x 1,2 / 1 x 1,5 / 1 x 1,8 / 1 x 2,0 / 1 x 2,5 / 1 x 3,0 / 1 x 3,5 / 1 x 4,0
	1 x 0,7 / 1 x 0,9 / 2 x 1,3 / (0,050") / 1 x 1,5 / 1 x 2,0 / 1 x 2,5 / 1 x 3,0 / 2 x 4,0 / (5/32") / 1 x 3/32 / 1 x 1/16 / 1 x 5/64 / 1 x 7/64 / 1 x 1/8 / 1 x 9/64
	1 x T3 / 1 x T4 / 1 x T5 / 1 x T6 / 1 x T7 / 1 x T8 / 1 x T9 / 1 x T10 / 1 x T15 / 1 x T20
	1 x PL1 / 1 x PL2 / 1 x PL3 / 1 x PL4 / 1 x PL5 / 1 x PL6
	1 x PH000 / 1 x PH00 / 1 x PH0 / 1 x PH1
	1 x 5/64 / 1 x 3/32 / 1 x 7/64 / 1 x 1/8 / 1 x 9/64 / 1 x 5/32 / 1 x 3/16 / 1 x 7/32 / 1 x 2,0 / 1 x 2,5 / 1 x 3,0 / 1 x 3,5 / 1 x 4,0 / 1 x 4,5 / 1 x 5,0 / 1 x 5,5
	1 x Adapter 1/4" for micro-bits 4 mm drive /
	1 x Bit ratchet 90 mm with thumb wheel Hexagon head, 1/4" in blister pack
	Screwdriver handle, PicoFinish® ESD magnetic
	1 x Extension 100 mm for ESD screwdriver handle and micro-bits

## INFOBOX: TORX® ball end



### Wiha TORX® ball end

- With optimised TORX® ball end geometry
- Increased strength thanks to the special cold forming on a system developed by Wiha especially for this purpose.
- Allows fastening and unfastening at angles up to 25°.
- Simple insertion of the tool/bit and fastening/unfastening, especially in hard-to-reach positions.
- Broad product range: As an L-key, as a bit and as a SoftFinish® screwdriver.



⊖ Slotted drive 4 mm

7000 4 Z

Order-No.	⊖	mm	⊖	
40600	0,8	28	0,20	10
40601	1,2	28	0,25	10
40602	1,5	28	0,25	10
40603	1,8	28	0,30	10
40604	2,0	28	0,40	10
40605	2,5	28	0,40	10
40606	3,0	28	0,50	10
40607	3,5	28	0,60	10
40608	4,0	28	0,80	10

⊕ Phillips drive 4 mm

7001 4 Z

Order-No.	⊕	mm	
40609	PH000	28	10
40610	PH00	28	10
40611	PH0	28	10
40612	PH1	28	10
40613	PH2	28	10

● Hexagon drive 4 mm

7003 4 Z

Order-No.	●	mm	
40614	0,7	28	10
40615	0,9	28	10
40616	1,3 / (0,050")	28	10
40617	1,5	28	10
40618	2,0	28	10
40619	2,5	28	10
40620	3,0	28	10
40621	4,0 / (5/32")	28	10
40622	1/16	28	10
40623	5/64	28	10
40624	3/32	28	10
40625	7/64	28	10
40626	1/8	28	10
40627	9/64	28	10

⊗ TORX® drive 4 mm

7005 4 Z

Order-No.	⊗	mm	
40628	T1	28	10
40629	T2	28	10
40630	T3	28	10
40631	T4	28	10
40632	T5	28	10
40633	T6	28	10
40634	T7	28	10
40635	T8	28	10
40636	T9	28	10
40637	T10	28	10
40638	T15	28	10
40639	T20	28	10

⊙ Pentalobe drive 4 mm

7009 4 Z

Order-No.	⊙	mm	
40640	PL1	28	10
40641	PL2	28	10
40642	PL3	28	10
40643	PL4	28	10
40644	PL5	28	10
40645	PL6	28	10

INFOBOX:  
Pentalobe



The security profile for Apple devices.

- Ideal for repairing Apple smartphones, tablets and notebooks.
- Note: The guarantee and warranty conditions of the device manufacturer must be observed.

### Micro nut driver 30 mm



#### Hexagon socket drive 4 mm

7044 4 Z

Order-No.	⊙	⦿	mm	📦
40654	2,0	30	10	
40655	2,5	30	10	
40656	3,0	30	10	
40657	3,5	30	10	
40658	4,0	30	10	
40659	4,5	30	10	
40660	5,0	30	10	
40661	5,5	30	10	
40646	5/64	30	10	
40647	3/32	30	10	
40648	7/64	30	10	
40649	1/8	30	10	
40650	9/64	30	10	
40651	5/32	30	10	
40652	3/16	30	10	
40653	7/32	30	10	

### Extension 100 mm



#### for ESD screwdriver handle and micro-bits

7103

Order-No.	⊙	⦿	mm	📦
40663	4	4	100	10

### Adapter 1/4"



#### for micro-bits 4 mm drive

7103

Order-No.	⦿	⊙	📦
39964	4	1/4	10

### Bit holder magnetic



#### for micro-bits 4 mm drive

7110

Order-No.	⊙	⦿	mm	📦
32505	4	1/4	60	10

### Bit with thread



#### Phillips M4

7311 Z

Order-No.	⊕	mm	⦿	+	-	📦
01937	PH1	33	5,5	M4	8,00	10
01938	PH2	33	6,0	M4	8,00	10

#### Pozidriv M4

7312 Z

Order-No.	⊕	mm	⦿	+	-	📦
01939	PZ1	33	5,5	M4	8,00	10
01940	PZ2	33	6,0	M4	8,00	10

#### Phillips M5

7321 Z

Order-No.	⊕	mm	⦿	+	-	📦
01942	PH2	33	7,0	M5	8,00	10
01943	PH2	45	6,0	M5	8,00	10

#### Pozidriv M5

7322 Z

Order-No.	⊕	mm	⦿	+	-	📦
01945	PZ2	33	7,0	M5	8,00	10
01946	PZ2	45	6,0	M5	8,00	10

#### TORX® M5

7325 Z

Order-No.	⊕	mm	⦿	+	-	📦
35400	T10	45	6,0	M5	8,00	10
35401	T15	45	6,0	M5	8,00	10
35402	T20	45	6,0	M5	8,00	10
35403	T25	45	6,0	M5	8,00	10

#### Phillips M6

7331 Z

Order-No.	⊕	mm	⦿	+	-	📦
04678	PH2	33	8,0	M6	8,00	10
04677	PH2	45	8,0	M6	8,00	10

**⊕ Pozidriv M6**

7332 Z

Order-No.	⊕	mm	●	+	→	📦
04671	PZ2	33	8,0	M6	8,00	10
04670	PZ2	45	8,0	M6	8,00	10

**⊕ Phillips UNF 10/32"**

7341 Z

Order-No.	⊕	mm	●	+	→	📦
01947	PH2	45	6,0	10/32 UNF	8,00	10

**⊕ Pozidriv UNF 10/32"**

7342 Z

Order-No.	⊕	mm	●	+	→	📦
01948	PZ2	45	6,0	10/32 UNF	8,00	10

**Combination drill bit set**



**1/4" 5-pcs.**

79187 B5

Order-No.	📦
28026	1
⊙	M3 x 36 / M4 x 39 / M5 x 41 / M6 x 44 / M8 x 51

**Combination drill bit**



**⊙ 1/4"**

7807

Order-No.	⊙	mm	●	📦
27897	M3	36	1/4	10
27898	M4	39	1/4	10
27899	M5	41	1/4	10
27900	M6	44	1/4	10
27901	M8	51	1/4	10
27963	M10	65	1/4	10

**Countersink bit set**



**1/4" 5-pcs.**

79186 B5

Order-No.	📦
28027	1
⊙	6,3 x 35 / 8,3 x 35 / 10,4 x 35 / 12,4 x 35 / 16,5 x 35

**Countersink bit**



**⊙ 1/4"**

7806

Order-No.	⊙	mm	●		Ø min.	📦
27892	6,3	35	1/4	M3	1,5	10
27893	8,3	35	1/4	M4	2,0	10
27894	10,4	35	1/4	M5	2,5	10
27895	12,4	35	1/4	M6	2,8	10
27896	16,5	35	1/4	M8	3,2	10
28058	20,5	35	1/4	M10	3,5	10

### Nut driver insert



#### Hexagon head 1/4"

7044

Order-No.	⌀	mm	Icon
04514	5,0	55	5
04513	5,5	55	5
04512	6,0	55	5
04511	7,0	55	5
04510	8,0	55	5
04509	10,0	55	5
04508	13,0	55	5
04515	1/4	55	5
04516	5/16	55	5
04517	3/8	55	5

### Nut driver insert, magnetic



#### Hexagon head 1/4"

7044 M

Order-No.	⌀	mm	Icon
04637	5,0	55	5
04636	5,5	55	5
04635	6,0	55	5
04634	7,0	55	5
04633	8,0	55	5
04632	10,0	55	5
04631	13,0	55	5
04638	1/4	55	5
04639	5/16	55	5
04640	3/8	55	5

### Tool shaft



#### Square, Internal hexagon C6,3

7210

Order-No.	Icon 1	Icon 2	Icon 3	Icon 4
01933	1/4	1/4	25	5
04204	3/8	1/4	30	5

### Tool shaft



#### Square, Internal hexagon C6,3

7240

Order-No.	Icon 1	Icon 2	Icon 3	Icon 4	Icon 5
04685	1/4	1/4	100	B	5
01935	1/4	1/4	50		5
04684	3/8	1/4	100		5
04362	3/8	1/4	50		5

Adapter DIN 7428.

### Connector with retaining ring



#### Hexagon head, Square head form G 6.3 + G 10 + G 12.5

7201

Order-No.	Icon 1	Icon 2	Icon 3	Icon 4	Icon 5
01924	1/4"	1/4"	25	D 6,3	2
01926	1/4"	3/8"	30	D 6,3	2
01922	1/4"	1/2"	35	D 6,3	2
01927	5/16"	3/8"	30	D 8	2
01923	5/16"	1/2"	35	D 8	2

### Connector with quick release holder



#### Hexagon head, Square head form G 12.5

7203

Order-No.	Icon 1	Icon 2	Icon 3	Icon 4
01930	1/4	1/2	50	2

Hand impact screwdriver set



Mixed, 6-pcs. in box, 1/2"

24636

Order-No.				
32573				1
	Hand impact screwdriver Internal square 1/2"			
	9 x 1,6 / 11 x 1,6			
	PH2 x 5/16 / PH3 x 5/16			
	Heavy-duty bit holder clamping with ball Hexagon head, internal square form C 8 (5/16"), 1/2"			

Hand impact screwdriver



Internal square 1/2"

24636

Order-No.					
32556	1/2	163			1

Heavy-duty bit holder clamping with ball



Hexagon head, internal square form C 8 (5/16"), 1/2"

7204Z-516

Order-No.						
32547	5/16	1/2	38			5

Bit holder CentroFix Force mechanically lockable



○ 1/4", magnetic

7148 CF

Order-No.	○	●	mm	📦
39133	1/4	1/4	60	1

Bit holder CentroFix mechanically lockable



○ 1/4"

7148C

Order-No.	○	●	mm	📦
32477	1/4	1/4	60	10

Bit holder CentroFix Super Slim mechanically lockable



○ 1/4", magnetic

7148 CS

Order-No.	○	●	mm	📦
39134	1/4	1/4	66	1

Bit holder MagicFlip Force magnetic



○ with ring magnet, 1/4"

7123

Order-No.	○	●	mm	📦
36800	1/4	1/4	62	10

INFOBOX:  
Drive systems and matching bits



Bit holder	suitable for
CentroFix Force	C 6.3, E 6.3 und 1/4" drives
CentroFix SuperSlim	C 6.3
MagicFlip Force	C 6,3

INFOBOX:  
CentroFix Force



CentroFix Force

- Suitable for all bits with 1/4" hex drive style C6.3 and E6.3.
- SelfLock: The bit is locked mechanically and held securely when inserted.
- EasyOut: When unlocked, the bit moves into the ideal removal position.

INFOBOX:  
CentroFix SuperSlim



- Up to 30% reduced outer diameter compared to "conventional" quick release holders.
- Improved screw accessibility in confined holes.
- SelfLock: The bit is locked mechanically and held securely when inserted.
- EasyOut: When unlocked, the bit moves into the ideal removal position.



**Bit holder magnetic, clamping with retaining ring**



Ø 1/4"

7143

Order-No.	Ø	mm	mm	
01913	1/4	1/4	72	2
36092	1/4	1/4	100	5
34306	1/4	1/4	150	5
36093	1/4	1/4	200	5
36094	1/4	1/4	250	5

**Bit holder clamping with retaining ring**



Ø 1/4"

7140

Order-No.	Ø	mm	mm	
01910	1/4	1/4	57	5

**Bit holder magnetic, 74 mm**



Ø 1/4"

7113

Order-No.	Ø	mm	mm	
01894	1/4	1/4	74	10

**Bit holder magnetic**



Ø extra strong magnet, 1/4"

7113 P

Order-No.	Ø	mm	mm	
41922	1/4	1/4	60	10

**Bit holder magnetic, 58 mm**



Ø 1/4"

7113 S

Order-No.	Ø	mm	mm	
01895	1/4	1/4	58	10

Ø 1/4" in blister pack

7113 S

Order-No.	Ø	mm	mm	
07869	1/4	1/4	58	10

**Universal holder, magnetic/ retaining ring, style G 7.**



Ø

7183

Order-No.	Ø	mm	mm	
01919	1/4	G7	72	2

**Industrial bit holder, with magnet, Halfmoon 4 mm.**



Ø

7110H

Order-No.	Ø	mm	mm	
36112	4	50		1

**INFOBOX: MagicFlip Force**



- Facilitates the fastening of long wood screws.
- Optimal holding force thanks to extremely powerful Neodym ring magnet.
- FlipBack: The actuating sleeve automatically springs back during recessing.
- Magnet On/Off: The ring magnet can be "deactivated" by pushing the actuating sleeve back.

Screwdriver with bit holder SoftFinish® magnetic



Ø 1/4"

384

Order-No.	Ø	mm	mm	mm	mm	mm
01475	1/4	125	225	36	10	
01476	1/4	300	400	36	5	

Screwdriver with bit holder SoftFinish® clamping with retaining ring



Ø flexible shaft, 1/4"

386

Order-No.	Ø	mm	mm	mm	mm	mm
01479	1/4	150	268	36	10	

Screwdriver with bitholder, Quick-release holder



Ø 1/4"

387 01

Order-No.	Ø	mm	mm	mm	mm	mm
25874	1/4	35	146	30	10	

Screwdriver with SoftFinish® CentroFix bit holder, mechanically lockable



Ø 1/4"

387 02

Order-No.	Ø	mm	mm	mm	mm	mm
40331	1/4	38	149	36	10	

Screwdriver with bit holder SoftFinish® magnetic



Ø 1/4"

281 02

Order-No.	Ø	mm	mm	mm	mm	mm
32160	1/4	125	36		10	

Screwdriver with bit holder magnetic



○ Stubby, 1/4"

281 01

Order-No.	○	⇄	+	📦
29463	1/4	57	34	10

Screwdriver with bit holder ESD



○ Stubby, 1/4"

281-01ESD

Order-No.	○	⇄	+	📦
32484	1/4	57	34	10

Handle: IEC 61340-5-1.

Screwdriver with bit holder SoftFinish® ESD, mechanically lockable



○ 1/4"

387ESD

Order-No.	○	⇄	mm	+	📦
32161	1/4	38	148	30	5

Handle: IEC 61340-5-1.

Screwdriver handle, PicoFinish® ESD magnetic



○ For 4 mm MicroBits

281P

Order-No.	○	mm	📦
43709	4	96	

Screwdriver with T-handle and bit holder magnetic



○ 1/4"

388

Order-No.	○	⇄	+	📦
01481	1/4	150	80	10

Screwdriver with T-handle and two bit holders ComfortGrip magnetic



○ 1/4"

388DS

Order-No.	○	⇄	+	📦
26179	1/4	150	100	10

High-performance offset screwdriver with quick release holder 1/4"



○ 1/4" in blister pack

24628

Order-No.	○	●	⇄	max. Nm	📦
32310	1/4	1/4	165	57	1

Offset screwdriver with bit holder 1/4", magnetic



○ 1/4" in blister pack

24629

Order-No.	○	●	⇄	max. Nm	📦
32311	1/4	1/4	130	14	1



## Pliers

**A cut above the rest for your health.**

Wiha pliers combine high-quality materials with ergonomic comfort. Precise interaction between the joints and the exact workmanship of the blades and gripping surfaces ensure optimum functionality. Ergonomically designed and crafted to a high quality standard, they are comfortable to use, causing less body fatigue and thus making work more efficient.

The “OptiGrip” triple-point support design for combination and high-leverage combination pliers ensure an optimum, secure hold when handled. The circlip pliers from the Classic Series with their MagicTips® precision tips made of high-performance steel provide added safety and stability. With its angled plier shape, the Wiha Inomic® VDE product line is kind to the user's joints, muscles and tendons. Wiha also supplies suitable tools for stripping, skinning and crimping.

## Application Pliers

### For applications in electrics



**Installation pliers TriCut Professional electric**  
Page 287



**BiCut® Professional electric high-performance diagonal cutters with DynamicJoint®**  
Page 288



**Heavy-duty diagonal cutters Professional electric with DynamicJoint®**  
Page 289



**Combination pliers Professional electric with DynamicJoint® and OptiGrip**  
Page 290



**Needle nose pliers Professional electric**  
Page 291



**Cable cutter Professional electric**  
Page 293



**Water pump pliers Professional electric, with push button adjustment**  
Page 293



**Hacksaw electric**  
Page 295



**Stripping tool automatic**  
Page 295



**Stripping tool**  
Page 296



**Automatic crimp tool, for wire-end sleeves hex crimping**  
Page 298



### For applications in mechanics



**Professional BiCut® high-performance diagonal cutters with DynamicJoint®, Switchable**  
Page 301



**Heavy-duty diagonal cutters Professional with DynamicJoint®**  
Page 303



**Combination pliers Professional with DynamicJoint® and OptiGrip**  
Page 304



**Needle-nose pliers Professional**  
Page 306



**Plastic diagonal cutters Classic, with opening spring without bevelled edge**  
Page 307



**Pliers wrench Classic**  
Page 308



**Water pump pliers QuickFix Professional automatic**  
Page 310



**Classic circlip pliers with MagicTips®, straight**  
Page 312



### For applications in electronics



**Pliers set Professional ESD**  
Page 316



**Needle nose pliers Professional ESD**  
Page 319



**Universal tweezers Professional ESD**  
Page 320



**Needle nose pliers Electronic**  
Page 323



Pliers set Professional electric



**Combination pliers, needle nose pliers, diagonal cutters 3-pcs.** Z 99 0 001 06

Order-No.  26852  1

**Trimming / cutting**

Professional electric diagonal cutters with DynamicJoint® 160 x 6 1/2" (43335)

**Supplying / holding**

- Combination pliers Professional electric with DynamicJoint® and OptiGrip with extra long cutting edge, VDE and GS tested / 180mm, 7" (26708)
- Needle nose pliers Professional electric with cutting edge straight shape, VDE and GS tested / 200mm, 8" (26727)

Manufactured acc. to IEC 60900.

Pliers set Industrial electric



**Combination pliers, needle nose pliers, diagonal cutters 3-pcs.** Z 99 0 001 09

Order-No.  38637  1

**Trimming / cutting**

Industrial electric diagonal cutters with DynamicJoint® 160 x 6 1/2" (43336)

**Supplying / holding**

- Industrial electric combination pliers with DynamicJoint® and OptiGrip with extra long cutting edge, VDE and GS tested / 180mm, 7" (33186)
- Industrial electric needle nose pliers with cutting edge straight shape, VDE and GS tested / 200mm, 8" (33178)

Manufactured acc. to IEC 60900.

INFOBOX:  
**Professional pliers  
Industrial pliers**



**Professional**

**Industrial**

- Professional: pliers, chrome-plated
- Industrial: pliers, polished/black oxidised

### Installation pliers TriCut Professional electric



Z 14 1 06

Order-No.	mm	mm	mm	Ømm	SB	Icon
38552	170	7	13	1.6		5
38853	170	7	13	1.6	x	5

Manufactured acc. to IEC 60900.

### Installation pliers TriCut Classic



Z 14 1 01

Order-No.	mm	mm	mm	Ømm	SB	Icon
38627	170	7	13	1.6		5
38854	170	7	13	1.6	x	5

## INFOBOX: VDE-certified tools



Wiha VDE-tested tools are subject to stringent safety test procedures.

All tools with the special marking have been tested at 10,000 V AC and are therefore approved for use at 1,000 V AC and 1,500 V DC.

The following equipment is required for all work on or around live components and should be appropriate for the specific task

- insulating personal protective equipment
- insulating safety mechanisms
- insulated tools

Before starting work, you must disconnect all active, live components of electrical machines and equipment and ensure that they remain disconnected while you carry out the work.

This is achieved by complying with the five safety rules:

- disconnect
- secure against reconnection
- ensure power is switched off
- earth and short-circuit
- cover or block off adjacent live components

Certified by the VDE Testing and Certification Institute and individually tested according to the international standard IEC 60900.



Stripping diagonal cutters Professional electric with DynamicJoint®



Z 14 0 06

Order-No.	mm	in	Scissors	Ømm	SB	Icon
26745	160	6 1/2"	13	1.6		5
27431	160	6 1/2"	13	1.6	x	5

DIN ISO 5749. Manufactured acc. to IEC 60900.

Professional electric diagonal cutters with DynamicJoint®



Z 12 1 06

Order-No.	mm	in	Scissors	Ømm	SB	Icon
43326	140	5 1/2"	16	1,6		5
43453	140	5 1/2"	16	1,6	x	5
43335	160	6 1/2"	17	2		5
43458	160	6 1/2"	17	2	x	5
43340	180	7"	18	2,3		5
43463	180	7"	18	2,8	x	5

Manufactured acc. to IEC 60900.

BiCut® Professional electric high-performance diagonal cutters with DynamicJoint®



reddot award 2014 winner

Z 18 0 06

**Switchable**

Order-No.	mm	in	Scissors	Ømm	SB	Icon
38191	200	8	21	3		5
38984	200	8	21	3	x	5

Manufactured acc. to IEC 60900.

Industrial electric diagonal cutters with DynamicJoint®



Z12109

Order-No.	mm	in	Scissors	Ømm	SB	Icon
43327	140	5 1/2"	16	1,6		5
43454	140	5 1/2"	16	1,6	x	5
43336	160	6 1/2"	17	2		5
43459	160	6 1/2"	17	2	x	5
43341	180	6"	18	2,8		5
43464	180	7"	18	2,8	x	5

Manufactured acc. to IEC 60900.



Heavy-duty diagonal cutters Professional electric with DynamicJoint®



with switchable opening spring

Z 16 3 06

Order-No.	mm	mm	mm	Ømm	SB	
40921	160	6,5	17	2		5
41309	160	6,5	17	2	x	5
41274	180	7	18	2,3		5
41319	180	7	18	2,3	x	5
41279	200	8	19	2,5		5
41329	200	8	19	2,5	x	5

DIN ISO 5749. Manufactured acc. to IEC 60900.

Industrial electric heavy-duty diagonal cutters with DynamicJoint®



with switchable opening spring

Z 16 3 09

Order-No.	mm	mm	mm	Ømm	SB	
40922	160	6,5	17	2		5
41310	160	6,5	17	2	x	5
41275	180	7	18	2,3		5
41320	180	7	18	2,3	x	5
41280	200	8	19	2,5		5
41330	200	8	19	2,5	x	5

DIN ISO 5749. Manufactured acc. to IEC 60900.

INFOBOX:  
DynamicJoint®



Wiha DynamicJoint® – A new dimension in strength and durability

- Innovative: Optimised joint construction.
- Effective: Minimal power loss means less force needed for cutting.
- Permanent: Optimal performance even after thousands of cuts.

INFOBOX:  
Heavy-duty diagonal cutters



with switchable opening spring

- Up to 40% more cutting force thanks to optimised leverage.
- Opening spring with on/off function for fatigue-free work.
- Opening spring can be activated with just one hand.



Combination pliers Professional electric with DynamicJoint® and OptiGrip



with extra long cutting edge

Z 01 0 06

Order-No.	mm	II	✂	Ømm	SB	🔌
26705	160	6 ½	15	1.6		5
27328	160	6 ½	15	1.6	x	5
26708	180	7	16	1.8		5
27418	180	7	16	1.8	x	5
26711	200	8	17	2		5
27419	200	8	17	2	x	5

DIN ISO 5746. Manufactured acc. to IEC 60900.

High-leverage combination pliers Professional electric with DynamicJoint® and OptiGrip



with extra long cutting edge

Z 02 0 06

Order-No.	mm	II	✂	Ømm	SB	🔌
26714	200	8	18	2.3		5
27420	200	8	18	2.3	x	5
26717	225	9	19	2.5		5
27421	225	9	19	2.5	x	5

DIN ISO 5746. Manufactured acc. to IEC 60900.

Industrial electric combination pliers with DynamicJoint® and OptiGrip



with extra long cutting edge

Z 01 0 09

Order-No.	mm	II	✂	Ømm	SB	🔌
33186	180	7	16	1.8		5
38855	180	7	16	1.8	x	5

DIN ISO 5746. Manufactured acc. to IEC 60900.

High-leverage industrial electric combination pliers with DynamicJoint® and OptiGrip



Z 02 0 09

Order-No.	mm	II	✂	Ømm	SB	🔌
35465	225	9	19	2.5		5
38856	225	9	19	2.5	x	5

DIN ISO 5746. Manufactured acc. to IEC 60900.

### Industrial lineman's pliers with DynamicJoint®



with extra long cutting edge

Z 02 2 02

Order-No.	mm	II	✂	Ømm	SB	📦
40927	250	10	20	2.5		5

### Classic lineman's pliers with DynamicJoint®



with extra long cutting edge

Z 02 2 01

Order-No.	mm	II	✂	Ømm	SB	📦
40709	250	10	20	2.5		5
41218	250	10	20	2.5	x	5

### Needle nose pliers Professional electric



with cutting edge straight shape

Z 05 0 06

Order-No.	mm	II	✂	Ømm	SB	📦
26720	160	6 1/2	16	1.2		5
27422	160	6 1/2	16	1.2	x	5
26727	200	8	17	1.6		5
27423	200	8	17	1.6	x	5

DIN ISO 5745. Manufactured acc. to IEC 60900.

### Industrial electric needle nose pliers



with cutting edge straight shape

Z 05 0 09

Order-No.	mm	II	✂	Ømm	SB	📦
35477	160	6 1/2	16	1.2		5
38857	160	6 1/2	16	1.2	x	5
33178	200	8	17	1.6		5
38858	200	8	17	1.6	x	1

DIN ISO 5745. Manufactured acc. to IEC 60900.

### INFOBOX: OptiGrip



Wiha OptiGrip – optimal grip due to newly designed gripping surfaces

- A firm hold: The „triple-point support“ protects the workpiece from twisting or slipping.
- Highly effective: Optimum grip even with large jaw opening – and at the same time significantly less force needed.
- A wide selection: Now in standard Wiha combination pliers and high leverage combination pliers.



### Needle nose pliers Professional electric



with cutting edge curved shape, approx. 40°

Z 05 1 06

Order-No.	mm	II	✂	Ømm	SB	📦
26728	160	6 ½	16	1.2		5
27424	160	6 ½	16	1.2	x	5
26729	200	8	17	1.6		5
27425	200	8	17	1.6	x	5

DIN ISO 5745. Manufactured acc. to IEC 60900.

### Long flat-nose pliers Professional electric



Z 07 0 06

Order-No.	mm	II	✂	SB	📦
26732	160	6 ½			5
27426	160	6 ½	x		5

DIN ISO 5745. Manufactured acc. to IEC 60900.

### Industrial electric needle nose pliers



with cutting edge curved shape, approx. 40°

Z 05 1 09

Order-No.	mm	II	✂	Ømm	SB	📦
35462	200	8	17	1.6		5
38859	200	8	17	1.6	x	5

DIN ISO 5745. Manufactured acc. to IEC 60900.

### Long round-nose pliers Professional electric



Z 09 0 06

Order-No.	mm	II	✂	SB	📦
26735	160	6 ½			5
27427	160	6 ½	x		5

DIN ISO 5745. Manufactured acc. to IEC 60900.

### Cable cutter Professional electric



Z 50 1 06

Order-No.	mm	II	✂	mm <sup>2</sup>	SB	📦
34743	160	6 ½	16	50		5
35704	160	6 ½	16	50	x	5
34744	200	8	20	60		5
35705	200	8	20	60	x	5

Manufactured acc. to IEC 60900.

### Industrial electric cable cutter



Z 50 1 09

Order-No.	mm	II	✂	mm <sup>2</sup>	SB	📦
38636	160	6 ½	16	50		5
38865	160	6 ½	16	50	x	5
35479	200	8	20	60		5
38866	200	8	20	60	x	5

Manufactured acc. to IEC 60900.

### Cable cutter Classic



Z 50 1 01

Order-No.	mm	II	✂	mm <sup>2</sup>	SB	📦
34729	160	6 ½	16	50		5
36217	160	6 ½	16	50	x	5
34730	200	8	20	60		5
36981	200	8	20	60	x	5

### Water pump pliers Professional electric



box type

Z 21 0 06

Order-No.	mm	II	○	⊗	SB	📦
33520	250	10	2	50		5
38631	250	10	2	50	x	5

DIN ISO 8976. Manufactured acc. to IEC 60900.

### Water pump pliers Professional electric



with push button adjustment

Z 22 0 06

Order-No.	mm	II	○	⊗	SB	📦
37450	250	10	2	50		5
38632	250	10	2	50	x	5

DIN ISO 8976. Manufactured acc. to IEC 60900.

### Stripping pliers Professional electric



Z 55 0 06

Order-No.	mm	II	Ø	mm <sup>2</sup>	SB	Icon
26847	160	6 1/2	5	10		5
27437	160	6 1/2	5	10	x	5

DIN ISO 5743. Manufactured acc. to IEC 60900.

### Stripping pliers Industrial



Z 55 0 02

Order-No.	mm	II	Ø	mm <sup>2</sup>	SB	Icon
32345	160	6 1/2	5	10		5
34313	160	6 1/2	5	10	x	5

DIN ISO 5743.

### Industrial electric stripping pliers



Z 55 0 09

Order-No.	mm	II	Ø	mm <sup>2</sup>	SB	Icon
36711	160	6 1/2	5	10		5
38867	160	6 1/2	5	10	x	5

DIN ISO 5743. Manufactured acc. to IEC 60900.

### Stripping pliers Classic



Z 55 0 01

Order-No.	mm	II	Ø	mm <sup>2</sup>	SB	Icon
26845	160	6 1/2	5	10		5
27368	160	6 1/2	5	10	x	5

DIN ISO 5743.

### Stripping pliers Professional



Z 55 0 05

Order-No.	mm	II	Ø	mm <sup>2</sup>	SB	Icon
26846	160	6 1/2	5	10		5

DIN ISO 5743.

Stripping tool automatic



up to 16 mm<sup>2</sup> in blister pack

Z 57 0 06

Order-No.	mm	II	mm <sup>2</sup>	AWG	SB	📦
42062	200	8	0,03 - 16	32-5	x	1

Stripping tool automatic



up to 6 mm<sup>2</sup> in blister pack

24675

Order-No.	mm	II	mm <sup>2</sup>	AWG	SB	📦
36050	190	7 1/2	0,2-6,0	24-10	x	1

Spare blade and gripping jaw set

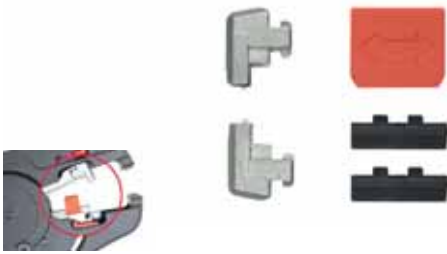

for automatic stripping tool

Z 57 0 001 06K

Order-No.	📦
42162	1

Hacksaw electric



insulated with three saw blades 150 mm

246176

Order-No.	🔪	mm	SB	📦
43125	150	280	x	1

INFOBOX:  
Stripping tool,  
automatic up to  
16mm<sup>2</sup>



- These pliers can handle a wide range of cables, thus combining two pairs of pliers in one.
- The supplied damper can be used to lessen recoil caused by larger cable gauges, such as those greater than 6 mm<sup>2</sup>, thus helping to protect wrists.
- Precise cutting to length thanks to adjustable longitudinal stop.
- Integrated hand protection along the cutting edge guards against injury.



Stripping tool



with self-rotating trailing blade

24622

Order-No.	mm	II	Ømm	SB	
35969	165	6½	4,0-28		1
35538	165	6½	4,0-28	x	1

Cable stripping knife



straight cutting edge for round cables in blister pack

24680

Order-No.	mm	II	SB	
38798	200	8	x	1

Manufactured acc. to IEC 60900.

Cable stripping knife



hooked blade with sliding shoe for round cable, in blister pack

24678

Order-No.	mm	II	SB	
36053	200	8	x	1

Manufactured acc. to IEC 60900.

Stripping tool



for coaxial cable, in blister pack

24676

Order-No.	mm	II	mm²	SB	
36051	110	4¼	4,8-7,5	x	1

Stripping tool



for round cable, in blister pack

24677

Order-No.	mm	II	mm²	SB	
36052	125	5	8-13	x	1



Crimping pliers Classic



Z 60 0 01



Order-No.	mm	II	mm <sup>2</sup>	
28330	145	5 ¼	0,25-2,5	5

DIN ISO 5743.

Crimping pliers Professional electric



Z 60 0 06

Order-No.	mm	II	mm <sup>2</sup>		
35861	145	5 ¼	0,25-2,5		5
38985	145	5 ¼	0,25-2,5	x	5

DIN ISO 5743. Manufactured acc. to IEC 60900.

Crimping pliers Classic



Z 60 0 01



Order-No.	mm	II	mm <sup>2</sup>	
30066	180	7	0,25-16	5

DIN ISO 5743.

Crimping pliers Professional electric



Z 60 0 06

Order-No.	mm	II	mm <sup>2</sup>		
35862	180	7	0,25-16		5
38986	180	7	0,25-16	x	5

DIN ISO 5743. Manufactured acc. to IEC 60900.



## Automatic crimp tool



for wire-end sleeves hex crimping

Z 62 0 06

Order-No.	mm	mm <sup>2</sup>	AWG	
41246	210	0,08-16	28-5	1



For processing twin sleeves and wire-end sleeves with or without insulating collar as per DIN 46228 & EN 50027

## Crimp tool



for wire-end sleeves

Z 62 0 06

Order-No.	mm	mm <sup>2</sup>	AWG		
33844	220	0,14-16	26-5		1
40342	220	0,14-16	26-5	x	1

For processing of wire-end sleeves with and without isolating collar according to DIN 46228, EN 50027.

## Crimp tool



for insulated cable eyes and contacts

Z 62 0 06

Order-No.	mm	mm <sup>2</sup>	AWG	
33841	220	0,5-6	20-10	1

For processing of red, blue and yellow isolated cable eyes, pin-end cable connectors, contact pins, contact pin sleeves, circular pins, circular pin sleeves, batch connectors and parallel connectors according to DIN 46234.

## INFOBOX: Automatic crimp tool



- Process-safe hexagonal crimping prevents smaller wire-end sleeves from snagging.
- These crimping pliers can handle all standard applications with a crimping range between 0.08 and 16 mm<sup>2</sup>.
- Suitable for both single wire-end sleeves and twin wire-end sleeves thanks to automatic crimping.

### Crimp tool



for non-insulated cable eye with closed sleeve

Z 62 0 06

Order-No.	mm	mm <sup>2</sup>	AWG	
33843	220	0,1-16	26-6	1

For processing of non-isolated contact pins and contact pin sleeves according to DIN 46247 for standardised, solderless electrical connections.

### Shear for electricians



with crimp function in blister pack

Z 71 7 06

Order-No.	mm	mm <sup>2</sup>	
41923	160	50	5

### Crimp tool



for non-insulated male blade connectors

Z 62 0 06

Order-No.	mm	mm <sup>2</sup>	AWG	
33842	220	0,25-6	24-10	1

For processing of non-isolated contact pins and contact pin sleeves according to DIN 46247 for standardised, solderless electrical connections.

### Craftsman's cutters



Standard model made of stainless steel

Z 71 5 06

Order-No.	mm	mm	
29420	145	5 3/4	5



Pliers set Classic



High-leverage combination pliers, water pump pliers, heavy-duty diagonal cutters, 3-pcs.

Z 99 0 002 01

Order-No.	
26853	1
	High-leverage combination pliers Classic with DynamicJoint® and OptiGrip with extra long cutting edge 200mm, 8" (26712)
	Heavy-duty diagonal cutters Classic with DynamicJoint® 180mm, 7" (41261)
	Water pump pliers QuickFix Classic automatic 250mm, 10" (39091)

Pliers set Professional



High-leverage combination pliers, water pump pliers, heavy-duty diagonal cutters, 3-pcs.

Z 99 0 002 05

Order-No.	
26854	1
	High-leverage combination pliers Professional with DynamicJoint® and OptiGrip with extra long cutting edge 200mm, 8" (26713)
	Heavy-duty diagonal cutters Professional with DynamicJoint® with switchable opening spring 180mm, 7" (41273)
	Water pump pliers QuickFix Professional automatic automatic 250mm, 10" (39093)

Pliers set Classic



Combination pliers, needle nose pliers, diagonal cutters 3-pcs.

Z 99 0 001 01

Order-No.	
26850	1
	Combination pliers Classic with DynamicJoint® and OptiGrip with extra long cutting edge 180mm, 7" (26706)
	Diagonal cutters Classic with DynamicJoint® 160 x 6 1/2" (43332)
	Classic needle nose pliers with cutting edge straight shape 160mm, 6 1/2" (26718)

INFOBOX:  
MagicTips®



Wiha MagicTips® – Top of their class.

- Maximum grip: The special latching function preventing jumping away of the safety rings makes the Wiha circlip pliers truly unique.
- Hard as steel: Additional hardening of tips means high wear resistance and therefore excellent durability.
- Precise: Precision tips of high performance steel for maximum grip and high stability.

### Pliers set Classic with MagicTips®



### Professional BiCut® high-performance diagonal cutters with DynamicJoint®



#### Circlip pliers 4-pcs.

Z 99 0 007 01

Order-No.	
34708	1

#### Supplying / holding

○ Circlip pliers Classic with MagicTips® For inner rings (drill holes) J 1, 140mm (34689) / J 2, 180mm (34690)

○ Circlip pliers Classic with MagicTips® For outer rings (shafts) A 1, 140mm (34699) / A 2, 185mm (34700)

• with safety latching function

#### Switchable

Z 18 0 05

Order-No.	mm	II		Ømm	SB	
38190	200	8	21	3		5
38983	200	8	21	3	x	1

Based on DIN ISO 5749.

### Pliers set Classic



#### Circlip pliers 4-pcs.

Z 99 0 004 01

Order-No.	
26793	1

○ Classic circlip pliers For inner rings (drill holes) J 1, 140mm (26782) / J 2, 180mm (26783)

○ Classic circlip pliers For outer rings (shafts) A 1, 140mm (26790) / A 2, 180mm (26791)

### High-performance diagonal cutters BiCut® Industrial with DynamicJoint®



#### Switchable

Z 18 0 02

Order-No.	mm	II		Ømm	SB	
38189	200	8	21	3		5
38982	200	8	21	3	x	5

Based on DIN ISO 5749.

## INFOBOX: Professional pliers Industrial pliers



#### Professional

#### Industrial

- Professional: pliers, chrome-plated
- Industrial: pliers, polished/black oxidised



**BiCut® Classic high-performance diagonal cutters with DynamicJoint®**



**Switchable**

**Z 18 0 01**

Order-No.	mm	in	Scissors	Ømm	SB	Icon
38060	200	8	21	3		5
38981	200	8	21	3	x	5

Based on DIN ISO 5749.

**Industrial diagonal cutters with DynamicJoint®**



**Z12102**

Order-No.	mm	in	Scissors	Ømm	SB	Icon
43324	140	5 1/2"	16	1,6		5
43451	140	5 1/2"	16	1,6	x	5
43333	160	6 1/2"	17	2		5
43456	160	6 1/2"	17	2	x	5
43338	180	7"	18	2,8		5
43461	180	7"	18	2,8	x	5

**Professional diagonal cutters with DynamicJoint®**



**Z12105**

Order-No.	mm	in	Scissors	Ømm	SB	Icon
43325	140	5 1/2"	16	1,6		5
43334	160	6 1/2"	17	2		5
43457	160	6 1/2"	17	2	x	5
43339	180	7"	18	2,8		5

**Diagonal cutters Classic with DynamicJoint®**



**Z12101**

Order-No.	mm	in	Scissors	Ømm	SB	Icon
43304	140	5 1/2"	16	1,6		5
43450	140	5 1/2"	16	1,6	x	5
43332	160	6 1/2"	17	2		5
43455	160	6 1/2"	17	2	x	5
43337	180	7"	18	2,8		5
43460	180	7"	18	2,8	x	5

### Heavy-duty diagonal cutters Professional with DynamicJoint®



with switchable opening spring

Z 16 3 05

Order-No.	mm	II	✂	Ømm	SB	
40920	160	6,5	17	2		5
41273	180	7	18	2,3		5
41318	180	7	18	2,3	x	5
41278	200	8	19	2,5		5

### Heavy-duty diagonal cutters Classic with DynamicJoint®



Z 16 2 01

Order-No.	mm	II	✂	Ømm	SB	
40913	160	6,5	17	2		5
41301	160	6,5	17	2	x	5
41261	180	7	18	2,3		5
41311	180	7	18	2,3	x	5
41266	200	8	19	2,5		5
41321	200	8	19	2,5	x	5

### Heavy-duty diagonal cutters Industrial with DynamicJoint®



with switchable opening spring

Z 16 3 02

Order-No.	mm	II	✂	Ømm	SB	
40919	160	6,5	17	2		5
41307	160	6,5	17	2	x	5
41272	180	7	18	2,3		5
41317	180	7	18	2,3	x	5
41277	200	8	19	2,5		5
41327	200	8	19	2,5	x	5

### INFOBOX: Heavy-duty diagonal cutters



#### with switchable opening spring

- Up to 40% more cutting force thanks to optimised leverage.
- Opening spring with on/off function for fatigue-free work.
- Opening spring can be activated with just one hand.

Combination pliers Professional with DynamicJoint® and OptiGrip



with extra long cutting edge

Z 01 0 05

Order-No.	mm	II	Scissors	Ømm	SB	Icon
26704	160	6 ½	16	1.6		5
27327	160	6 ½	16	1.6	x	5
26707	180	7	16	1.8		5
27399	180	7	16	1.8	x	5
26710	200	8	17	2		5

DIN ISO 5746.

Combination pliers Industrial with DynamicJoint® and OptiGrip



with extra long cutting edge

Z 01 0 02

Order-No.	mm	II	Scissors	Ømm	SB	Icon
30979	160	6 ½	16	1.6		5
34565	160	6 ½	16	1.6	x	5
30826	180	7	16	1.8		5
34307	180	7	16	1.8	x	5
30978	200	8	17	2		5
34308	200	8	17	2	x	5

DIN ISO 5746.

INFOBOX:  
DynamicJoint®



Wiha DynamicJoint® – A new dimension in strength and durability

- Innovative: Optimised joint construction.
- Effective: Minimal power loss means less force needed for cutting.
- Permanent: Optimal performance even after thousands of cuts.



INFOBOX:  
OptiGrip

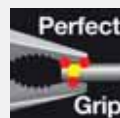

Wiha OptiGrip – optimal grip due to newly designed gripping surfaces

- A firm hold: The „triple-point support“ protects the workpiece from twisting or slipping.
- Highly effective: Optimum grip even with large jaw opening – and at the same time significantly less force needed.
- A wide selection: Now in standard Wiha combination pliers and high leverage combination pliers.





Combination pliers Classic with DynamicJoint® and OptiGrip



with extra long cutting edge

Z 01 0 01

Order-No.	mm	II	✂	Ømm	SB	📏
26703	160	6 ½	16	1.6		5
27325	160	6 ½	16	1.6	x	5
26706	180	7	16	1.8		5
27336	180	7	16	1.8	x	5
26709	200	8	17	2		5
27337	200	8	17	2	x	5

DIN ISO 5746.

High-leverage combination pliers Industrial with DynamicJoint® and OptiGrip



with extra long cutting edge

Z 02 0 02

Order-No.	mm	II	✂	Ømm	SB	📏
32319	200	8	18	2.3		5
32320	225	9	19	2.5		5
34567	225	9	19	2.5	x	5

DIN ISO 5746.

High-leverage combination pliers Professional with DynamicJoint® and OptiGrip



with extra long cutting edge

Z 02 0 05

Order-No.	mm	II	✂	Ømm	SB	📏
26713	200	8	18	2.3		5
26716	225	9	19	2.5		5

DIN ISO 5746.

High-leverage combination pliers Classic with DynamicJoint® and OptiGrip



with extra long cutting edge

Z 02 0 01

Order-No.	mm	II	✂	Ømm	SB	📏
26712	200	8	18	2.3		5
26715	225	9	19	2.5		5

DIN ISO 5746.



### Needle-nose pliers Professional



with cutting edge straight shape

Z 05 0 05

Order-No.	mm	II	✂	Ømm	SB	
26719	160	6 ½	16	1.2		5
26722	200	8	17	1.6		5

DIN ISO 5745.

### Needle-nose pliers Professional



with cutting edge curved shape, approx. 40°

Z 05 1 05

Order-No.	mm	II	✂	Ømm	SB	
26724	160	6 ½	16	1.2		5
26726	200	8	17	1.6		5

DIN ISO 5745.

### Industrial needle nose pliers



with cutting edge straight shape

Z 05 0 02

Order-No.	mm	II	✂	Ømm	SB	
32322	160	6 ½	16	1.2		5
34309	160	6 ½	16	1.2	x	5
32323	200	8	17	1.6		5
34515	200	8	17	1.6	x	5

DIN ISO 5745.

### Industrial needle nose pliers



with cutting edge curved shape, approx. 40°

Z 05 1 02

Order-No.	mm	II	✂	Ømm	SB	
32324	160	6 ½	16	1.2		5
34569	160	6 ½	16	1.2	x	5
32328	200	8	17	1.6		5
34570	200	8	17	1.6	x	5

DIN ISO 5745.

### Classic needle nose pliers



with cutting edge straight shape

Z 05 0 01

Order-No.	mm	II	✂	Ømm	SB	
26718	160	6 ½	16	1.2		5
27340	160	6 ½	16	1.2	x	5
26721	200	8	17	1.6		5
27341	200	8	17	1.6	x	5

DIN ISO 5745.

### Classic needle nose pliers



with cutting edge curved shape, approx. 40°

Z 05 1 01

Order-No.	mm	II	✂	Ømm	SB	
26723	160	6 ½	16	1.2		5
27342	160	6 ½	16	1.2	x	5
26725	200	8	17	1.6		5
27343	200	8	17	1.6	x	5

DIN ISO 5745.

### Plastic diagonal cutters Classic



with opening spring without bevelled edge

Z 15 0 01

Order-No.	mm	II	✂	📦
37402	125	5	2	5
37403	160	6 ½	3	5

DIN ISO 5743.

### Long flat-nose pliers Professional



Z 07 0 05

Order-No.	mm	II	📦
26731	160	6 ½	5

DIN ISO 5745.

### Classic precision mechanic's needle nose pliers



with cutting edge and opening spring in straight shape

Z 36 0 01

Order-No.	mm	II	✂	Ømm	📦
36483	160	6 ½	10	2	5

DIN ISO 5745.

### Long flat-nose pliers Industrial



Z 07 0 02

Order-No.	mm	II	📦
32330	160	6 ½	5
34310	160	6 ½	x

DIN ISO 5745.

### Precision mechanic's diagonal cutters Classic



with opening spring

Z 44 3 01

Order-No.	mm	II	✂	Ømm	📦
36189	125	5	7	0,8	5
43240	125	5	7	0,8	x

DIN ISO 5749.

### Long flat-nose pliers Classic



Z 07 0 01

Order-No.	mm	II	📦
26730	160	6 ½	5
27344	160	6 ½	x

DIN ISO 5745.

### Long round-nose pliers Professional



Z 09 0 05

Order-No.	mm	II	SB	
26734	160	6 ½		5

DIN ISO 5745.

### Long round-nose pliers Classic



Z 09 0 01

Order-No.	mm	II	SB	
26733	160	6 ½		5
27345	160	6 ½	x	5

DIN ISO 5745.

### Long round-nose pliers Industrial



Z 09 0 02

Order-No.	mm	II	SB	
32332	160	6 ½		5
34568	160	6 ½	x	5

DIN ISO 5745.

### Pliers wrench Classic



Z 25 0 01

Order-No.	mm	II	⊙	
40923	250	10	46	6

### INFOBOX: Plier wrench



- Required width setting directly on the work piece with no need to press any buttons
- Ratchet principle allows users to fasten screws rapidly with a simple glide.
- Thanks to its slim design and button-free setting, it is ideal for use in tight spaces.
- Smooth, parallel-acting jaws prevent damage on sensitive surfaces.

### Water pump pliers Professional



#### box type

Z 21 0 05

Order-No.	mm	in	⊘	⊙	SB	
26762	250	10	2	50		5

DIN ISO 8976.

### Water pump pliers Professional



#### with push button

Z 22 0 05

Order-No.	mm	in	⊘	⊙	SB	
26766	250	10	2	50		5

DIN ISO 8976.

### Water pump pliers Industrial



#### box type

Z 21 0 02

Order-No.	mm	in	⊘	⊙	SB	
36038	180	7	1	30		5
36985	180	7	1	30	x	5
32342	250	10	2	50		5
34312	250	10	2	50	x	5
36039	300	12	2 ½	63		5
36986	300	12	2 ½	63	x	5

DIN ISO 8976.

### Water pump pliers Industrial



#### with push button

Z 22 0 02

Order-No.	mm	in	⊘	⊙	SB	
36040	180	7	1	30		5
36987	180	7	1	30	x	1
32352	250	10	2	50		5
34518	250	10	2	50	x	5
36041	300	12	2 ½	63		5
36988	300	12	2 ½	63	x	5

DIN ISO 8976.

### Water pump pliers Classic



#### box type

Z 21 0 01

Order-No.	mm	in	⊘	⊙	SB	
26760	180	7	1	30		5
27350	180	7	1	30	x	5
26761	250	10	2	50		5
27381	250	10	2	50	x	5
26763	300	12	2 ½	63		5
27382	300	12	2 ½	63	x	5

DIN ISO 8976.

### Water pump pliers Classic



#### with push button

Z 22 0 01

Order-No.	mm	in	⊘	⊙	SB	
26764	180	7	1	30		5
27351	180	7	1	30	x	5
26765	250	10	2	50		5
27383	250	10	2	50	x	5
26767	300	12	2 ½	63		5
27384	300	12	2 ½	63	x	5

DIN ISO 8976.



### Water pump pliers QuickFix Professional automatic



automatic

Z 23 1 05

Order-No.	mm	II	O	Ø	SB	
39093	250	10	1 ½	40		1
39095	250	10	1 ½	40	x	5

DIN ISO 8976.

### Heavy-duty end cutting nippers Classic



Z 17 0 01

Order-No.	mm	II	✂	Ømm	SB	
26757	160	6 ½	16	1.6		5
27372	160	6 ½	16	1.6	x	5
26758	180	7	17	1.8		5
27373	180	7	17	1.8	x	5
26759	200	8	18	2		5
27374	200	8	18	2	x	5

DIN ISO 5748.

### Water pump pliers QuickFix Classic



automatic

Z 23 1 01

Order-No.	mm	II	O	Ø	SB	
39091	250	10	1 ½	40		1
39094	250	10	1 ½	40	x	5

### Pincers Classic



Z 30 0 01

Order-No.	mm	II	✂	Ømm	SB	
26771	180	7	12	2		5
27375	180	7	12	2	x	5
26772	200	8	13	2.2		5
27376	200	8	13	2.2	x	5

DIN ISO 9243.

### Monier pliers Classic



Z 31 0 01

Order-No.	mm	II	✂	Ømm	SB	📦
26774	220	8 ¾	16	1.6		5
27377	220	8 ¾	16	1.6	x	5
26776	250	10	17	1.8		5
27378	250	10	17	1.8	x	5
26778	280	11	18	2		5
27379	280	11	18	2	x	5
26780	300	12	18	2		5
27380	300	12	18	2	x	5

DIN ISO 9242.

### Heavy-duty Classic Monier pliers



Z 32 0 01

Order-No.	mm	II	✂	Ømm	SB	📦
40712	300	12	19	2.3		5
41220	300	12	19	2.3	x	5

DIN ISO 8976.

### Monier pliers Classic



without handle cover

Z 31 0 00

Order-No.	mm	II	✂	Ømm	SB	📦
26773	220	8 ¾	16	1.6		5
27501	220	8 ¾	16	1.6	x	5
26775	250	10	17	1.8		5
27502	250	10	17	1.8	x	5
26777	280	11	18	2		5
27503	280	11	18	2	x	5
26779	300	12	18	2		5
27504	300	12	18	2	x	5

DIN ISO 9242.

### Heavy-duty Classic Plus Monier pliers



without handle cover

Z 32 0 10

Order-No.	mm	II	✂	Ømm	SB	📦
40713	300	12	19	2.3		5
41221	300	12	19	2.3	x	5



Classic circlip pliers with MagicTips®, straight



For inner rings (drill holes)

Z 33 4 01

Order-No.	Typ	mm	II	⊙	SB	🔒
34688	J 0	140	5 ½	8-13		5
36975	J 0	140	5 ½	8-13	x	5
34689	J 1	140	5 ½	12-25		5
36225	J 1	140	5 ½	12-25	x	5
34690	J 2•	180	7	19-60		5
36222	J 2•	180	7	19-60	x	5
34691	J 3•	220	9	40-100		5
36272	J 3•	220	9	40-100	x	5
34692	J 4•	305	12	85-140		5

• with safety latching function DIN ISO 5256.

Classic circlip pliers with MagicTips®, angled



For inner rings (drill holes)

Z 33 5 01

Order-No.	Typ	mm	II	⊙	SB	🔒
34693	J 01	140	5 ½	8-13		5
36976	J 01	140	5 ½	8-13	x	5
34694	J 11	140	5 ½	12-25		5
36223	J 11	140	5 ½	12-25	x	5
34695	J 21•	180	7	19-60		5
36224	J 21•	180	7	19-60	x	5
34696	J 31•	220	9	40-100		5
36226	J 31•	220	9	40-100	x	5
34697	J 41•	305	12	85-140		5

• with safety latching function DIN ISO 5256.

Classic circlip pliers with MagicTips®, straight



For outer rings (shafts)

Z 34 4 01

Order-No.	Typ	mm	II	⊙	SB	🔒
34698	A 0	140	5 ½	7-10		5
36977	A 0	140	5 ½	7-10	x	5
34699	A 1	140	5 ½	10-25		5
36978	A 1	140	5 ½	10-25	x	5
34700	A 2•	185	7	19-60		5
36220	A 2•	185	7	19-60	x	5
34701	A 3•	240	9	40-100		5
36219	A 3•	240	9	40-100	x	5
34702	A 4•	300	12	85-140		5

• with safety latching function DIN ISO 5254.

Classic circlip pliers with MagicTips®, angled



For outer rings (shafts)

Z 34 5 01

Order-No.	Typ	mm	II	⊙	SB	🔒
34703	A 01	140	5 ½	7-10		5
36979	A 01	140	5 ½	7-10	x	5
34704	A 11	140	5 ½	10-25		5
36980	A 11	140	5 ½	10-25	x	1
34705	A 21•	185	7	19-60		5
36218	A 21•	185	7	19-60	x	1
34706	A 31•	240	9	40-100		5
36221	A 31•	240	9	40-100	x	5
34707	A 41•	300	12	85-140		5

• with safety latching function DIN ISO 5254.



### Classic circlip pliers, straight



#### For inner rings (drill holes)

Z 33 0 01

Order-No.	Typ	mm	II	⊙	
26781	J 0	139	5 ½	8-13	5
26782	J 1	140	5 ½	12-25	5
26783	J 2	180	7	19-60	5
26784	J 3	225	9	40-100	5
29425	J 4	310	12	85-140	5

DIN ISO 5256.

### Classic circlip pliers, angled



#### For inner rings (drill holes)

Z 33 1 01

Order-No.	Typ	mm	II	⊙	
26785	J 01	139	5 ½	8-13	5
26786	J 11	140	5 ½	12-25	5
26787	J 21	180	7	19-60	5
26788	J 31	225	9	40-100	5
29427	J 41	310	12	85-140	5

DIN ISO 5256.

### Classic circlip pliers, straight



#### For outer rings (shafts)

Z 34 0 01

Order-No.	Typ	mm	II	⊙	
26789	A 0	139	5 ½	3-10	5
26790	A 1	140	5 ½	10-25	5
26791	A 2	180	7	19-60	5
26792	A 3	225	9	40-100	5
29428	A 4	310	12	85-140	5

DIN ISO 5254.

### Classic circlip pliers, angled



#### For outer rings (shafts)

Z 34 1 01

Order-No.	Typ	mm	II	⊙	
26794	A 01	139	5 ½	3-10	5
26795	A 11	140	5 ½	10-25	5
26796	A 21	180	7	19-60	5
26797	A 31	225	9	40-100	5
29429	A 41	310	12	85-140	5

DIN ISO 5254.

## INFOBOX: MagicTips®



### Wiha MagicTips® – Top of their class.

- Maximum grip: The special latching function preventing jumping away of the safety rings makes the Wiha circlip pliers truly unique.
- Hard as steel: Additional hardening of tips means high wear resistance and therefore excellent durability.
- Precise: Precision tips of high performance steel for maximum grip and high stability.



### Corner pipe pliers Classic



#### S-mouth

Z 26 0 00

Order-No.	mm	O:	Icon	Icon
29435	320	1	0-40	1
29436	420	1 ½	0-55	1
29437	535	2	0-67	1

DIN 5234.

### Corner pipe pliers Classic



#### 90°

Z 26 2 00

Order-No.	mm	O:	Icon	Icon
29441	320	1	0-40	1
29442	415	1 ½	0-55	1
29443	555	2	0-67	1

DIN 5234.

### Professional revolving punch pliers



Z 65 0 05

Order-No.	mm	II	Ø	Icon
28402	225	9	2,0-4,5	5

### Revolving punch and loop pliers Professional



Z 65 2 05

Order-No.	mm	II	Ø	Icon
29550	225	9	4,0-5,0	5

## Gripping pliers Classic



### with wire cutter

Z 66 0 00

Order-No.	mm	II	○	□	
29485	180	7	8-30	0-20	5
29486	250	10	8-40	0-20	5
29487	300	12	8-65	0-30	5

## Bolt cutter Classic



Z 27 0 01

Order-No.	mm	II	✂	Ømm	
39374	450	18	6	6	1
39376	600	24	7	8	1
39378	750	30	8	9	1
39380	900	36	9	11	1

## Replacement cutter head



### for bolt cutter Classic

Z 27 0 01K

Order-No.	✂	Ømm	
39375	6	6	1
39377	7	8	1
39379	8	9	1
39381	9	11	1



Pliers set Professional ESD



Diagonal cutters, oblique end cutting nippers, needle nose pliers, 4-pcs. in tool pouch

Z 99 0 001 04

Order-No.	
33507	1
	Diagonal cutters Professional ESD wide, pointed head without bevelled edge 115mm, 4 1/2" (26821)
	Diagonal cutters Professional ESD wide, semi-rounded head with bevelled edge 115mm, 4 1/2" (26831)
	Oblique end cutting nippers Professional ESD wide head, approx. 29° with small bevelled edge 115mm, 4 1/2" (26835)
	Needle nose pliers Professional ESD straight 120mm, 4 3/4" (26799)

SMD tweezer set Professional ESD



Mixed 4-pcs. in box

ZP 99 0 140 02

Order-No.	
32349	1
	Universal tweezers Professional ESD Type AA 130mm, AA (32318)
	Precision tweezers Professional ESD Type PSF 130mm, PSF (32325)
	SMD tweezers Professional ESD Type 13 120mm, 13 (32340)
	SMD tweezers Professional ESD Type 59 117mm, 59 (32344)

INFOBOX:  
Electrostatic  
conductive ESD  
tools



Sensitive, electronic components can be damaged even at a very low voltage.

- Dissipative tools by Wiha discharge the electrostatic energy in a controlled, safe manner.
- ESD tools meet the ESD Standard IEC 61340-5-1.
- ESD tool handles have a surface resistance of  $10^6 - 10^9$  Ohm.

Diagonal cutters Professional ESD



narrow, pointed head with bevelled edge

Z 40 1 04

Order-No.	mm	II	✂	Ømm	SB	📦
26808	115	4 ½	7	0.6		5
27442	115	4 ½	7	0.6	x	5

DIN ISO 9654. IEC 61340-5-1.

Diagonal cutters Professional ESD



wide, pointed head with bevelled edge

Z 41 1 04

Order-No.	mm	II	✂	Ømm	SB	📦
26816	115	4 ½	7	1		5
27444	115	4 ½	7	1	x	5

DIN ISO 9654. IEC 61340-5-1.

Diagonal cutters Professional ESD



narrow, pointed head without bevelled edge

Z 40 3 04

Order-No.	mm	II	✂	Ømm	📦
33521	115	4 ½	2	1	5

DIN ISO 9654. IEC 61340-5-1.

Diagonal cutters Professional ESD



wide, pointed head without bevelled edge

Z 41 3 04

Order-No.	mm	II	✂	Ømm	SB	📦
26821	115	4 ½	2	1		5
27445	115	4 ½	2	1	x	5

DIN ISO 9654. IEC 61340-5-1.

Diagonal cutters Professional ESD



narrow, pointed head with small bevelled edge

Z 40 4 04

Order-No.	mm	II	✂	Ømm	SB	📦
26814	115	4 ½	2	1		5
27443	115	4 ½	2	1	x	5

DIN ISO 9654. IEC 61340-5-1.

Diagonal cutters Professional ESD



wide, pointed head and wire trapping spring with small bevelled edge

Z 41 4 04

Order-No.	mm	II	✂	Ømm	SB	📦
26822	115	4 ½	2	1.2		5
27446	115	4 ½	2	1.2	x	5

DIN ISO 9654. IEC 61340-5-1.



### Diagonal cutters Professional ESD



narrow, semi-rounded head with small bevelled edge

Z 43 1 04

Order-No.	mm	II	✂	Ømm	SB	📦
26826	115	4 ½	2	1.2		5
27447	115	4 ½	2	1.2	x	5

DIN ISO 9654. IEC 61340-5-1.

### Oblique end cutting nippers Professional ESD



wide head, approx. 29° with small bevelled edge

Z 46 1 04

Order-No.	mm	II	✂	Ømm	SB	📦
26835	115	4 ½	2	1.2		5
27450	115	4 ½	2	1.2	x	5

DIN ISO 9654. IEC 61340-5-1.

### Diagonal cutters Professional ESD



wide, semi-rounded head with bevelled edge

Z 44 1 04

Order-No.	mm	II	✂	Ømm	SB	📦
26831	115	4 ½	7	1		5
27448	115	4 ½	7	1	x	5

DIN ISO 9654. IEC 61340-5-1.

### End cutting nippers Professional ESD



narrow head with small bevelled edge

Z 47 1 04

Order-No.	mm	II	✂	Ømm	SB	📦
26839	110	4 ¼	2	0.6		5
27452	110	4 ¼	2	0.6	x	5

DIN ISO 9654. IEC 61340-5-1.

### Diagonal cutters Professional ESD



wide, semi-rounded head with small bevelled edge

Z 44 3 04

Order-No.	mm	II	✂	Ømm	SB	📦
26832	115	4 ½	2	1.2		5
27449	115	4 ½	2	1.2	x	5

DIN ISO 9654. IEC 61340-5-1.

### End cutting nippers Professional ESD



wide head with small bevelled edge

Z 47 2 04

Order-No.	mm	II	✂	Ømm	SB	📦
26840	115	4 ½	2	1.4		5
27453	115	4 ½	2	1.4	x	5

DIN ISO 9654. IEC 61340-5-1.

### Needle nose pliers Professional ESD



straight

Z 36 0 04

Order-No.	mm	II	A	B	D	F	
26799	120	4 3/4	9,5	23	6,5	1,4	5
27329	120	4 3/4	9,5	23	6,5	1,4	5
27905	145	5 3/4	12,0	40	7,5	2,0	5

DIN ISO 9655. IEC 61340-5-1.

### Flat-nose pliers Professional ESD



Short, flat jaws

Z 38 0 04

Order-No.	mm	II	SB	
26806	120	4 3/4		5
27441	120	4 3/4	x	5

DIN ISO 9655. IEC 61340-5-1.

### Needle nose pliers Professional ESD



curved form, approx. 45°

Z 36 1 04

Order-No.	mm	II	SB	
26802	120	4 3/4		5
27439	120	4 3/4	x	5

DIN ISO 9655. IEC 61340-5-1.

### Round-nose pliers Professional ESD



Short, rounded jaws

Z 37 0 04

Order-No.	mm	II	SB	
26804	120	4 3/4		5
27440	120	4 3/4	x	5

DIN ISO 9655. IEC 61340-5-1.



Universal tweezers Professional ESD



**Type AA**

ZP 01 0 14

Order-No.	mm	Typ	
32318	130	AA	10

IEC 61340-5-1.

Precision tweezers Professional ESD



**Type 00**

ZP 11 0 14

Order-No.	mm	Typ	
32327	120	00	10

IEC 61340-5-1.

Precision tweezers Professional ESD



**Type GG**

ZP 06 0 14

Order-No.	mm	Typ	
32347	130	GG	10

IEC 61340-5-1.

Precision tweezers Professional ESD



**Type 2a**

ZP 15 0 14

Order-No.	mm	Typ	
32329	120	2a	10

IEC 61340-5-1.

Precision tweezers Professional ESD



**Type PSF**

ZP 07 1 14

Order-No.	mm	Typ	
32325	130	PSF	10

IEC 61340-5-1.

Precision tweezers Professional ESD



**Type 3c**

ZP 16 0 14

Order-No.	mm	Typ	
32346	110	3c	10

IEC 61340-5-1.

Precision tweezers Professional ESD



**Type SS**

ZP 09 0 14

Order-No.	mm	Typ	
32326	135	SS	10

IEC 61340-5-1.

Precision tweezers Professional ESD



**Type 5**

ZP 18 0 14

Order-No.	mm	Typ	
32334	110	5	10

IEC 61340-5-1.



Precision tweezers Professional ESD



Type 7a

ZP 20 1 14

Order-No.	mm	Typ	
32335	120	7a	10

IEC 61340-5-1.

Universal tweezers Professional ESD



Type 40

ZP 46 0 14

Order-No.	mm	Typ	
32343	145	40	10

IEC 61340-5-1.

Precision tweezers Professional ESD



Type 7abb

ZP 20 2 14

Order-No.	mm	Typ	
32336	120	7abb	10

IEC 61340-5-1.

SMD tweezers Professional ESD



Type 59

ZP 50 0 14

Order-No.	mm	Typ	
32344	117	59	10

IEC 61340-5-1.

SMD tweezers Professional ESD



Type 12

ZP 24 0 14

Order-No.	mm	Typ	
32338	120	12	10

IEC 61340-5-1.

SMD tweezers Professional ESD



Type 13

ZP 25 2 14

Order-No.	mm	Typ	
32340	120	13	10

IEC 61340-5-1.



Diagonal cutters Electronic



wide, pointed head without bevelled edge

Z 41 1 03

Order-No.	mm	II	Scissors	Ømm	SB	Icon
26818	130	5 1/2	3	1.3		5
27391	130	5 1/2	3	1.3	x	5

Diagonal cutters Electronic



very narrow, pointed head without bevelled edge

Z 40 0 03

Order-No.	mm	II	Scissors	Ømm	SB	Icon
26812	128	5 1/4	2	0.8		5
27388	128	5 1/4	2	0.8	x	5

Diagonal cutters Electronic



wide, pointed head with small bevelled edge

Z 41 3 03

Order-No.	mm	II	Scissors	Ømm	SB	Icon
26815	135	5 1/4	8	0.8		5
27393	135	5 1/4	8	0.8	x	5

DIN ISO 9654.

Diagonal cutters Electronic



narrow, pointed head and wire trapping spring without bevelled edge

Z 40 1 03

Order-No.	mm	II	Scissors	Ømm	SB	Icon
26813	126	5	2	1		5
27390	126	5	2	1	x	5

Diagonal cutters Electronic



wide, pointed head and wire trapping spring without bevelled edge

Z 41 6 03

Order-No.	mm	II	Scissors	Ømm	SB	Icon
26825	130	5 1/8	3	1.3		5
27395	130	5 1/8	3	1.3	x	5

Oblique cutting nippers Electronic



wide, pointed head without bevelled edge

Z 46 0 03

Order-No.	mm	II	Scissors	Ømm	SB	Icon
26833	130	5 1/4	3	1.3		5
27398	130	5 1/4	3	1.3	x	5

### Oblique end cutting nippers Electronic



very narrow, short head without bevelled edge

Z 46 0 03

Order-No.	mm	II	SB	Ø mm	SB	Icon
26830	125	5	2	0.6		5
27397	125	5	2	0.6	x	5

### Stripping pliers Electronic



Stripping points 0.8-2.6 mm

Z 49 2 03

Order-No.	mm	II	mm²	AWG	SB	Icon
33471	165	6 ½	0,81-2,59	20-10		5
36794	165	6 ½	0,81-2,59	20-10	x	5

### Needle nose pliers Electronic



narrow, short head straight form

Z 36 0 03

Order-No.	mm	II	SB	Icon
26801	150	6		5
27326	150	6	x	5

### Stripping pliers Electronic



Stripping points 0.4-1.3 mm

Z 49 7 03

Order-No.	mm	II	mm²	AWG	SB	Icon
33472	165	6 ½	0,4-1,3	26-16		5
35820	165	6 ½	0,4-1,3	26-16	x	5

### Needle nose pliers Electronic













Narrow, long head, curved about 40°

Z 36 1 03

Order-No.	mm	II	SB	Icon
41015	142	5 ½		5
41222	142	5 ½	x	5



# The cutting capacities for our pliers.

Plastic/ copper/ aluminium electrical cable/electrical cable/ silver wire					Iron nails, brass screws, wire-mesh fencing				
1	2	3	4	5	6	7	8	9	10
	Diagonal cutters for plastic								Precision mechanic's needle nose pliers
	Diagonal cutters Electronic					Precision mechanic's diagonal cutters			
		Oblique cutting nippers Electronic					Electronic diagonal cutters with bevelled edge		
	Electronic micro oblique end cutting nippers								
	Electronic micro diagonal cutters								
	ESD end cutting nippers					ESD diagonal cutters with bevelled edge			
	ESD oblique end cutting nippers								
	ESD diagonal cutters								

Screws, wire rope, wire basket, electric rail

Springs, hardened pins, chains

✂ 11

12

13

14

15

✂ 16

17

18

19

20

✂ 21

TriCut installation pliers

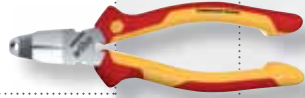

Electrician's diagonal cutters

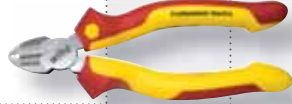

Pincers



Lineman's pliers

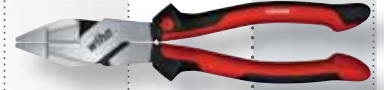

BiCut® Diagonal cutters 100% /

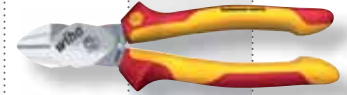

200%

Heavy-duty Monier pliers

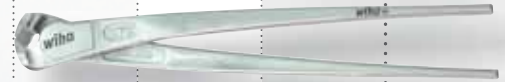

High-leverage combination pliers



Combination pliers

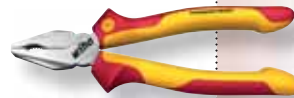

Diagonal cutters

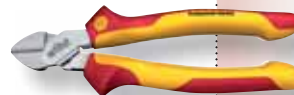

Heavy-duty diagonal cutters



End cutting nippers



Monier pliers



Needle nose pliers

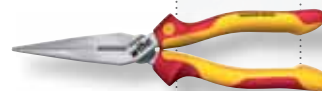

Bent needle nose pliers

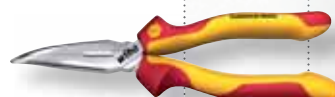



### **Striking and measuring tools. Optimum force transmission**

With optimally uniform weight distribution, the Wiha electric hammer strikes a perfect balance and is also eminently suitable for use in confined working environments. Removing nails and nail clamps as well as fixing cables and dowels into position without causing damage become extremely simple tasks. Wiha's scaled impact screwdriver blade ensures that the portable dowel ratchet makes a perfectly dimensioned dowel hole to the required depth anywhere at any time without making a mess, unlike power tools.

Wiha measuring tools prove to be further dependable helpers during electrical installation work. The Wiha electrician's spirit level allows users to easily mark spaces for up to four flush boxes. This spirit level stands out due to its effortless dimension measurement and perfectly visible bubbles.

## Application Striking and measuring tools.

### Impact tools

**Soft-faced hammer set Safety**  
with assorted hammer faces, 8-pcs. in box  
Page 328



**Soft-faced hammer Safety**  
soft/medium hard, with hickory wooden handle, round hammer face  
Page 329



**Soft-faced hammer dead-blow, medium hard**  
with hickory wooden handle, round hammer face  
Page 332



**Soft-faced hammer dead-blow, medium hard**  
With steel tube handle, round hammer face  
Page 332



**Electrician's hammer**  
with 300 g hammer head, in blister pack  
Page 334



**SoftFinish® dowel racket set**  
with dowels  
Phillips with 6 mm round blade in blister pack, 5-pcs.  
Page 334



### Measurement tools

**Electrician's spirit level**  
40 cm  
Page 335



**Callipers digiMax digital**  
Reading 0.01 mm  
Page 335



**Electrician's Longlife®**  
folding ruler, 2 m  
metric, 10 segments  
Page 336



**Folding ruler LongLife Plus**  
Composite 2 m  
metric, 10 segments  
Page 336





with assorted hammer faces, 8-pcs. in box

832 B8

Order-No.	
44008	1
1 x Hammer face soft Round for soft-faced safety hammer	
2 x Hammer face medium soft Round for soft-faced safety hammer	
2 x Hammer face medium hard Round for soft-faced safety hammer	
2 x Hammer face hard Round for soft-faced safety hammer	
1 x Hammer face very hard Round for soft-faced safety hammer	
1 x Hickory wooden handle for safety soft-faced hammer	
1 x Hammer housing set with screw and locknut for Safety soft-faced hammer	
	1 x L-keys Hexagonal ball end matt chrome-plated

**INFOBOX:**  
**Colour code system for Wiha hammer faces**



**Safety note:**

- Always wear safety glasses and safety gloves when working with soft-faced hammers. Please observe the applicable national standards and regulations.
- Please observe the following tightening torques when replacing heads or handles:
  - Size 30 = 20 Nm
  - Size 40 = 40 Nm
  - Size 50 = 70 Nm
  - Size 60 = 70 Nm
  - Size 80 = 80 Nm

**Hammer face**

- soft (blue)
- medium soft (black)
- medium hard (yellow)
- hard (orange)
- very hard (white)

**Application range**

- for sensitive materials, such as those in furniture and interior construction, minor assembly. Material: elastomer.
- for robust work, such as paving, tiling, dry wall installation. Material: rubber.
- universal use, such as for tool and machine manufacture, car repairs, sheet metal and assembly work. Material: polyurethane.
- for high stress mechanical tasks such as assembly and dismantling work, building and construction work, repair work. Material: cellulose acetate.
- for high impact work, heavy industry and construction, mould construction, road construction, horticulture and landscaping. Material: polyamide.

You will find detailed instructions on replacing at [www.wiha.com](http://www.wiha.com)



Soft-faced hammer Safety soft/medium soft



with hickory wooden handle, round hammer face

832-13

Order-No.	●	⊥	⊥	⊥	⊥	⊥
26649	30	87	290	289		5
26650	40	110	325	637		5
26651	50	131	360	1117		2
26652	60	150	400	1636		2

Soft-faced hammer Safety medium soft/medium hard



with hickory wooden handle, round hammer face

832-35

Order-No.	●	⊥	⊥	⊥	⊥	⊥
26434	30	87	290	295		5
26435	40	110	325	636		5
26436	50	131	360	1100		2
26437	60	150	400	1632		2

Soft-faced hammer Safety soft/medium hard



with hickory wooden handle, round hammer face

832-15

Order-No.	●	⊥	⊥	⊥	⊥	⊥
26653	30	87	290	272		5
26654	40	110	325	620		5
26655	50	131	360	1077		2
26656	60	150	400	1555		2

Soft-faced hammer Safety medium soft/hard



with hickory wooden handle, round hammer face

832-38

Order-No.	●	⊥	⊥	⊥	⊥	⊥
26611	30	87	290	306		5
26612	40	110	325	621		5
26613	50	131	360	1103		2
26614	60	150	400	1620		2

Soft-faced hammer Safety medium soft/medium soft



with hickory wooden handle, round hammer face

832-33

Order-No.	●	⊥	⊥	⊥	⊥	⊥
26509	30	87	290	302		5
26431	40	110	325	640		5
26432	50	131	360	1130		2
26433	60	150	400	1692		2
26439	80	185	490	3136		2



**Soft-faced hammer Safety medium soft/very hard**



with hickory wooden handle, round hammer face

832-99

Order-No.	●	⊥	⊥	↘	⊞
26657	30	87	290	314	5
26658	40	110	325	649	5
26659	50	131	360	1099	2
26660	60	150	400	1682	2
26582	80	185	490	3090	2
26661	80L•	185	840	3324	2

• Sledgehammer

**Hammer face soft**



Round for soft-faced safety hammer

831-1

Order-No.	●	⊥	↘	⊞
26663	30	20.5		5
26664	40	44		5
26665	50	83.5		2
26666	60	136		2

You will find detailed instructions on replacing at [www.wiha.com](http://www.wiha.com)

**Soft-faced hammer Safety medium hard/medium hard**



with hickory wooden handle, round hammer face

832-55

Order-No.	●	⊥	⊥	↘	⊞
26640	30	87	290	296	5
26641	40	110	325	609	5
26642	50	131	360	1120	2
26643	60	150	400	1638	2

**Hammer face medium soft**



Round for soft-faced safety hammer

831-3

Order-No.	●	⊥	↘	⊞
26422	30	30.6		5
26423	40	78		5
26424	50	129.5		2
26425	60	229		2
26426	80•	479		2

• Also for sledgehammers

You will find detailed instructions on replacing at [www.wiha.com](http://www.wiha.com)

**Soft-faced hammer Safety very hard/very hard**



with hickory wooden handle, round hammer face

832-99

Order-No.	●	⊥	⊥	↘	⊞
26644	30	87	290	299	5
26645	40	110	325	602	5
26646	50	131	360	1128	2
26647	60	150	400	1637	2
26648	80	185	490	2940	2
26674	80L•	185	840	3284	2

• Sledgehammer

**Hammer face medium hard**



Round for soft-faced safety hammer

831-5

Order-No.	●	⊥	↘	⊞
26427	30	28.2		5
26428	40	58.5		5
26429	50	117		2
26430	60	189		2

You will find detailed instructions on replacing at [www.wiha.com](http://www.wiha.com)

### Hammer face hard



#### Round for soft-faced safety hammer

831-8

Order-No.	●	t	↕	↕	📦
26615	30	25.5			5
26616	40	53.5			5
26618	50	53			2
26620	60	182.5			2

You will find detailed instructions on replacing at [www.wiha.com](http://www.wiha.com)

### Hammer housing set



#### with screw and locknut for Safety soft-faced hammer

829-0

Order-No.	●	t	↕	↕	📦
26668	30	159			1
26669	40	375			1
26670	50	709			1
26671	60	1017			1
26672	80	1894			1

• Also for sledgehammers

You will find detailed instructions on replacing at [www.wiha.com](http://www.wiha.com)

### Hammer face very hard



#### Round for soft-faced safety hammer

831-9

Order-No.	●	t	↕	↕	📦
26510	30	26.8			5
26511	40	57.4			5
26512	50	112			2
26513	60	191			2
26514	80	395			2

• Also for sledgehammers

You will find detailed instructions on replacing at [www.wiha.com](http://www.wiha.com)

### Hickory wooden handle



#### for safety soft-faced hammer

830-0

Order-No.	●	t	↕	↕	📦
26417	30	260	93		5
26418	40	280	119		5
26419	50	310	190		2
26420	60	340	202		2
26421	80	400	302		2
26667	80L	800	601		1

• for sledgehammer

You will find detailed instructions on replacing at [www.wiha.com](http://www.wiha.com)



Soft-faced hammer dead-blow, very hard



with hickory wooden handle, round hammer face

8001

Order-No.	●	†	⊥	⊥	⊥	⊥	⊥	⊥	⊥
39008	30	115	350	444					5
39010	40	125	375	750					5
39012	50	135	385	1040					2
39014	60	165	420	1700					2

Soft-faced hammer dead-blow, very hard



With steel tube handle, round hammer face

8021

Order-No.	●	†	⊥	⊥	⊥	⊥	⊥	⊥	⊥
39017	30	115	290	556					5
39019	40	125	305	792					5
39021	50	135	365	1276					2
39022	60	165	375	1868					2

Soft-faced hammer dead-blow, medium hard



with hickory wooden handle, round hammer face

800

Order-No.	●	†	⊥	⊥	⊥	⊥	⊥	⊥	⊥
02092	25	108	320	300					5
02093	30	115	350	436					5
02094	35	118	355	543					5
02095	40	125	375	736					5
02096	45	130	380	848					2
02097	50	135	385	1085					2
02098	60	165	420	1710					2
02099	70	165	430	2256					2

Soft-faced hammer dead-blow, medium hard



With steel tube handle, round hammer face

802

Order-No.	●	†	⊥	⊥	⊥	⊥	⊥	⊥	⊥
02122	25	108	288	461					5
02123	30	115	290	558					5
02124	35	118	300	659					5
02125	40	125	305	791					5
02126	45	130	310	935					2
02127	50	135	365	1277					2
02128	60	165	375	1879					2
02129	70	165	385	2571					2

Sledgehammer no recoil, medium hard



with hickory wooden handle, round hammer face

800V

Order-No.	●	†	⊥	⊥	⊥	⊥	⊥	⊥	⊥
02101	80	205	880	4580					2
02091	100	210	1000	6880					1

### Hickory wooden handle



#### for dead-blow soft-faced hammer

800S

Order-No.	●	!	↔	↕	☒
02113	25	295	63		10
02114	30/35	320	105		10
02115	40/45	335	142		10
02116	50	335	145		10
02117	60/70	360	192		5
28051	80•	800	792		1
28052	100•	900	1017		1

You will find detailed instructions on replacing at [www.wiha.com](http://www.wiha.com)

### Hammer face very hard



#### Round for soft-faced no-recoil hammer

8001K

Order-No.	●	!	↔	↕	☒
39149	30	17.4			1
39150	40	69			1
39151	50	67			1
39152	60	115			1

You will find detailed instructions on replacing at [www.wiha.com](http://www.wiha.com)

### Hammer face medium hard



#### Round for soft-faced no-recoil hammer

800K

Order-No.	●	!	↔	↕	☒
02103	25	13.17			10
02104	30	18.4			10
02105	35	26			10
02106	40	37.5			10
02107	45	52.5			5
02108	50	72			5
02109	60	119			5
02110	70	166			5
02111	80	239			2
02102	100	394			2

You will find detailed instructions on replacing at [www.wiha.com](http://www.wiha.com)

### INFOBOX: No-recoil soft-faced hammer



- The special metal filling in the hammer head prevents recoil.
- Approx. 25% more hammer head mass provides additional power.
- Preserves delicate surfaces and edges through high-impact effect.



SoftFinish® dowel racket set with dowels



Phillips with 6 mm round blade in blister pack, 5-pcs.

SB 534S5

Order-No.	
41289	1
1 x Dowel racket	
2 x 30 mm Dowel / 2 x 40 mm Dowel	

Electrician's hammer



with 300 g hammer head, in blister pack

846

Order-No.	
42071	4
23,9	283
500	

INFOBOX:  
SoftFinish® dowel racket set with dowels



- Makes it easier to insert dowels and saves valuable working time.
- Ensures dirt- and dust-free work compared to machines.
- Galvanic separation between the blade and solid steel cap protects against electric shock.
- Perfect for portable use since you can make dowel holes anywhere at any time at the strike of a hammer.

INFOBOX:  
Electrician's hammer



- With its optimally uniform weight distribution, this hammer ensures perfect balance, delivering impact and fatigue-free work.
- Its flat claws make it easier to remove fastening components such as nail clamps, even from difficult-to-access spots.
- Optimum access into corners and confined spaces thanks to U-shaped striking surface.
- The flat hammer handle lower surface acts as a soft-faced hammer, ensuring components such as cables and dowels are fixed into position without causing damage.

## Electrician's spirit level



40 cm

246

Order-No.	mm	g	
42074	400	330	10

### INFOBOX: Electrician's spirit level, 40 cm



- Quick, easy marking of positions for up to four flush boxes in just one simple work step thanks to the integrated marking points.
- The continuous housing allows users to mark lines without interruption.
- An additional scale on the upper surface ensure precise measurement even when viewing from above.
- The bubbles are clearly visible, even from a sharp angle.
- The level is perfectly suitable for portable use thanks to its compact design.



## Callipers digiMax digital



Reading 0.01 mm

4111

Order-No.	mm	g	
29422	150	6	139

CE compliant.

## Callipers caliMax®



Reading 0.1 mm

4113

Order-No.	mm	g	
27083	150	6	74

## Analogue callipers dialMax



Reading 0.1 mm

4112

Order-No.	mm	g	
27082	150	6	104

## Analogue callipers dialMax ESD



Reading 0.1 mm

4112

Order-No.	mm	g	
31439	150	6	96

IEC 61340-5-1.



Electrician's Longlife® folding ruler, 2 m



metric, 10 segments

4102008

Order-No.	Segments	Color	Length (mm)	Quantity
42068	15	orange	135	10

Folding ruler LongLife Plus Composite 2 m



metric, 10 segments

410 2005

Order-No.	Segments	Color	Length (mm)	Quantity
37067	15	red/ black	124	10

Folding ruler Longlife All in One 2 m



metric, 10 segments

410 2007

Order-No.	Segments	Color	Length (mm)	Quantity
33232	15	white	139	10

Folding ruler Longlife 2 m



metric, 10 segments

410 2000

Order-No.	Segments	Color	Length (mm)	Quantity
27058	15	yellow	137	10
27057	15	white	136	10

INFOBOX:  
Electrician's  
Longlife® folding  
ruler, 2 m



- Integrated with cable retractor for cables between 3-7mm.
- Ruler quick and easy to find – even in dark environments with a UV light.
- Ruler with integrated distance marks for up to 3 flush boxes.
- Tool tested at 10,000 V AC and suitable for 1.000 V AC.

INFOBOX:  
Longlife® Plus  
composite folding  
ruler



- High rigidity minimises risk of breakage.
- Tight 90° and 180° latching of all joints.
- Metal ends which cannot be lost on the first and last segment.
- Scale running backwards (recto and verso) enables reading from both sides.



Folding ruler LongLife Plus 2 m



metric, 10 segments

410 2001

Order-No.				
27055	15	yellow	136	10
27059	15	white	136	10

Folding ruler Longlife 1 m



metric, 10 segments









410 1000









Order-No.				
27061	13	yellow	43	10
27062	13	white	43.5	10















# Which page is my product on?













## Screwdrivers, torque tools

Screwdrivers									
									
	Slotted	Phillips PH	Xeno SL/PH	Pozidriv PZ	Xeno SL/PZ	TORX®	TORX® Tamper Resistant	TORX PLUS®	
									
Screwdriver SoftFinish®	•	•		•		•	•	•	
SoftFinish® screwdriver with fixing function	•	•							
SoftFinish® screwdriver with mm scale	•	•		•					
SoftFinish® Stubby screwdriver	•	•		•					
Screwdriver MicroFinish®	•	•		•		•			
Pocket screwdrivers	•								
PicoFinish® fine screwdriver	•	•		•		•		•	
Screwdriver SoftFinish® electric slimFix	•	•	•	•	•	•	•		
Screwdriver SoftFinish® electric	•	•	•	•	•	•			
Bit slimBit electric	•	•	•	•	•	•			
PicoFinish® electric fine screwdriver	•	•							
Voltage tester	•								
Screwdriver SoftFinish® ESD	•	•		•		•			
Fine screwdriver PicoFinish® ESD	•	•		•		•		•	

Torque tools									
									
	Slotted	Phillips PH	Xeno SL/PH	Pozidriv PZ	Xeno SL/PZ	TORX®	TORX® Tamper Resistant	TORX PLUS®	
									
Variably adjustable torque screwdriver	•	•		•		•		•	
Torque screwdriver firmly pre-set	•	•		•		•		•	
Electric torque screwdriver	•	•	•	•	•	•			
Bit slimBit electric	•	•	•	•	•	•			
Torque screwdriver with T-handle						•		•	
TorqueFix® torque screwdriver with key handle						•		•	

												
Internal hexagon	Hexagon head	Square	Square nut	Internal hexagon with drill hole (tamper-resistant)	Triangular nut	Multi-tooth	Tri-Wing®	Torq-Set®	SIT	Spanner	Pentalobe PL	Y-Type

•	•				•							
	•											
•	•										•	•
•	•	•										
•	•	•										
•	•											
•	•											

























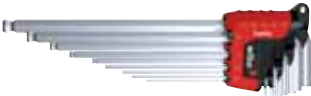

												
Internal hexagon	Hexagon head	Square	Square nut	Internal hexagon with drill hole (tamper-resistant)	Triangular nut	Multi-tooth	Tri-Wing®	Torq-Set®	SIT	Spanner	Pentalobe PL	Y-Type













•	•											
•	•											
•		•										
•		•										
•												
•												
•												















# Which page is my product on?

## Multi-tools, L-keys, bits













Multitools									
									
	Slotted	Phillips PH	Xeno SL/PH	Pozidriv PZ	Xeno SL/PZ	TORX®	TORX® Tamper Resistant	TORX PLUS®	
									
Screwdriver with bit magazine LiftUp electric	•	•		•	•	•			
Screwdriver with bit magazine 26one®	•	•		•		•			
Screwdriver with LiftUp 25 + 70 bit magazine	•	•		•		•			
Screwdriver with bit magazine	•	•		•		•			
Screwdriver with bit magazine Stubby	•	•		•		•			
Multitool PocketStar L-key	•	•				•	•		
Screwdriver with interchangeable blade SYSTEM 6	•	•		•		•	•		
Screwdriver with interchangeable blade SYSTEM 4	•	•		•		•			
L-keys									
									
	Slotted	Phillips PH	Xeno SL/PH	Pozidriv PZ	Xeno SL/PZ	TORX®	TORX® Tamper Resistant	TORX PLUS®	
									
L-keys						•	•	•	
L-key set in ErgoStar holder						•			
L-key set in ProStar holder						•			
L-key set in Compact holder						•			
L-key set in Classic holder						•	•	•	
L-key with T-handle ComfortGrip						•			
L-key with Classic T-handle						•		•	
L-key with T-handle electric						•			
L-key with key handle						•		•	
L-key with flag handle						•		•	
Bits									
									
	Slotted	Phillips PH	Xeno SL/PH	Pozidriv PZ	Xeno SL/PZ	TORX®	TORX® Tamper Resistant	TORX PLUS®	
									
TY-Bit		•		•		•			
T-Bit		•		•		•			
Y-Bit		•		•		•			
Bits with MagicRing®	•	•		•		•	•	•	
Bit with thread	•	•	•	•	•	•	•	•	
Standard bit in C4 size									
Slotted		•		•		•			
Phillips PH	•	•				•			

												
Internal hexagon	Hexagon head	Square	Square nut	Internal hexagon with drill hole (tamper-resistant)	Triangular nut	Multitooth	Tri-Wing®	Torq-Set®	SIT	Spanner	Pentalobe PL	Y-Type

•		•										
•												
•												
•												
•	•						•	•				
•	•											
•	•											

												
Internal hexagon	Hexagon head	Square	Square nut	Internal hexagon with drill hole (tamper-resistant)	Triangular nut	Multitooth	Tri-Wing®	Torq-Set®	SIT	Spanner	Pentalobe Y-Type	Y-Type

•												
•												
•												
•												
•												
•												
•												
•	•		•									
•	•											
•												

												
Internal hexagon	Hexagon head	Square	Square nut	Internal hexagon with drill hole (tamper-resistant)	Triangular nut	Multitooth	Tri-Wing®	Torq-Set®	SIT	Spanner	Pentalobe Y-Type	Y-Type

•		•										
•												
•		•		•		•	•	•	•	•		
•		•						•				
•												
•	•											•







# Wiha order number register

Order-No.		Order-No.		Order-No.		Order-No.	
<b>00</b>		00732	183	00882	173	01024	180
00456	174	00733	183	00894	251	01025	180
00576	227	00734	183	00895	251	01026	180
00577	227	00735	183	00896	251	01027	180
00578	227	00736	183	00897	251	01028	180
00579	227	00737	183	00904	248	01029	180
00580	227	00738	183	00905	248	01030	180
00582	227	00739	183	00906	248	01031	180
00583	227	00740	183	00907	248	01032	180
00584	227	00754	178	00908	248	01033	180
00585	227	00756	178	00909	248	01034	176
00586	227	00757	178	00910	248	01076	180
00587	227	00759	178	00911	248	01077	180
00597	227	00760	178	00912	248	01078	180
00598	227	00762	178	00913	248	01079	180
00599	227	00763	178	00914	248	01081	180
00600	227	00764	183	00915	248	01092	181
00601	227	00765	183	00916	248	01093	181
00602	227	00766	183	00917	248	01094	181
00603	227	00767	183	00918	248	01095	181
00610	225	00768	178	00919	248	01096	181
00613	225	00770	178	00921	248	01097	181
00616	225	00772	178	00922	248	01098	181
00623	221	00774	178	00923	248	01121	244
00629	224	00776	183	00924	248	01122	244
00630	224	00777	183	00926	248	01123	244
00631	224	00778	183	00928	248	01124	244
00632	224	00779	183	00929	248	01126	244
00635	224	00819	173	00930	248	01128	244
00636	224	00820	173	00931	248	01130	244
00637	224	00821	173	00933	248	01131	244
00638	224	00822	173	00934	248	01132	244
00639	224	00823	173	00937	248	01133	244
00654	224	00824	173	00953	239	01134	244
00655	224	00825	173	00965	249	01135	244
00656	224	00826	173	00966	249	01136	244
00657	224	00827	173	00967	249	01137	244
00658	224	00828	173	00968	249	01138	244
00665	224	00829	173	00969	249	01139	244
00666	224	00830	173	00971	249	01140	244
00667	224	00831	173	00972	249	01141	244
00679	183	00832	173	00973	249	01142	244
00683	183	00833	166	00974	249	01143	244
00684	178	00834	166	00975	249	01285	178
00685	178	00846	173	00977	249	01286	178
00686	178	00847	173	00978	249	01287	178
00687	178	00848	173	00979	249	01288	178
00689	178	00849	173	00980	249	01289	178
00690	178	00850	173	00982	249	01290	178
00691	178	00853	174	00983	249	01291	178
00692	178	00855	174	00985	249	01292	178
00694	178	00856	174	00986	249	01293	178
00695	178	00857	174	00988	249	01294	178
00696	178	00858	174	00989	249	01295	178
00697	178	00859	174	00990	249	01296	178
00698	178	00860	174	00991	249	01297	178
00700	178	00861	174	00993	249	01299	175
00701	178	00862	174	00994	249	01300	179
00702	178	00863	174	00995	249	01301	179
00703	178	00864	174	<b>01</b>		01302	179
00704	178	00865	174	01005	249	01303	179
00706	178	00866	174	01006	249	01304	179
00707	178	00867	174	01007	249	01305	179
00708	178	00868	174	01008	249	01306	179
00709	178	00877	173	01018	180	01310	246
00711	178	00878	173	01020	180	01311	246
00712	178	00879	173	01021	180	01312	246
00713	178	00880	173	01022	180	01313	246
00731	183	00881	173	01023	180	01314	246

<b>Order-No.</b>		<b>Order-No.</b>		<b>Order-No.</b>		<b>Order-No.</b>	
01315	246	01475	282	01805	270	02807	249
01316	246	01476	282	01808	271	02808	249
01317	246	01479	282	01809	271	02809	249
01318	246	01481	283	01811	271	02810	249
01319	246	01508	186	01812	271	02811	249
01320	246	01537	186	01894	281	02819	250
01321	246	01538	186	01895	281	02820	250
01322	246	01539	186	01910	281	02821	250
01323	246	01548	186	01913	281	02822	250
01324	246	01623	265	01919	281	02823	250
01326	238	01624	265	01922	278	02824	250
01328	250	01626	265	01923	278	02836	181
01329	250	01627	265	01924	278	02837	181
01330	250	01649	265	01926	278	02838	181
01331	250	01657	265	01927	278	02839	181
01332	250	01658	265	01930	278	02840	181
01333	250	01659	265	01933	278	02939	234
01334	250	01681	265	01935	278	<b>03</b>	
01335	250	01688	265	01937	276	03106	179
01336	250	01689	265	01938	276	03107	179
01337	250	01690	265	01939	276	03108	179
01338	250	01703	266	01940	276	03115	266
01339	250	01704	266	01942	276	03117	266
01340	250	01705	266	01943	276	03186	227
01341	250	01706	266	01945	276	03223	182
01343	250	01707	266	01946	276	03224	182
01345	250	01708	266	01947	277	03225	182
01348	240	01709	266	01948	277	03226	182
01350	251	01710	266	<b>02</b>		03228	182
01351	251	01711	265	02091	332	03230	182
01352	251	01712	265	02092	332	03231	182
01353	251	01713	265	02093	332	03232	182
01354	251	01714	265	02094	332	03237	182
01355	251	01715	265	02095	332	03238	182
01356	251	01716	265	02096	332	03239	182
01391	243	01717	265	02097	332	03245	182
01392	242	01718	265	02098	332	03246	182
01393	242	01719	265	02099	332	03247	182
01395	242	01720	265	02101	332	03591	221
01396	242	01721	265	02102	333	03723	233
01398	242	01722	265	02103	333	03724	252
01400	242	01723	265	02104	333	03725	252
01402	242	01724	265	02105	333	03726	252
01404	242	01726	266	02106	333	03727	252
01406	242	01727	266	02107	333	03728	252
01408	242	01728	266	02108	333	03729	252
01416	233	01729	266	02109	333	03730	252
01418	233	01730	266	02110	333	03731	252
01420	234	01731	266	02111	333	03738	178
01422	243	01732	266	02113	333	03739	178
01423	243	01733	266	02114	333	03760	173
01424	243	01734	266	02115	333	03761	173
01425	243	01735	266	02116	333	03762	173
01426	243	01736	266	02117	333	03764	246
01427	243	01737	266	02122	332	03847	188
01428	243	01738	266	02123	332	03848	188
01429	243	01739	266	02124	332	03849	188
01430	243	01740	266	02125	332	03850	188
01431	243	01790	270	02126	332	03851	188
01432	243	01791	270	02127	332	03852	188
01433	243	01792	270	02128	332	03853	188
01434	243	01793	270	02129	332	03854	188
01435	181	01794	270	02292	233	03868	243
01436	181	01795	270	02568	186	03869	243
01437	181	01796	270	02802	249	03870	243
01438	181	01798	270	02803	249	03871	243
01439	181	01799	270	02804	249	03872	243
01440	181	01800	270	02805	249	03873	243
01443	181	01803	270	02806	249	03874	243

# Wiha order number register

<b>Order-No.</b>		<b>Order-No.</b>		<b>Order-No.</b>		<b>Order-No.</b>	
03875	243	05799	271	08183	189	22594	267
03876	243	05800	270	08184	189	22595	267
03879	234	<b>06</b>		08185	189	22596	272
03882	224	06059	243	08186	189	22597	272
03883	224	06218	244	08421	268	22598	272
03988	188	06358	243	08422	268	22599	272
03992	234	06359	243	08423	268	22600	272
<b>04</b>		06360	243	08424	268	22603	267
04009	270	06361	243	08425	268	22604	267
04010	270	06362	243	08426	268	22605	267
04011	266	06363	243	08900	224	22606	267
04059	271	06364	243	08901	224	22607	267
04096	248	06365	243	08902	224	22608	267
04099	248	06366	243	08903	224	22655	268
04105	248	06367	243	08904	224	22955	266
04108	248	06368	243	08905	224	22956	266
04111	248	06369	243	08906	224	22957	266
04126	270	06370	243	08907	224	22958	266
04127	270	06371	243	08908	224	22959	266
04176	271	06378	234	08909	224	22960	266
04194	273	06379	234	08911	224	22961	266
04195	273	06382	235	<b>09</b>		22962	266
04196	273	06386	234	09393	264	<b>23</b>	
04197	273	06634	267	<b>20</b>		23031	219
04198	273	06635	267	20218	272	23033	219
04204	278	06636	267	20219	272	23035	219
04362	278	06637	273	20220	272	23037	219
04508	278	06638	273	20221	272	23040	219
04509	278	06639	273	20222	272	23041	219
04510	278	06725	188	20223	272	23047	217
04511	278	06726	188	20224	272	23049	217
04512	278	06727	188	20542	268	23051	218
04513	278	06728	188	20549	241	23053	218
04514	278	06729	188	20550	241	23145	272
04515	278	06730	188	20551	241	23147	272
04516	278	06731	188	20552	241	23149	272
04517	278	06732	188	20553	241	23151	272
04631	278	06888	270	20554	220	23159	186
04632	278	06889	271	20555	266	23173	266
04633	278	<b>07</b>		20556	266	23175	266
04634	278	07152	175	20557	266	23177	266
04635	278	07153	175	20558	266	23179	266
04636	278	07155	175	20559	266	23181	266
04637	278	07185	232	20560	266	23183	266
04638	278	07192	232	20570	241	23185	266
04639	278	07855	268	20783	220	23187	266
04640	278	07856	268	<b>21</b>		23189	266
04670	277	07857	268	21045	272	23191	266
04671	277	07859	268	21047	272	23193	266
04677	276	07860	268	21248	176	23195	272
04678	276	07861	268	21249	176	23197	272
04684	278	07869	281	21250	176	23199	272
04685	278	07922	242	21251	176	23201	272
04918	251	07943	264	21960	248	23203	272
04925	266	<b>08</b>		21962	248	23205	272
04926	266	08047	269	<b>22</b>		23207	272
04927	266	08048	269	22096	239	23209	272
04928	266	08049	269	22168	248	23211	272
04929	266	08056	269	22170	248	23213	270
04930	266	08057	269	22172	248	23215	270
04931	266	08058	269	22174	248	23217	270
<b>05</b>		08065	269	22436	189	23219	270
05271	174	08066	269	22509	270	23221	271
05298	265	08067	269	22510	270	23223	271
05300	265	08068	269	22511	270	23225	271
05301	273	08069	269	22512	271	23226	271
05302	273	08070	269	22591	267	23227	271
05303	273	08179	189	22592	267	23228	271
05638	243	08182	189	22593	267	<b>24</b>	



<b>Order-No.</b>		<b>Order-No.</b>		<b>Order-No.</b>		<b>Order-No.</b>	
24107	246	25679	268	26148	204	26260	178
24109	246	25681	268	26151	204	26261	240
24111	246	25739	272	26152	204	26277	204
24113	246	25740	272	26154	204	26278	204
24115	246	25741	272	26155	204	26279	204
24117	246	25742	272	26156	204	26303	179
24119	246	25874	282	26157	204	26304	179
24121	246	25994	266	26158	204	26305	179
24123	246	25996	266	26159	204	26307	179
24189	232	25998	266	26164	247	26309	266
24302	241	<b>26</b>		26165	247	26327	203
24303	241	26000	272	26166	247	26328	179
24304	241	26002	272	26167	247	26329	179
24305	241	26045	267	26168	247	26330	179
24306	241	26047	203	26169	247	26331	179
24307	241	26048	203	26170	247	26332	179
24308	241	26049	203	26171	247	26333	179
24312	237	26051	203	26172	247	26346	266
24313	246	26052	203	26173	247	26347	266
24314	246	26053	203	26174	247	26348	266
24315	246	26058	204	26175	247	26349	266
24316	246	26059	204	26176	247	26350	266
24317	246	26060	205	26177	247	26351	266
24318	246	26061	205	26178	247	26352	267
24319	246	26062	205	26179	283	26353	267
24320	246	26063	205	26181	252	26354	267
24321	246	26064	204	26182	252	26355	267
24322	246	26065	204	26183	252	26356	267
24323	246	26066	204	26184	252	26417	331
24324	246	26067	204	26185	252	26418	331
24325	246	26068	204	26186	252	26419	331
24341	241	26069	204	26187	252	26420	331
24506	175	26070	204	26188	252	26421	331
24515	246	26071	204	26190	179	26422	330
24517	246	26072	204	26191	179	26423	330
24519	246	26073	204	26192	179	26424	330
24521	246	26077	179	26193	179	26425	330
24523	246	26079	179	26194	179	26426	330
24525	246	26081	179	26195	179	26427	330
24527	246	26083	179	26196	204	26428	330
24529	246	26085	179	26197	204	26429	330
24531	246	26087	179	26198	204	26430	330
24533	246	26091	179	26199	204	26431	329
24733	268	26093	179	26200	205	26432	329
24742	268	26095	179	26212	181	26433	329
24746	268	26097	179	26213	181	26434	329
24748	268	26099	179	26214	181	26435	329
24750	268	26101	179	26216	181	26436	329
24851	232	26103	179	26217	181	26437	329
24852	237	26105	179	26221	204	26439	329
24867	272	26107	179	26222	204	26451	268
<b>25</b>		26109	179	26223	204	26454	178
25097	265	26111	179	26224	204	26455	178
25128	218	26113	175	26225	204	26457	179
25130	218	26122	227	26227	204	26458	179
25164	218	26123	227	26228	204	26461	202
25166	218	26124	227	26229	205	26462	202
25293	217	26127	203	26230	180	26463	202
25295	217	26128	203	26231	180	26464	202
25477	166	26129	203	26232	180	26509	329
25553	272	26130	203	26233	180	26510	331
25560	266	26131	203	26234	180	26511	331
25561	266	26133	203	26247	239	26512	331
25562	266	26135	247	26248	239	26513	331
25563	266	26136	247	26249	267	26514	331
25564	266	26137	247	26250	265	26544	205
25572	267	26138	247	26252	265	26582	330
25624	240	26139	247	26253	265	26611	329
25625	240	26140	247	26259	178	26612	329

# Wiha order number register

Order-No.		Order-No.		Order-No.		Order-No.	
26613	329	26729	292	26840	318	27260	267
26614	329	26730	307	26845	294	27325	305
26615	331	26731	307	26846	294	27326	323
26616	331	26732	292	26847	294	27327	304
26618	331	26733	308	26850	300	27328	290
26620	331	26734	308	26852	286	27329	319
26625	195	26735	292	26853	300	27336	305
26626	195	26745	288	26854	300	27337	305
26627	195	26755	145	26864	205	27340	306
26629	209	26757	310	26865	209	27341	306
26640	330	26758	310	26866	209	27342	306
26641	330	26759	310	26888	202	27343	306
26642	330	26760	309	26889	204	27344	307
26643	330	26761	309	26893	202	27345	308
26644	330	26762	309	26901	203	27350	309
26645	330	26763	309	26920	186	27351	309
26646	330	26764	309	26925	203	27368	294
26647	330	26765	309	26928	189	27372	310
26648	330	26766	309	26929	189	27373	310
26649	329	26767	309	26931	178	27374	310
26650	329	26771	310	26953	251	27375	310
26651	329	26772	310	26954	251	27376	310
26652	329	26773	311	26955	251	27377	311
26653	329	26774	311	26956	251	27378	311
26654	329	26775	311	26957	251	27379	311
26655	329	26776	311	26958	251	27380	311
26656	329	26777	311	26959	251	27381	309
26657	330	26778	311	26960	251	27382	309
26658	330	26779	311	26964	183	27383	309
26659	330	26780	311	26965	183	27384	309
26660	330	26781	313	26966	183	27388	322
26661	330	26782	313	26967	183	27390	322
26663	330	26783	313	26968	183	27391	322
26664	330	26784	313	26969	183	27393	322
26665	330	26785	313	26970	183	27395	322
26666	330	26786	313	26971	183	27397	323
26667	331	26787	313	26972	183	27398	322
26668	331	26788	313	26973	183	27399	304
26669	331	26789	313	<b>27</b>		27418	290
26670	331	26790	313	27028	267	27419	290
26671	331	26791	313	27030	267	27420	290
26672	331	26792	313	27055	337	27421	290
26674	330	26793	301	27057	336	27422	291
26703	305	26794	313	27058	336	27423	291
26704	304	26795	313	27059	337	27424	292
26705	290	26796	313	27061	337	27425	292
26706	305	26797	313	27062	337	27426	292
26707	304	26799	319	27064	267	27427	292
26708	290	26801	323	27065	267	27431	288
26709	305	26802	319	27066	267	27437	294
26710	304	26804	319	27067	267	27439	319
26711	290	26806	319	27077	268	27440	319
26712	305	26808	317	27079	204	27441	319
26713	305	26812	322	27082	335	27442	317
26714	290	26813	322	27083	335	27443	317
26715	305	26814	317	27144	189	27444	317
26716	305	26815	322	27145	189	27445	317
26717	290	26816	317	27146	189	27446	317
26718	306	26818	322	27147	189	27447	318
26719	306	26821	317	27148	189	27448	318
26720	291	26822	317	27149	189	27449	318
26721	306	26825	322	27150	189	27450	318
26722	306	26826	318	27151	189	27452	318
26723	306	26830	323	27252	188	27453	318
26724	306	26831	318	27253	188	27501	311
26725	306	26832	318	27256	267	27502	311
26726	306	26833	322	27257	267	27503	311
26727	291	26835	318	27258	267	27504	311
26728	292	26839	318	27259	267	27526	205

<b>Order-No.</b>		<b>Order-No.</b>		<b>Order-No.</b>		<b>Order-No.</b>	
27530	266	27934	250	29159	187	30979	304
27606	186	27935	250	29162	187	<b>31</b>	
27614	252	27936	217	29163	187	31233	244
27615	252	27963	277	29164	187	31234	244
27616	252	27964	251	29165	187	31235	244
27617	252	27965	251	29228	206	31236	244
27618	252	27966	251	29229	206	31237	244
27619	252	27967	251	29230	206	31238	244
27620	252	27968	251	29231	206	31239	244
27621	252	27969	251	29232	206	31240	244
27627	224	27970	251	29233	206	31241	244
27628	224	27971	251	29234	206	31242	244
27629	224	<b>28</b>		29236	206	31243	244
27630	224	28005	179	29416	262	31244	244
27631	224	28026	277	29417	262	31432	189
27632	224	28027	277	29420	299	31439	335
27633	224	28051	333	29422	335	31496	223
27634	224	28052	333	29425	313	31497	223
27635	224	28058	277	29427	313	31498	227
27636	224	28330	297	29428	313	31499	227
27637	224	28372	247	29429	313	31771	174
27638	224	28373	247	29435	314	31863	173
27639	224	28374	247	29436	314	31901	189
27641	189	28375	247	29437	314	31957	271
27712	222	28376	247	29441	314	31958	271
27713	222	28377	247	29442	314	31959	271
27736	179	28402	314	29443	314	31960	270
27737	179	28481	272	29463	283	31961	270
27738	179	28691	201, 207	29466	167	31962	270
27739	179	28734	207	29467	204	31973	272
27740	179	28735	207	29471	242	31975	272
27741	179	28736	207	29472	242	31977	272
27742	179	28737	207	29473	242	<b>32</b>	
27743	179	28738	207	29474	242	32055	268
27744	179	28739	207	29475	242	32070	268
27745	179	28740	207	29485	315	32071	268
27746	175	28741	207	29486	315	32105	270
27753	178	28742	207	29487	315	32160	282
27754	178	28743	207	29544	269	32161	283
27755	178	28744	207	29550	314	32201	174
27756	178	28745	207	29553	204	32250	179
27757	178	28746	207	29554	204	32251	179
27758	178	28747	207	29555	204	32252	179
27811	179	28748	207	29556	204	32253	179
27812	204	28749	207	29557	204	32254	179
27813	204	28756	207	29558	204	32255	179
27814	204	28757	207	29559	204	32256	179
27815	204	28758	207	29560	204	32264	179
27816	204	28760	179	<b>30</b>		32265	179
27817	204	28761	179	30050	266	32281	167
27818	204	28762	179	30066	297	32282	167
27820	225	28763	179	30361	173	32298	222
27892	277	28764	179	30362	173	32299	271
27893	277	28765	179	30363	173	32302	271
27894	277	28766	179	30364	173	32303	271
27895	277	28767	179	30365	173	32304	271
27896	277	28769	179	30366	173	32305	271
27897	277	<b>29</b>		30372	223	32306	271
27898	277	29133	187	30373	227	32307	272
27899	277	29134	187	30404	223	32308	272
27900	277	29135	187	30495	209	32309	272
27901	277	29136	187	30700	173	32310	283
27905	319	29137	187	30701	173	32311	283
27928	250	29138	187	30715	173	32318	320
27929	250	29139	187	30716	173	32319	305
27930	250	29149	187	30824	153	32320	305
27931	250	29150	187	30826	304	32322	306
27932	250	29151	187	30852	204	32323	306
27933	250	29158	187	30978	304	32324	306

# Wiha order number register

Order-No.		Order-No.		Order-No.		Order-No.	
32325	320	32688	271	33841	298	34590	170, 199
32326	320	32689	271	33842	299	34614	202
32327	320	32804	274	33843	299	34686	264
32328	306	32805	273	33844	298	34688	312
32329	320	32806	273	33848	226	34689	312
32330	307	32808	273	33920	272	34690	312
32332	308	32867	182	33921	272	34691	312
32334	320	32868	182	33922	272	34692	312
32335	321	32869	182	33923	272	34693	312
32336	321	32870	182	33924	272	34694	312
32338	321	32871	182	33925	272	34695	312
32340	321	32901	216	33926	272	34696	312
32342	309	32902	216	33927	272	34697	312
32343	321	32903	216	33928	272	34698	312
32344	321	<b>33</b>		33929	272	34699	312
32345	294	33007	216	33930	272	34700	312
32346	320	33008	216	33931	272	34701	312
32347	320	33009	216	33932	272	34702	312
32349	316	33178	291	33961	270	34703	312
32352	309	33186	290	33962	270	34704	312
32383	178	33232	336	33963	270	34705	312
32384	178	33471	323	33964	270	34706	312
32386	244	33472	323	33965	270	34707	312
32387	244	33503	226	33966	270	34708	301
32388	244	33507	316	33969	145	34729	293
32389	244	33520	293	33970	152	34730	293
32390	244	33521	317	33971	152	34736	238
32391	244	33703	270	<b>34</b>		34737	238
32392	244	33704	270	34306	281	34740	235
32393	244	33705	270	34307	304	34741	235
32394	236	33706	271	34308	304	34743	293
32395	236	33707	271	34309	306	34744	293
32396	173	33708	271	34310	307	34745	174
32397	173	33709	271	34312	309	34746	268
32399	178	33710	271	34313	294	<b>35</b>	
32400	178	33711	271	34452	271	35378	174
32404	182	33712	271	34453	271	35389	166
32405	182	33713	271	34454	271	35390	172
32406	182	33714	272	34455	271	35391	172
32409	271	33715	272	34456	271	35392	172
32410	271	33716	272	34457	271	35393	172
32411	271	33717	271	34515	306	35394	172
32412	271	33718	271	34518	309	35395	172
32413	271	33719	271	34533	203	35396	172
32414	271	33720	271	34554	273	35397	182
32415	271	33721	271	34555	273	35398	182
32416	271	33722	272	34556	273	35400	276
32417	271	33723	272	34557	273	35401	276
32418	271	33724	272	34558	273	35402	276
32419	271	33725	272	34559	273	35403	276
32421	271	33726	272	34560	273	35446	172
32423	271	33727	272	34565	304	35456	270
32477	280	33728	272	34567	305	35457	270
32484	283	33729	272	34568	308	35462	292
32486	272	33730	272	34569	306	35465	290
32490	271	33731	272	34570	306	35477	291
32491	271	33732	272	34577	168	35479	293
32492	271	33736	216	34578	170, 199	35480	232
32493	271	33738	216	34579	170, 199	35481	232
32494	271	33740	216	34580	170, 199	35482	242
32495	271	33741	216	34581	170, 199	35483	242
32496	271	33743	216	34582	170, 199	35484	242
32497	271	33744	216	34583	170, 199	35485	242
32505	276	33746	216	34584	170, 199	35486	242
32547	279	33749	244	34585	170, 199	35487	242
32556	279	33750	244	34586	170, 199	35488	242
32573	279	33753	235	34587	170, 199	35489	242
32686	271	33754	235	34588	170, 199	35490	242
32687	271	33764	216	34589	170, 199	35501	172

<b>Order-No.</b>		<b>Order-No.</b>		<b>Order-No.</b>		<b>Order-No.</b>	
35502	172	36288	268	37226	170, 199	38711	273
35503	172	36310	265	37227	170, 199	38712	273
35504	172	36320	203	37351	231	38713	273
35505	172	36321	203	37402	307	38714	273
35506	170, 199	36327	271	37403	307	38715	273
35507	170, 199	36329	172	37450	293	38716	273
35508	170, 199	36330	172	<b>38</b>		38717	273
35509	170, 199	36333	166	38020	144	38718	273
35510	170, 199	36388	151	38060	302	38798	296
35511	170, 199	36389	144	38074	195	38800	208
35538	296	36390	151	38189	301	38801	208
35704	293	36414	205	38190	301	38802	208
35705	293	36415	205	38191	288	38803	208
35709	268	36417	205	38362	166	38804	208
35820	323	36418	205	38370	271	38805	208
35832	268	36421	205	38371	271	38806	208
35834	268	36452	242	38372	271	38807	208
35861	297	36453	233	38552	287	38808	208
35862	297	36454	233	38556	208	38809	208
35870	197	36455	166	38557	208	38810	208
35969	296	36458	238	38558	208	38811	208
<b>36</b>		36459	238	38600	216	38812	208
36038	309	36461	238	38601	216	38813	208
36039	309	36462	238	38605	216	38814	208
36040	309	36483	307	38606	216	38815	208
36041	309	36487	236	38610	214	38816	208
36050	295	36503	235	38611	214	38817	208
36051	296	36521	231	38612	214	38818	208
36052	296	36536	172	38613	214	38819	208
36053	296	36537	172	38616	208	38820	208
36071	170, 199	36538	172	38617	208	38821	208
36072	182	36539	172	38618	208	38853	287
36079	197	36540	172	38619	208	38854	287
36082	273	36541	172	38620	208	38855	290
36085	182	36542	172	38621	208	38856	290
36086	273	36558	166	38622	208	38857	291
36092	281	36711	294	38627	287	38858	291
36093	281	36791	194	38631	293	38859	292
36094	281	36794	323	38632	293	38865	293
36112	281	36800	280	38636	293	38866	293
36114	220	36846	203	38637	286	38867	294
36189	307	36847	203	38649	268	38918	200
36193	273	36849	202	38650	268	38919	200
36217	293	36850	202	38651	268	38920	200
36218	312	36851	209	38652	268	38921	200
36219	312	36852	209	38653	268	38925	200
36220	312	36886	201	38654	268	38926	200
36221	312	36887	201	38656	268	38927	200
36222	312	36888	201	38657	268	38928	200
36223	312	36951	262	38658	268	38929	200
36224	312	36975	312	38659	268	38930	200
36225	312	36976	312	38660	268	38931	200
36226	312	36977	312	38676	273	38932	200
36229	203	36978	312	38677	273	38933	200
36230	203	36979	312	38679	273	38934	200
36231	203	36980	312	38680	273	38935	200
36233	203	36981	293	38681	273	38936	200
36234	203	36985	309	38684	273	38981	302
36235	203	36986	309	38685	273	38982	301
36236	203	36987	309	38686	273	38983	301
36237	203	36988	309	38687	273	38984	288
36238	203	36990	261	38688	273	38985	297
36239	203	<b>37</b>		38689	273	38986	297
36240	203	37067	336	38690	273	<b>39</b>	
36272	312	37147	170, 199	38706	273	39008	332
36275	268	37222	170, 199	38707	273	39010	332
36280	268	37223	170, 199	38708	273	39012	332
36282	268	37224	170, 199	38709	273	39014	332
36285	268	37225	170, 199	38710	273	39017	332



# Wiha order number register

Order-No.		Order-No.		Order-No.		Order-No.	
39019	332	39204	272	40631	275	41147	172
39021	332	39206	273	40632	275	41157	214
39022	332	39207	273	40633	275	41158	214
39029	262	39208	273	40634	275	41159	170, 199
39037	263	39374	315	40635	275	41160	170, 199
39039	263	39375	315	40636	275	41218	291
39040	262	39376	315	40637	275	41220	311
39041	262	39377	315	40638	275	41221	311
39045	263	39378	315	40639	275	41222	323
39049	263	39379	315	40640	275	41223	145
39056	263	39380	315	40641	275	41230	167
39057	263	39381	315	40642	275	41231	164
39059	263	39382	267	40643	275	41232	164
39060	263	39591	178	40644	275	41233	164
39076	220	39875	266	40645	275	41234	214
39078	262	39964	276	40646	276	41235	214
39083	263	39971	274	40647	276	41241	143
39091	310	<b>40</b>		40648	276	41245	166
39093	310	40282	146	40649	276	41246	298
39094	310	40331	282	40650	276	41261	303
39095	310	40342	298	40651	276	41266	303
39104	237	40401	242	40652	276	41272	303
39105	237	40402	242	40653	276	41273	303
39106	245	40403	242	40654	276	41274	289
39107	245	40404	242	40655	276	41275	289
39108	245	40405	242	40656	276	41277	303
39109	245	40406	242	40657	276	41278	303
39110	245	40407	242	40658	276	41279	289
39111	245	40408	242	40659	276	41280	289
39112	245	40409	242	40660	276	41286	160
39113	245	40410	233	40661	276	41289	334
39114	245	40411	233	40663	276	41301	303
39115	245	40461	270	40674	195	41307	303
39116	245	40462	270	40709	291	41309	289
39117	245	40463	270	40712	311	41310	289
39118	245	40464	270	40713	311	41311	303
39124	262	40465	270	40913	303	41317	303
39133	280	40523	140	40919	303	41318	303
39134	280	40600	275	40920	303	41319	289
39149	333	40601	275	40921	289	41320	289
39150	333	40602	275	40922	289	41321	303
39151	333	40603	275	40923	308	41327	303
39152	333	40604	275	40927	291	41329	289
39178	273	40605	275	40948	146	41330	289
39179	273	40606	275	40966	245	41341	196
39180	273	40607	275	40967	245	41342	196
39181	273	40608	275	40968	245	41343	196
39182	273	40609	275	40969	245	41344	196
39183	273	40610	275	40970	245	41345	196
39184	271	40611	275	40971	245	41476	196
39185	271	40612	275	40972	245	41477	196
39186	271	40613	275	40973	245	41478	196
39187	271	40614	275	40974	245	41479	196
39188	272	40615	275	40975	245	41483	230
39189	272	40616	275	40976	245	41585	261
39190	272	40617	275	40977	245	41586	261
39191	272	40618	275	40978	245	41587	261
39192	272	40619	275	40979	236	41588	261
39193	272	40620	275	40980	236	41589	261
39194	272	40621	275	<b>41</b>		41590	261
39195	272	40622	275	41002	175	41591	261
39196	272	40623	275	41003	165	41592	261
39197	272	40624	275	41015	323	41593	261
39198	272	40625	275	41141	172	41594	261
39199	272	40626	275	41142	172	41595	261
39200	272	40627	275	41143	172	41596	261
39201	272	40628	275	41144	172	41597	261
39202	272	40629	275	41145	172	41598	260
39203	272	40630	275	41146	172	41599	260

Order-No.		Order-No.		Order-No.		Order-No.	
41600	260	41901	241	42162	295	42441	185
41601	260	41902	241	42266	156	42442	185
41602	260	41911	156	42267	156	42443	185
41603	260	41912	156	42268	157	42444	185
41604	260	41913	157	42292	260	42445	185
41605	260	41914	158	42293	260	42446	185
41606	260	41915	158	42294	261	42447	185
41607	260	41922	281	42295	261	42448	185
41608	260	41923	299	42301	260	42449	185
41609	260	41973	241	42302	260	42450	185
41610	260	41974	241	42303	261	42451	185
41611	260	41975	241	42304	261	42452	185
41612	260	41976	241	42305	261	42453	185
41613	260	41977	241	42306	260	42454	185
41614	260	41978	241	42374	174	42455	185
41621	260	41979	230	42375	174	42456	185
41622	260	<b>42</b>		42376	174	42457	185
41623	260	42062	295	42377	174	42458	185
41624	261	42068	336	42378	174	42459	185
41625	261	42069	138	42379	174	42460	185
41626	261	42071	334	42380	174	42461	185
41627	261	42074	335	42381	184	42462	185
41628	261	42086	161	42382	184	42463	185
41629	261	42096	258	42383	184	42464	184
41630	261	42097	256	42384	184	42465	184
41631	261	42098	257	42385	184	42466	184
41632	261	42099	256	42386	184	42467	184
41633	261	42100	258	42387	184	42468	184
41634	261	42101	258	42388	184	42469	184
41635	261	42102	258	42389	184	42470	184
41636	261	42103	258	42390	184	42471	174
41637	259	42104	258	42391	184	42474	184
41638	259	42105	258	42392	184	42475	184
41639	259	42106	258	42393	184	42476	184
41640	259	42107	258	42394	184	42477	184
41641	259	42108	258	42395	184	42478	184
41642	259	42109	258	42397	184	42479	184
41643	259	42110	258	42398	184	42480	184
41644	259	42111	258	42399	184	42481	184
41645	259	42112	258	42401	184	42482	184
41646	259	42113	258	42402	184	42483	184
41647	259	42114	256	42403	184	42484	184
41648	259	42115	256	42413	184	42485	184
41649	259	42116	256	42414	184	42486	184
41650	259	42117	256	42415	184	42487	184
41651	259	42118	256	42416	184	42488	184
41652	259	42119	256	42418	184	42489	184
41653	259	42120	256	42419	184	42490	184
41660	259	42121	256	42420	185	42491	184
41662	259	42122	256	42421	185	42492	184
41663	259	42123	256	42422	185	42493	184
41824	259	42124	256	42423	185	42494	184
41825	259	42125	256	42424	185	42501	184
41826	259	42126	256	42425	185	42502	184
41827	261	42127	256	42426	185	42503	184
41828	261	42128	256	42427	185	42504	184
41829	261	42129	256	42428	185	42505	184
41830	258	42130	256	42429	185	42506	184
41831	258	42131	256	42430	185	42507	185
41832	260	42132	256	42431	185	42539	258
41833	260	42133	256	42432	185	42548	258
41834	260	42134	256	42433	185	42549	258
41894	241	42135	257	42434	185	42550	258
41895	241	42136	257	42435	185	42551	258
41896	241	42137	257	42436	185	42766	158
41897	241	42138	257	42437	185	42989	168
41898	241	42139	257	42438	185	42990	177
41899	241	42149	258	42439	185	42991	177
41900	241	42150	258	42440	185	42992	177







# Wiha order number register

Order-No.		Order-No.		Order-No.		Order-No.	
42993	177	43097	149	43458	288	43867	215
42994	177	43098	149	43459	288	43868	215
42996	177	43099	149	43460	302	43869	215
42997	177	43100	150	43461	302	43870	215
42998	177	43101	150	43462	302	43879	142
<b>43</b>		43102	150	43463	288	43882	184
43022	148	43103	150	43464	288	43895	214
43023	147	43104	150	43465	143	43898	209
43024	147	43105	150	43613	214	43994	153
43026	148	43106	150	43631	159	<b>44</b>	
43027	148	43107	150	43634	201	44008	328
43028	148	43108	150	43669	190		
43029	148	43114	170, 199	43670	190		
43030	148	43115	170, 199	43671	190		
43031	148	43116	170, 199	43672	190		
43032	148	43117	170, 199	43673	190		
43033	148	43125	295	43674	190		
43034	148	43128	197	43675	190		
43035	148	43140	170, 199	43676	190		
<b>43036</b>	148	43141	170, 199	43677	190		
43037	148	43142	170, 199	43678	190		
43038	148	43143	170	43679	190		
43039	148	43144	170	43680	190		
43040	148	43145	170	43681	190		
43041	148	43146	170	43682	190		
43042	148	43147	170	43683	190		
43043	148	43148	170	43684	190		
43044	148	43149	170	43685	190		
43052	150	43150	170	43686	190		
43053	150	43151	170	43687	190		
43055	150	43152	169, 197	43688	190		
43056	150	43153	169, 197	43689	190		
43057	150	43154	169, 197	43690	190		
43058	150	43155	169, 198	43691	190		
43061	148	43156	169, 198	43692	190		
43062	149	43157	169, 198	43693	190		
43063	149	43158	169, 198	43694	190		
43065	149	43159	169, 198	43695	190		
43066	149	43160	169, 198	43696	190		
43067	149	43161	169, 198	43697	190		
43068	149	43162	169, 198	43698	190		
43069	149	43163	171	43699	190		
43070	149	43164	171	43700	190		
43071	149	43167	167	43701	190		
43072	149	43177	200	43702	190		
43073	149	43240	307	43703	190		
43074	149	43304	302	43704	190		
43075	149	43324	302	43705	190		
43076	149	43325	302	43706	190		
43077	149	43326	288	43707	189		
43078	149	43327	288	43708	189		
43079	149	43332	302	43709	283		
43080	149	43333	302	43797	160, 174		
43081	149	43334	302	43798	160, 174		
43082	149	43335	288	43847	236		
43083	149	43336	288	43848	235		
43084	149	43337	302	43849	230		
43085	149	43338	302	43850	231		
43086	149	43339	302	43851	230		
43087	149	43340	288	43852	231		
43088	149	43341	288	43858	215		
43089	149	43450	302	43859	215		
43090	149	43451	302	43860	215		
43091	149	43452	302	43861	215		
43092	149	43453	288	43862	215		
43093	149	43454	288	43863	215		
43094	149	43455	302	43864	215		
43095	149	43456	302	43865	215		
43096	149	43457	302	43866	215		







# Wiha article number register

<b>Art.-No.</b>		<b>Art.-No.</b>		<b>Art.-No.</b>		<b>Art.-No.</b>	
<b>22</b>		277P	189, 190	2872 S3	195	328	167, 173
2270P	168, 174	278P	190	2872 T13	195	3281	172
2271P	174	<b>28</b>		2872 T18	194	<b>33</b>	
<b>24</b>		281 01	283	2879 B7	197	331	251
246	335	281 02	282	28799	197	334	239, 248
24601	220	281-01ESD	283	2882	209	334DS	239, 247
246176	295	281P	283	2882 S10	209	334DSR	247
24622	296	2831	164, 167-169, 171, 197, 198, 214	2891	206	334N	250
24628	283	283100	168	2893	206	334R	239, 248
24629	283	283110	170, 199	2893 S01	206	334Z	249
24636	279	283111	170, 199	2899	207	336	249
24667	220	283112	170, 199	28993	207	336N	250
24670	160	283113	170, 199	28995	207	336Z	250
24675	295	283114	170, 199	28996	207	338	249
24676	296	283115	170, 199	28999	207	<b>34</b>	
24677	296	283116	170	<b>29</b>		341	176, 180
24678	296	283117	170, 199	2909	161	343	180
24680	296	283118	170, 199	2920	203	344	181
24681	220	28352	201	2933	200	347	181
<b>25</b>		28360	208	2970	196	347Z	181
255-11	174	283693	208	29701 080 S4	196	<b>35</b>	
25513	160, 174	283695	208	29701 200 S4	196	350	234, 244
25514	160, 174	283696	208	29701 280 S4	196	351P	217, 219
255-3	174	283793	200	29701 S5	196	352B	234, 235, 243
255-7	174	283794	200	<b>30</b>		356	179
<b>26</b>		283795	200	300	183	357	180
260P	177, 184	283799	201	301	183	3581	172
2611P	184	284	223	302	175, 178	358N	173
261P	184	28400	224	3021	182	<b>36</b>	
262P	184	28401	224	3022	178	3611P	238, 246
263P	177, 185	28411	224	302ESD	188, 189	362	175, 178
264P	177, 185	28422	224	302SY	183	362BE	179
264PZ	185	28437	224	308	176, 183	362ESD	188, 189
265P	177, 185	2844	224	<b>31</b>		362IP	179
265PZ	185	28455	224	311	178	362R	175, 179
266P	184	284ESD	223	3111	182	362RIP	179
266PY	184	284T	221, 222	311ESD	189	362TR	175, 179
267P	177, 185	284TR	224	311SY	183	363	238, 246
267PIP	184	284TS	224	312	183	363P	217, 218
267PPR	177, 184	284TW	224	313	178	363TR	238, 246
268P	185	2850	203	313ESD	189	363TRP	218
269	227	2852	202	313SY	183	364	240, 250
26900	227	2852 S10	202	314	183	364DS	239, 247
26901	227	2852 S10-01	202	<b>32</b>		364IP	251
26911	227	2859	205	3201	165, 166, 172	364R	251
2691ESD	227	28590	204	320N	166, 173	365	240, 251
26922	227	28591	204	3211	172	365IP	240, 252
26937	227	28592	204	321N	173	366	237, 238, 246
26955	227	28593	205	322	174	366 TS	245
269ESD	226	28594	205	322 K5	167	366BE	236, 244
269T	225	28595	204	323N	173	366BET	236, 245
269TESD	227	28595R	204	324	173	366R	235, 244
<b>27</b>		28596	204	3241	172	366TS	237
270P	189, 190	28596R	204	325	173	367	179
271P	190	28597	204	3251	166, 172	367R	179
273P	190	285992	205	3251 TR	172	369	232, 233, 242
275P	190	285994	205	3251TR	166	369 Zoll B	243
276P	190	2872	195	327	167, 173	369B	234, 243
276PY	190			3271	172	369F	230, 241

Art.-No.	
369K	233, 242
369R	231, 241
369RF	230, 241
369RP	219
369RZ	231, 241
369T	232, 242
369Z	242
369ZB	232, 234
<b>37</b>	
370	240, 252
370IP	252
372	181
<b>38</b>	
3801	216
3802	214
380302	216
3809	216
384	282
386	282
387 01	282
387 02	282
387ESD	283
388	283
388DS	283
<b>39</b>	
397	182
398	182
<b>40</b>	
400 10	186
405	188
<b>41</b>	
410 1000	337
410 2000	336
410 2001	337
410 2005	336
410 2007	336
4102008	336
4111	335
4112	335
4113	335
<b>43</b>	
430	186
<b>50</b>	
500	186
509	186
<b>53</b>	
530	176, 182
531	182
532	182
<b>54</b>	
540	248
540DS	247
<b>55</b>	
5527	187
5533	187
5534	187
5535	187
<b>59</b>	
590	156, 157, 159

Art.-No.	
5991	158
5992	158
<b>70</b>	
7000 4 Z	275
7000 SK65 ESD	274
7001 4 Z	275
7003 4 Z	275
7005 4 Z	275
7009 4 Z	275
7010 Z	265
7011 DWS	267, 268
7011 Z	265
7011Z	269
7012 Z	265
7012Z	269
7013 Z	266
7013 Z TR	266
7013R Z	266
7015 Z	265
7015 Z TR	266
7015K Z	266
7015Z	269
7016 Z	266
7016 Z IPR	266
7017 Z	266
7017R Z	266
7018 Z	267
7019 Z SIT	267
7019 Z SP	267
7019 Z TS	267
7019 Z TW	267
7019 Z XZN	267
7040 Z	270
7041 Z	270
7042 Z	271
7043 Z	273
7043R Z	272
7044	278
7044 4 Z	276
7044 M	278
7045 Z	271
7045 Z TR	272
7045BE	271
7045BE 9570	274
7045R	271
7046 Z	272
7047R Z	272
7048 Z	273
7049 TS	272
7049PHM	271
7049PZM	271
<b>71</b>	
7103	276
7110	276
7110H	281
7113	281
7113 P	281
7113 S	281
7123	280

Art.-No.	
7140	281
7143	281
7148 CF	280
7148 CS	280
7148C	280
7183	281
<b>72</b>	
7201	278
7203	278
7204Z-516	279
7207NEX	150
7207NHS	150
7207NRW	150
7208NEX	150
7208NHS	150
7210	278
7240	278
<b>73</b>	
7311 Z	276
7312 Z	276
7321 Z	276
7322 Z	276
7325 Z	276
7331 Z	276
7332 Z	277
7341 Z	277
7342 Z	277
<b>74</b>	
7410Z	215
7419Z	215
<b>78</b>	
7802	224
7803	224
7806	277
7807	277
<b>79</b>	
79186 B5	277
79187 B5	277
7928-913	264
7928-923	264
7928-928	264
7930 Z	270
7945	261
7947-005	262
7947-505	262
7947-505TR	263
7947-902	263
7947-904	262
7947-905	262
7947-995	263
7947-999	262
7948-005	262
7948-043	262
7948-927	262
7979-01	265
7979-02	265
7979-03	265
<b>80</b>	
800	332

Art.-No.	
8001	332
8001K	333
800K	333
800S	333
800V	332
802	332
8021	332
<b>82</b>	
829-0	331
<b>83</b>	
830-0	331
831-1	330
831-3	330
831-5	330
831-8	331
831-9	331
832 B8	328
832-13	329
832-15	329
832-33	329
832-35	329
832-38	329
832-39	330
832-55	330
832-99	330
<b>84</b>	
846	334
<b>93</b>	
9300	153
9300-019	152
9300-020	152
9300-024	151
9300-026	151
9300-041	153
<b>SB</b>	
SB 3803 04 020	214
SB 430 40 K10	186
SB 430 4010	186
SB 534S5	334
SB 7945-TY202	257
SB 7945-TY303	257
SB 7945-TY505	257
SB 7945-TY903	257
SB 7945-TY904	257
SB 7945-TY905	257
SB 7946-TY202	256
SB 7946-TY303	256
SB 7946-TY505	256
SB 7946-TY903	256
SB 7946-TY904	256
SB 7946-TY905	256
SB 7947-005	263
SB 7947-505	263
SB 7947-505TR	263
SB 7947-902	263
SB 7947-904	263
SB 7947-999	263
SB 7947-T303	259
SB 7947-T906	259

# Wiha article number register

Art.-No.		Art.-No.		Art.-No.	
SB 7947-T999	259	Z 22 0 01	309	Z 57 0 001 06K	295
SB 7947-Y202	261	Z 22 0 02	309	Z 57 0 06	295
SB 7947-Y505	261	Z 22 0 05	309	Z 60 0 01	297
SB 7947-Y904	261	Z 22 0 06	293	Z 60 0 06	297
SB 7948-T950	258	Z 23 1 01	310	Z 62 0 06	298, 299
SB 7948-T999	258	Z 23 1 05	310	Z 65 0 05	314
SB 7948-Y505	260	Z 25 0 01	308	Z 65 2 05	314
SB 7948-Y904	260	Z 26 0 00	314	Z 66 0 00	315
SB 7948-Y950	260	Z 26 2 00	314	Z 71 5 06	299
<b>Z</b>		Z 27 0 01	315	Z 71 7 06	299
Z 01 0 01	305	Z 27 0 01K	315	Z 99 0 001 01	300
Z 01 0 02	304	Z 30 0 01	310	Z 99 0 001 04	316
Z 01 0 05	304	Z 31 0 00	311	Z 99 0 001 06	286
Z 01 0 06	290	Z 31 0 01	311	Z 99 0 001 09	286
Z 01 0 09	290	Z 32 0 01	311	Z 99 0 002 01	300
Z 02 0 01	305	Z 32 0 10	311	Z 99 0 002 05	300
Z 02 0 02	305	Z 33 0 01	313	Z 99 0 004 01	301
Z 02 0 05	305	Z 33 1 01	313	Z 99 0 007 01	301
Z 02 0 06	290	Z 33 4 01	312	Z12101	302
Z 02 0 09	290	Z 33 5 01	312	Z12102	302
Z 02 2 01	291	Z 34 0 01	313	Z12105	302
Z 02 2 02	291	Z 34 1 01	313	ZP	
Z 05 0 01	306	Z 34 4 01	312	ZP 01 0 14	320
Z 05 0 02	306	Z 34 5 01	312	ZP 06 0 14	320
Z 05 0 05	306	Z 36 0 01	307	ZP 07 1 14	320
Z 05 0 06	291	Z 36 0 03	323	ZP 09 0 14	320
Z 05 0 09	291	Z 36 0 04	319	ZP 11 0 14	320
Z 05 1 01	306	Z 36 1 03	323	ZP 15 0 14	320
Z 05 1 02	306	Z 36 1 04	319	ZP 16 0 14	320
Z 05 1 05	306	Z 37 0 04	319	ZP 18 0 14	320
Z 05 1 06	292	Z 38 0 04	319	ZP 20 1 14	321
Z 05 1 09	292	Z 40 0 03	322	ZP 20 2 14	321
Z 07 0 01	307	Z 40 1 03	322	ZP 24 0 14	321
Z 07 0 02	307	Z 40 1 04	317	ZP 25 2 14	321
Z 07 0 05	307	Z 40 3 04	317	ZP 46 0 14	321
Z 07 0 06	292	Z 40 4 04	317	ZP 50 0 14	321
Z 09 0 01	308	Z 41 1 03	322	ZP 99 0 140 02	316
Z 09 0 02	308	Z 41 1 04	317		
Z 09 0 05	308	Z 41 3 03	322		
Z 09 0 06	292	Z 41 3 04	317		
Z 12 1 06	288	Z 41 4 04	317		
Z 12 1 09	288	Z 41 6 03	322		
Z 14 0 06	288	Z 43 1 04	318		
Z 14 1 01	287	Z 44 1 04	318		
Z 14 1 06	287	Z 44 3 01	307		
Z 15 0 01	307	Z 44 3 04	318		
Z 16 2 01	303	Z 46 0 03	322, 323		
Z 16 3 02	303	Z 46 1 04	318		
Z 16 3 05	303	Z 47 1 04	318		
Z 16 3 06	289	Z 47 2 04	318		
Z 16 3 09	289	Z 49 2 03	323		
Z 17 0 01	310	Z 49 7 03	323		
Z 18 0 01	302	Z 50 1 01	293		
Z 18 0 02	301	Z 50 1 06	293		
Z 18 0 05	301	Z 50 1 09	293		
Z 18 0 06	288	Z 55 0 01	294		
Z 21 0 01	309	Z 55 0 02	294		
Z 21 0 02	309	Z 55 0 05	294		
Z 21 0 05	309	Z 55 0 06	294		
Z 21 0 06	293	Z 55 0 09	294		



# Legend

## Drives

	Triangular nut
	Hexagon head
	Square nut
	Internal hexagon
	Internal hexagon with drill hole (tamper-resistant)
	Tamper Resistant hex
	Countersink
	Combination drill bit
	Pentalobe PL
	Y-Type
	Phillips PH (cross-recessed)
	Pozidriv PZ (Phillips)
	Robertson
	Round tip
	Slotted
	Slotted nut
	SIT
	Spanner
	Twist drill
	Sliding sleeve
	Torq-Set®
	TORX®
	TORX® with drill hole (tamper-resistant)
	TORX PLUS®
	Tri-Wing®
	Multitooth
	Square reaming blade
	Xeno SL/PZ

## Drives

	Square nut
	Square
	G7 drive system
	Threaded connector
	SDS-Plus®
	Hex

## Screwdrivers [mm]

	Cut width
	Tip width
	Round blade dimension
	Hex blade
	Hex bolster
	Scraper width
	Clip opening
	Tip width
	Head width, nut driver
	Blade length
	Shaft lengths
	Handle length
	Handle diameter
	Torque T-handle length
	Torque T-handle width
	Max. torque value [Nm]
	Max. torque value [in.lbs]
	Accuracy [%]
	Cable key depth

## L-keys [mm]

	Round blade dimension
	Hex blade
	Hex bolster
	Shaft lengths
	Blade length
	Side driver length T-handle
	Handle width
	Diameter

## Bits [mm]

	Threaded connector
	Drill working length
	Screw size

## Pliers [mm]

	Flat jaws
	Half round jaws
	Round jaws
	Cutter without bevel
	Cutter with small bevel
	Cutter with bevel
	Anvil cutter
	Center cutter
	Scissors cutter
	Front cutting edge in stripping pliers
	Max. diameter
	Max. cross-section
	Max. gripper pipe diameter
	Max. gripper width across flats
	External retaining ring
	Internal retaining ring
	Clamping range
	Opening width flat
	Cutting force
	with opening spring
	AWG American Wire Gauge
	Saw blade length

## Measurement tools [mm]

	Width of segments
	Colour
	Measurement capacity [mm]
	Measurement capacity in Inch

## Electro

	Battery
	LED lumens
	Laser light

## Soft faced hammer [mm]

	Face diameter
	Hammer face width
	Hammer head width

## General symbols

	Weight, g
	Diameter
	Blister packed
	Total length mm
	Total length Inch
	Packaging unit

TORX®, TORX PLUS®= Registered Trademarks of ACUMENT GlobalTechnologies B.V.  
 ACR/AOT, Tri-Wing®, Torq-Set®= Registered Trademarks of Phillips Screw Company  
 Pozidriv= Registered Trademark of European Industrial Services Ltd.

# Legend

## Ranges



Case strength



Wheel-along case



Case shape



Case suitable for transport by air

## Electro



Torque safety check



Saves time

## Screwdrivers



MagicRing®



MagicSpring®



Ball end can swivel up to 25°



slimTECHNOLOGY

## Torque



Precision: ±6%



Accuracy ±10%



slimTECHNOLOGY

## L-keys



MagicRing®



MagicSpring®



Ball end can swivel up to 25°



TORX® ball end; can swivel up to 25°



Visible in UV light



95° Stubby

## Bits



Suitable for impact screwdrivers



Lifespan 120 times longer



Visible in UV light

## Pliers



Cutting-to-length diameter



Skinning diameter length



Automatic skinning



DynamicJoint®



Heavy-duty diagonal cutters



OptiGrip



MagicTips®



BiCut® Power



TriCut®

## Impact tools



Optimum weight distribution



Soft hammer end



Levers out nail clamp

## Measurement tool



Fully encased



Visible from just 10°



Visible in UV light

## General information



Recommended for electricians – non-insulated



VDE-tested and certified



CE marking



ESD electronics mark

Subject to technical changes. All illustrations and graphics, specified dimensions and values and references to standards, e.g. DIN/EN, are non-binding. Any liability claims based on this will therefore be rejected. No liability claims will be accepted for printing errors and mistakes which have occurred during the production of the catalogue.

All property rights to the catalogue held by Wiha Werkzeuge GmbH are reserved. The printing or copying of the texts and illustrations contained in this catalogue or its design is prohibited. Our General Terms and Conditions (Terms of Sale, Delivery and Payment) apply. You will find our general terms and conditions at [www.wiha.com](http://www.wiha.com)

**Wiha Werkzeuge GmbH**  
**Obertalstraße 3-7**  
78136 Schonach/Germany  
Phone +49 7722 959-0  
Fax +49 7722 959-159 Inland  
Fax +49 7722 959-155 Export  
info.de@wiha.com  
www.wiha.com

**Wiha Tools Ltd.**  
841 Birchwood Boulevard  
Warrington  
WA3 7QU  
Phone +44 1527 57 57 58  
+44 1527 91 09 86  
Fax +44 1527 91 00 23  
info.uk@wiha.com  
www.wiha.com/en

**Wiha France SARL**  
Z. A. de Terrefort  
33520 Bruges/France  
Phone +33 5 56 16 79 35  
Fax +33 5 56 16 79 36  
servicecommercial@wiha.fr  
www.wiha.com/fr

**Wiha Nordic A/S**  
Korskildelund 6  
2670 Greve/Denmark  
Phone +45 70 23 80 45  
info.nordic@wiha.com  
www.wiha.com

**Wiha Iberia Willi Hahn S.A.**  
Av. del Rey Juan Carlos I, 98. 3º C  
28916 Leganés/Madrid, Spain  
Phone +34 91 693 85 11  
Fax +34 91 693 63 83  
iberia@wiha.com  
www.wiha.com/es

**Wiha Polska Sp. z o.o.**  
ul. Budowlanych 10b  
80-298 Gdańsk/Poland  
Phone +48 58 762 38 30  
Fax +48 58 762 39 00  
info.pl@wiha.com  
www.wiha.com/pl

**Wiha in Russia**  
Phone +48 58 762-38-30  
Fax +48 58 762-39-00  
michal.moczynski@wiha.com  
www.wiha.com

**Willi Hahn Corp.**  
1348, Dundas Circle  
Monticello, MN 55362/USA  
Phone +1 763 2 95 65 91  
Fax +1 763 2 95 65 98  
cservice@wihatools.com  
www.wihatools.com

**Wiha Tools Canada Ltd.**  
394 Deerpark Drive  
L6T 5H9, Brampton, ON  
Phone +1 866 494 0096  
Fax +1 800 494 7456  
info@wihatools.ca  
www.wihatools.ca

**Wiha Asia Pacific Pte. Ltd.**  
25 International Business Park  
#02 – 102 German Centre  
Singapore 609916  
Phone +65 6563 1277  
Fax +65 6563 7168  
info.sg@wiha.com  
www.wiha.com

**Wiha Tools (Shanghai) Co.Ltd.**  
Tony Lv  
Zone B No.1000 Jinsui Rd,  
Pudong New District Shanghai,  
China, 201206  
Phone +86 21 64401119  
Fax +86 21 64401112  
info.cn@wiha.com.cn  
www.wiha.com.cn

**Wiha Finland Oy**  
Mäkituvantie 9  
FI-01510 Vantaa Finland  
Phone +358 44 231 9988  
raija.helin@wiha.com  
www.wiha.com

**Wiha en Belgique**  
Phone +32 49 35 054 50  
info.belux@wiha.com  
www.wiha.com

**Wiha in Nederland**  
Phone +31 64 63 113 30  
info.nl@wiha.com  
www.wiha.com/nl

**Wiha in Italia**  
Thoelke Rappresentanze Srl  
Phone +39-0332-966039  
info.it@wiha.com  
www.wiha.com/it

**Premium Tools Australia Pty Ltd.**  
PO Box 63  
Bargo, NSW 2574  
Phone +61 02 4684 1460  
Fax +61 02 8088 7272  
sales@wiha.com.au  
www.wiha.com.au

**Premium Tools (NZ) Ltd.**  
Unit 5C 89 Ellice Road  
Wairau Valley  
Auckland, New Zealand  
Phone +64 09 444 2560  
Fax +64 09 355 0411  
sales@wiha.co.nz  
www.wiha.co.nz

**Robert Rieffel AG**  
Widenholzstrasse 8  
8304 Wallisellen/Switzerland  
Phone +41 44 877 33 33  
Fax +41 44 877 33 22  
info@rieffel.ch  
www.rieffel.ch



## X-ON Electronics

Largest Supplier of Electrical and Electronic Components

*Click to view similar products for [Screwdrivers, Nut Drivers & Socket Drivers](#) category:*

*Click to view products by [Wiha](#) manufacturer:*

Other Similar products are found below :

[272012M](#) [27850](#) [CE-16-03400-00-HNDLE-TORQ](#) [323451-000](#) [HMM-HH](#) [WUVT-1-120AC-P](#) [00-8987-YWPP](#) [32024](#) [XW4Z-00B](#)  
[49-22-4073](#) [96025](#) [96030](#) [96560](#) [96430](#) [31830](#) [92270](#) [96012](#) [96436](#) [96536](#) [92064](#) [72820](#) [96520](#) [92040](#) [96416](#) [96570](#) [72823](#) [96525](#) [96720](#)  
[31832](#) [92020](#) [96523](#) [96510](#) [96427](#) [92073](#) [92052](#) [72905](#) [72741](#) [72663](#) [32061](#) [30751](#) [130203/TA](#) [KLEIN TOOLS SCREWDRIVER 4-IN-1](#)  
[612020B](#) [35-045](#) [6951](#) [83](#) [9058](#) [9977](#) [EMF](#) [PTE6](#)