

**Wiha Werkzeuge GmbH**

**Obertalstraße 3-7**  
 78136 Schonach/Germany  
 Phone +49 7722 959-0  
 Fax +49 7722 959-159 Inland  
 Fax +49 7722 959-155 Export  
 info.de@wiha.com  
 www.wiha.com

**Wiha Tools Ltd.**

17 The Courtyard  
 Buntsford Gate  
 Bromsgrove B60 3DJ  
 Phone +44 1527 57 57 58  
 +44 1527 91 09 86  
 Fax +44 1527 91 00 23  
 info.uk@wiha.com  
 www.wiha.com/en

**Wiha France SARL**

Z. A. de Terrefort  
 33520 Bruges/France  
 Phone +33 5 56 16 79 35  
 Fax +33 5 56 16 79 36  
 servicecommercial@wiha.fr  
 www.wiha.com/fr

**Wiha Nordic A/S**

Korskildelund 6  
 2670 Greve/Denmark  
 Phone +45 70 23 80 45  
 info.nordic@wiha.com  
 www.wiha.com

**Wiha Iberia Willi Hahn S.A.**

Av. del Rey Juan Carlos I, 98. 3°C  
 28916 Leganés/Madrid, Spain  
 Phone +34 91 693 85 11  
 Fax +34 91 693 63 83  
 iberia@wiha.com  
 www.wiha.com/es

**Wiha Polska Sp. z o.o.**

ul. Budowlanych 10b  
 80-298 Gdańsk/Poland  
 Phone +48 58 762 38 30  
 Fax +48 58 762 39 00  
 info.pl@wiha.com  
 www.wiha.com/pl

**Wiha in Russia**

Phone +48 58 762-38-30  
 Fax +48 58 762-39-00  
 michal.moczynski@wiha.com  
 www.wiha.com

**Willi Hahn Corp.**

1348, Dundas Circle  
 Monticello, MN 55362/USA  
 Phone +1 763 2 95 65 91  
 Fax +1 763 2 95 65 98  
 cservice@wihatools.com  
 www.wihatools.com

**Wiha Tools Canada Ltd.**

394 Deerpark Drive  
 L6T 5H9, Brampton, ON  
 Phone +1 866 494 0096  
 Fax +1 800 494 7456  
 info@wihatools.ca  
 www.wihatools.ca

**Wiha Asia Pacific Pte. Ltd.**

25 International Business Park  
 #02-102 German Centre  
 Singapore 609916  
 Phone +65 6563 1277  
 Fax +65 6563 7168  
 info.sg@wiha.com  
 www.wiha.com

**Wiha Tools (Shanghai) Co.Ltd.**

Rm14B Zhaofeng  
 Universe Building  
 1800 Zhongshanxi Road  
 Shanghai 200235  
 China  
 Phone +86 21 6440 1119  
 Fax +86 21 6440 1112  
 info@wiha.com.cn  
 www.wiha.com.cn

**Wiha en Belgique**

Phone +32 49 35 054 50  
 info.belux@wiha.com  
 www.wiha.com

**Wiha in Nederland**

Phone +31 64 63 113 30  
 info.nl@wiha.com  
 www.wiha.com/nl

**Wiha in Italia**

Thoelke Rappresentanze Srl  
 Phone +39-0332-966039  
 info.it@wiha.com  
 www.wiha.com/it

**Premium Tools Australia Pty Ltd.**

PO Box 63  
 Bargo, NSW 2574  
 Phone +61 02 4664 1460  
 Fax +61 02 8088 7272  
 sales@wiha.com.au  
 www.wiha.com.au

**Premium Tools (NZ) Ltd.**

Unit 5C 89 Ellice Road  
 Wairau Valley  
 Auckland, New Zealand  
 Phone +64 09 444 2560  
 Fax +64 09 355 0411  
 sales@wiha.co.nz  
 www.wiha.co.nz

**Robert Rieffel AG**

Widenholzstrasse 8  
 8304 Wallisellen/Switzerland  
 Phone +41 44 877 33 33  
 Fax +41 44 877 33 22  
 info@rieffel.ch  
 www.rieffel.ch

Technical modifications reserved!  
 Art.Nr. 99999487 | 1883-03/2019-3 | Printed in Germany | EN

EN

www.wiha.com

**wiha**   
 Tools that work for you

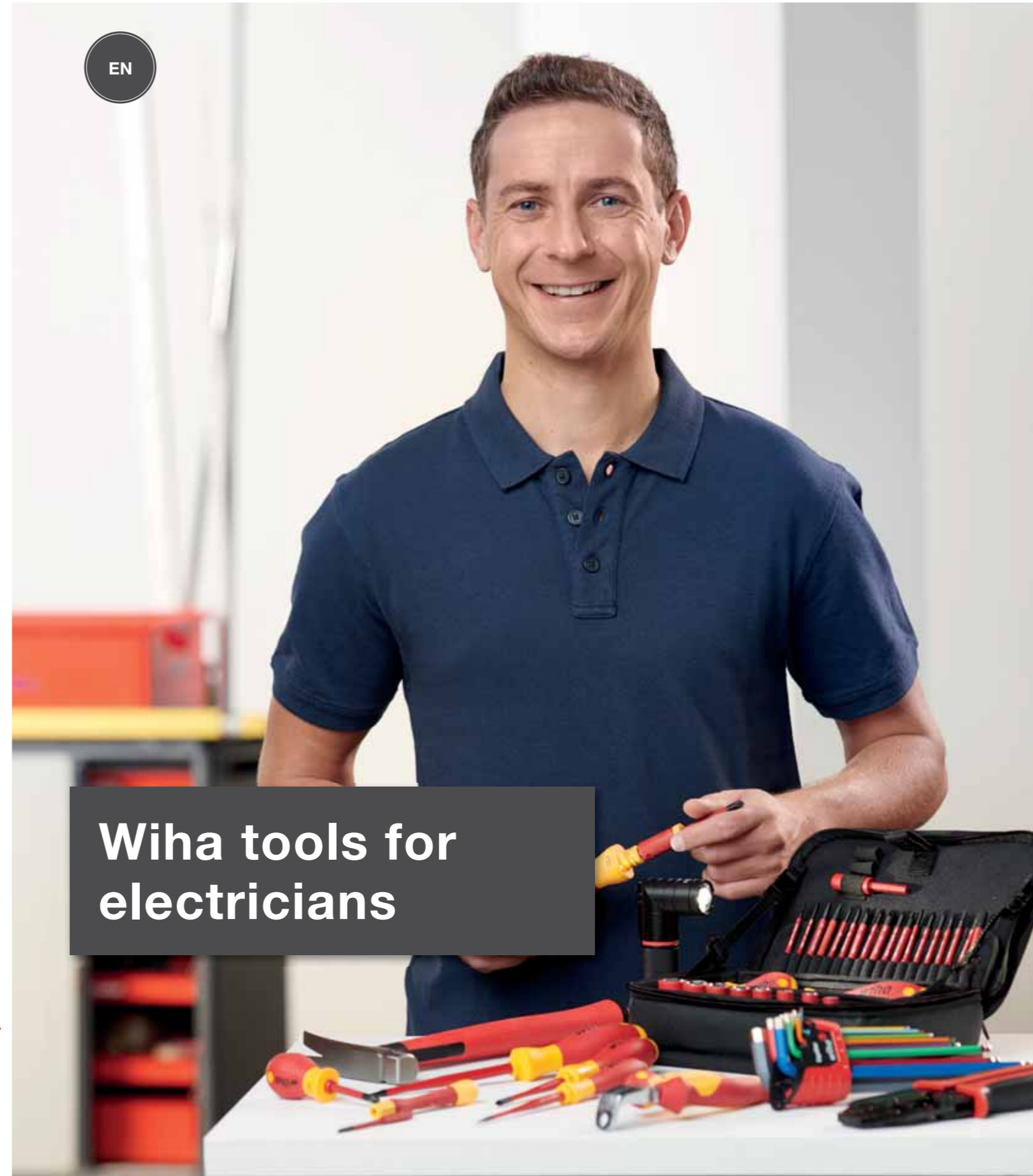

**Wiha tools for  
 electricians**

**wiha**   
 Tools that work for you

Wiha tools for electricians









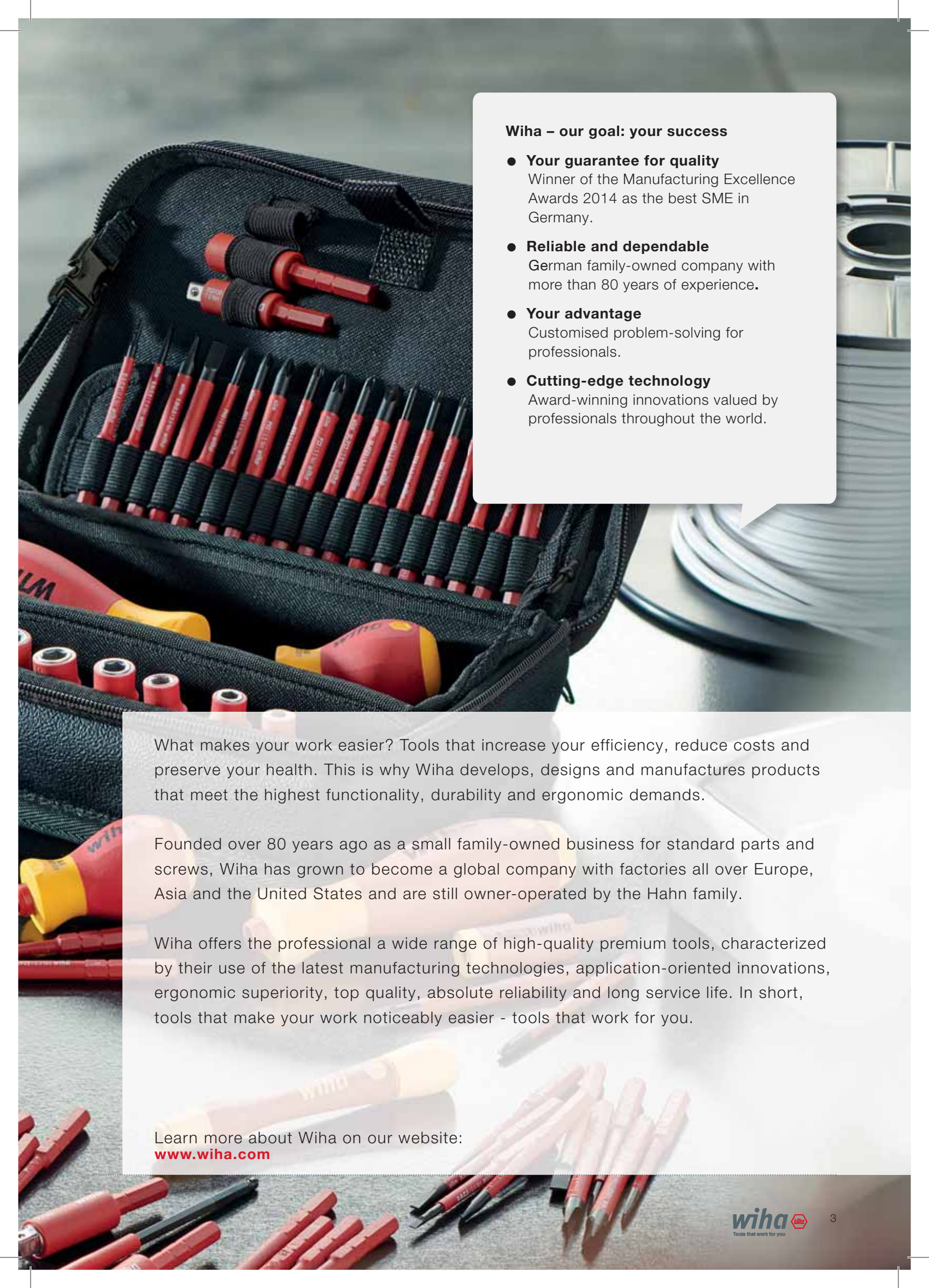

### Wiha – our goal: your success

- **Your guarantee for quality**  
Winner of the Manufacturing Excellence Awards 2014 as the best SME in Germany.
- **Reliable and dependable**  
German family-owned company with more than 80 years of experience.
- **Your advantage**  
Customised problem-solving for professionals.
- **Cutting-edge technology**  
Award-winning innovations valued by professionals throughout the world.

What makes your work easier? Tools that increase your efficiency, reduce costs and preserve your health. This is why Wiha develops, designs and manufactures products that meet the highest functionality, durability and ergonomic demands.

Founded over 80 years ago as a small family-owned business for standard parts and screws, Wiha has grown to become a global company with factories all over Europe, Asia and the United States and are still owner-operated by the Hahn family.

Wiha offers the professional a wide range of high-quality premium tools, characterized by their use of the latest manufacturing technologies, application-oriented innovations, ergonomic superiority, top quality, absolute reliability and long service life. In short, tools that make your work noticeably easier - tools that work for you.

Learn more about Wiha on our website:  
[www.wiha.com](http://www.wiha.com)



# VDE-insulated tools from Wiha

## To work safer, more efficiently and with less strain on the body.



### **Certified safety – from our own safety testing procedure according to IEC standards.**

**Voltage testing:** All Wiha VDE-tools, which have special markings, are individually tested at 10,000 V AC and are approved for 1,000 V AC and 1,500 V DC.

**Cold shock test:** Cooling down to -25° C. The skinning material must retain its toughness, so that it doesn't break when subjected to shock and knocks.

**Test of electrical skinning properties:** 24 hours storage in water, then 3 minutes test at 10,000 V AC. There must neither be flashover nor disruptive discharge.

**Test of the adhesion of the skinning material coating:** 168 hours storage at 70° C, then test of adhesion at 500 N.

**Pressure tests:** Test at 20 N pressure load, 70° C temperature and 5,000 V AC test voltage. No disruptive discharge may occur.

**Test of combustion behaviour:** The tools are subjected to a flame for 10 seconds. The skinning material must then extinguish and not continue to burn.

### **Safety note**

The following equipment is required for all work on or around live components and should be appropriate for the specific task

- insulating personal protective equipment
- insulating safety mechanisms
- insulated tools

Before starting work, you must disconnect all active, live components of electrical machines and equipment and ensure that they remain disconnected while you carry out the work.

This is achieved by complying with the five safety rules:

- disconnect
- secure against reconnection
- ensure power is switched off
- earth and short-circuit
- cover or block off adjacent live components



As an internationally recognized institute, the VDE is responsible for the testing and certification of electrotechnical products. Wiha provides the professional with a broad range of VDE products, developed and continuously optimized specifically for electricians, which also provide application-oriented solutions for everyday use.

The Wiha quality-management system according to ISO 9001:2015 ensures that only first-class products are manufactured – and that you can work with products of excellent quality. To ensure maximum safety for the user, the entire Wiha VDE range must undergo the most stringent inspections and individual tests. All Wiha VDE-tools hold multiple certifications: The VDE-GSmark stands for safety with regard to any risk, from electrical right up to radiological. Products labelled with a double triangle and a voltage range are suitable for work with live parts.

The international standard IEC 60900 defines the construction, safety as well as single, series, and random testing of insulated tools. But with Wiha you don't just work safer, but also healthier and more efficiently. Specially developed ergonomic geometries ensure comfortable handling that protects the body from strain. The result: easier work, less signs of fatigue, more efficiency.





# 83 professionnelle. Ét system. ElectricVario Family fra Wiha.

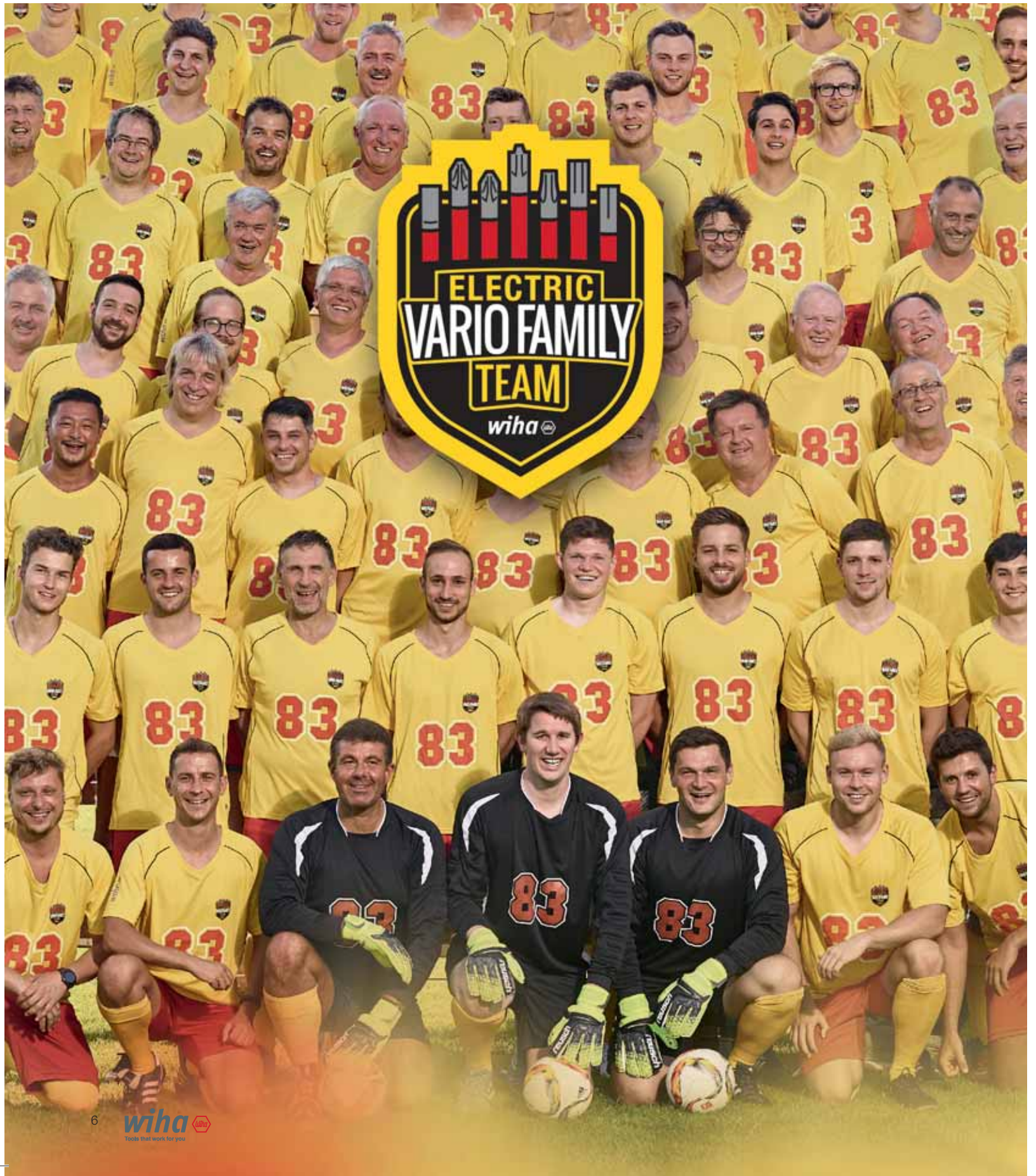



There has never been a team with so many exceptional players: the ElectricVario Family by Wiha unites all fastening tools that electricians need for all the challenges in their job. These include many new members to complete the team. The best thing about them: Thanks to the countless combination possibilities, the tools can be used flexibly and thus save valuable time and space. Combinable with one another, the tools also ensure safe screw-fastening on live parts thanks to their insulation. The ergonomically shaped screwdriver handles also help to protect the user's muscles. Professional users play in the Premier League when they use ElectricVario Family products. They can always be identified via the ElectricVario Family logo.

- **Increases your efficiency**  
Various usage options for all fastening procedures and application fields.
- **Provides you with full protection**  
Internationally award-winning VDE-insulated tools, each individually tested at 10,000 V AC and approved for use at 1,000 V AC.
- **Increases your safety**  
Wiha slimBits ensure unrestricted and fully insulated access to low-lying screws.

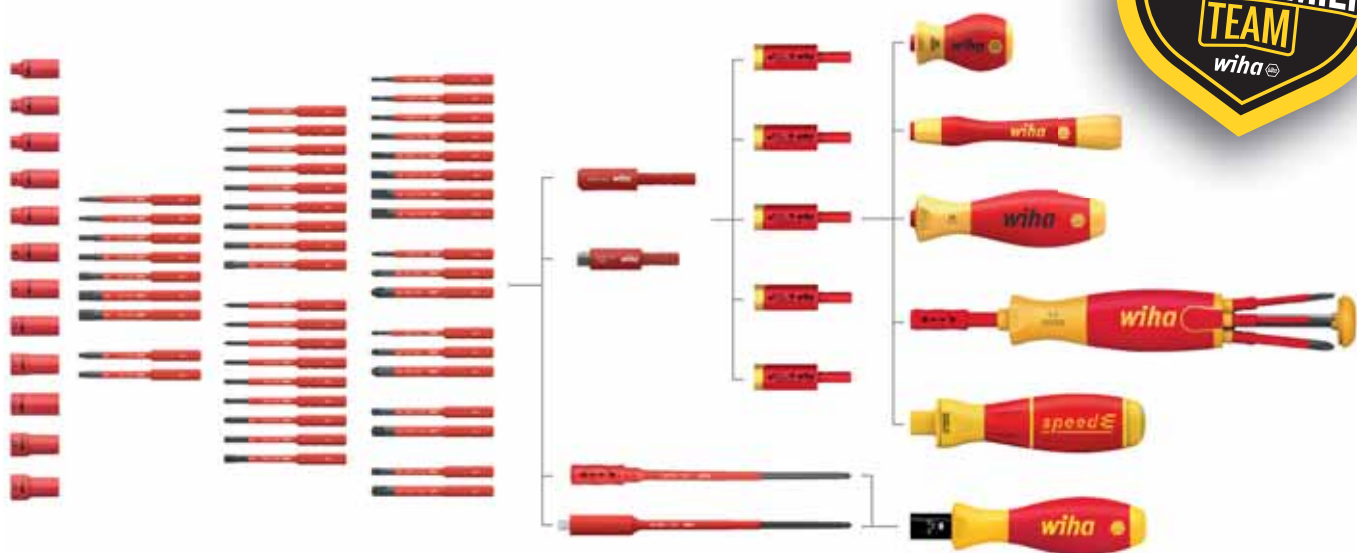
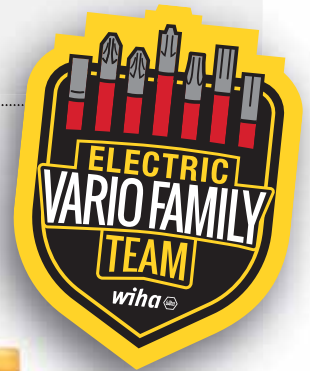

# Content

**Competence XXL II electrician's tool set**  
Page 14



**Tool set service technician**  
Page 18



**Tool set slimVario® electric**  
Page 19



**Tool set electrician**  
Page 21



**E-screwdriver, set 1, speedE®**  
Page 30



**easyTorque torque set electric adapter**  
Page 40



**Torque screwdriver with T-handle TorqueVario®-S T electric**  
Page 46



**Screwdriver with bit holder set SoftFinish® electric slimVario®**  
Page 54



**Torque screwdriver TorqueVario®-S electric**  
Page 36



**slimBit electric bit set**  
Page 41



**Screwdriver with bit magazine LiftUp electric**  
Page 50



**Fine screwdriver set PicoFinish® slimVario® electric**  
Page 55

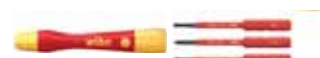

**BiCut® Professional electric high-performance diagonal cutters with DynamicJoint®**  
Page 100



**Heavy-duty diagonal cutters Professional electric with DynamicJoint®**  
Page 102



**Cable cutter Professional electric**  
Page 103



**Combination pliers Professional electric with DynamicJoint® and OptiGrip**  
Page 103



**Needle nose pliers Professional electric**  
Page 108



**High-leverage combination pliers Professional electric with DynamicJoint® and OptiGrip**  
Page 108



**Water pump pliers Professional electric**  
Page 108



**Water pump pliers Professional electric**  
Page 109



**Installation pliers TriCut Professional electric**  
Page 120



**Stripping diagonal cutters Professional electric with DynamicJoint®**  
Page 120



**Stripping pliers Professional electric**  
Page 120



**Needle nose pliers Inomic® VDE**  
Page 121



**Flashlight with LED, laser and UV light**  
Page 130



**Torque QuickCheck torque testing device**  
Page 131



**Voltage tester Volt Detector non-contact, single-pole, 230-1,000 VAC**  
Page 132



**Voltage tester SoftFinish® single-pole, 110-250 volts**  
Page 132





















**SoftFinish® dowel racket set with dowels**  
Page 138



**Electrician's hammer**  
Page 138





<p><b>Bit set for mounting</b> Page 22</p> 	<p><b>Ratchet wrench set insulated 1/2"</b> Page 23</p> 	<p><b>Single open-end spanner set, insulated 6-32 mm</b> Page 24</p> 	<p><b>Range of Applications</b> From page 10</p>	<p>Range of Applications</p>
<p><b>Screwdriver set SoftFinish® electric slimFix</b> Page 62</p>  <p><b>Screwdriver with LiftUp 25 magnetic bit magazine</b> Page 80</p> 	<p><b>Screwdriver with bit magazine magnetic</b> Page 80</p>  <p><b>BitBuddy® TY bit set, 29 mm</b> Page 84</p> 	<p><b>L-key set in ErgoStar holder</b> Page 92</p> 	<p><b>Fastening / jamming</b> From page 26</p>	<p>Fastening/ jamming</p>
<p><b>Precision mechanic's diagonal cutters Classic</b> Page 104</p> 	<p><b>Shear for electricians</b> Page 104</p> 	<p><b>Hacksaw electric</b> Page 104</p> 	<p><b>Trimming / cutting</b> From page 96</p>	<p>Trimming/ cutting</p>
<p><b>Long flat-nose pliers Professional electric</b> Page 109</p> 	<p><b>Pliers wrench Classic</b> Page 110</p> 	<p><b>Classic circlip pliers with MagicTips®, straight</b> Page 115</p> 	<p><b>Supplying / holding</b> From page 106</p>	<p>Supplying/ holding</p>
<p><b>Stripping tool</b> Page 121</p> 	<p><b>Stripping tool automatic</b> Page 122</p> 	<p><b>Automatic crimp tool</b> Page 123</p> 	<p><b>Stripping/ insulating / crimping</b> From page 116</p>	<p>Stripping/ insulating/ crimping</p>
<p><b>Electrician's Longlife® folding ruler, 2 m</b> Page 132</p> 	<p><b>Electrician's spirit level</b> Page 133</p> 	<p><b>Surveying/ marking/ measuring/ checking</b> From page 126</p>	<p>Surveying/ marking/ measuring/ checking</p>	
			<p><b>Striking/ chiselling</b> From page 134</p>	<p>Striking/ chiselling</p>





#### **Increases your efficiency**

A wide range of tools – so the right one is always to hand when you need it.

#### **Protects your health**

The patented and multiple award-winning Wiha SoftFinish® handle size concept prevents occupational illnesses as work is kind to hands and muscles. Recommended by German doctors and therapists from the AGR! (Healthy back association)

#### **Provides you with full protection**

Each tool individually tested at 10,000 V AC and approved for 1,000 V AC.

#### **Increases your safety**

Wiha slim tools ensure full and fully-insulated access to low-lying screws.



# The range. Cases that really deliver.

The professional often has reservations about conventional tool boxes: too inaccessible, little storage space, not robust enough. Deficiencies that Wiha has taken to heart – and eliminated – in the development of its case sets.

Wiha cases therefore combine many good qualities: Stable inline rollers allow easy and stress-free transportation of tools. The durable PP-plastic with reinforced plastic elements ensures a longlifespan. Gas-filled shock absorbers hold the cover in all positions and reduce the risk of injury when closing. Tool trays ensure quick and easy access to the tool, the case itself provides a lot of extra storage space for small items and machines. And, last but not least, you can easily access the right tool, whenever it is needed.

**"A case with all major Wiha tools and innovations - like Christmas for the electrician!"**  
Rolf Muschal





Your entire workshop - now you can take it with you!



Whether next door or at the most remote site: It's great if the tool you need is quickly at hand. Compact, handy and robust, the Wiha toolbox set ensures access to the tools you require, at any time and in any situation.

Specially compiled according to varying requirements and applications, the Wiha toolbox sets have one thing in common: All include high-quality tools in proven Wiha quality, guaranteeing easy and efficient working.

Ergonomic in design, durable in material and processing, and safe thanks to rigorous and extensive safety test procedures, Wiha tools prove to be a practical and indispensable companion for the electrician, especially in their toolbox set.

- **Increases your efficiency**

A wide range of tools – so the right one is always to hand when you need it.

- **Meets your requirements**

Robuust, groot, duurzaam en veilig met dekselhouder

- **Lowers your costs**

The correct torque avoids damaging material and no follow-up work is necessary.

- **Increases your safety**

Each tool individually tested at 10,000 V AC and approved for 1,000 V AC.







**Meets your requirements:** Case: robust, large, stable and secure with lid brake. **Lowers your costs:** The correct torque protects material from damage and ensures no additional follow-up work. **Increases your safety:** Internationally award-winning VDE-insulated tools, each individually tested at 10,000 V AC and approved for use at 1,000 V AC. Gas-filled shock absorbers hold the lid in all positions and reduce the risk of injury when closing. **Protects your health:** Wiha pliers require less force and reduce pressure on wrists. Ergonomic handle design makes work easier and prevents occupational illnesses. Trolley with stable in-line rollers allow easy and stress-free transportation of tools to the work area. **Increases your efficiency:** A comprehensive tool assortment, always providing you with the right tool when it is needed. The design and function of the tool trays guarantee quick and easy access to tools. **Increases your flexibility:** Ample space for additional tools and lots of storage for small parts and machines.

Order-No.



42069

1

**Fastening / jamming**

- ⊖ ⊕ ⊕ ⊕ Torque screwdriver set TorqueVario®-S electric (36791)  
1 x Torque screwdriver TorqueVario®-S electric Variable torque limit settings, Tool tested at 10,000 V AC / 1 x Adjusting tool for torque screwdriver with long handle / 1 x Adapter TorqueVario-S electric for slimBits  
1 x 2,5 / 1 x 3,5 / 1 x 5,5 / 1 x 6,5 / 1 x PH1 / 1 x PH2 / 1 x PZ1 PZ2 / 1 x SL/PZ1 / 1 x SL/PZ2 / 1 x T9 / 1 x T10 / 1 x T15 / 1 x T20 / 1 x T25
- Screwdriver with bit magazine LiftUp electric (41234) 1 x 2,5 / 1 x 3,5 / 1 x 5,5 / 1 x PZ1 PZ2 / 1 x SL/PZ2
- Screwdriver with bit holder SoftFinish® electric slimVario Stubby for slimBits, Tool tested at 10,000 V AC (41229)
- ⊕ slimBit electric bit Pozidriv, Tool tested at 10,000 V AC / PZ2 x 75 (34586)
- ⊖ Screwdriver SoftFinish® electric slimFix Slotted, Tool tested at 10,000 V AC / 3,5 x 100 (35446) / 5,5 x 125 (35391) / 6,5 x 150 (35392)
- ⊕ Screwdriver SoftFinish® electric slimFix Phillips, Tool tested at 10,000 V AC / PH1 x 80 (35393) / PH2 x 100 (35394)
- ⊕ Screwdriver SoftFinish® electric slimFix Pozidriv, Tool tested at 10,000 V AC / PZ1 x 80 (35395) / PZ2 x 100 (35396)
- ⊕ Screwdriver SoftFinish® electric slimFix PlusMinus/Pozidriv, Tool tested at 10,000 V AC / SL/PZ1 x 80 (36329) / SL/PZ2 x 100 (36330)
- ⊕ Screwdriver SoftFinish® electric slimFix TORX® Tamper Resistant (with hole), Tool tested at 10,000 V AC / T10H x 100 (41141) / T15H x 100 (41142) / T20H x 100 (41143) / T25H x 125 (41144)
- Screwdriver SoftFinish® electric Hex nut driver, Tool tested at 10,000 V AC / 5,5 x 125 (00856) / 7 x 125 (00858) / 8 x 125 (00859) / 10 x 125 (00861) / 13 x 125 (00864)
- ⊕ Fine screwdriver PicoFinish electric Phillips, Tool tested at 10,000 V AC / PH0 x 60 (38880)
- ⊖ Fine screwdriver PicoFinish electric Slotted, Tool tested at 10,000 V AC / 2,5 x 60 (38876)
- ⊖ ⊕ ⊖ ⊖ ⊖ Switch cabinet key pen shape in blister pack 5-8 x 9 (39076)
- ⊖ Screwdriver SoftFinish® Slotted with one-piece hexagonal blade and solid steel cap 3,5 x 75 (03223) / 12,0 x 200 (03231)
- ⊕ ⊕ ⊕ XLSelector Y bit set, 25 mm (41832) 1 x PH1 / 4 x PH2 / 1 x PH3 / 2 x PZ1 / 4 x PZ2 / 2 x PZ3 / 2 x T10 / 3 x T15 / 3 x T20 / 3 x T25 / 3 x T30 / 2 x T40 / 1 x Bit holder magnetic extra strong magnet, 1/4"
- L-key set in ErgoStar holder (41979) 1,5 / 2 / 2,5 / 3 / 4 / 5 / 6 / 8 / 10

**Trimming / cutting**

- ✂ Professional BiCut® high-performance diagonal cutters with DynamicJoint® Switchable, Tool tested at 10,000 V AC / 200mm, 8" (38191)
- ✂ Professional electric diagonal cutters with DynamicJoint®, Tool tested at 10,000 V AC / 160mm, 6 1/2" (26741)
- ✂ Cable cutter Professional electric, Tool tested at 10,000 V AC / 200mm, 8" (34744)
- ✂ Precision mechanic's diagonal cutters Classic with opening spring 125mm, 5" (36189)

**Supplying / holding**

- Combination pliers Professional electric with DynamicJoint® and OptiGrip with extra long cutting edge, Tool tested at 10,000 V AC / 180mm, 7" (26708)
- Needle nose pliers Professional electric with cutting edge curved shape, approx. 40°, Tool tested at 10,000 V AC / 200mm, 8" (26729)
- Needle nose pliers Professional electric with cutting edge straight shape, Tool tested at 10,000 V AC / 200mm, 8" (26727)
- Water pump pliers Professional electric with push button adjustment, Tool tested at 10,000 V AC / 250mm, 10" (37450)

**Stripping/ insulating / crimping**

- ✂ Installation pliers TriCut Professional electric 170mm, 7" (38552)
- Stripping tool with self-rotating trailing blade 165mm, 6 1/2" (35969)
- Stripping tool automatic up to 16 mm² in blister pack 200mm, 8" (42062)
- Automatic crimp tool for wire-end sleeves hex crimping 210mm, 0,08-16mm² (41246)
- Crimp tool for insulated cable eyes and contacts 220mm, 0,5-6mm² (33841)
- ✂ Shear for electricians with crimp function in blister pack 160mm, 50mm² (41923)

**Surveying/marketing/measuring/checking**

- Voltage tester Volt Detector non-contact, single-pole, 230-1,000 VAC (37871)
- ⊖ Voltage tester SoftFinish® single-pole, 110-250 volts Slotted transparent, with push-on clip (34745)
- Flashlight with LED, laser and UV light in blister pack, including 3 AAA batteries 100 / 310 lm x 390 - 400 nm (41286)
- Electrician's spirit level 40 cm (42074)
- Electrician's Longlife® folding ruler, 2 m metric, 10 segments (42068)
- ⊕ SoftFinish® dowel racket set with dowels (41289) 1 x Dowel racket Phillips / 2 x 30 / 2 x 40

**Striking/ chiselling**

- Electrician's hammer with 300 g hammer head, in blister pack 23,9 x 283 (42071)





**Meets your requirements:** Case: robust, large, stable and secure with lid brake. **Lowers your costs:** The right tool protects you from damaging materials and avoids subsequent work. **Increases your safety:** Internationally award-winning VDE-insulated tools, each individually tested at 10,000 V AC and approved for use at 1,000 V AC. Gas-filled shock absorbers hold the lid in all positions and reduce the risk of injury when closing. **Protects your health:** Wiha pliers require less force and reduce pressure on wrists. Ergonomic handle design makes work easier and prevents occupational illnesses. Carry belt enables the simple transport of the tool case and keeps hands free for other materials. **Increases your efficiency:** A comprehensive tool assortment, always having the right tool at hand when needed. The design and function of the tool trays guarantee quick and easy access to tools. **Increases your flexibility:** Ample space for additional tools and lots of storage for small parts and machines.

**assorted 80-pcs. in case**

9300-702

Order-No.



40523

1

**Fastening / jamming**

- Screwdriver SoftFinish® electric Hex nut driver, Tool tested at 10,000 V AC / 5,5 x 125 (00856) / 7 x 125 (00858) / 8 x 125 (00859) / 10 x 125 (00861)
- ⊖ Screwdriver SoftFinish® electric slimFix Slotted, Tool tested at 10,000 V AC / 3,5 x 100 (35446) / 4,0 x 100 (35390) / 5,5 x 125 (35391) / 6,5 x 150 (35392)
- ⊕ Screwdriver SoftFinish® electric slimFix electric PlusMinus/Phillips, Tool tested at 10,000 V AC / SL/PH1 x 80 (35502) / SL/PH2 x 100 (35503)
- ⊕ Screwdriver SoftFinish® electric slimFix PlusMinus/Pozidriv, Tool tested at 10,000 V AC / SL/PZ1 x 80 (36329) / SL/PZ2 x 100 (36330)
- ⊕ Screwdriver SoftFinish® electric slimFix Phillips, Tool tested at 10,000 V AC / PH1 x 80 (35393) / PH2 x 100 (35394)
- ⊕ Screwdriver SoftFinish® electric slimFix Pozidriv, Tool tested at 10,000 V AC / PZ1 x 80 (35395) / PZ2 x 100 (35396)
- ⊖ Screwdriver SoftFinish® Slotted with one-piece hexagonal blade and solid steel cap 12,0 x 200 (03231)
- ⊖ ⊕ ⊖ ⊖ ⊖ Switch cabinet key cross shape (36114)
- ⊖ ⊕ ⊕ Screwdriver with bit magazine LiftUp electric (38611) 1 x 3,0 /1 x 4,0 /1 x 5,5 /1 x PH1 /1 x PH2 /1 x SL/PZ2
- L-key set in Compact holder (01418) 1,5 / 2 / 2,5 / 3 / 4 / 5 / 6 / 8 / 10
- ⊖ ⊕ ⊕ ⊕ Bit set XLSelector Standard 25 mm (29417) 1 x 4,5 /1 x 5,5 /1 x 6,5 /2 x PH1 /4 x PH2 /1 x PH3 /2 x PZ1 /5 x PZ2 /1 x PZ3 /2 x T10 / 2 x T15 /2 x T20 /3 x T25 /2 x T30 /1 x T40 /1 x Bit holder magnetic, 58 mm 1/4"

**Trimming / cutting**

- ✂ Professional BiCut® high-performance diagonal cutters with DynamicJoint® Switchable, Tool tested at 10,000 V AC / 200mm, 8" (38191)
- ✂ Professional electric diagonal cutters with DynamicJoint®, Tool tested at 10,000 V AC / 180mm, 7" (26744)
- ✂ Precision mechanic's diagonal cutters Classic with opening spring 125mm, 5" (36189)

**Supplying / holding**

- Water pump pliers Professional electric with push button adjustment, Tool tested at 10,000 V AC / 250mm, 10" (37450)
- ⊖ Needle nose pliers Professional electric with cutting edge curved shape, approx. 40°, Tool tested at 10,000 V AC / 200mm, 8" (26729)
- Combination pliers Professional electric with DynamicJoint® and OptiGrip with extra long cutting edge, Tool tested at 10,000 V AC / 180mm, 7" (26708)
- ⊖ Needle nose pliers Professional electric with cutting edge straight shape, Tool tested at 10,000 V AC / 200mm, 8" (26727)

**Stripping/ insulating / crimping**

- ✂ Installation pliers TriCut Professional electric 170mm, 7" (38552)
- Stripping tool automatic up to 6 mm<sup>2</sup> in blister pack 190mm, 7 1/2" (36050)
- Stripping tool with self-rotating trailing blade 165mm, 6 1/2" (35969)
- Crimp tool for wire-end sleeves 220mm, 0,14-16mm<sup>2</sup> (33844)

**Surveying/marketing/measuring/checking**

- Voltage tester Volt Detector non-contact, single-pole, 230-1,000 VAC (37871)
- ⊖ Voltage tester SoftFinish® single-pole, 110-250 volts Slotted transparent, with push-on clip (34745)
- Folding ruler Longlife 2 m metric, 10 segments (27057)
- Switch cabinet spirit level 20 cm (36859)





**Meets your requirements:** Carefully selected tool ranges for the most common applications. **Increases your safety:** Wiha slim blades ensure unlimited, protected access to deep-set screws. Internationally award-winning VDE-insulated tools, each individually tested at 10,000 V AC and approved for use at 1,000 V AC. **Increases your efficiency:** Compact and space-saving tool range.

**assorted 29-pcs. in bag**

9300-030

Order-No.



37137

1

**Fastening / jamming**

- ⊖ Screwdriver SoftFinish® electric slimFix Slotted, Tool tested at 10,000 V AC / 3,5 x 100 (35446) / 5,5 x 125 (35391)
- ⊕ Screwdriver SoftFinish® electric slimFix Phillips, Tool tested at 10,000 V AC / PH1 x 80 (35393) / PH2 x 100 (35394)
- ⊕ Screwdriver SoftFinish® electric slimFix Pozidriv, Tool tested at 10,000 V AC / PZ1 x 80 (35395) / PZ2 x 100 (35396)
- ⊖ PicoFinish® fine screwdriver Slotted 1,5 x 40 (42384) / 2,0 x 40 (42388) / 2,5 x 50 (42391) / 3,0 x 50 (42394)
- ⊕ PicoFinish® fine screwdriver Phillips PH00 x 40 (42402) / PH0 x 50 (42401)
- ⊖ ⊕ ⊙ ⊚ Switch cabinet key cross shape (36114)
- L-key set in Compact holder (01418)  
1,5 / 2 / 2,5 / 3 / 4 / 5 / 6 / 8 / 10

**Trimming / cutting**

- ✂ Professional electric diagonal cutters with DynamicJoint®, Tool tested at 10,000 V AC / 160mm, 6 ½" (26741)
- ✂ Diagonal cutters Electronic wide, pointed head without bevelled edge 130mm, 5 ½" (26818)

**Supplying / holding**

- Needle nose pliers Professional electric with cutting edge straight shape, Tool tested at 10,000 V AC / 200mm, 8" (26727)
- Needle nose pliers Electronic narrow, short head straight form 150mm, 6" (26801)

**Stripping/ insulating / crimping**

- Stripping tool with self-rotating trailing blade 165mm, 6½" (35969)

**Surveying/marketing/measuring/checking**

- ⊖ Voltage tester SoftFinish® single-pole, 110-250 volts Slotted transparent, with push-on clip (34745)

Tool set slimVario® electric



**Simplifies your work:** All tools securely arranged in a robust, orderly bag. **Increases your safety:** Wiha slimBits ensure good, protected access to deep-set screws. **Increases your efficiency:** Space saved thanks to extensive interchangeable bit system and nut driver inserts. **Provides you with full protection:** Each tool individually tested at 10,000 V AC and approved for 1,000 V AC. **Protects your material:** Fully insulated nut driver reduces the risk of short circuits.

mixed, 31-pcs. in functional bag

7209N

Order-No.		1
43465		
⊖	2,0 x 75• / 3,5 x 75 / 5,5 x 75 / 6,5 x 75	
⊕	PH0 x 75• / PH1 x 75 / PH2 x 75	
⊗	SL/PZ1 x 75 / SL/PZ2 x 75	
⊕	PZ1 x 75 / PZ2 x 75	
○	5 x 42 / 5,5 x 42 / 6 x 42 / 7 x 42 / 8 x 42 / 10 x 42 / 11 x 42 / 13 x 42	
●	3 x 75 / 4 x 75 / 5 x 75	
⊕	T10 x 75• / T15 x 75 / T20 x 75 / T25 x 75	
	slimVario® electric adapter for 1/4" nut driver	
	slimVario® electric extension for slimBits	
	Screwdriver with bit holder SoftFinish® slimVario® electric	
	Fine screwdriver PicoFinish® slimVario® electric	
○	Screwdriver with bit holder SoftFinish® electric slimVario Stubby for slimBits	

• no slim version  
Manufactured acc. to IEC 60900.

Tool set electrician



**Protects your health:** With the patented SoftFinish® handle design, ensuring work is kind to hands and muscles. Recommended by doctors and therapists at German Campaign for Healthier Backs. **Increases your efficiency:** Compact and space-saving tool range. **Provides you with full protection:** Each tool individually tested at 10,000 V AC and approved for 1,000 V AC.

screwdriver, diagonal cutters, 6-pcs. in bag

9300-018

Order-No.		1
33969		
<b>Fastening / jamming</b>		
⊖	Screwdriver SoftFinish® electric Slotted, Tool tested at 10,000 V AC / 3,5 x 100 (00822) / 4,5 x 125 (00824) / 5,5 x 125 (00826)	
⊕	Screwdriver SoftFinish® electric Phillips, Tool tested at 10,000 V AC / PH1 x 80 (00847) / PH2 x 100 (00848)	
<b>Trimming / cutting</b>		
⚡	Professional electric diagonal cutters with DynamicJoint®, Tool tested at 10,000 V AC / 160mm, 6 1/2" (26741)	



Tool set electrician



**Increases your efficiency:** Compact and space-saving tool range.  
**Provides you with full protection:** Each tool individually tested at 10,000 V AC and approved for 1,000 V AC.

**screwdriver, needle nose pliers, diagonal cutters, 5-pcs. in bag**

9300

Order-No.



26755

1

**Fastening / jamming**

⊖ Screwdriver SoftFinish® electric Slotted, Tool tested at 10,000 V AC / 3,5 x 100 (00822) / 5,5 x 125 (00826)

⊕ Screwdriver SoftFinish® electric Phillips, Tool tested at 10,000 V AC / PH2 x 100 (00848)

**Trimming / cutting**

⚡ Professional electric diagonal cutters with DynamicJoint®, Tool tested at 10,000 V AC / 160mm, 6 1/2" (26741)

**Supplying / holding**

● Needle nose pliers Professional electric with cutting edge straight shape, Tool tested at 10,000 V AC / 200mm, 8" (26727)

Tool set electrician



**Meets your requirements:** Carefully selected tool ranges for the most common applications. **Increases your safety:** Internationally award-winning VDE-insulated tools, each individually tested at 10,000 V AC and approved for use at 1,000 V AC. **Protects your health:** With the patented SoftFinish® handle design, ensuring work is kind to hands and muscles. Recommended by doctors and therapists at German Campaign for Healthier Backs. **Increases your efficiency:** Compact and space-saving tool range.

**assorted 12-pcs. in bag**

9300-025

Order-No.



36389

1

**Fastening / jamming**

⊖ Screwdriver SoftFinish® electric slimFix Slotted, Tool tested at 10,000 V AC / 3,5 x 100 (35446) / 4,5 x 125 (35501) / 5,5 x 125 (35391)

⊕ Screwdriver SoftFinish® electric slimFix Pozidriv, Tool tested at 10,000 V AC / PZ1 x 80 (35395) / PZ2 x 100 (35396)

**Trimming / cutting**

⚡ Cable cutter Professional electric, Tool tested at 10,000 V AC / 200mm, 8" (34744)

**Supplying / holding**

● Needle nose pliers Professional electric with cutting edge straight shape, Tool tested at 10,000 V AC / 200mm, 8" (26727)

**Supplying / holding**

⚡ Heavy-duty diagonal cutters Professional electric with DynamicJoint® with switchable opening spring 180mm, 7" (41274)

**Stripping/ insulating / crimping**

Stripping tool automatic up to 6 mm² in blister pack 190mm, 7 1/2" (36050)

Stripping tool with self-rotating trailing blade 165mm, 6 1/2" (35969)

**Surveying/markings/measuring/checking**

⊖ Voltage tester SoftFinish® single-pole, 110-250 volts Slotted transparent, with push-on clip (34745)

Folding ruler Longlife 2 m metric, 10 segments (27057)

Tool set electrician



**Increases your safety:** Wiha slim blades ensure unlimited, protected access to deep-set screws. **Protects your health:** With the patented SoftFinish® handle design, ensuring work is kind to hands and muscles. Recommended by doctors and therapists at German Campaign for Healthier Backs. **Increases your efficiency:** Compact and space-saving tool range. **Provides you with full protection:** Each tool individually tested at 10,000 V AC and approved for 1,000 V AC.

**screwdriver, heavy-duty diagonal cutters, 7-pcs. in bag**

9300-031

Order-No.	
38020	1

**Fastening / jamming**

⊖	Screwdriver SoftFinish® electric slimFix Slotted, Tool tested at 10,000 V AC / 3,5 x 100 (35446) / 4,0 x 100 (35390) / 5,5 x 125 (35391)
⊕	Screwdriver SoftFinish® electric slimFix Phillips, Tool tested at 10,000 V AC / PH2 x 100 (35394)
⊕	Screwdriver SoftFinish® electric slimFix Pozidriv, Tool tested at 10,000 V AC / PZ2 x 100 (35396)
⊕	Screwdriver SoftFinish® electric slimFix PlusMinus/Pozidriv, Tool tested at 10,000 V AC / SL/PZ2 x 100 (36330)

**Supplying / holding**

	Heavy-duty diagonal cutters Professional electric with DynamicJoint® with switchable opening spring 160mm, 6,5" (40921)
--	---

Tool set electrician



**Simplifies your work:** Free hands and no damage to work trousers thanks to pouch attached to belt. **Increases your safety:** Wiha slim blades ensure unlimited, protected access to deep-set screws. Internationally award-winning VDE-insulated tools, each individually tested at 10,000 V AC and approved for use at 1,000 V AC. **Protects your health:** With the patented SoftFinish® handle design, ensuring work is kind to hands and muscles. Recommended by doctors and therapists at German Campaign for Healthier Backs. **Increases your efficiency:** All main tools quickly accessible, always at hand.

**assorted slotted, Phillips, 10-pcs. in belt pouch**

9300-012-01

Order-No.	
40948	1

**Fastening / jamming**

⊖	Screwdriver SoftFinish® electric slimFix Slotted, Tool tested at 10,000 V AC / 3,5 x 100 (35446) / 4,0 x 100 (35390) / 5,5 x 125 (35391)
⊕	Screwdriver SoftFinish® electric slimFix Phillips, Tool tested at 10,000 V AC / PH1 x 80 (35393) / PH2 x 100 (35394)

**Stripping/ insulating / crimping**

	Stripping pliers Professional electric 160mm, 6 1/2" (26847)
	Stripping tool with self-rotating trailing blade 165mm, 6 1/2" (35969)

**Supplying / holding**

●	Needle nose pliers Professional electric with cutting edge straight shape, Tool tested at 10,000 V AC / 200mm, 8" (26727)
---	---

**Surveying/marketing/measuring/checking**

⊖	Voltage tester SoftFinish® single-pole, 110-250 volts Slotted transparent, with push-on clip (34745)
	Measuring tape 5 m (33251)



**Tool set electrician**



**Simplifies your work:** Free hands and no damage to work trousers thanks to pouch attached to belt. **Increases your safety:** Wiha slim blades ensure unlimited, protected access to deep-set screws. Internationally award-winning VDE-insulated tools, each individually tested at 10,000 V AC and approved for use at 1,000 V AC. **Protects your health:** With the patented SoftFinish® handle design, ensuring work is kind to hands and muscles. Recommended by doctors and therapists at German Campaign for Healthier Backs. **Increases your efficiency:** All main tools quickly accessible, always at hand.

**assorted slotted, Pozidriv, 10-pcs. in belt pouch** 9300-013-02

Order-No.  1  
40282

**Fastening / jamming**

⊖ Screwdriver SoftFinish® electric slimFix Slotted, Tool tested at 10,000 V AC / 3,5 x 100 (35446) / 4,0 x 100 (35390) / 5,5 x 125 (35391)

⊕ Screwdriver SoftFinish® electric slimFix Pozidriv, Tool tested at 10,000 V AC / PZ1 x 80 (35395) / PZ2 x 100 (35396)

**Stripping/ insulating / crimping**

⊞ Stripping pliers Professional electric 160mm, 6 1/2" (26847)

Stripping tool with self-rotating trailing blade 165mm, 6 1/2" (35969)

**Supplying / holding**

● Needle nose pliers Professional electric with cutting edge straight shape, Tool tested at 10,000 V AC / 200mm, 8" (26727)

**Surveying/markings/measuring/checking**

⊖ Voltage tester SoftFinish® single-pole, 110-250 volts Slotted transparent, with push-on clip (34745)

Measuring tape 5 m (33251)

**Bit set for mounting**



**Simplifies your work:** Utmost accessibility thanks to long, 70 mm bits. Also ideal for machine operation. **Facilitates handling:** Variably adjustable blade length depending on application. **Increases your efficiency:** All common blades in one compact set.

**19-pcs. in bag** 79187 T04

Order-No.  1  
41223

⊕ 1 x T15 / 1 x T20 / 1 x T25 / 1 x T30 / 1 x T40

⊕ 1 x PH0 / 1 x PH1 / 1 x PH2

⊕ 1 x SL/PZ1 / 1 x SL/PZ2

⊖ 1 x 3,5 / 1 x 4,0 / 1 x 5,5

● 1 x 4,0 / 1 x 5,0 / 1 x 6,0

○ 1 x Bit holder magnetic, 74 mm 1/4"

○ 1 x Screwdriver handle SoftFinish®-telescopic for SYSTEM 6 interchangeable blade

○ 1 x Bit holder SYSTEM 6 clamping with ball

**Ratchet wrench set insulated 1/2"**



**Increases your efficiency:** Various usage options for all fastening procedures and application fields. **Improved access:** Deep-set screws can be reached easily. **Provides you with full protection:** Each tool individually tested at 10,000 V AC and approved for 1,000 V AC. **Increases your flexibility:** Adjustable right or left rotation through switching lever. **Protects your material:** Fully insulated tool reduces the risk of short circuits.

**Ratchet wrench set insulated 3/8"**



**Increases your efficiency:** Various usage options for all fastening procedures and application fields. **Improved access:** Deep-set screws can be reached easily. **Provides you with full protection:** Each tool individually tested at 10,000 V AC and approved for 1,000 V AC. **Increases your flexibility:** Adjustable right or left rotation through switching lever. **Protects your material:** Fully insulated tool reduces the risk of short circuits.

**20-pcs. in case** 7208N K2001

Order-No.	
43024	1
T-handle insulated for nut driver (43063)	
Ratchet wrench insulated for nut drivers Switchable 1/2" x 250 mm	
<input type="radio"/>	Insulated extension 1/2" square adapter for nut driver inserts, insulated 1/2" x 250 mm / 1/2" x 125 mm
<input type="radio"/>	Insulated nut driver insert 1/2" hexagon head 10 / 11 / 12 / 13 / 14 / 17 / 19 / 22 / 24 / 27 / 32
<input checked="" type="radio"/>	Insulated nut driver insert 1/2" internal hexagon 4 x 120 mm / 5 x 120 mm / 6 x 120 mm / 8 x 120 mm / 10 x 120 mm

Manufactured according to EN/IEC 60900.

**20-pcs. in case** 7207N K2001

Order-No.	
43023	1
T-handle insulated for nut driver (43062)	
Ratchet wrench insulated for nut drivers Switchable 3/8" x 200 mm	
<input type="radio"/>	Insulated extension 3/8" square adapter for nut driver inserts, insulated 3/8" x 125 mm / 3/8" x 250 mm
<input type="radio"/>	Insulated nut driver insert 3/8" hexagon head 8 / 10 / 11 / 12 / 13 / 14 / 16 / 17 / 18 / 19 / 21 / 22
<input checked="" type="radio"/>	Insulated nut driver insert 3/8" internal hexagon 4 x 75 mm / 5 x 75 mm / 6 x 75 mm / 8 x 75 mm

Manufactured according to EN/IEC 60900.



Single open-end spanner set, insulated 6-32 mm



**Increases your efficiency:** Improved accessibility to restricted spaces thanks to 15° jaw positioning. **Provides you with full protection:** Each tool individually tested at 10,000 V AC and approved for 1,000 V AC. **Protects your material:** Fully insulated tool reduces the risk of short circuits.

20-pcs. in case

5590N T20

Order-No.



43022

1

Single, insulated open-end spanner

6 x 90 mm / 7 x 90 mm / 8 x 100 mm / 9 x 100 mm /  
 10 x 110 mm / 11 x 110 mm / 12 x 130 mm / 13 x 135 mm /  
 14 x 145 mm / 15 x 150 mm / 16 x 160 mm / 17 x 160 mm /  
 18 x 175 mm / 19 x 175 mm / 22 x 195 mm / 24 x 225 mm /  
 27 x 250 mm / 30 x 290 mm / 32 x 310 mm

○

Adjustable spanner electric Adjustable between 0-30 mm  
 0 - 30 x 250 mm

○

Manufactured according to EN/IEC 60900.







**Increases your efficiency**

Wiha screwdrivers offer an optimal balance between power and control thanks to their unique handle size concept.

**Saves money**

By using the correct torque value, torque tools protect against material damage and reworking.

**Protects your health**

The patented and multiple award-winning Wiha SoftFinish® handle size concept prevents occupational illnesses as work is kind to hands and muscles. Recommended by German doctors and therapists from the AGR! (Healthy back association)

**Provides you with full protection**

Each tool individually tested at 10,000 V AC and approved for 1,000 V AC.

**Increases your safety**

Wiha slim tools ensure full and fully-insulated access to low-lying screws.

## Fastening / jamming

We have the know-how at the tip of our fingers.

The ergonomic quality of a tool is never quite so apparent as when fastening and clamping. Under the motto "A grasp on turning" Wiha presents an innovative handle size concept which breaks new ground in terms of individual user comfort.

Many commonly available screwdrivers are not designed to meet the needs of users. This results in disadvantages in guiding the tool as well as in transmitting force while fastening. In contrast, the Wiha SoftFinish® concept works with four different handle sizes: Thus, each handle has a perfectly correlated ratio of guidance, speed and torque for any task.

The Wiha slimTECHNOLOGY offers additional comfort, permitting unrestricted access to each screw with 33 % slimmer blades.

The speedE® e-screwdriver proves itself to be the ideal tool for virtually every screw-fastening task. Whether handling delicate fastenings, long screws or an extremely large number of screws, professionals can do their job faster while working with the e-screwdriver.

**"Thanks to the speedE®, I maintain complete control of the tightening force since the electrical-assisted screw-driving stops automatically at 0.4 Nm. Overtightened screws and defective controls are a thing of the past."**

Simon Furrer, WorldSkills 2017 World Champion in Abu Dhabi, Industrial Control Category





Globally  
unique

*speed* 

## The first e-screwdriver from Wiha.

### The e-bike among screwdrivers:

- Increases your speed
- Protects your material
- Provides you with full protection
- Protects your health
- Increases your control

**speedE®:**  
Fasten screws faster electrically –  
tighten carefully by hand.

[www.wiha.com/speedE](http://www.wiha.com/speedE)

### speedE®: 3 steps in 1 move

1



**Increases your speed**  
Work completed twice as fast  
thanks to a 3-step process.

2



**Protects your material**  
Electric screw fastening with a protection  
function to prevent damage to materials  
(max. 0.4 Nm).

3



**Increases your control**  
Fixing by hand with a deft touch.

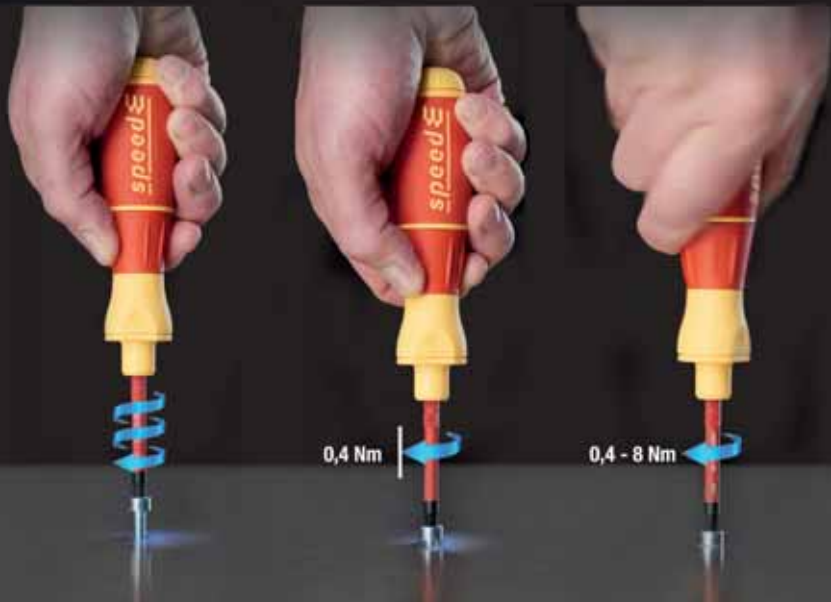

Anyone who spends much of the day fastening screws knows how much time it takes and the considerable strain it causes to wrists for long periods of time. With the world's first e-screwdriver speedE® by Wiha, such problems become a thing of the past once and for all. With the speedE®, you fasten screws twice as fast as with a conventional screwdriver and still have full control over the tightening force thanks to the material protection function. On reaching 0.4 Nm, power-assisted fastening switches off automatically to protect the material and users can finish fastening carefully by hand. Thanks to its electric ratchet function and award-winning SoftFinish handle shape, the speedE® noticeably reduces strain on joints, tendons and muscles. It is recommended by German doctors and therapists at German Campaign for Healthier Backs for this very reason. The integrated LED light shines directly onto the screw and work piece that the user is working on. The e-screwdriver improves everyday efficiency, particularly due to its compact design. At least 800 screws can be fastened with its standard 18500 batteries when charged. It can also handle numerous different screw profiles when used in combination with Wiha slimBits. In combination with the VDE certified slimBits the speedE® offers electricians full protection during their daily work.

- **Protects your material**  
Electric screw fastening with a protection function to prevent damage to materials (max. 0.4 Nm).
- **Increases your speed**  
Work completed twice as fast thanks to a 3-step process.
- **Increases your control**  
Fixing by hand with a deft touch.
- **Protects your health**  
Recommended by doctors and therapists at German Campaign for Healthier Backs.
- **Provides you with full protection**  
slimBits tested at 10,000 V AC and approved for 1,000 V AC.





E-screwdriver, set 1, speedE®



**Protects your health:** Recommended by doctors and therapists at German Campaign for Healthier Backs. **Increases your control:** Fixing by hand with a deft touch. **Provides you with full protection:** slimBits tested at 10,000 V AC and approved for 1,000 V AC. **Increases your speed:** Work completed twice as fast thanks to a 3-step process. **Protects your material:** Electric screw fastening with a protection function to prevent damage to materials (max. 0.4 Nm).



Slotted, Phillips, PlusMinus/Pozidriv, 10 pcs in L Boxx Mini with slimBits, batteries and EU charger

590 T101

Order-No.



41911

1

**Fastening / jamming**

	E-screwdriver handle speedE®
⊖	slimBit electric bit Slotted 3,5 x 75 (41159) / 5,5 x 75 (34581)
⊕	slimBit electric bit Phillips PH1 x 75 (34583) / PH2 x 75 (34584)
⊕	slimBit electric bit PlusMinus/Pozidriv SL/PZ1 x 75 (34589) / SL/PZ2 x 75 (34590)
	Battery set, 18500 Li-ion 2 units in box (41914)
	Charger for 18500 Li-ion batteries with USB and Europlug (41915)

E-screwdriver, set 2, speedE®



**Protects your health:** Recommended by doctors and therapists at German Campaign for Healthier Backs. **Increases your control:** Fixing by hand with a deft touch. **Provides you with full protection:** slimBits tested at 10,000 V AC and approved for 1,000 V AC. **Increases your speed:** Work completed twice as fast thanks to a 3-step process. **Protects your material:** Electric screw fastening with a protection function to prevent damage to materials (max. 0.4 Nm).



Mixed 13 pcs in L Boxx Mini with slimBits, easyTorque adapter, batteries and EU charger

590 T102

Order-No.



41912

1

**Fastening / jamming**

	E-screwdriver handle speedE®
⊖	slimBit electric bit Slotted 3,5 x 75 (41159) / 5,5 x 75 (34581)
⊕	slimBit electric bit Phillips PH1 x 75 (34583) / PH2 x 75 (34584)
⊕	slimBit electric bit Pozidriv PZ1 x 75 (34585) / PZ2 x 75 (34586)
⊕	slimBit electric bit PlusMinus/Pozidriv SL/PZ1 x 75 (34589) / SL/PZ2 x 75 (34590)
	easyTorque electric torque adapter for slimBits and slimVario® holder in blister 2,8 Nm ±10 % (41344)
	Battery set, 18500 Li-ion 2 units in box (41914)
	Charger for 18500 Li-ion batteries with USB and Europlug (41915)

E-screwdriver, set 3, speedE®



**Protects your health:** Recommended by doctors and therapists at German Campaign for Healthier Backs. **Increases your control:** Fixing by hand with a deft touch. **Provides you with full protection:** slimBits tested at 10,000 V AC and approved for 1,000 V AC. **Increases your speed:** Work completed twice as fast thanks to a 3-step process. **Protects your material:** Electric screw fastening with a protection function to prevent damage to materials (max. 0.4 Nm).



Mixed 25 pcs in L Boxx Mini with slimBits, easyTorque adapters, batteries and EU charger

590 T103

Order-No.

41913



1

Fastening / jamming

- E-screwdriver handle speedE®
- ⊖ slimBit electric bit Slotted 3,5 x 75 (41159) / 5,5 x 75 (34581)
- ⊕ slimBit electric bit Phillips PH1 x 75 (34583) / PH2 x 75 (34584)
- ⊕ slimBit electric bit Pozidriv PZ1 x 75 (34585) / PZ2 x 75 (34586)
- ⊕ slimBit electric bit PlusMinus/Pozidriv SL/PZ1 x 75 (34589) / SL/PZ2 x 75 (34590)
- ⊗ slimBit electric bit TORX® T10• x 75 (35507) / T15 x 75 (35508) / T20 x 75 (35509) / T25 x 75 (36071)
- slimBit electric bit Hex 3 x 75 (37147) / 4 x 75 (37225) / 5 x 75 (37226) / 6 x 75 (37227)
- easyTorque electric torque adapter for slimBits and slimVario® holder in blister 0,8 Nm ±10 % (41341) / 2,0 Nm ±10 % (41342) / 2,5 Nm ±10 % (41343) / 2,8 Nm ±10 % (41344) / 4,0 Nm ±10 % (41345)
- Battery set, 18500 Li-ion 2 units in box (41914)
- Charger for 18500 Li-ion batteries with USB and Europlug (41915)

• no slim version

Battery set, 18500 Li-ion



2 units in box

5991

Order-No.

41914



6

Charger for 18500 Li-ion batteries



with USB and Europlug

5992

Order-No.

41915



1

INFOBOX: Wiha speedE®



E-screwdriver speedE®

Power-assisted screw-driving halves working time.

- Thanks to the integrated material protection function, the electric assistance stops automatically at 0.4 Nm.
- Final screw tightening can then be carried out by hand.
- Recommended by doctors and therapists.
- slimBits tested at 10,000 V AC and approved for 1,000 V AC.



There are moments when you need to control your power.



Power is good. Controlled power is better. The fully certified Wiha VDE torque screwdriver systems TorqueVario®-S and TorqueVario®-S TR combine precision with safety: With a distinctly audible and perceptible click signal when the torque value is reached. With a release accuracy of  $\pm 6\%$  of the set scale value, Wiha VDE screwdrivers meet the accuracy requirements of EN ISO 6789. Uncompromising safety is ensured in production and testing according to IEC 60900, VDE/GS certification and individual product testing at 10,000 V AC.

- **Increases your efficiency**  
Using the correct torque prevents from rework and damaged material.
- **Lowers your costs**  
The correct torque protects you from warranty claims.
- **Provides you with full protection**  
Each tool individually tested at 10,000 V AC and approved for 1,000 V AC.
- **Increases your safety**  
Wiha slimBits grant unhindered, fully insulated access to deeplying screws.





**Meets your requirements:** A variably settable torque covers a large application area. **Simplifies your work:** All tools securely arranged in a robust, orderly bag. **Lowers your costs:** The correct torque protects you from warranty claims. **Increases your safety:** Wiha slimBits ensure good, protected access to deep-set screws. **Protects your health:** With the patented SoftFinish® handle design, ensuring work is kind to hands and muscles. Recommended by doctors and therapists at German Campaign for Healthier Backs. **Increases your efficiency:** The correct torque avoids damaging material and no follow-up work is necessary. **Provides you with full protection:** Each tool individually tested at 10,000 V AC and approved for 1,000 V AC.

**assorted, variably adjustable torque limit, 18-pcs. in bag**

2872 T18

Order-No.



36791

1

- 1 x Torque screwdriver TorqueVario®-S electric Variable torque limit settings / 0,8 - 5 Nm
- 1 x Adjusting tool for torque screwdriver with long handle
- 1 x Adapter TorqueVario-S electric for slimBits
- ⊖ 1 x 2,5 • / 1 x 3,5 / 1 x 5,5 / 1 x 6,5
- ⊕ 1 x PH1 / 1 x PH2
- ⊕ 1 x PZ1 / 1 x PZ2
- ⊕ 1 x SL/PZ1 / 1 x SL/PZ2
- ⊕ 1 x T9 • / 1 x T10 • / 1 x T15 / 1 x T20 / 1 x T25

• no slim version

Manufactured acc. to IEC 60900. DIN EN ISO 6789.





**Meets your requirements:** A variably settable torque covers a large application area. **Simplifies your work:** All tools securely arranged in a robust, orderly bag. **Lowers your costs:** The correct torque protects you from warranty claims. **Increases your safety:** Wiha slimBits ensure good, protected access to deep-set screws. **Protects your health:** With the patented SoftFinish® handle design, ensuring work is kind to hands and muscles. Recommended by doctors and therapists at German Campaign for Healthier Backs. **Increases your efficiency:** The correct torque avoids damaging material and no follow-up work is necessary. **Provides you with full protection:** Each tool individually tested at 10,000 V AC and approved for 1,000 V AC.

#### assorted, variably adjustable torque limit, 13-pcs. in bag

2872 T13

Order-No.



40674

1

- 1 x Torque screwdriver TorqueVario®-S electric Variable torque limit settings / 0,8 - 5 Nm
- 1 x Adjusting tool for torque screwdriver with long handle
- 1 x Screwdriver with bit holder SoftFinish® electric slimVario for slimBits
- 1 x Adapter TorqueVario-S electric for slimBits
- ⊖ 1 x 2,5• / 1 x 3,5 / 1 x 5,5
- ⊕ 1 x PH1 / 1 x PH2
- ⊕ 1 x PZ1 / 1 x PZ2
- ⊕ 1 x SL/PZ1 / 1 x SL/PZ2

• no slim version

Manufactured acc. to IEC 60900. DIN EN ISO 6789.

TorqueVario®-S electric nut driver insert 1/4" set



**Simplifies your work:** All tools securely arranged in a robust, orderly bag. **Provides you with full protection:** Each tool individually tested at 10,000 V AC and approved for 1,000 V AC. **Increases your flexibility:** Nut driver inserts can be used with speedE®, slimVario® and TorqueVario®-S tools thanks to the enclosed adapters. **Protects your material:** Fully insulated nut driver reduces the risk of short circuits.

Mixed, 10-pcs., with adapters in folding bag

7209N

Order-No.



43466

1

- 1 x slimVario® electric adapter for 1/4" nut driver
- 1 x Adapter TorqueVario-S electric for 1/4" nut driver
- 1 x 5 / 1 x 5,5 / 1 x 6 / 1 x 7 / 1 x 8 / 1 x 10 / 1 x 11 / 1 x 13

Torque screwdriver set TorqueVario®-S electric



**Lowers your costs:** The correct torque protects you from warranty claims. **Increases your safety:** Wiha slimBits ensure good, protected access to deep-set screws. **Increases your efficiency:** The correct torque avoids damaging material and no follow-up work is necessary. **Provides you with full protection:** Each tool individually tested at 10,000 V AC and approved for 1,000 V AC.

PlusMinus/Pozidriv variably settable torque limit 5-pcs.

2872 S3

Order-No.



38074

1

- 1 x Torque screwdriver TorqueVario®-S electric Variable torque limit settings / 0,8 - 5 Nm
- 1 x Adjusting tool for torque screwdriver with long handle
- 1 x Adapter TorqueVario-S electric for slimBits
- 1 x SL/PZ1 / 1 x SL/PZ2

Manufactured acc. to IEC 60900, DIN EN ISO 6789.



Fastening/jamming

**Meets your requirements:** A variably settable torque covers a large application area. **Lowers your costs:** The correct torque protects you from warranty claims. **Protects your health:** With the patented SoftFinish® handle design, ensuring work is kind to hands and muscles. Recommended by doctors and therapists at German Campaign for Healthier Backs. **Increases your efficiency:** The correct torque avoids damaging material and no follow-up work is necessary. **Provides you with full protection:** Each tool individually tested at 10,000 V AC and approved for 1,000 V AC.

○ Variable torque limit settings

2872

Order-No.	Nm	±%	Ø	→	↑	
26625	0,5-2,0	6 %	3,8	131	30	1
26626	0,8-5,0	6 %	3,8	138	36	1
26627	2,0-7,0	6 %	3,8	142	41	1

Manufactured acc. to IEC 60900, DIN EN ISO 6789.

Adjusting tool



for torque screwdriver with long handle

2859

Order-No.	←→ mm	↔	
26864	146	90	1





**Increases your efficiency**

Fast, easy checking of your torque tool thanks to mobile, compact shape.

**Increases your safety**

Checking your torque tool regularly guarantees safe, precise work with the correct torque.

**Saves time**

LED traffic light system displays results in a way which is quick and easy to understand.



Fastening/Jamming



**Increases your safety:** Checking your torque tool regularly guarantees safe, precise work with the correct torque. **Saves time:** LED traffic light system displays results in a way which is quick and easy to understand. **Increases your efficiency:** Fast, easy checking of your torque tool thanks to mobile, compact shape.

with adapter blades and batteries in box

2909

Order-No.	Nm	±%	SB
42086	2,8	2	x



### INFOBOX: Torque QuickCheck



#### Wiha Torque QuickCheck

- The Wiha torque screwdriver can quickly and easily test torque screwdrivers to check the precision of the configured torque value before each use.
- Checking tools regularly ensures reliable, precise work.
- The device offers user-friendly operation, clear test readings and easy to understand LED traffic light signals.
- Thanks to a compact, handy shape, it is the ideal companion when out on jobs.
- Suitable for all Torque Vario®-S and iTorque® torque screwdrivers whose torque range included 2.8 Nm.

easyTorque torque set electric adapter



**Lowers your costs:** The correct torque protects you from warranty claims. **Increases your efficiency:** The correct torque avoids damaging material and no follow-up work is necessary. Fully compatible with the Wiha slimBit system. **Provides you with full protection:** Each tool individually tested at 10,000 V AC and approved for 1,000 V AC.

with slimVario® holder and SL/PZ slimBits, 4-pcs. in blister pack

29701 080 S4

Order-No.	
41476	1
1 x 0,8 Nm	
1 x SL/PZ1 / 1 x SL/PZ2	
1 x SoftFinish® electric screwdriver handle	

Manufactured acc. to IEC 60900.

with slimVario® holder and SL/PZ slimBits, 4-pcs. in blister pack

29701 200 S4

Order-No.	
41477	1
1 x 2,0 Nm	
1 x SL/PZ1 / 1 x SL/PZ2	
1 x SoftFinish® electric screwdriver handle	

Manufactured acc. to IEC 60900.

with slimVario® holder and SL/PZ slimBits, 4-pcs. in blister pack

29701 280 S4

Order-No.	
41478	1
1 x 2,8 Nm	
1 x SL/PZ1 / 1 x SL/PZ2	
1 x SoftFinish® electric screwdriver handle	

Manufactured acc. to IEC 60900.

easyTorque torque set electric adapter



**Lowers your costs:** The correct torque protects you from warranty claims. **Increases your efficiency:** The correct torque avoids damaging material and no follow-up work is necessary. Fully compatible with the Wiha slimBit system. **Provides you with full protection:** Each tool individually tested at 10,000 V AC and approved for 1,000 V AC.

for slimBits and slimVario® holder, 5-pcs. in blister pack

29701 S5

Order-No.	
41479	1
1 x 0,8 Nm / 1 x 2,0 Nm / 1 x 2,5 Nm / 1 x 2,8 Nm / 1 x 4,0 Nm	

Manufactured acc. to IEC 60900.

easyTorque electric torque adapter



**Lowers your costs:** Torque tool extension for LiftUp and slimVario® screwdriver sets. The correct torque protects you from warranty claims. **Increases your efficiency:** The correct torque avoids damaging material and no follow-up work is necessary. Fully compatible with the Wiha slimBit system. **Provides you with full protection:** Each tool individually tested at 10,000 V AC and approved for 1,000 V AC.

for slimBits and slimVario® holder in blister

2970

Order-No.	Nm	±%	↔	↕	
41341	0,8	10 %	59	5,5	1
41342	2,0	10 %	59	5,5	1
41343	2,5	10 %	59	5,5	1
41344	2,8	10 %	59	5,5	1
41345	4,0	10 %	59	5,5	1

Manufactured acc. to IEC 60900.







Fastening/Jamming







**Increases your safety:** Wiha slimBits ensure good, protected access to deep-set screws. **Facilitates handling:** Compact slimBit box with easy access and an optimal view of profiles. Convenient safe storage of 12 slimBits – easily taken directly from the belt. **Facilitates handling:** Compact slimBit box with easy access and an optimal view of profiles. Convenient safe storage of 12 slimBits – easily taken directly from the belt. **Provides you with full protection:** Each tool individually tested at 10,000 V AC and approved for 1,000 V AC.

**TORX®, TORX PLUS®, 12-pcs. in SlimBit box** 2831

Order-No.	
43161	6
 1 x 6IP• / 1 x 7IP• / 1 x 8IP• / 1 x 9IP• / 1 x 10IP• / 1 x 15IP	
 1 x T6• / 1 x T7• / 1 x T8• / 1 x T9• / 1 x T10• / 1 x T15	
1 x slimBit box leer 2 Stk. mit Gürtelhalter	

• no slim version  
Manufactured acc. to IEC 60900.

**Slotted, Phillips, Pozidriv, PlusMinus/Pozidriv, TORX® 12-pcs. in SlimBit box** 2831

Order-No.	
43162	6
 1 x 3,5 / 1 x 5,5	
 1 x PH1 / 1 x PH2	
 1 x SL/PZ1 / 1 x SL/PZ2	
 1 x PZ1 / 1 x PZ2	
 1 x T10• / 1 x T15 / 1 x T20 / 1 x T25	
1 x slimBit box leer 2 Stk. mit Gürtelhalter	

• no slim version  
Manufactured acc. to IEC 60900.

**INFOBOX:  
slimBit box**

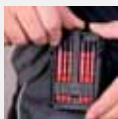

**slimBit box**

- Compact slimBit box with easy access and an optimal view of profiles.
- Suitable for storing Wiha slimBits. Ideal for mobile use.
- Wiha slimBits ensure unrestricted and fully insulated access to low-lying screws.
- Each tool individually tested at 10,000 V AC and approved for 1,000 V AC.





**Increases your safety:** Wiha slimBits ensure good, protected access to deep-set screws. **Facilitates handling:** Compact slimBit box with easy access and an optimal view of profiles. **Provides you with full protection:** Each tool individually tested at 10,000 V AC and approved for 1,000 V AC.

**Slotted, 6-pcs. in SlimBit box**

2831

Order-No.  6  
43152

⊖ 1 x 2,0• / 1 x 2,5• / 1 x 3,5 / 1 x 4,0 / 1 x 5,5 / 1 x 6,5

• no slim version  
Manufactured acc. to IEC 60900.

**Slotted, Pozidriv 6-pcs. in SlimBit box**

2831

Order-No.  6  
43157

⊖ 1 x 2,5• / 1 x 3,5 / 1 x 5,5 / 1 x 6,5

⊕ 1 x PZ1 / 1 x PZ2

• no slim version  
Manufactured acc. to IEC 60900.

**TORX®, 6-pcs. in SlimBit box**

2831

Order-No.  6  
43153

⊕ 1 x T8• / 1 x T9• / 1 x T10• / 1 x T15 / 1 x T20 / 1 x T25

• no slim version  
Manufactured acc. to IEC 60900.

**Slotted, PlusMinus/Pozidriv 6-pcs. in SlimBit box**

2831

Order-No.  6  
43158

⊖ 1 x 2,5• / 1 x 3,5 / 1 x 5,5 / 1 x 6,5

⊕ 1 x SL/PZ1 / 1 x SL/PZ2

• no slim version  
Manufactured acc. to IEC 60900.

**TORX®, 6-pcs. in SlimBit box**

2831

Order-No.  6  
43154

⊕ 1 x T6• / 1 x T7• / 1 x T8• / 1 x T9• / 1 x T10• / 1 x T15

• no slim version  
Manufactured acc. to IEC 60900.

**Slotted, Phillips 6-pcs. in SlimBit box**

2831

Order-No.  6  
43159

⊖ 1 x 2,5• / 1 x 3,5 / 1 x 5,5 / 1 x 6,5

⊕ 1 x PH1 / 1 x PH2

• no slim version  
Manufactured acc. to IEC 60900.

**TORX PLUS®, 6-pcs. in SlimBit box**

2831

Order-No.  6  
43155

⊕ 1 x 6IP• / 1 x 7IP• / 1 x 8IP• / 1 x 9IP• / 1 x 10IP• / 1 x 15IP

• no slim version  
Manufactured acc. to IEC 60900.

**Slotted, Phillips, Pozidriv 6-pcs. in SlimBit box**

2831

Order-No.  6  
43160

⊖ 1 x 2,0• / 1 x 2,5•

⊕ 1 x PH0• / 1 x PH1

⊕ 1 x PZ0• / 1 x PZ1

• no slim version  
Manufactured acc. to IEC 60900.

**Hex, 6-pcs. in SlimBit box**

2831

Order-No.  6  
43156

⦿ 1 x 2• / 1 x 2,5 / 1 x 3 / 1 x 4 / 1 x 5 / 1 x 6

• no slim version  
Manufactured acc. to IEC 60900.



**Increases your safety:** Wiha slimBits ensure good, protected access to deep-set screws. **Increases your efficiency:** Extensive interchangeable blade system saves you space. **Provides you with full protection:** Each tool individually tested at 10,000 V AC and approved for 1,000 V AC.

Fastening/Jamming

**Slotted** 283110

Order-No.	mm	mm	mm	max. Nm	
43114	1,5	75	0,4	6.0	0,4
43115	2,0	75	0,4	6.0	0,4
34578	2,5	75	0,4	6.0	0,4
34579	3,0	75	0,5	6.0	0,6
41159	3,5	75	0,6	6.0	1,4
34580	4,0	75	0,8	6.0	2,5
34581	5,5	75	1,0	6.0	3,8
34582	6,5	75	1,2	6.0	5,5

• no slim version  
Manufactured acc. to IEC 60900.

**Phillips** 283111

Order-No.	mm	mm	max. Nm	
43116	PH0	75	6,0	0,4
34583	PH1	75	6,0	3,8
34584	PH2	75	6,0	5,5

• no slim version  
Manufactured acc. to IEC 60900.

**Pozidriv** 283112

Order-No.	mm	mm	max. Nm	
43117	PZ0	75	6,0	0,5
34585	PZ1	75	6,0	3,8
34586	PZ2	75	6,0	5,5

• no slim version  
Manufactured acc. to IEC 60900.

**PlusMinus/Phillips** 283113

Order-No.	mm	mm	max. Nm	
34587	SL/PH1	75	6,0	3,8
34588	SL/PH2	75	6,0	5,5

Manufactured acc. to IEC 60900.

**PlusMinus/Pozidriv** 283114

Order-No.	mm	mm	max. Nm	
34589	SL/PZ1	75	6,0	3,8
34590	SL/PZ2	75	6,0	5,5

Manufactured acc. to IEC 60900.

**TORX®** 283115

Order-No.	mm	mm	max. Nm	
43140	T5	75	6,0	0,4
43141	T6	75	6,0	0,4
43142	T7	75	6,0	0,4
35506	T8	75	6,0	1,3
41160	T9	75	6,0	1,3
35507	T10	75	6,0	3,8
35508	T15	75	6,0	5,0
35509	T20	75	6,0	5,5
36071	T25	75	6,0	5,5

• no slim version  
Manufactured acc. to IEC 60900.

**TORX PLUS®** 283116

Order-No.	mm	mm	max. Nm	
43143	5IP	75	6	0,5
43144	6IP	75	6	0,8
43145	7IP	75	6	1,3
43146	8IP	75	6	2,0
43147	9IP	75	6	3,0
43148	10IP	75	6	4,5
43149	15IP	75	6	5,5
43150	20IP	75	6	5,5
43151	25IP	75	6	5,5

• no slim version  
Manufactured acc. to IEC 60900.

**Square** 283117

Order-No.	mm	mm	max. Nm	
35510	#1	2,3	75	6,0
35511	#2	2,8	75	6,0

Manufactured acc. to IEC 60900.

**Hex** 283118

Order-No.	mm	mm	max. Nm	
37222	1,5	75	6,0	0,9
37223	2	75	6,0	1,8
37224	2,5	75	6,0	3,8
37147	3	75	6,0	5,5
37225	4	75	6,0	5,5
37226	5	75	6,0	5,5
37227	6	75	6,0	5,5

• no slim version. Manufactured acc. to IEC 60900.



Adapter TorqueVario-S electric



**Increases your efficiency:** Fully compatible with the Wiha slimBit system. **Provides you with full protection:** Each tool individually tested at 10,000 V AC and approved for 1,000 V AC.

for slimBits

28799

Order-No.			mm		
35870	6	3,8	170	13	10

Manufactured acc. to IEC 60900.

Adapter TorqueVario-S electric



**Increases your efficiency:** Adapter allows users to fasten with a nut driver and TorqueVario®-S electric. **Provides you with full protection:** Each tool individually tested at 10,000 V AC and approved for 1,000 V AC.

for 1/4" nut driver

28799

Order-No.			mm		
43128	1/4"	3,8	178	12	10

Manufactured acc. to IEC 60900.

Insulated nut driver insert



Insulated nut driver insert



**Provides you with full protection:** Each tool individually tested at 10,000 V AC and approved for 1,000 V AC. **Protects your material:** Fully insulated tool reduces the risk of short circuits.

**Provides you with full protection:** Each tool individually tested at 10,000 V AC and approved for 1,000 V AC. **Protects your material:** Fully insulated tool reduces the risk of short circuits.

○ 1/4" hexagon head

7209NS

Order-No.	⌀	mm	
43088	4	42	1
43089	5	42	1
43090	5,5	42	1
43091	6	42	1
43092	7	42	1
43093	8	42	1
43094	9	42	1
43095	10	42	1
43096	11	42	1
43097	12	42	1
43098	13	42	1
43099	14	42	1

Manufactured according to EN/IEC 60900.

○ 1/2" hexagon head

7208NS

Order-No.	⌀	mm	
43077	10	55	1
43078	11	55	1
43079	12	55	1
43080	13	55	1
43081	14	55	1
43082	17	55	1
43083	19	55	1
43084	22	55	1
43085	24	55	1
43086	27	55	1
43087	32	55	1

Manufactured according to EN/IEC 60900.

Fastening/jamming

## Torque screwdriver with T-handle TorqueVario®-S T electric



**Meets your requirements:** A variably settable torque covers a large application area. **Lowers your costs:** The correct torque protects you from warranty claims. **Facilitates handling:** Effortless and comfortable transmission of high torques thanks to T-handle with ComfortGrip. **Increases your efficiency:** The correct torque avoids damaging material and no follow-up work is necessary. **Provides you with full protection:** Torque blades tested at 10,000 V AC and approved for 1,000 V AC.

### Variable torque limit settings

2933

Order-No.	Nm	±%	○	⚙️	⚙️	📦
43177	5-14	6	6	56	120	1

Manufactured acc. to IEC 60900. DIN EN ISO 6789.

## Interchangeable electric blade



**Increases your safety:** Wiha slim interchangeable blades ensure unlimited and fully-insulated access to low-lying screws. **Increases your efficiency:** Extensive interchangeable blade system saves you space. **Provides you with full protection:** Each tool individually tested at 10,000 V AC and approved for 1,000 V AC.

### TORX® for torque screwdriver with T-handle electric

283795

Order-No.	⚙️	mm	➔	max. Nm	📦
38931	T15	136	35	5,5	10
38932	T20	136	35	10	10
38933	T25	136	35	15	10
38934	T27	136	35	15	10
38935	T30	136	35	20	10
38936	T40	136	35	20	10

Manufactured acc. to IEC 60900.

### Hex for torque screwdriver with T-handle electric

283793

Order-No.	⚙️	mm	➔	max. Nm	📦
38918	3,0	136	35	5,5	10
38919	4,0	136	35	15	10
38920	5,0	136	35	20	10
38921	6,0	136	35	20	10

Manufactured acc. to IEC 60900.

## INFOBOX: Torque T-handle TorqueVario®-S T electric



### Torque T-handle TorqueVario®-S T electric

- For controlled fastening in a large range of applications.
- Torque value is continuously adjustable thanks to the adjusting tool.
- More fastening power thanks to T-handle design.
- Each tool individually tested at 10,000 V AC and approved for 1,000 V AC.
- Certified individual item testing directly after on-site production.
- Broad selection of interchangeable blades



Interchangeable electric blade



**Increases your efficiency:** Extensive interchangeable blade system saves you space. **Provides you with full protection:** Each tool individually tested at 10,000 V AC and approved for 1,000 V AC.

Hex nut driver for torque screwdriver with T-handle electric

283794

Order-No.	Ø	mm	max. Nm	
38925	7,0	136	5	10
38926	8,0	136	10	10
38927	9,0	136	14	10
38928	10,0	136	17	10
38929	13,0	136	20	10
38930	17,0	136	20	10

Manufactured acc. to IEC 60900.

Adjusting tool



for torque screwdriver with T-handle

2899

Order-No.	mm	mm	
28691	90	146	1

Fastening/jamming



All bits in the handle, always and everywhere.



Why make things complicated, when they can be compact? The practical Wiha LiftUp electric magazine bit holder accommodates up to six common insulated slimBits - and is therefore the ideal portable companion for every electrician. The bit magazine is unlocked at the touch of a button on the two rockers, and the slimBits can easily be removed and re-inserted. A reliably locked magazine prevents anything from being lost when on the move. The rotating cap is used to make working easier: Additional axial force can be exerted by pressing strongly with the hand against the cap, while rotating around the longitudinal axis with the other hand. Uncompromising safety is ensured in production and testing according to IEC 60900, VDE/GS certification and individual part testing at 10,000 V AC.

The Wiha magazine bit holder LiftUp electric is available in two content variants (SL/PH or SL/PH/PlusMinus PZ)

- **Increases your efficiency**

Wiha LiftUp electric, saves 75 % volume and 50 % less weight for 100 % efficiency.

- **Protects your health**

No risk of injury, all blades stowed safely inside the handle.

- **Provides you with full protection**

Each tool individually tested at 10,000 V AC and approved for 1,000 V AC.

- **Increases your safety**

Wiha slimBits grant unhindered, fully insulated access to deep lying screws.







**Increases your safety:** Wiha slimBits ensure good, protected access to deep-set screws. **Protects your health:** No risk of injury, all blades stowed safely inside the handle. **Increases your efficiency:** Wiha LiftUp electric saves 75% volume and 50% less weight for 100 % efficiency. **Provides you with full protection:** Each tool individually tested at 10,000 V AC and approved for 1,000 V AC.



**Slotted, Phillips with 6 slimBits**

2831 09 020

Order-No.



38610

5

⊖ 1 x 2,5• / 1 x 3,0 / 1 x 4,0 / 1 x 5,5

⊕ 1 x PH1 / 1 x PH2

• no slim version

Manufactured acc. to IEC 60900.

**Pozidriv, PlusMinus/Pozidriv, slotted with 6 slimBits**

2831 09 023

Order-No.



41234

5

⊖ 1 x 2,5• / 1 x 3,5 / 1 x 5,5

⊕ 1 x PZ1 / 1 x PZ2

⊕ 1 x SL/PZ2

• no slim version

Manufactured acc. to IEC 60900.



Fastening/jamming

**Simplifies your work:** All tools securely arranged in a robust, orderly bag. **Increases your safety:** Wiha slimBits ensure good, protected access to deep-set screws. **Increases your efficiency:** Extensive interchangeable blade system saves you space. **Provides you with full protection:** Each tool individually tested at 10,000 V AC and approved for 1,000 V AC.

**assorted 18-pcs. in bag**

2831 T18

Order-No.



41231

1

- 1 x Screwdriver with bit holder SoftFinish® electric slimVario Stubby for slimBits
- 1 x Screwdriver with bit holder SoftFinish® electric slimVario for slimBits
- ⊖ 1 x 2,5• / 1 x 3,5 / 1 x 5,5
- ⊕ 1 x PH1 / 1 x PH2
- ⊗ 1 x PZ1 / 1 x PZ2
- ⊗ 1 x SL/PZ1 / 1 x SL/PZ2
- ⊗ 1 x T9• / 1 x T10• / 1 x T15 / 1 x T20
- 1 x 3 / 1 x 4 / 1 x 5

• no slim version  
 Manufactured acc. to IEC 60900.



**Simplifies your work:** All tools securely arranged in a robust, orderly bag. **Increases your safety:** Wiha slimBits ensure good, protected access to deep-set screws. **Increases your efficiency:** Extensive interchangeable blade system saves you space. **Provides you with full protection:** Each tool individually tested at 10,000 V AC and approved for 1,000 V AC.

**Slotted, Phillips, Pozidriv, 9-pcs. in bag**

2831 T9 01

Order-No.



41232

1

- 1 x Screwdriver with bit holder SoftFinish® electric slimVario Stubby for slimBits
- 1 x Screwdriver with bit holder SoftFinish® electric slimVario for slimBits
- ⊖ 1 x 2,5• / 1 x 3,5 / 1 x 5,5
- ⊕ 1 x PH1 / 1 x PH2
- ⊕ 1 x PZ1 / 1 x PZ2

• no slim version  
Manufactured acc. to IEC 60900.

**Slotted, Pozidriv, PlusMinus/Pozidriv, 9-pcs. in bag**

2831 T9 02

Order-No.



41233

1

- 1 x Screwdriver with bit holder SoftFinish® electric slimVario Stubby for slimBits
- 1 x Screwdriver with bit holder SoftFinish® electric slimVario for slimBits
- ⊖ 1 x 2,5• / 1 x 3,5 / 1 x 5,5
- ⊕ 1 x PZ1 / 1 x PZ2
- ⊕ 1 x SL/PZ1 / 1 x SL/PZ2

• no slim version  
Manufactured acc. to IEC 60900.





Fastening/Jamming

**Simplifies your work:** All tools securely arranged in a robust, orderly bag. **Increases your safety:** Wiha slimBits ensure good, protected access to deep-set screws. **Provides you with full protection:** Each tool individually tested at 10,000 V AC and approved for 1,000 V AC. **Protects your material:** Fully insulated nut driver reduces the risk of short circuits.

**mixed, 13-pcs. in folding bag**

7209N

Order-No.



43467

1

1 x SoftFinish® electric screwdriver handle for slimBits

1 x slimVario® electric extension for slimBits

1 x slimVario® electric adapter for 1/4" nut driver

⊖ 1 x 3,5 / 1 x 5,5

⊙ 1 x 5 / 1 x 5,5 / 1 x 6 / 1 x 7 / 1 x 8 / 1 x 10 / 1 x 11 / 1 x 13

Manufactured acc. to IEC 60900.

Screwdriver with bit holder set SoftFinish® slimVario® electric



**Increases your safety:** Wiha slimBits ensure good, protected access to deep-set screws. **Protects your health:** With the patented SoftFinish® handle design, ensuring work is kind to hands and muscles. Recommended by doctors and therapists at German Campaign for Healthier Backs. **Provides you with full protection:** Each tool individually tested at 10,000 V AC and approved for 1,000 V AC.

4-pcs. with slimBits

2831-03

Order-No.



43449

5

1 x Screwdriver with bit holder SoftFinish® slimVario® electric for slimBits

⊖ 1 x 5,5

⊕ 1 x SL/PZ1 / 1 x SL/PZ2

Manufactured acc. to IEC 60900.

Screwdriver with bit holder set SoftFinish® electric slimVario®



**Simplifies your work:** Compact handle – maximum power. **Increases your safety:** Wiha slimBits ensure good, protected access to deep-set screws. Protected work in constricted spaces. **Increases your efficiency:** Fully compatible with the Wiha slimBit system. **Provides you with full protection:** Each tool individually tested at 10,000 V AC and approved for 1,000 V AC.

Stubby, 4-pcs.

SB 2831 0101

Order-No.



41230

1

○ Screwdriver with bit holder SoftFinish® electric slimVario Stubby for slimBits

⊖ 3,5 x 75

⊕ PH2 x 75

⊕ SL/PZ2 x 75

Manufactured acc. to IEC 60900.



**Increases your safety:** Wiha slimBits ensure good, protected access to deep-set screws. **Increases your efficiency:** Fully compatible with the Wiha slimBit system. **Provides you with full protection:** Each tool individually tested at 10,000 V AC and approved for 1,000 V AC. **Increases your precision:** Sensitive working and controlled power transmission thanks to the slim handle with a soft grip. Particularly suitable for use with slimBit profiles.

**4-pcs. with slimBits**

2831

Order-No.



43167

5

1 x Fine screwdriver PicoFinish® slimVario® electric for slimBits

⊖ 1 x 2,0•

⊕ 1 x PH0•

⊕ 1 x PZ0•

• no slim version

Manufactured acc. to IEC 60900.

INFOBOX:  
**slimTECHNOLOGY**

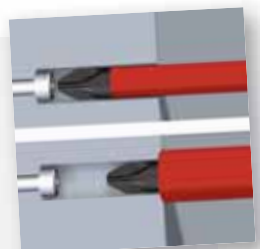

**Wiha SoftFinish® electric slimFix**

- Unlimited access.
- Blades up to 33 % narrower due to integrated insulation.
- Tool for spring clips (wedge-profiled output geometry).





**Increases your safety:** Wiha slimBits ensure good, protected access to deep-set screws. **Facilitates handling:** Compact slimBit box with easy access and an optimal view of profiles. Convenient safe storage of 12 slimBits – easily taken directly from the belt. **Facilitates handling:** Compact slimBit box with easy access and an optimal view of profiles. Convenient safe storage of 12 slimBits – easily taken directly from the belt. **Provides you with full protection:** Each tool individually tested at 10,000 V AC and approved for 1,000 V AC.

**TORX®, TORX PLUS®, 12-pcs. in SlimBit box**

2831

Order-No.



43161

6

- 1 x 6IP• / 1 x 7IP• / 1 x 8IP• / 1 x 9IP• / 1 x 10IP• / 1 x 15IP
- 1 x T6• / 1 x T7• / 1 x T8• / 1 x T9• / 1 x T10• / 1 x T15
- 1 x slimBit box leer 2 Stk. mit Gürtelhalter

• no slim version  
Manufactured acc. to IEC 60900.

**Slotted, Phillips, Pozidriv, PlusMinus/Pozidriv, TORX® 12-pcs. in SlimBit box**

2831

Order-No.



43162

6

- ⊖ 1 x 3,5 / 1 x 5,5
- ⊕ 1 x PH1 / 1 x PH2
- ⊕ 1 x PZ1 / 1 x PZ2
- ⊕ 1 x SL/PZ1 / 1 x SL/PZ2
- ⊕ 1 x T10• / 1 x T15 / 1 x T20 / 1 x T25
- 1 x slimBit box leer 2 Stk. mit Gürtelhalter

• no slim version  
Manufactured acc. to IEC 60900.

**INFOBOX:  
slimBit box**

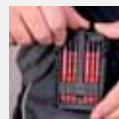

**slimBit box**

- Compact slimBit box with easy access and an optimal view of profiles.
- Suitable for storing Wiha slimBits. Ideal for mobile use.
- Wiha slimBits ensure unrestricted and fully insulated access to low-lying screws.
- Each tool individually tested at 10,000 V AC and approved for 1,000 V AC.







**Increases your safety:** Wiha slimBits ensure good, protected access to deep-set screws. **Facilitates handling:** Compact slimBit box with easy access and an optimal view of profiles. **Provides you with full protection:** Each tool individually tested at 10,000 V AC and approved for 1,000 V AC.



**Slotted, 6-pcs. in SlimBit box**

2831

Order-No.  6  
 43152  6  
 ⊖ 1 x 2,0• / 1 x 2,5• / 1 x 3,5 / 1 x 4,0 / 1 x 5,5 / 1 x 6,5  
 • no slim version  
 Manufactured acc. to IEC 60900.



**TORX®, 6-pcs. in SlimBit box**

2831

Order-No.  6  
 43153  6  
 ⊕ 1 x T8• / 1 x T9• / 1 x T10• / 1 x T15 / 1 x T20 / 1 x T25  
 • no slim version  
 Manufactured acc. to IEC 60900.



**TORX®, 6-pcs. in SlimBit box**

2831

Order-No.  6  
 43154  6  
 ⊕ 1 x T6• / 1 x T7• / 1 x T8• / 1 x T9• / 1 x T10• / 1 x T15  
 • no slim version  
 Manufactured acc. to IEC 60900.



**TORX PLUS®, 6-pcs. in SlimBit box**

2831

Order-No.  6  
 43155  6  
 ⊕ 1 x 6IP• / 1 x 7IP• / 1 x 8IP• / 1 x 9IP• / 1 x 10IP• / 1 x 15IP  
 • no slim version  
 Manufactured acc. to IEC 60900.



**Hex, 6-pcs. in SlimBit box**

2831

Order-No.  6  
 43156  6  
 ● 1 x 2• / 1 x 2,5 / 1 x 3 / 1 x 4 / 1 x 5 / 1 x 6  
 • no slim version  
 Manufactured acc. to IEC 60900.



**Slotted, Pozidriv 6-pcs. in SlimBit box**

2831

Order-No.  6  
 43157  6  
 ⊖ 1 x 2,5• / 1 x 3,5 / 1 x 5,5 / 1 x 6,5  
 ⊕ 1 x PZ1 / 1 x PZ2  
 • no slim version  
 Manufactured acc. to IEC 60900.



**Slotted, PlusMinus/Pozidriv 6-pcs. in SlimBit box**

2831

Order-No.  6  
 43158  6  
 ⊖ 1 x 2,5• / 1 x 3,5 / 1 x 5,5 / 1 x 6,5  
 ⊕ 1 x SL/PZ1 / 1 x SL/PZ2  
 • no slim version  
 Manufactured acc. to IEC 60900.



**Slotted, Phillips 6-pcs. in SlimBit box**

2831

Order-No.  6  
 43159  6  
 ⊖ 1 x 2,5• / 1 x 3,5 / 1 x 5,5 / 1 x 6,5  
 ⊕ 1 x PH1 / 1 x PH2  
 • no slim version  
 Manufactured acc. to IEC 60900.

**Slotted, Phillips, Pozidriv 6-pcs. in SlimBit box**

2831

Order-No.  6  
 43160  6  
 ⊖ 1 x 2,0• / 1 x 2,5•  
 ⊕ 1 x PH0• / 1 x PH1  
 ⊕ 1 x PZ0• / 1 x PZ1  
 • no slim version  
 Manufactured acc. to IEC 60900.



**Increases your safety:** Wiha slimBits ensure good, protected access to deep-set screws. **Increases your efficiency:** Extensive interchangeable blade system saves you space. **Provides you with full protection:** Each tool individually tested at 10,000 V AC and approved for 1,000 V AC.

**Slotted**

283110

Order-No.	mm	mm	mm	max. Nm		
43114	1,5	75	0,4	6.0	0,4	5
43115	2,0	75	0,4	6.0	0,4	5
34578	2,5	75	0,4	6.0	0,4	5
34579	3,0	75	0,5	6.0	0,6	5
41159	3,5	75	0,6	6.0	1,4	5
34580	4,0	75	0,8	6.0	2,5	5
34581	5,5	75	1,0	6.0	3,8	5
34582	6,5	75	1,2	6.0	5,5	5

• no slim version  
Manufactured acc. to IEC 60900.

**Phillips**

283111

Order-No.	mm	mm	max. Nm		
43116	PH0	75	6,0	0,4	5
34583	PH1	75	6,0	3,8	5
34584	PH2	75	6,0	5,5	5

• no slim version  
Manufactured acc. to IEC 60900.

**Pozidriv**

283112

Order-No.	mm	mm	max. Nm		
43117	PZ0	75	6,0	0,5	5
34585	PZ1	75	6,0	3,8	5
34586	PZ2	75	6,0	5,5	5

• no slim version  
Manufactured acc. to IEC 60900.

**PlusMinus/Phillips**

283113

Order-No.	mm	mm	max. Nm		
34587	SL/PH1	75	6,0	3,8	5
34588	SL/PH2	75	6,0	5,5	5

Manufactured acc. to IEC 60900.

**PlusMinus/Pozidriv**

283114

Order-No.	mm	mm	max. Nm		
34589	SL/PZ1	75	6,0	3,8	5
34590	SL/PZ2	75	6,0	5,5	5

Manufactured acc. to IEC 60900.

**TORX®**

283115

Order-No.	mm	mm	max. Nm		
43140	T5	75	6,0	0,4	5
43141	T6	75	6,0	0,4	5
43142	T7	75	6,0	0,4	5
35506	T8	75	6,0	1,3	5
41160	T9	75	6,0	1,3	5
35507	T10	75	6,0	3,8	5
35508	T15	75	6,0	5,0	5
35509	T20	75	6,0	5,5	5
36071	T25	75	6,0	5,5	5

• no slim version  
Manufactured acc. to IEC 60900.

**TORX PLUS®**

283116

Order-No.	mm	mm	max. Nm		
43143	5IP	75	6	0,5	5
43144	6IP	75	6	0,8	5
43145	7IP	75	6	1,3	5
43146	8IP	75	6	2,0	5
43147	9IP	75	6	3,0	5
43148	10IP	75	6	4,5	5
43149	15IP	75	6	5,5	5
43150	20IP	75	6	5,5	5
43151	25IP	75	6	5,5	5

• no slim version  
Manufactured acc. to IEC 60900.

**Square**

283117

Order-No.	mm	mm	max. Nm			
35510	#1	2,3	75	6,0	5,5	5
35511	#2	2,8	75	6,0	5,5	5

Manufactured acc. to IEC 60900.

**Hex**

283118

Order-No.	mm	mm	max. Nm		
37222	1,5	75	6,0	0,9	5
37223	2	75	6,0	1,8	5
37224	2,5	75	6,0	3,8	5
37147	3	75	6,0	5,5	5
37225	4	75	6,0	5,5	5
37226	5	75	6,0	5,5	5
37227	6	75	6,0	5,5	5

• no slim version. Manufactured acc. to IEC 60900.



slimVario® electric extension



**Improved access:** Deep-set screws can be reached easily. **Provides you with full protection:** Each tool individually tested at 10,000 V AC and approved for 1,000 V AC.

for slimBits

2831-07

Order-No.	⌀	mm	mm	mm	Icons
43292	6	69,5	13,3		6

slimVario® electric adapter



**Increases your efficiency:** Adapter allows nut driver to be fastened with speedE® and slimVario® handles. **Provides you with full protection:** Each tool individually tested at 10,000 V AC and approved for 1,000 V AC.

for 1/4" nut driver

2831-08

Order-No.	⌀	mm	mm	mm	mm	mm	Icons
43139	6	59	1/4"	12,4	1/4"		6

Fastening/jamming

INFOBOX:  
VDE interchangeable bit system

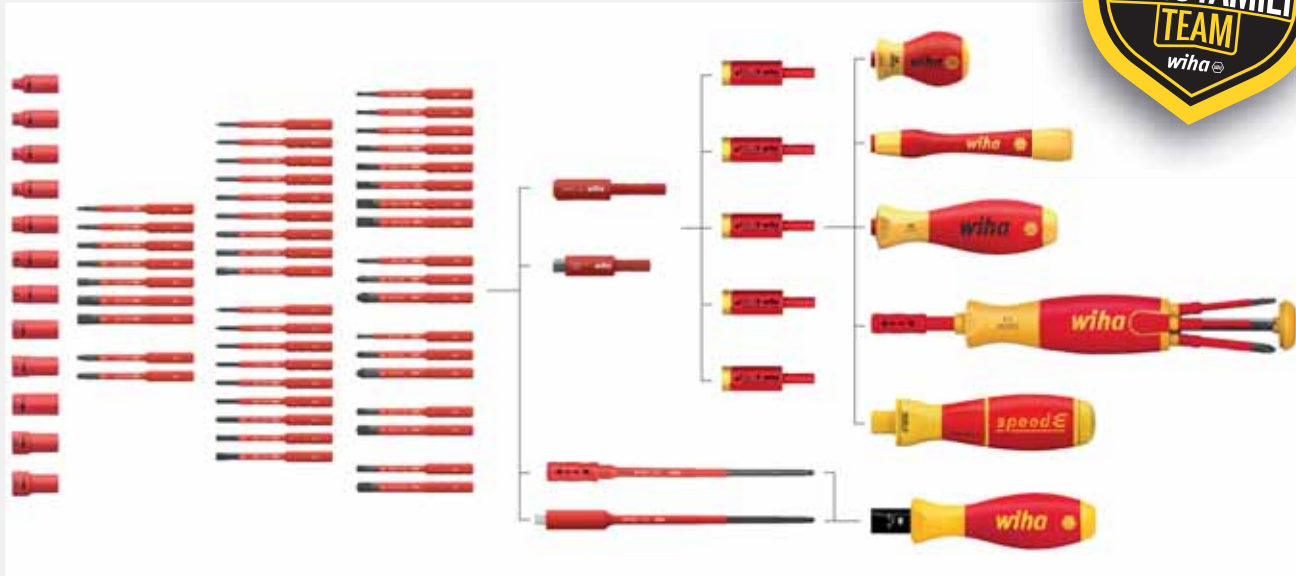

Can be used with these slimBits

- 1,5 / 2,0 / 2,5 / 3,0 / 3,5 / 4,0 / 5,5 / 6,5
- PH0 / PH1 / PH2
- PZ0 / PZ1 / PZ2
- SL/PZ1 / SL/PZ2
- T5 / T6 / T7 / T8 / T9 / T10 / T15 / T20 / T25
- IP5 / IP6 / IP7 / IP8 / IP9 / IP10 / IP15 / IP20 / IP25
- 1,5/2/2,5/3/4/5/6
- Robertson 1/2

VDE interchangeable bit system

- Compact VDE bit sets: holder + slimBit (length 75 mm))
- Wiha slimBits ensure good, protected access to deep-set screws.
- slimBits tested at 10,000 V AC and approved for 1,000 V AC.
- Space saved thanks to extensive interchangeable bit system and nut driver inserts.

VDE torque system

- Controlled tightening of electrical screw connections

Easier and protected access to deep-set screws.



Wiha slimTECHNOLOGY enables blades to be up to 33 % slimmer due to the integrated insulation in the blade. Low-lying screw and spring elements in the critical working area can therefore be reached easily. The high-quality blade insulation guarantees safe work in on live parts up to 1,000 V AC/1,500 V DC. Additional safety is assured as each individual screwdriver is tested in a water bath at 10,000 V AC in accordance with IEC 60900. Roll-off protection, the patented, SoftFinish® handle design that protects the hands and muscles from strain, and the unique handle-length concept for optimal balance between power and control all ensure healthier and more efficient work. The system for every electrician. Available as a screwdriver or as an interchangeable bit system

- **Increases your efficiency**  
Unique Wiha handle-length concept for optimum balance of torque and control.
- **Protects your health**  
With the patented SoftFinish® handle design, ensuring work is kind to hands and muscles. Recommended by doctors and therapists at German Campaign for Healthier Backs.
- **Provides you with full protection**  
Each tool individually tested at 10,000 V AC and approved for 1,000 V AC.
- **Increases your safety**  
Wiha slim blades grant unhindered, fully insulated access to low lying screws.



Screwdriver set SoftFinish® electric slimFix

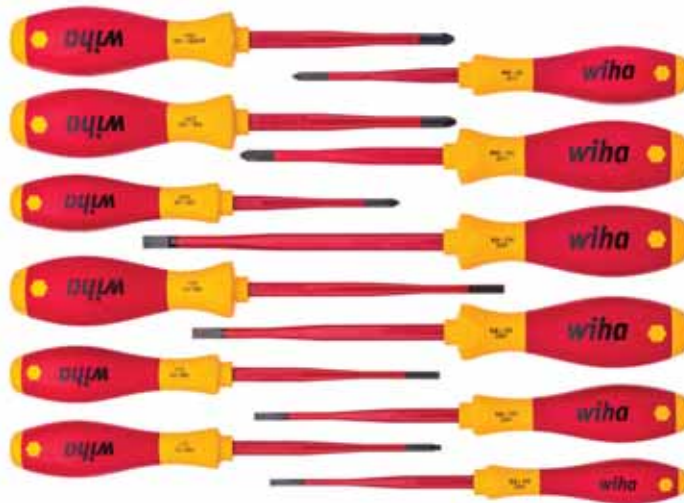

**Increases your safety:** Wiha slim blades ensure unlimited, protected access to deep-set screws. **Protects your health:** With the patented SoftFinish® handle design, ensuring work is kind to hands and muscles. Recommended by doctors and therapists at German Campaign for Healthier Backs. **Increases your efficiency:** Unique Wiha handle-length concept for optimum balance of torque and control. **Provides you with full protection:** Each tool individually tested at 10,000 V AC and approved for 1,000 V AC.

assorted 12-pcs.

3201 K12

Order-No.



41003

1

- ⊖ 3,5 x 100 / 4,0 x 100 / 5,5 x 125 / 6,5 x 150
- ⊕ PH1 x 80 / PH2 x 100
- ⊕ PZ1 x 80 / PZ2 x 100
- ⊕ SL/PZ2 x 100
- ⊕ T15 x 100 / T20 x 100 / T25 x 125

INFOBOX:  
Handle size concept



Wiha SoftFinish® handle sizes

- Every Wiha handle optimally balances guidance, speed and torque for the respective fastening task.
- Quick-turning - Motor skills are consistently taken into consideration.
- Maximum power transmission: comfortable and loss-free transmission of physical strength, even during intensive fastening.
- The power-turning and quick-turning zones (length) vary significantly over the four handle sizes in various forms.
- The Wiha SoftFinish screwdrivers enable work that is kind on the hands and muscles and is therefore recommended by doctors and therapists from the AGR.





**Increases your safety:** Wiha slim blades ensure unlimited, protected access to deep-set screws. **Protects your health:** With the patented SoftFinish® handle design, ensuring work is kind to hands and muscles. Recommended by doctors and therapists at German Campaign for Healthier Backs. **Increases your efficiency:** Unique Wiha handle-length concept for optimum balance of torque and control. **Provides you with full protection:** Each tool individually tested at 10,000 V AC and approved for 1,000 V AC.

**Slotted, Phillips 6-pcs.**

3201 K6

Order-No.



35389

1

⊖ 3,5 x 100 / 4,0 x 100 / 5,5 x 125 / 6,5 x 150

⊕ PH1 x 80 / PH2 x 100

Manufactured acc. to IEC 60900.

**Slotted, Pozidriv 6-pcs.**

3201 ZK6

Order-No.



36455

1

⊖ 3,5 x 100 / 4,0 x 100 / 5,5 x 125 / 6,5 x 150

⊕ PZ1 x 80 / PZ2 x 100

Manufactured acc. to IEC 60900.

**Slotted, Phillips, PlusMinus/Pozidriv 6-pcs.**

3201 K601

Order-No.



38362

1

⊖ 3,5 x 100 / 4,0 x 100 / 5,5 x 125

⊕ PH1 x 80 / PH2 x 100

⊕ SL/PZ2 x 100

Manufactured acc. to IEC 60900.

**TORX® 6-pcs.**

3251 K6

Order-No.



36558

1

⊕ T8 x 60 • / T9 x 60 •

⊕ T10 x 100 / T15 x 100 / T20 x 100 / T25 x 125

• no slim version

Manufactured acc. to IEC 60900.

Screwdriver SoftFinish® electric slimFix



**Increases your safety:** Wiha slim blades ensure unlimited, protected access to deep-set screws. **Protects your health:** With the patented SoftFinish® handle design, ensuring work is kind to hands and muscles. Recommended by doctors and therapists at German Campaign for Healthier Backs. **Increases your efficiency:** Unique Wiha handle-length concept for optimum balance of torque and control. **Provides you with full protection:** Each tool individually tested at 10,000 V AC and approved for 1,000 V AC.

⊖ Slotted 3201

Order-No.	⊖	mm	mm	mm	mm	mm	mm
35446	3,5	100	0,6	204	23	10	
35390	4,0	100	0,8	211	30	10	
35501	4,5	125	1,0	236	30	10	
35391	5,5	125	1,0	243	36	10	
35392	6,5	150	1,2	268	36	10	

DIN ISO 2380. Manufactured acc. to IEC 60900.

⊕ Phillips 3211

Order-No.	⊕	mm	mm	mm	mm	mm	mm
35393	PH1	80	191	30	10		
35394	PH2	100	218	36	10		

DIN ISO 8764-PH. Manufactured acc. to IEC 60900.

⊕ Pozidriv 3241

Order-No.	⊕	mm	mm	mm	mm	mm	mm
35395	PZ1	80	191	30	10		
35396	PZ2	100	218	36	10		

DIN ISO 8764-PZ. Manufactured acc. to IEC 60900.

⊕ PlusMinus/Phillips 3271

Order-No.	⊕	mm	mm	mm	mm	mm	mm
35502	SL/PH1	80	191	30	10		
35503	SL/PH2	100	218	36	10		

Manufactured acc. to IEC 60900.

⊕ PlusMinus/Pozidriv 3281

Order-No.	⊕	mm	mm	mm	mm	mm	mm
36329	SL/PZ1	80	191	30	10		
36330	SL/PZ2	100	218	36	10		

Manufactured acc. to IEC 60900.

⊕ TORX® Tamper Resistant (with hole) 3251 TR

Order-No.	⊕	mm	mm	mm	mm	mm	mm
41141	T10H	100	204	23	10		
41142	T15H	100	211	30	10		
41143	T20H	100	211	30	10		
41144	T25H	125	243	36	10		
41145	T27H	125	243	36	10		
41146	T30H	125	243	36	10		
41147	T40H	150	268	36	10		

Manufactured acc. to IEC 60900.

⊕ TORX® 3251

Order-No.	⊕	mm	mm	mm	mm	mm	mm
36536	T10	100	204	23	10		
36537	T15	100	211	30	10		
36538	T20	100	211	30	10		
36539	T25	125	243	36	10		
36540	T27	125	243	36	10		
36541	T30	125	243	36	10		
36542	T40	150	268	36	10		

DIN ISO 8764-PH. Manufactured acc. to IEC 60900.

⊕ Square 3581

Order-No.	⊕	mm	mm	mm	mm	mm	mm
35504	#1	2,3	100	211	30	10	
35505	#2	2,8	125	243	36	10	

Manufactured acc. to IEC 60900.

Screwdriver set SoftFinish® electric



Fastening/jamming

**Protects your health:** With the patented SoftFinish® handle design, ensuring work is kind to hands and muscles. Recommended by doctors and therapists at German Campaign for Healthier Backs. **Increases your efficiency:** Unique Wiha handle-length concept for optimum balance of torque and control. **Provides you with full protection:** Each tool individually tested at 10,000 V AC and approved for 1,000 V AC.

**Slotted, Phillips 7-pcs.**

320N K7

Order-No.



00834

1

⊖ 2,5 x 75 / 4,0 x 100 / 5,5 x 125 / 6,5 x 150

⊕ PH1 x 80 / PH2 x 100

⊖ Voltage tester SoftFinish® single-pole, 110-250 volts Slotted transparent, with push-on clip

Manufactured acc. to IEC 60900.

**Slotted, Phillips 6-pcs.**

320N K6

Order-No.



00833

10

⊖ 3,0 x 100 / 4,0 x 100 / 5,5 x 125 / 6,5 x 150

⊕ PH1 x 80 / PH2 x 100

Manufactured acc. to IEC 60900.

**Slotted, Pozidriv 6-pcs.**

320N ZK6 SO

Order-No.



25477

1

⊖ 2,5 x 75 / 3,5 x 100 / 4,5 x 125 / 5,5 x 125

⊕ PZ1 x 80 / PZ2 x 100

Manufactured acc. to IEC 60900.

Screwdriver SoftFinish® electric



**Protects your health:** With the patented SoftFinish® handle design, ensuring work is kind to hands and muscles. Recommended by doctors and therapists at German Campaign for Healthier Backs. **Increases your efficiency:** Unique Wiha handle-length concept for optimum balance of torque and control. **Provides you with full protection:** Each tool individually tested at 10,000 V AC and approved for 1,000 V AC.

⊖ Slotted

320N

Order-No.	⊖	↔	⊖	mm	↔	📦
00819	2,0	60	0,4	164	23	10
00820	2,5	75	0,4	179	23	10
00821	3,0	100	0,5	204	23	10
00822	3,5	100	0,6	204	23	10
00823	4,0	100	0,8	211	30	10
00824	4,5•	125	1,0	236	30	10
00825	4,5•	175	1,0	286	30	5
31863	4,5	200	1,0	311	30	5
00826	5,5	125	1,0	243	36	10
00827	5,5•	175	1,0	293	36	5
00828	6,0•	150	1,2	268	36	10
00829	6,5	150	1,2	268	36	10
00830	8,0	175	1,2	299	41	10
00831	8,0	175	1,6	299	41	10
00832	10,0•	200	1,6	324	41	5

• Additional dimension. Non-DIN size.  
Manufactured acc. to IEC 60900.

⊕ Phillips

321N

Order-No.	⊕	↔	mm	↔	📦
00846	PH0	60	164	23	10
00847	PH1	80	191	30	10
00848	PH2	100	218	36	10
00849	PH3	150	268	41	10
00850	PH4	200	318	41	5

Manufactured acc. to IEC 60900.

⊕ Pozidriv

324

Order-No.	⊕	↔	mm	↔	📦
00877	PZ0	60	164	23	10
00878	PZ1	80	191	30	10
00879	PZ2	100	218	36	10
00880	PZ3	150	324	41	5

Manufactured acc. to IEC 60900.

⊕ PlusMinus/Phillips

327

Order-No.	⊕	↔	mm	↔	📦
30716	SL/PH1	80	191	30	10
30715	SL/PH2	100	218	36	10

Manufactured acc. to IEC 60900.

⊕ PlusMinus/Pozidriv

328

Order-No.	⊕	↔	mm	↔	📦
30700	SL/PZ1	80	191	30	10
30701	SL/PZ2	100	218	36	10

Manufactured acc. to IEC 60900.

⊕ TORX®

325

Order-No.	⊕	↔	mm	↔	📦
03760	T5	60	164	23	10
03761	T6	60	164	23	10
03762	T7	60	164	23	10
00881	T8	60	164	23	10
00882	T9	60	164	23	10

Manufactured acc. to IEC 60900.

● Hex

323N

Order-No.	●	↔	mm	↔	📦
30361	2,5	75	179	23	10
30362	3,0	75	179	23	10
30363	4,0	75	186	30	10
30364	5,0	75	186	30	10
30365	6,0	100	218	36	10
30366	8,0	100	218	36	10

Manufactured acc. to IEC 60900.

■ Square

358N

Order-No.	■	■	↔	mm	↔	📦
32396	#1	2,3	100	211	30	10
32397	#2	2,8	150	268	36	10

Manufactured acc. to IEC 60900.



Screwdriver set SoftFinish® electric



**Protects your health:** With the patented SoftFinish® handle design, ensuring work is kind to hands and muscles. Recommended by doctors and therapists at German Campaign for Healthier Backs. **Increases your efficiency:** Unique Wiha handle-length concept for optimum balance of torque and control. **Provides you with full protection:** Each tool individually tested at 10,000 V AC and approved for 1,000 V AC.

Hexagon nut driver 5-pcs.

322 K5

Order-No.	⊙	mm	mm	mm	mm	mm
29466	⊙	5,5 x 125 / 7 x 125 / 8 x 125 / 10 x 125 / 13 x 125				

Manufactured acc. to IEC 60900.

Screwdriver SoftFinish® electric



**Protects your health:** With the patented SoftFinish® handle design, ensuring work is kind to hands and muscles. Recommended by doctors and therapists at German Campaign for Healthier Backs. **Increases your efficiency:** Unique Wiha handle-length concept for optimum balance of torque and control. **Provides you with full protection:** Each tool individually tested at 10,000 V AC and approved for 1,000 V AC.

Hex nut driver

322

Order-No.	⊙	mm	mm	mm	mm	mm	mm
00853	4	125	236	30	10,2		10
00855	5	125	236	30	11,2		10
00856	5,5	125	236	30	11,2		10
00857	6	125	236	30	12,2		10
00858	7	125	243	36	14,5		10
00859	8	125	243	36	15,2		10
00860	9	125	243	36	16,0		10
00861	10	125	243	36	17,2		10
00862	11	125	243	41	19,2		10
00863	12	125	243	41	20,2		10
00864	13	125	243	41	22,2		10
00865	14	125	243	41	23,2		10
00866	15	125	243	41	25,2		10
00867	16	125	243	41	25,2		10
00868	17	125	243	41	27,2		10

Manufactured acc. to IEC 60900.

INFOBOX:  
Combination profiles

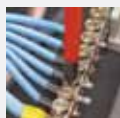

PlusMinus.

- The special PlusMinus/Pozidriv profile is ideal for PlusMinus terminal screws.
- The combination profile reduces slipping out and guarantees a higher torque transmission.

Fine screwdriver set PicoFinish® electric



**Simplifies your work:** With a practical plastic holder to hang up or stand on a surface. **Facilitates handling:** Extra-long rotating cap ensures optimum feed. **Increases your efficiency:** Screwdriver handle size concept ensures optimum feed. **Increases your efficiency:** Screwdriver handle size concept for an optimal balance between precision and control. **Provides you with full protection:** Each tool individually tested at 10,000 V AC and approved for 1,000 V AC. **Increases your precision:** Sensitive working and controlled power transmission thanks to the slim handle with a soft grip.

Slotted, Phillips, 6 pcs. with holder

227P

Order-No.	⊖	➤	●	mm	➤	📦
42989			1			
⊖	2,0 x 50 / 2,5 x 65 / 3 x 65 / 1,5 x 50					
⊕	PH00 x 50 / PH0 x 65					

Fine screwdriver PicoFinish electric



**Facilitates handling:** Extra-long rotating cap ensures optimum feed. **Increases your efficiency:** Screwdriver handle size concept for an optimal balance between precision and control. **Provides you with full protection:** Each tool individually tested at 10,000 V AC and approved for 1,000 V AC. **Increases your precision:** Sensitive working and controlled power transmission thanks to the slim handle with a soft grip.

⊖ Slotted

2270P

Order-No.	⊖	➤	●	mm	➤	📦
42374	1,5	50	2,0	152	18	10
42375	2,0	50	2,0	152	18	10
42376	2,5	65	2,5	167	18	10
42377	3	65	3	167	18	10
42471	3,5	65	3,5	167	18	10

⊕ Phillips

2271P

Order-No.	⊕	➤	●	mm	➤	📦
42379	PH00	50	2	152	18	10
42378	PH0	65	3	167	18	10
42380	PH1	65	4	167	18	10

INFOBOX:  
PicoFinish electric



**Wiha PicoFinish electric: The VDE-GS tested precision screwdriver.**

- The smooth-running turn-cap enables fast turning.
- Imprint with the screw symbol and sizes eases recognition.

L-key with T-handle electric



**Simplifies your work:** More power when fastening thanks to the leverage from the T-handle design **Increases your efficiency:** Handle size concept for an optimum balance between torque and control **Provides you with full protection:** Each tool individually tested at 10,000 V AC and approved for 1,000 V AC.

Nut driver with T-handle electric



**Simplifies your work:** More power when fastening thanks to the leverage from the T-handle design **Increases your efficiency:** Handle size concept for an optimum balance between torque and control **Provides you with full protection:** Each tool individually tested at 10,000 V AC and approved for 1,000 V AC.

Fastening/jamming

Hex

334N

Order-No.	●	↔	↔	↔	↔	📦
27928	4	150	176	80	26	10
27929	5	150	182	100	32	10
27930	6	150	182	100	32	10
27931	8	150	182	100	32	10

Manufactured acc. to IEC 60900.

Hex

336N

Order-No.	○	↔	↔	↔	↔	📦
27932	8	200	232	100	32	10
27933	10	230	262	100	32	10
27934	13	230	262	100	32	10
27935	17	230	268	120	38	10

Manufactured acc. to IEC 60900.

Single, insulated open-end spanner



**Improved access:** Through the 15° position of jaws, light work is made of fastening even in restricted spaces. **Provides you with full protection:** Each tool individually tested at 10,000 V AC and approved for 1,000 V AC. **Protects your material:** Fully insulated tool reduces the risk of short circuits.

Adjustable spanner electric



**Meets your requirements:** Continuously adjustable spanner width for a large application field. **Provides you with full protection:** Each tool individually tested at 10,000 V AC and approved for 1,000 V AC.

5590N

Order-No.	⊙	↔ mm	
43026	6	90	1
43027	7	90	1
43028	8	100	1
43029	9	100	1
43030	10	110	1
43031	11	110	1
43032	12	130	1
43033	13	135	1
43034	14	145	1
43035	15	150	1
43036	16	160	1
43037	17	160	1
43038	18	175	1
43039	19	175	1
43040	22	195	1
43041	24	225	1
43042	27	250	1
43043	30	290	1
43044	32	310	1

Manufactured according to EN/IEC 60900.

Adjustable between 0-30 mm

5590NA

Order-No.	⊙	↔ mm	
43061	0 - 30	250	1

Manufactured according to EN/IEC 60900.

Insulated nut driver insert



**Provides you with full protection:** Each tool individually tested at 10,000 V AC and approved for 1,000 V AC. **Protects your material:** Fully insulated tool reduces the risk of short circuits.

1/2" hexagon head

7208NS

Order-No.	⊙	↔ mm	
43077	10	55	1
43078	11	55	1
43079	12	55	1
43080	13	55	1
43081	14	55	1
43082	17	55	1
43083	19	55	1
43084	22	55	1
43085	24	55	1
43086	27	55	1
43087	32	55	1

Manufactured according to EN/IEC 60900.



Insulated nut driver insert



**Provides you with full protection:** Each tool individually tested at 10,000 V AC and approved for 1,000 V AC. **Protects your material:** Fully insulated tool reduces the risk of short circuits.

○ 3/8" hexagon head

7207NS

Order-No.	⌀	mm	
43065	8	45	1
43066	10	45	1
43067	11	45	1
43068	12	45	1
43069	13	45	1
43070	14	45	1
43071	16	45	1
43072	17	45	1
43073	18	45	1
43074	19	47	1
43075	21	47	1
43076	22	47	1

Manufactured according to EN/IEC 60900.

Insulated nut driver insert



**Provides you with full protection:** Each tool individually tested at 10,000 V AC and approved for 1,000 V AC. **Protects your material:** Fully insulated tool reduces the risk of short circuits.

○ 1/4" hexagon head

7209NS

Order-No.	⌀	mm	
43088	4	42	1
43089	5	42	1
43090	5,5	42	1
43091	6	42	1
43092	7	42	1
43093	8	42	1
43094	9	42	1
43095	10	42	1
43096	11	42	1
43097	12	42	1
43098	13	42	1
43099	14	42	1

Manufactured according to EN/IEC 60900.

Insulated nut driver insert



**Provides you with full protection:** Each tool individually tested at 10,000 V AC and approved for 1,000 V AC.

● 1/2" internal hexagon

7208NHS

Order-No.	●	mm	
43100	4	120	1
43101	5	120	1
43102	6	120	1
43103	8	120	1
43104	10	120	1

Manufactured according to EN/IEC 60900.

Insulated nut driver insert



**Provides you with full protection:** Each tool individually tested at 10,000 V AC and approved for 1,000 V AC.

● 1/4" internal hexagon

7209NHS

Order-No.	●	mm	
43109	3	65	1
43110	4	65	1
43111	5	65	1
43112	6	65	1
43113	8	65	1

Insulated nut driver insert



**Provides you with full protection:** Each tool individually tested at 10,000 V AC and approved for 1,000 V AC.

● 3/8" internal hexagon

7207NHS

Order-No.	●	mm	
43105	4	75	1
43106	5	75	1
43107	6	75	1
43108	8	75	1

Manufactured according to EN/IEC 60900.

**Ratchet wrench insulated for nut drivers**



**Protects your health:** Reduction of the risk of injury by increasing the hand working space. **Provides you with full protection:** Each tool individually tested at 10,000 V AC and approved for 1,000 V AC. **Increases your flexibility:** Adjustable right or left rotation through switching lever.

**Switchable**

7207NRW

Order-No.	■	t	mm	
43052	3/8"	200		1
43053	1/2"	250		1

Manufactured according to EN/IEC 60900.

**T-handle insulated for nut driver**



**Improved access:** Deep-set screws can be reached easily. **Provides you with full protection:** Each tool individually tested at 10,000 V AC and approved for 1,000 V AC.

24618T

Order-No.	■	t	mm	
43063	1/2"	200		10
43062	3/8"	200		10

Manufactured according to EN/IEC 60900.

**Insulated extension**



**Improved access:** Deep-set screws can be reached easily. **Provides you with full protection:** Each tool individually tested at 10,000 V AC and approved for 1,000 V AC.

**1/2" square adapter for nut driver inserts, insulated**

7208NE

Order-No.	■	t	mm	
43055	1/2"	125		1
43056	1/2"	250		1

Manufactured according to EN/IEC 60900.

**3/8" square adapter for nut driver inserts, insulated**

7207NE

Order-No.	■	t	mm	
43057	3/8"	125		1
43058	3/8"	250		1

Manufactured according to EN/IEC 60900.

Switch cabinet key pen shape



**Increases your efficiency:** All keys and profiles integrated into one compact, lightweight tool.

in blister pack

24681

Order-No.							
39076	5-8	9	3-5	7,0	PH2	T20 / T25	1

Switch cabinet key cross shape

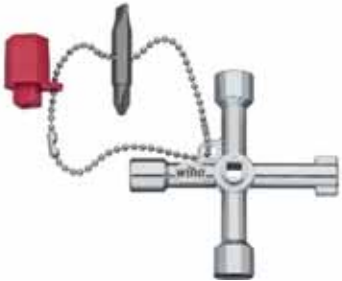

**Increases your efficiency:** All keys and profiles integrated into one compact, lightweight tool.

in blister pack

24667

Order-No.						
36114	5-8	9	3-5	7,0	PH2	1

INFOBOX:  
Solid steel cap and hexagon head



- The solid steel cap at the end of the screwdriver handle enables targeted hammering, e.g. to loosen jammed screws.
- The direct connection of the solid steel cap to the blade means that the impact energy is transmitted without any loss.
- Blade includes a hexagon bolster for using a set of spanners for additional torque.

Screwdriver SoftFinish®



**Simplifies your work:** Striking cap integrated into the handle allows you to strike and lift with the screwdriver. **Facilitates handling:** Easy loosening of tight screws thanks to hex bolster for spanners. **Protects your health:** With the patented SoftFinish® handle design, ensuring work is kind to hands and muscles. Recommended by doctors and therapists at German Campaign for Healthier Backs. **Increases your efficiency:** Screwdriver handle size concept for an optimal balance between precision and control.

Slotted with one-piece hexagonal blade and solid steel cap

530

Order-No.						mm	
03223	3,5	75	0,6	4.0	-	186	10
03224	4,5•	90	0,8	4.0	-	201	10
03225	5,5	100	1,0	5.0	8	213	10
03226	6,5	125	1,2	6.0	10	238	10
03228	8,0	150	1,2	8.0	13	271	5
03230	10,0	175	1,6	8.0	13	296	5
03231	12,0	200	2,0	10.0	16	321	5
03232	14,0•	250	2,5	10.0	16	371	5

• Additional dimension. Non-DIN size.

Phillips with one-piece hexagonal blade and solid steel cap

531

Order-No.					mm		
03237	PH1	80	5,0	8	186	30	10
03238	PH2	100	6,0	10	213	36	10
03239	PH3	150	8,0	13	268	41	10

Pozidriv with one-piece hexagonal blade and solid steel cap

532

Order-No.					mm		
03245	PZ1	80	5,0	8	186	30	10
03246	PZ2	100	6,0	10	213	36	10
03247	PZ3	150	8,0	13	268	41	10



Screwdriver SoftFinish®



**Protects your health:** With the patented SoftFinish® handle design, ensuring work is kind to hands and muscles. Recommended by doctors and therapists at German Campaign for Healthier Backs. **Increases your efficiency:** Unique Wiha handle-length concept for optimum balance of torque and control.

Screwdriver SoftFinish®



**Protects your health:** With the patented SoftFinish® handle design, ensuring work is kind to hands and muscles. Recommended by doctors and therapists at German Campaign for Healthier Backs. **Increases your efficiency:** Unique Wiha handle-length concept for optimum balance of torque and control.

⊖ Slotted with round blade for low-lying screws

302

Order-No.	⊖	↔	⊖	●	mm	↔	📦
00684	2,0	65	0,4	2,0	169	23	10
00685	2,5	75	0,4	2,5	179	23	10
00686	3,0	80	0,5	3,0	184	23	10
00687	3,0	100	0,5	3,0	204	23	10
00689	3,0	150	0,5	3,0	254	23	10
00690	3,0	200	0,5	3,0	304	23	10
32383	3,0	300	0,5	3,0	404	23	5
00691	3,5	100	0,6	3,5	204	23	10
26931	3,5	200	0,6	3,5	304	23	10
00692	4,0	100	0,8	4,0	211	30	10
00694	4,0	150	0,8	4,0	261	30	10
00695	4,0	200	0,8	4,0	311	30	10
00696	4,0	300	0,8	4,0	411	30	10
27753	4,5	80	0,8	4,5	191	30	10
00697	4,5	125	0,8	4,5	236	30	10
00698	5,5	125	1,0	5,5	236	30	10
00700	5,5	150	1,0	5,5	261	30	10
00701	5,5	200	1,0	5,5	311	30	10
00702	5,5	300	1,0	5,5	411	30	5
32384	6,0	300	1,0	6,0	418	36	5

• Additional dimension. Non-DIN size.

⊖ Slotted with round blade

3022

Order-No.	⊖	↔	⊖	●	mm	↔	📦
27754	6,0	100	1,0	5,5	218	36	10
27755	6,0	150	1,0	5,5	268	36	10
00704	6,5	100	1,2	6,0	218	36	10
00703	6,5	150	1,2	6,0	268	36	10
00706	6,5	200	1,2	6,0	318	36	10
00708	8,0	150	1,2	7,0	274	41	10
00707	8,0	175	1,2	7,0	299	41	10
00709	8,0	175	1,6	7,0	299	41	5
32399	8,0	300	1,2	7,0	424	41	5
00711	10,0	200	1,6	8,0	324	41	10
32400	10,0	300	1,6	8,0	424	41	5
00712	12,0	250	2,0	8,0	374	41	10
00713	14,0	250	2,5	11,0	374	41	10

• Additional dimension. Non-DIN size. DIN ISO 2380.

**Bit holder CentroFix mechanically lockable**



**Simplifies your work:** Ideal for all applications due to the non-magnetic locking mechanism. **Increases your efficiency:** Extremely secure and tight zero-play hold of bits.

Ø 1/4"

7148C

Order-No.	Ø	mm	mm	
32477	1/4	1/4	60	10

**Bit holder magnetic, clamping with retaining ring**



**Simplifies your work:** Unrestricted access to low-lying screws thanks to bit holder lengths of up to 250mm. **Increases your efficiency:** Unlimited access to deep-set screws thanks to extreme slimline design.

Ø 1/4"

7143

Order-No.	Ø	mm	mm	
01913	1/4	1/4	72	2
36092	1/4	1/4	100	5
34306	1/4	1/4	150	5
36093	1/4	1/4	200	5
36094	1/4	1/4	250	5

**Bit holder CentroFix Super Slim mechanically lockable**



**Saves time:** Automatic bit locking mechanism upon insertion. **Increases your efficiency:** Unlimited access to deep-set screws thanks to extreme slimline design.



Ø 1/4", magnetic

7148 CS

Order-No.	Ø	mm	mm	
39134	1/4	1/4	66	1



**Meets your requirements:** Robust and precise bits for general fastening in trade and industry. **Saves time:** Simple and quick recognition of profile sizes thanks to contrasting laser marking. **Increases your efficiency:** Best rotation characteristics for stable fastening processes.

**⊖ Slotted 1/4"**

7040 Z

Order-No.	⊖	mm	⊖	
33961	2,5	70	0,4	5
01790	3,0	50	0,5	5
33962	3,0	70	0,5	5
01792	3,5	50	0,6	5
33963	3,5	70	0,6	5
01791	4,0	50	0,5	5
01794	4,0	50	0,8	5
33964	4,0	70	0,8	5
01793	4,5	50	0,6	5
01795	5,5	50	0,8	5
01796	5,5	50	1,0	5
33965	5,5	70	1,0	5
01798	6,5	50	1,2	5
33966	6,5	70	1,2	5
01799	8,0	50	1,2	5
01800	8,0	50	1,6	5

**⊕ Pozidriv 1/4"**

7042 Z

Order-No.	⊕	mm	
31957	PZ0	50	5
31958	PZ0	70	5
31959	PZ0	90	5
33706	PZ1	50	5
01808	PZ1	70	5
01809	PZ1	90	5
23221	PZ1	110	5
23225	PZ1	127	5
23227	PZ1	150	5
33707	PZ2	50	5
01811	PZ2	70	5
01812	PZ2	90	5
05799	PZ2	110	5
06889	PZ2	127	5
23228	PZ2	150	5
33708	PZ3	50	5
04059	PZ3	70	5
04176	PZ3	90	5
23223	PZ3	110	5
23226	PZ3	127	5
22512	PZ3	150	5

**⊕ Phillips 1/4"**

7041 Z

Order-No.	⊕	mm	
31960	PH00	50	5
31961	PH00	70	5
31962	PH00	90	5
32105	PH0	50	5
35456	PH0	70	5
35457	PH0	90	5
33703	PH1	50	5
01803	PH1	70	5
04126	PH1	90	5
23213	PH1	110	5
23219	PH1	127	5
22509	PH1	150	5
33704	PH2	50	5
01805	PH2	70	5
04009	PH2	90	5
05800	PH2	110	5
06888	PH2	127	5
22510	PH2	150	5
33705	PH3	50	5
04010	PH3	70	5
04127	PH3	90	5
23215	PH3	110	5
23217	PH3	127	5
22511	PH3	150	5



**⊕ PlusMinus/Phillips 1/4"**

7049PHM

Order-No.	⊕	mm	
32490	SL/PH1	50	5
32491	SL/PH1	70	5
32686	SL/PH1	90	5
32492	SL/PH2	50	5
32493	SL/PH2	70	5
32687	SL/PH2	90	5



**PlusMinus/Pozidriv 1/4"**

7049PZM

Order-No.		mm	
32494	SL/PZ1	50	5
32495	SL/PZ1	70	5
32688	SL/PZ1	90	5
32496	SL/PZ2	50	5
32497	SL/PZ2	70	5
32689	SL/PZ2	90	5



**TORX® MagicSpring® 1/4"**

7045R

Order-No.		mm	
34452	T10	50	5
34453	T15	50	5
34454	T20	50	5
34455	T25	50	5
34456	T30	50	5
34457	T40	50	5



**TORX® ball end 1/4"**

7045BE

Order-No.		mm	
32409	T9	50	5
32410	T10	50	5
32416	T10	70	5
32417	T15	50	5
32418	T15	70	5
32411	T20	50	5
32419	T20	70	5
32412	T25	50	5
32421	T25	70	5
32413	T27	50	5
32414	T30	50	5
32423	T30	70	5
32415	T40	50	5

**TORX® 1/4"**



7045 Z

Order-No.		mm	
39184	T1	50	5
39185	T2	50	5
39186	T3	50	5
39187	T4	50	5
32299	T5	50	5
32302	T6	50	5
33709	T6	70	5
33717	T6	90	5
38370	T6	150	5
32303	T7	50	5
33710	T7	70	5
33718	T7	90	5
38371	T7	150	5
32304	T8	50	5
33711	T8	70	5
33719	T8	90	5

36327	T8	150	5
32305	T9	50	5
33712	T9	70	5
33720	T9	90	5
38372	T9	150	5
32306	T10	50	5
33713	T10	70	5
33721	T10	90	5
33725	T10	110	5
33726	T10	150	5
32307	T15	50	5
33714	T15	70	5
33722	T15	90	5
33727	T15	110	5
33728	T15	150	5
32308	T20	50	5
33715	T20	70	5
33723	T20	90	5
33729	T20	110	5
33730	T20	150	5
32309	T25	50	5
33716	T25	70	5
33724	T25	90	5
33731	T25	110	5
33732	T25	150	5
33920	T27	50	5
33921	T27	70	5
33922	T27	90	5
33923	T30	50	5
33924	T30	70	5
33925	T30	90	5
33926	T30	110	5
33927	T30	150	5
33928	T40	50	5
33929	T40	70	5
33930	T40	90	5
33931	T40	110	5
33932	T40	150	5

**TORX PLUS® 1/4"**

7046 Z



Order-No.		mm	
39195	1IP	50	5
39196	2IP	50	5
32486	3IP	50	5
39197	4IP	50	5
39198	4IP	90	5
28481	5IP	50	5
39199	5IP	90	5
31973	6IP	90	5
26000	6IP	50	5
26002	7IP	50	5
23195	8IP	50	5



31975	8IP	90	2
23197	9IP	50	5
23199	10IP	50	5
31977	10IP	90	5
23201	15IP	50	5
25553	15IP	90	5
23203	20IP	50	5
39200	20IP	90	5
23205	25IP	50	5
39201	25IP	90	5
23207	27IP	50	5
39202	27IP	90	5
23209	30IP	50	5
39203	30IP	90	5
23211	40IP	50	5
39204	40IP	90	5

### TORX® Tamper Resistant (with hole) 1/4"

7045 Z TR

Order-No.		mm	
21045	T7H	50	5
21047	T8H	50	5
20218	T9H	50	5
20219	T10H	50	5
39188	T10H	90	5
24867	T15H	50	5
39189	T15H	90	5
20220	T20H	50	5
39190	T20H	90	5
20221	T25H	50	5
39191	T25H	90	5
20222	T27H	50	5
39192	T27H	90	5
20223	T30H	50	5
39193	T30H	90	5
20224	T40H	50	5
39194	T40H	90	5

### Hexagonal ball end 1/4"

7047R Z

Order-No.		mm	
25739	3,0	50	5
25740	4,0	50	5
25741	5,0	50	5
25742	6,0	50	5



### MagicRing® hex 1/4"

7043R Z

Order-No.		mm	
23145	3,0	50	5
23147	4,0	50	5
23149	5,0	50	5
23151	6,0	50	5



### Hexagon 1/4"

7043 Z

Order-No.		mm	
05301	1,5	50	5
05302	2,0	50	5
34554	2,0	70	5
39178	2,0	90	5
05303	2,5	50	5
34555	2,5	70	5
39179	2,5	90	5
04194	3,0	50	5
34556	3,0	70	5
39180	3,0	90	5
04195	4,0	50	5
34557	4,0	70	5
39181	4,0	90	5
04196	5,0	50	5
34558	5,0	70	5
39182	5,0	90	5
04197	6,0	50	5
34559	6,0	70	5
39183	6,0	90	5
04198	8,0	50	5
34560	8,0	70	5



### Square 1/4"

7048 Z

Order-No.			mm	
06637	#1	2,3	50	5
39206	#1	2,3	90	5
06638	#2	2,8	50	5
39207	#2	2,8	90	5
06639	#3	3,3	50	5
39208	#3	3,3	90	5

### Torq-Set® 1/4"

7049 TS

Order-No.		mm	
22596	4	50	5
33699	4	90	5
22597	5	50	5
33700	5	90	5
22598	6	50	5
33701	6	90	5
22599	8	50	5
33702	8	90	5
22600	10	50	5

Screwdriver with LiftUp 25 magnetic bit magazine



**Simplifies your work:** Larger handle – maximum power. **Protects your health:** No risk of injury, all blades stowed safely inside the handle. **Increases your flexibility:** Standard bits are also suitable for machine operation.



Mixed with 12 bits, 1/4"

3803 02 021

Order-No.	
38601	5
⊖	1 x 5,5
⊕	1 x PH2
⊕	1 x PZ1 / 1 x PZ2 / 1 x PZ3
⊕	1 x T15 / 1 x T20 / 1 x T25 / 1 x T30
●	1 x 3,0 / 1 x 4,0 / 1 x 5,0

Screwdriver with bit magazine magnetic



**Saves space:** Six tools in one. **Increases your efficiency:** Unrestricted access to confined spaces thanks to extremely short screwdriver handle.

Slotted, Phillips with 6 bits, Stubby, 1/4"

3801 01

Order-No.	
33736	10
⊖	1 x 4,5 / 1 x 6,5 / 1 x 8,0
⊕	1 x PH1 / 1 x PH2 / 1 x PH3

TORX® with 6 bits, Stubby, 1/4"

3801 03

Order-No.	
33743	10
⊕	1 x T10 / 1 x T15 / 1 x T20 / 1 x T25 / 1 x T30 / 1 x T40

Slotted, Pozidriv with 6 bits, Stubby, 1/4"

3801 04

Order-No.	
33764	10
⊖	1 x 4,5 / 1 x 6,5 / 1 x 8,0
⊕	1 x PZ1 / 1 x PZ2 / 1 x PZ3





Three.For all your jobs.





Which machine? Which application? Which bit? The revolutionary Wiha bit concept puts an end to any confusion and presents three bit types which can cover all areas of use.

Only the screw shape is crucial for selecting the bit. The Y bit is ideal for fastening Y-shaped screws with an angle no greater than 90° between the thread and screw head. The T bit is used for T-shaped screws at a 90° angle. If you need to fasten both screw types, then the TY bit is the right choice since this universal bit is suitable for all type of fastenings.

- **Increases your efficiency**

The specialist with 120x greater lifespan\* thanks to optimised bits. \* Compared to Wiha standard bits

- **Lowers your costs**

Bit quick and easy to find thanks to marking – even in dark environments when a UV light is used.

- **Saves time**

No long searches thanks to fluorescent bit, infrequent bit replacement thanks to long lifespan.

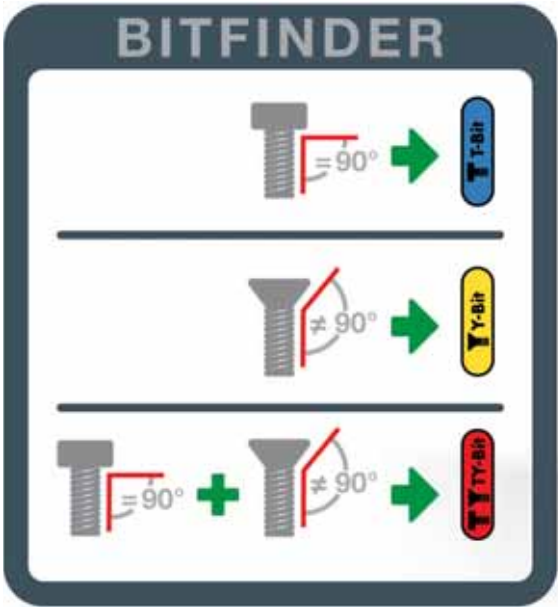

### BitBuddy® TY bit set, 49 mm



**Lowers your costs:** Bit quick and easy to find thanks to red marking – even in dark environments by using an UV light. **Saves time:** No long searches thanks to fluorescent bit, infrequent bit replacement thanks to long lifespan. Automatic opening at the push of a button and simple bit change directly in the holder. **Increases your efficiency:** The all-rounder with 120x greater lifespan\* thanks to patented bit technology, suitable for all screws. (\*compared to Wiha standard bit)



### Pozidriv 1/4" 7-pcs.

SB 7946-TY202

Order-No.	
42099	6
	1 x PZ1 / 5 x PZ2 / 1 x PZ3

### Hexagon 1/4" 7-pcs.

SB 7946-TY303

Order-No.	
42114	6
	2 x SW3 / 2 x SW4 / 2 x SW5 / 1 x SW6

### TORX® 1/4" 7-pcs.

SB 7946-TY505

Order-No.	
42115	6
	1 x T10 / 1 x T15 / 2 x T20 / 1 x T25 / 1 x T30 / 1 x T40

### Phillips, Pozidriv, TORX®, 7-pcs., 1/4"

SB 7946-TY903

Order-No.	
42116	6
	1 x PH2
	1 x PZ1 / 1 x PZ2 / 1 x PZ3
	1 x T15 / 1 x T20 / 1 x T25

### Phillips, Pozidriv, TORX®, 7-pcs., 1/4"

SB 7946-TY904

Order-No.	
42117	6
	1 x PH2
	1 x PZ1 / 1 x PZ2
	1 x T10 / 1 x T15 / 1 x T20 / 1 x T25

### Pozidriv, TORX® 7-pcs. 1/4" in box

SB 7946-TY905

Order-No.	
42118	6
	1 x PZ2 / 1 x PZ3
	1 x T15 / 1 x T20 / 1 x T25 / 1 x T30 / 1 x T40

### BitBuddy® TY bit set, 29 mm



**Lowers your costs:** Bit quick and easy to find thanks to red marking – even in dark environments by using an UV light. **Saves time:** No long searches thanks to fluorescent bit, infrequent bit replacement thanks to long lifespan. Automatic opening at the push of a button and simple bit change directly in the holder. **Increases your efficiency:** The all-rounder with 120x greater lifespan\* thanks to patented bit technology, suitable for all screws. (\*compared to Wiha standard bit)



### Pozidriv 1/4" 8-pcs.

SB 7945-TY202

Order-No.	
42098	6
	1 x PZ1 / 5 x PZ2 / 1 x PZ3
	1 x Bit holder magnetic extra strong magnet 1/4"



### Hexagon 8-pcs. 1/4"

SB 7945-TY303

Order-No.	
42135	6
	2 x SW3 / 2 x SW4 / 2 x SW5 / 1 x SW6
	1 x Bit holder magnetic extra strong magnet 1/4"





**TORX® 1/4" 8-pcs.**

SB 7945-TY505

Order-No.	
42136	6
	1 x T10 / 1 x T15 / 2 x T20 / 1 x T25 / 1 x T30 / 1 x T40
	1 x Bit holder magnetic extra strong magnet 1/4"





**Phillips, Pozidriv, TORX®, 8-pcs., 1/4"**

SB 7945-TY903

Order-No.	
42137	6
	1 x PH2
	1 x PZ1 / 1 x PZ2 / 1 x PZ3
	1 x T15 / 1 x T20 / 1 x T25
	1 x Bit holder magnetic extra strong magnet 1/4"





**Phillips, Pozidriv, TORX®, 8-pcs., 1/4"**

SB 7945-TY904

Order-No.	
42138	6
	1 x PH2
	1 x PZ1 / 1 x PZ2
	1 x T10 / 1 x T15 / 1 x T20 / 1 x T25
	1 x Bit holder magnetic extra strong magnet 1/4"

**Pozidriv, TORX®, 8-pcs., 1/4"**

SB 7945-TY905





Order-No.	
42139	6
	1 x PZ2 / 1 x PZ3
	1 x T15 / 1 x T20 / 1 x T25 / 1 x T30 / 1 x T40
	1 x Bit holder magnetic extra strong magnet 1/4"

**XLSelector T bit set, 50 mm**

**Lowers your costs:** Bit quick and easy to find thanks to blue marking – even in dark environments by using an UV light. **Saves time:** No long searches thanks to fluorescent bit, infrequent bit replacement thanks to long lifespan. **Increases your efficiency:** The specialist with 120x greater lifespan\* thanks to optimised bit for T-shaped screws\*(compared to Wiha standard bit)

**Phillips, TORX®, hex 13-pcs. 1/4"**

SB 7948-T950





Order-No.	
41831	6
	1 x PH1 / 1 x PH2 / 1 x PH3
	1 x T15 / 1 x T20 / 1 x T25 / 1 x T30 / 1 x T40
	1 x SW3 / 1 x SW4 / 1 x SW5 / 1 x SW6
	1 x Bit holder magnetic extra strong magnet 1/4"

**XLSelector T bit set, 25 mm**

**Lowers your costs:** Bit quick and easy to find thanks to blue marking – even in dark environments by using an UV light. **Saves time:** No long searches thanks to fluorescent bit, infrequent bit replacement thanks to long lifespan. **Increases your efficiency:** The specialist with 120x greater lifespan\* thanks to optimised bit for T-shaped screws\*(compared to Wiha standard bit)

**Phillips, TORX®, hex 31-pcs. 1/4"**

SB 7948-T999

Order-No.	
41830	6
	2 x PH1 / 4 x PH2 / 2 x PH3
	2 x T10 / 2 x T15 / 4 x T20 / 2 x T25 / 2 x T30 / 2 x T40
	2 x SW3 / 2 x SW4 / 2 x SW5 / 2 x SW6
	1 x Bit holder magnetic extra strong magnet 1/4"

### FlipSelector T bit set, 25 mm



**Lowers your costs:** Bit quick and easy to find thanks to blue marking – even in dark environments by using an UV light. **Saves time:** No long searches thanks to fluorescent bit, infrequent bit replacement thanks to long lifespan. Simple and rapid bit removal thanks to clear organisation and automatic opening at the push of a button. **Increases your efficiency:** The specialist with 120x greater lifespan\* thanks to optimised bit for T-shaped screws(\*compared to Wiha standard bit)

### XLSelector Y bit set, 50 mm



**Lowers your costs:** Bit quick and easy to find thanks to yellow marking – even in dark environments by using an UV light. **Saves time:** No long searches thanks to fluorescent bit, infrequent bit replacement thanks to long lifespan. **Increases your efficiency:** The specialist with 120x greater lifespan\* thanks to optimised bit for Y-shaped screws(\*compared to Wiha standard bit)

### Hexagon 16-pcs. 1/4"

SB 7947-T303

Order-No.	
41825	6
	3 x SW3 / 3 x SW4 / 3 x SW5 / 3 x SW6
	1 x Bit holder magnetic extra strong magnet 1/4"

### Phillips, Pozidriv, TORX®, 13-pcs., 1/4"

SB 7947-T906

Order-No.	
41824	6
	1 x PH1 / 3 x PH2 / 1 x PH3
	1 x PZ2
	1 x T10 / 1 x T15 / 1 x T20 / 1 x T25 / 1 x T30 / 1 x T40
	1 x Bit holder magnetic extra strong magnet 1/4"

### assorted 1/4" 13-pcs.

SB 7947-T999

Order-No.	
41826	6
	1 x PH1 / 1 x PH2 / 1 x PH3
	1 x PZ2
	1 x T15 / 1 x T20 / 1 x T25 / 1 x T30 / 1 x T40
	1 x SW4 / 1 x SW5 / 1 x SW6
	1 x Bit holder magnetic extra strong magnet 1/4"

### Phillips, Pozidriv, TORX®, 13-pcs., 1/4"

SB 7948-Y950

Order-No.	
41834	6
	2 x PH2
	1 x PZ1 / 2 x PZ2 / 1 x PZ3
	1 x T10 / 1 x T15 / 1 x T20 / 1 x T25 / 1 x T30 / 1 x T40
	1 x Bit holder magnetic extra strong magnet 1/4"



**XLSelector Y bit set, 25 mm**



**Lowers your costs:** Bit quick and easy to find thanks to yellow marking – even in dark environments by using an UV light. **Saves time:** No long searches thanks to fluorescent bit, infrequent bit replacement thanks to long lifespan. **Increases your efficiency:** The specialist with 120x greater lifespan\* thanks to optimised bit for Y-shaped screws(\*compared to Wiha standard bit)

**FlipSelector Y bit set, 25 mm**



**Lowers your costs:** Bit quick and easy to find thanks to yellow marking – even in dark environments by using an UV light. **Saves time:** No long searches thanks to fluorescent bit, infrequent bit replacement thanks to long lifespan. Simple and rapid bit removal thanks to clear organisation and automatic opening at the push of a button. **Increases your efficiency:** The specialist with 120x greater lifespan\* thanks to optimised bit for Y-shaped screws(\*compared to Wiha standard bit)

Fastening/jamming

**TORX® 31-pcs. 1/4"**

SB 7948-Y505

Order-No.



41833

6

- ⊕ 3 x T10 / 6 x T15 / 6 x T20 / 6 x T25 / 6 x T30 / 3 x T40
- 1 x Bit holder magnetic extra strong magnet 1/4"

**Pozidriv 1/4" 13-pcs.**

SB 7947-Y202

Order-No.



41829

6

- ⊕ 2 x PZ1 / 8 x PZ2 / 2 x PZ3
- 1 x Bit holder magnetic extra strong magnet 1/4"

**Phillips, Pozidriv, TORX®, 31-pcs., 1/4"**

SB 7948-Y904

Order-No.



41832

6

- ⊕ 1 x PH1 / 1 x PH3 / 4 x PH2
- ⊕ 2 x PZ1 / 4 x PZ2 / 2 x PZ3
- ⊕ 2 x T10 / 3 x T15 / 3 x T20 / 3 x T25 / 3 x T30 / 2 x T40
- 1 x Bit holder magnetic extra strong magnet 1/4"

**TORX® 1/4" 13-pcs.**

SB 7947-Y505

Order-No.



41828

6

- ⊕ 2 x T10 / 2 x T15 / 3 x T20 / 2 x T25 / 2 x T30 / 1 x T40
- 1 x Bit holder magnetic extra strong magnet 1/4"

**Phillips, Pozidriv, TORX®, 13-pcs., 1/4"**

SB 7947-Y904

Order-No.



41827

6

- ⊕ 2 x PH2
- ⊕ 1 x PZ1 / 2 x PZ2 / 1 x PZ3
- ⊕ 1 x T10 / 1 x T15 / 1 x T20 / 1 x T25 / 1 x T30 / 1 x T40
- 1 x Bit holder magnetic extra strong magnet 1/4"







Bit set XLSelector Standard 25 mm



**Meets your requirements:** Robust and precise bits for general fastening in trade and industry. **Saves time:** Simple and quick recognition of profile sizes thanks to contrasting laser marking. **Increases your efficiency:** All standard 25 mm bits organised in a compact, space-saving design.









assorted 1/4" 31-pcs.

7948-005

Order-No.	
29417	5
	1 x 4,5 / 1 x 5,5 / 1 x 6,5
	2 x PH1 / 4 x PH2 / 1 x PH3
	2 x PZ1 / 5 x PZ2 / 1 x PZ3
	2 x T10 / 2 x T15 / 2 x T20 / 3 x T25 / 2 x T30 / 1 x T40
	1 x Bit holder magnetic, 58 mm 1/4"

assorted 1/4" 31-pcs.

7948-927

Order-No.	
29416	5
	1 x 0 / 1 x 1 / 1 x 2 / 1 x 3 / 1 x 4
	1 x 4 / 1 x 6 / 1 x 8 / 1 x 10
	1 x TR2,0 / 1 x TR2,5 / 1 x TR3,0 / 1 x TR4,0 / 1 x TR5,0 / 1 x TR6,0
	1 x 6 / 1 x 8 / 1 x 10
	1 x T8H / 1 x T9H / 1 x T10H / 1 x T15H / 1 x T20H / 1 x T25H / 1 x T27H / 1 x T30H / 1 x T40H
	1 x #1 / 1 x #2 / 1 x #3
	1 x Bit holder CentroFix Force mechanically lockable 1/4", magnetisch







Bit set FlipSelector Standard 25 mm



**Meets your requirements:** Robust and precise bits for general fastening in trade and industry. **Simplifies your work:** Simple and rapid bit removal thanks to clear organisation and automatic opening at the push of a button. **Saves time:** Simple and quick recognition of profile sizes thanks to contrasting laser marking.





assorted 1/4" 13-pcs.

7947-999

Order-No.	
39078	10
	1 x 5,5
	1 x PH2
	1 x PZ1 / 1 x PZ2 / 1 x PZ3
	1 x T15 / 1 x T20 / 1 x T25 / 1 x T30
	1 x 3,0 / 1 x 4,0 / 1 x 5,0
	1 x Bit holder magnetic, 58 mm 1/4"





Slotted, Phillips, Pozidriv 1/4" 13-pcs.

7947-005

Order-No.	
39029	10
	1 x 5,5
	1 x PH1 / 3 x PH2 / 1 x PH3
	1 x PZ1 / 4 x PZ2 / 1 x PZ3
	1 x Bit holder magnetic, 58 mm 1/4"





Phillips, Pozidriv, TORX®, 13-pcs., 1/4"

7947-904

Order-No.	
39040	10
	2 x PH2
	1 x PZ1 / 2 x PZ2 / 1 x PZ3
	1 x T10 / 1 x T15 / 1 x T20 / 1 x T25 / 1 x T30 / 1 x T40
	1 x Bit holder magnetic, 58 mm 1/4"

Pozidriv, TORX® 1/4" 13-pcs.

7947-905

Order-No.	
39041	10
	1 x PZ1 / 2 x PZ2 / 1 x PZ3
	1 x T10 / 1 x T15 / 2 x T20 / 2 x T25 / 1 x T30 / 1 x T40
	1 x Bit holder magnetic, 58 mm 1/4"

**TORX® 1/4" 13-pcs.**

7947-505

Order-No.



39124

10

● 1 x T7 / 1 x T8 / 1 x T9 / 1 x T10 / 2 x T15 / 2 x T20 /  
2 x T25 / 1 x T30 / 1 x T40

○ 1 x Bit holder magnetic, 58 mm 1/4"

**TORX® Tamper Resistant (with hole) 1/4" 13-pcs.**

7947-505TR

Order-No.



39037

10

● 1 x T7H / 1 x T8H / 1 x T9H / 1 x T10H / 2 x T15H /  
2 x T20H / 2 x T25H / 1 x T30H / 1 x T40H

○ 1 x Bit holder magnetic, 58 mm 1/4"

**Hexagon 1/4" 11-pcs.**

7947-902

Order-No.



39039

10

● 1 x 1,5 / 1 x 2,0 / 1 x 2,5 / 2 x 3,0 / 2 x 4,0 / 1 x 5,0 /  
1 x 6,0 / 1 x 8,0

○ 1 x Bit holder magnetic, 58 mm 1/4"

**SIT (for Assy® and Pias screws), 13-pcs., 1/4"**

7947-995

Order-No.



39045

10

● 2 x SIT 10 / 4 x SIT 20 / 3 x SIT 25 / 2 x SIT 30 / 1 x SIT 40

○ 1 x Bit holder magnetic, 58 mm 1/4"

**High-performance offset screwdriver with quick release holder 1/4"**



**Increases your safety:** Variably settable stabiliser arm. **Increases your efficiency:** Unlimited access to hard-to-reach screws thanks to the 105°-angled tool head.

**○ 1/4" in blister pack**

24628

Order-No.



max.  
Nm



32310

1/4

1/4

165

57

1

Perfect order when fast work is required.





Perfect order and easy handling - the ErgoStar L-key holder provides both: Rotating a single L-key in the holder means that all other keys rotate at the same angle! Keys sitting next to each other no longer need to be disentangled. Instead, all keys are ready for removal with one turn - as fast and easy as never before. The keys of the ErgoStar also help to make work significantly easier: The Wiha L-key set of the 369R series, made of fully hardened chrome vanadium steel, includes an innovation that will convince everyone. A spring steel ring holds hexagon screws reliably.

- **Simplifies your work**  
The ball end facilitates access to screws and allows you to work at an angle of up to 25°.
- **Increases your efficiency**  
Wiha MagicRing® retaining function holds all screws firmly in place – without any magnets.
- **Facilitates handling**  
Always the correct key when you need it.
- **Saves time**  
Ensures order: removing and targeted insertion in the holder is child's play.



## L-key set in ErgoStar holder

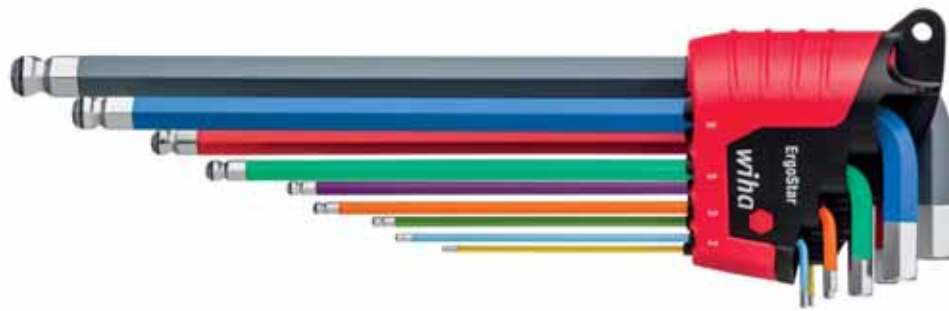

**Simplifies your work:** The ball end facilitates access to screws and allows you to work at an angle of up to 25°. **Lowers your costs:** Reduces the risk of forgetting and leaving keys inside a machine and causing damage. **Facilitates handling:** Always the right key in the right place with the ErgoStar holder. **Increases your efficiency:** Coloured L-keys quick and easy to find – also in dark environments thanks to fluorescent paint visible in UV light. The required key width can be quickly found thanks to colour coding. Wiha MagicRing® holding feature holds all hex screws in place without a magnet.

## hexagonal ball Magicring® 9-pcs. in flourescent colour

369RF

Order-No.

41979



5

● 1,5 / 2 / 2,5

● 3 / 4 / 5 / 6 / 8 / 10

MagicRing® from size 3 mm. Based on ISO 2936L.

### INFOBOX: Tools in fluorescent colour



- Coloured bits and ErgoStar with coloured L-keys light up under a UV light.
- Ensuring misplaced tools are quickly and easily found again.
- The Wiha flashlight with a UV light makes the perfect complement to coloured fluorescent tools.

## L-key set in ErgoStar holder



Fastening/jamming

**Simplifies your work:** The ball end facilitates access to screws and allows you to work at an angle of up to 25°. **Lowers your costs:** Highly durable thanks to high-quality, chrome-plated L-key surface to prevent corrosion. **Facilitates handling:** Always the correct key when you need it. **Saves time:** Ensures order: removing and targeted insertion in the holder is child's play. **Increases your efficiency:** Wiha MagicRing® holding feature holds all hex screws in place without a magnet.

### Hexagonal ball end MagicRing® matt chrome-plated 9-pcs.

369R

Order-No.



37351

5

● 1,5 / 2 / 2,5

● 3 / 4 / 5 / 6 / 8 / 10

MagicRing® from size 3 mm. Based on ISO 2936L.

### INFOBOX: MagicRing®



#### Wiha MagicRing®

- Spring steel ring reliably holds hex screws in place
- An innovation, which will benefit each user.



L-key set in Compact holder

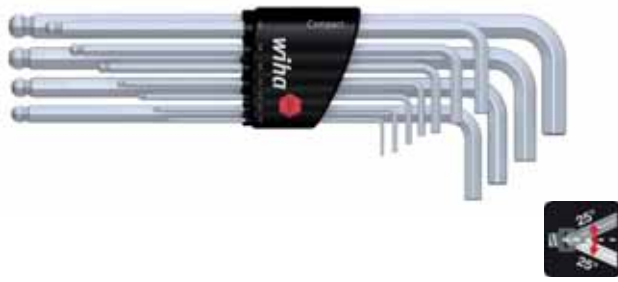

**Simplifies your work:** The ball end facilitates access to screws and allows you to work at an angle of up to 25°. **Lowers your costs:** Highly durable thanks to high-quality, chrome-plated L-key surface to prevent corrosion. **Saves space:** All standard keys organised in a compact, space-saving design.

Hexagonal ball end matt chrome-plated 11-pcs.

369

Order-No.	
36453	5
	1,5 / 2 / 2,5 / 3 / 4 / 5 / 6 / 7 / 8 / 9 / 10
Including 7 mm and 9 mm special sizes. Based on ISO 2936L.	

L-key set in ErgoStar holder



**Simplifies your work:** The ball end facilitates access to screws and allows you to work at an angle of up to 25°. **Facilitates handling:** Always the correct key when you need it. **Saves time:** Ensures order: removing and targeted insertion in the holder is child's play.

TORX® ball end, 13-pcs., black oxidised

366BE

Order-No.	
36487	5
	T5 / T6 / T7 / T8
	T9 / T10 / T15 / T20 / T25 / T27 / T30 / T40 / T45
TORX® ball end from size T9	

L-key set in Compact holder



**Simplifies your work:** The ball end facilitates access to screws and allows you to work at an angle of up to 25°. **Lowers your costs:** Highly durable thanks to high-quality, chrome-plated L-key surface to prevent corrosion. **Saves space:** All standard keys organised in a compact, space-saving design.

Hexagonal ball end matt chrome-plated 9-pcs.

369

Order-No.	
01418	5
	1,5 / 2 / 2,5 / 3 / 4 / 5 / 6 / 8 / 10
Based on ISO 2936L.	

INFOBOX:  
TORX® ball end



Wiha TORX® ball end

- With optimised TORX® ball end geometry
- Increased strength thanks to the special cold forming on a system developed by Wiha especially for this purpose.
- Allows fastening and unfastening at angles up to 25°.
- Simple insertion of the tool/bit and fastening/unfastening, especially in hard-to-reach positions.
- Broad product range: As an L-key, as a bit and as a SoftFinish® screwdriver.

INFOBOX:  
Ball end hex



Wiha hexagonal ball end

- The ball end can be rotated by up to 25° in both clockwise and anti-clockwise direction.



Screw extractor set



**Increases your efficiency:** Thread-conserving removal of the screw without damage.

Hexagon with spiral drill bit 8-pcs.

405 11

Order-No.



03988

10

● 2,0 / 2,5 / 3,0 / 4 / 5 / 6 / 8 / 10



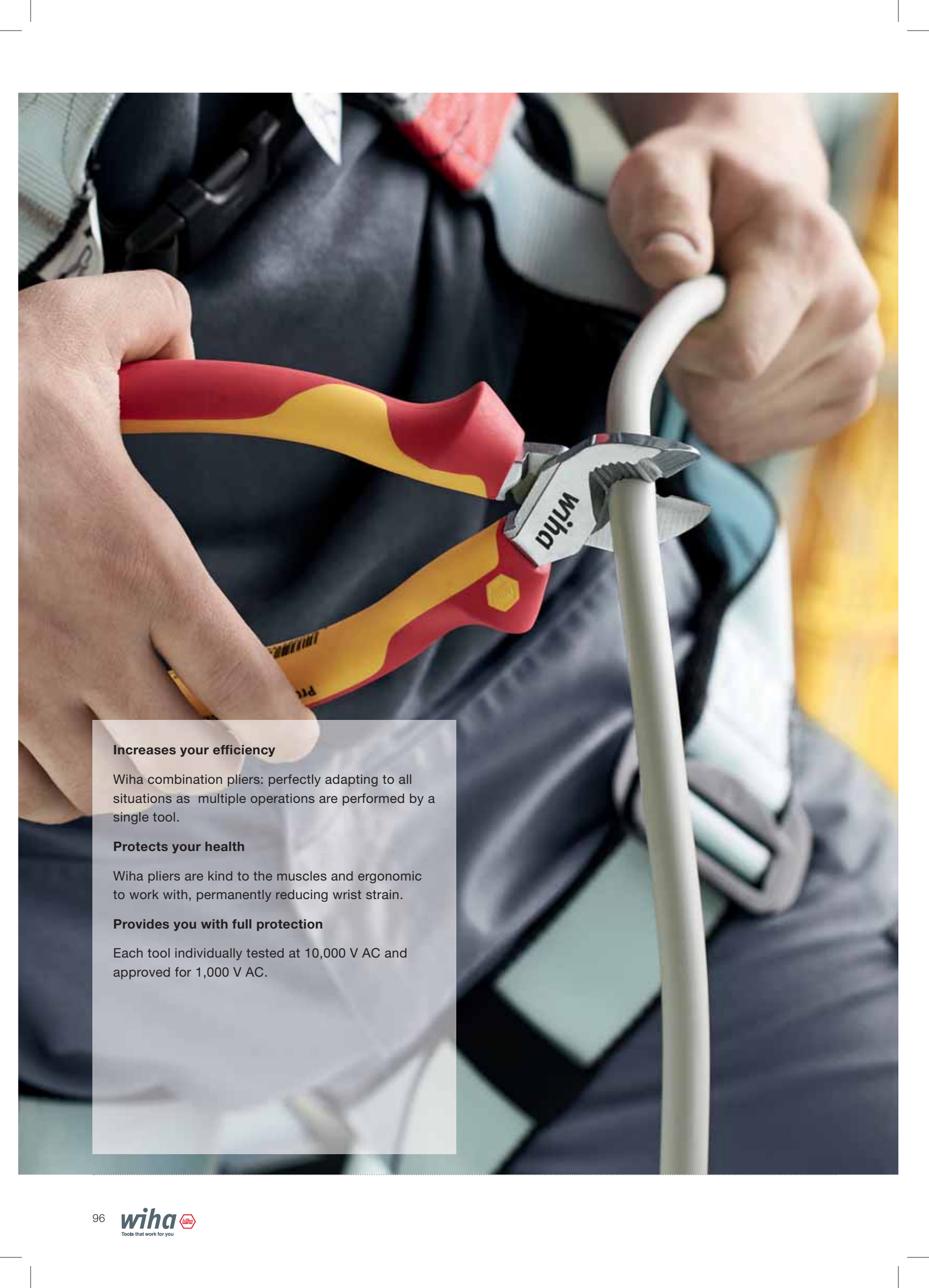

**Increases your efficiency**

Wiha combination pliers: perfectly adapting to all situations as multiple operations are performed by a single tool.

**Protects your health**

Wiha pliers are kind to the muscles and ergonomic to work with, permanently reducing wrist strain.

**Provides you with full protection**

Each tool individually tested at 10,000 V AC and approved for 1,000 V AC.

## Trimming / cutting

### A cut above the rest with Wiha.

A precise cut at the right time – no problem for Wiha diagonal cutters, heavy-duty diagonal cutters, cable cutters, cable shears and combination pliers. With the perfect combination of high-quality materials and ergonomic comfort, Wiha VDE-tools withstand the toughest demands. Production is in accordance to the state-of-the-art quality management guidelines. A special heat treatment and inductive hardening of the parts under high stress ensure a long lifespan. The precise interaction of the joints and the exacting quality workmanship of the blades and gripping surfaces ensure the highest level of functionality.

All Wiha products have been designed according to the latest findings in ergonomics. Ergonomic handles and well thought-out soft and hard zone distribution makes for work that protects the hands from strain and is comfortable.

Trimming/ cutting

**"With BiCut<sup>®</sup>, I always have sufficient power when cutting - and without aching fingers."**

Timo Schweitzer



**Double your power at the push of a button.**





Precise and safe work – at double the power: no problem for the Wiha BiCut® Professional electric diagonal cutters. If there is not enough power when cutting, or if cutting is laborious, a simple push of a button is all that is required and the cutting power is doubled. Another push of the button, and the power is halved again – easy! This significantly reduces the risk of cramp or slippage when applying too much force. The extra-wide back for the handle, with perfectly distributed soft and hard zones, ensures the optimum ergonomics. The new Wiha BiCut® has already been awarded with the “reddot award 2014 winner” for outstanding design quality. Doubles the power at the press of a button

- **Increases your efficiency**

Two pliers in one - 200 % power at the touch of a button, available at any time.

- **Protects your health**

Requires less force and reduces pressure on the wrists.

- **Provides you with full protection**

Each tool individually tested at 10,000 V AC and approved for 1,000 V AC.

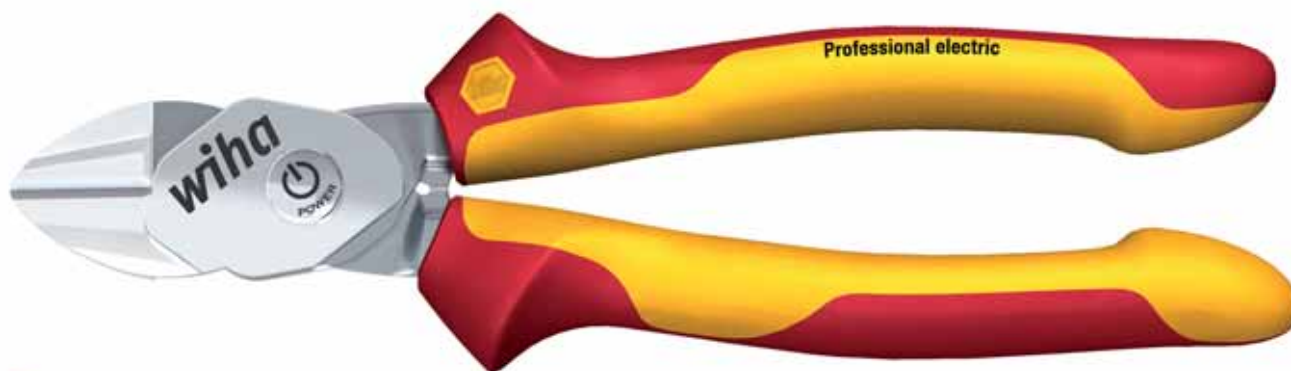



**Lowers your costs:** Durable thanks to high-quality, chrome-plated plier surface to prevent corrosion. **Protects your health:** Requires less force and reduces pressure on the wrists. **Increases your efficiency:** Two pliers in one - 200 % power at the touch of a button, available at any time. **Provides you with full protection:** Each tool individually tested at 10,000 V AC and approved for 1,000 V AC.



**Switchable**

Z 18 0 06

Order-No.	↔ mm	↔ II	✂	Ø mm
38191	200	8	21	3



Manufactured acc. to IEC 60900.

**INFOBOX:  
Safety note**



- When working with cutting pliers - beware of wire ends flying off. Please wear safety glasses.

**INFOBOX:  
Cutting capacity info**

✂	Example
1 - 5	copper, aluminium
6 - 10	Iron nails
11 - 15	Screws
16 - 21	Hardened spring steel



**Lowers your costs:** Durable thanks to high-quality, chrome-plated plier surface to prevent corrosion. **Increases your safety:** Wiha combination pliers enable safe, non-slip gripping in all work situations. **Protects your health:** Special DynamicJoint® design reduces effort required for cutting. **Increases your efficiency:** Wiha needle nose pliers with extra-long plier head for inserting low-lying components. **Provides you with full protection:** Each tool individually tested at 10,000 V AC and approved for 1,000 V AC.

Trimming/ cutting

**Combination pliers, needle nose pliers, diagonal cutters 3-pcs.**

Z 99 0 001 06

Order-No.



26852

1

**Trimming / cutting**

Professional electric diagonal cutters with DynamicJoint®, Tool tested at 10,000 V AC / 160mm, 6 1/2" (26741)

**Supplying / holding**

Combination pliers Professional electric with DynamicJoint® and OptiGrip with extra long cutting edge, Tool tested at 10,000 V AC / 180mm, 7" (26708)

Needle nose pliers Professional electric with cutting edge straight shape, Tool tested at 10,000 V AC / 200mm, 8" (26727)

Manufactured acc. to IEC 60900.

Professional electric diagonal cutters with DynamicJoint®



**Lowers your costs:** Durable thanks to high-quality, chrome-plated plier surface to prevent corrosion. **Protects your health:** Special DynamicJoint® design reduces effort required for cutting. **Provides you with full protection:** Each tool individually tested at 10,000 V AC and approved for 1,000 V AC.

Z 12 1 06

Order-No.	mm	in	✂	Ømm	
43326	140	5 1/2"	16	1,6	5
43335	160	6 1/2"	17	2	5
43340	180	7"	18	2,3	5

Manufactured acc. to IEC 60900.

Heavy-duty diagonal cutters Professional electric with DynamicJoint®



**Simplifies your work:** Up to 40% more cutting force thanks to optimised leverage. **Lowers your costs:** Durable thanks to high-quality, chrome-plated plier surface to prevent corrosion. **Protects your health:** Special DynamicJoint® design reduces effort required for cutting. Reduces strain from continuous work thanks to opening spring. **Provides you with full protection:** Each tool individually tested at 10,000 V AC and approved for 1,000 V AC.

with switchable opening spring

Z 16 3 06

Order-No.	mm	in	✂	Ømm	
40921	160	6,5	17	2	5
41274	180	7	18	2,3	5
41279	200	8	19	2,5	5

DIN ISO 5749. Manufactured acc. to IEC 60900.

INFOBOX:  
DynamicJoint®



Wiha DynamicJoint® – A new dimension in strength and durability

- Innovative: Optimised joint construction.
- Effective: Minimal power loss means less force needed for cutting.
- Permanent: Optimal performance even after thousands of cuts.

INFOBOX:  
Heavy-duty diagonal cutters



with switchable opening spring

- Up to 40% more cutting force thanks to optimised leverage.
- Opening spring with on/off function for fatigue-free work.
- Opening spring can be activated with just one hand.



### Cable cutter Professional electric



**Lowers your costs:** Durable thanks to high-quality, chrome-plated plier surface to prevent corrosion. **Increases your efficiency:** Clean work thanks to cable cutting without crushing. **Provides you with full protection:** Each tool individually tested at 10,000 V AC and approved for 1,000 V AC.

Z 50 1 06

Order-No.	mm	II	Scissors	mm <sup>2</sup>	Stack
34743	160	6 ½	16	50	5
34744	200	8	20	60	5

Manufactured acc. to IEC 60900.

### High-leverage combination pliers Professional electric with DynamicJoint® and OptiGrip



**Simplifies your work:** Up to 40% more cutting force thanks to optimised leverage. **Lowers your costs:** Durable thanks to high-quality, chrome-plated plier surface to prevent corrosion. **Protects your health:** Special DynamicJoint® design reduces effort required for cutting. **Increases your efficiency:** A secure, non-slip grip in all standard work situations. **Provides you with full protection:** Each tool individually tested at 10,000 V AC and approved for 1,000 V AC.

#### with extra long cutting edge

Z 02 0 06

Order-No.	mm	II	Scissors	Ømm	Stack
26714	200	8	18	2.3	5
26717	225	9	19	2.5	5

DIN ISO 5746. Manufactured acc. to IEC 60900.

### Combination pliers Professional electric with DynamicJoint® and OptiGrip



**Lowers your costs:** Durable thanks to high-quality, chrome-plated plier surface to prevent corrosion. **Protects your health:** Special DynamicJoint® design reduces effort required for cutting. **Increases your efficiency:** A secure, non-slip grip in all standard work situations. **Provides you with full protection:** Each tool individually tested at 10,000 V AC and approved for 1,000 V AC.

#### with extra long cutting edge

Z 01 0 06

Order-No.	mm	II	Scissors	Ømm	Stack
26705	160	6 ½	15	1.6	5
26708	180	7	16	1.8	5
26711	200	8	17	2	5

DIN ISO 5746. Manufactured acc. to IEC 60900.

### INFOBOX: OptiGrip

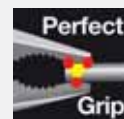

#### Wiha OptiGrip – optimal grip due to newly designed gripping surfaces

- A firm hold: The „triple-point support“ protects the workpiece from twisting or slipping.
- Highly effective: Optimum grip even with large jaw opening – and at the same time significantly less force needed.
- A wide selection: Now in standard Wiha combination pliers and high leverage combination pliers.

### Precision mechanic's diagonal cutters Classic



**Meets your requirements:** For almost flush cutting of soft and semi-hard wires. **Protects your health:** Reduced risk of injury thanks to smooth burr-free finished results, for example with cable ties.

#### with opening spring

Z 44 3 01

Order-No.	mm	II	✂	Ø mm	
36189	125	5	7	0.8	5

DIN ISO 5749.

### Plastic diagonal cutters Classic



**Meets your requirements:** For the smooth and flush cutting of plastics. **Protects your health:** Reduced risk of injury thanks to smooth burr-free finished results, for example with cable ties.

#### with opening spring without bevelled edge

Z 15 0 01

Order-No.	mm	II	✂	
37402	125	5	2	5

37403 160 6 ½ 3 5  
DIN ISO 5743.

### Shear for electricians



**Simplifies your work:** Large blade notch and micro-toothed cutting edge prevent the cable from slipping out of the shears. **Increases your safety:** Protective cover with retaining clip for safe carrying. **Facilitates handling:** The combination between a sturdy blade and an ergonomic handle with extra large handle holes enable users to make a flawless cut into cables up to 50 mm<sup>2</sup>. **Increases your efficiency:** Shear for electricians with stripping, skinning, crimping & cutting-to-length functions in a single tool.

#### with crimp function in blister pack

Z 71 7 06

Order-No.	mm	mm <sup>2</sup>	
41923	160	50	5

### Hacksaw electric



**Lowers your costs:** Durable and sturdy thanks to bimetallic saw blade. **Facilitates handling:** The ergonomic handle is suitable for both right- and left-handed users\* Using the plastic screw, the saw blade can be changed quickly and easily. **Increases your efficiency:** The fine-toothed saw blade allows a clean cut, for example on plastic pipes and metal cable ducts. **Provides you with full protection:** Each tool individually tested at 10,000 V AC and usable for 1,000 V AC.

#### insulated with three saw blades 150 mm

246176

Order-No.		mm	SB	
43125	150	280	x	1



Trimming/ cutting







**Increases your efficiency**

Wiha gripping pliers enable safe, non-slip gripping in all work situations.

**Lowers your costs**

With a special fastening feature in their tips, Wiha circlip pliers keep circlips sturdy and firmly in position, preventing damage in the working environment.

**Provides you with full protection**

Each tool individually tested at 10,000 V AC and approved for 1,000 V AC.



## Supplying / holding

### Supplying – completely relaxed.

In the supplying and holding working procedures, Wiha pliers prove to be clever helpers for relaxed and efficient work. For instance, the OptiGrip of the combination and high-leverage combination pliers ensure optimal and secure holding using an innovative gripping surface: The unique 'triple-point support' protects the work piece from twisting or slipping. The circlip pliers from the Classic Series with their MagicTips® precision tips made of high-performance steel offer considerable additional safety and stability. Their special latching function is especially useful against in preventing the circlips jumping off.

**“You only have to lose a circlip, and then you realize the benefits of Wiha pliers!”**

Frank Scheck



### Needle nose pliers Professional electric



**Lowers your costs:** Durable thanks to high-quality, chrome-plated plier surface to prevent corrosion. **Increases your efficiency:** Extra-long plier head for inserting low-lying components. **Provides you with full protection:** Each tool individually tested at 10,000 V AC and approved for 1,000 V AC.

#### with cutting edge straight shape

Z 05 0 06

Order-No.	mm	mm	mm	mm	
26720	160	6 ½	16	1.2	5
26727	200	8	17	1.6	5

DIN ISO 5745. Manufactured acc. to IEC 60900.

### Combination pliers Professional electric with DynamicJoint® and OptiGrip



**Lowers your costs:** Durable thanks to high-quality, chrome-plated plier surface to prevent corrosion. **Protects your health:** Special DynamicJoint® design reduces effort required for cutting. **Increases your efficiency:** A secure, non-slip grip in all standard work situations. **Provides you with full protection:** Each tool individually tested at 10,000 V AC and approved for 1,000 V AC.

#### with extra long cutting edge

Z 01 0 06

Order-No.	mm	mm	mm	mm	
26705	160	6 ½	15	1.6	5
26708	180	7	16	1.8	5
26711	200	8	17	2	5

DIN ISO 5746. Manufactured acc. to IEC 60900.

### Needle nose pliers Professional electric



**Lowers your costs:** Durable thanks to high-quality, chrome-plated plier surface to prevent corrosion. **Increases your efficiency:** Extra-long plier head for inserting low-lying components. **Provides you with full protection:** Each tool individually tested at 10,000 V AC and approved for 1,000 V AC.

#### with cutting edge curved shape, approx. 40°

Z 05 1 06

Order-No.	mm	mm	mm	mm	
26728	160	6 ½	16	1.2	5
26729	200	8	17	1.6	5

DIN ISO 5745. Manufactured acc. to IEC 60900.

### Water pump pliers Professional electric



**Meets your requirements:** Permanently stable through box joint with double guidance. **Lowers your costs:** Durable thanks to high-quality, chrome-plated plier surface to prevent corrosion. **Increases your efficiency:** Fast and simple adjustment of pliers with push button. **Provides you with full protection:** Each tool individually tested at 10,000 V AC and approved for 1,000 V AC.

#### with push button adjustment

Z 22 0 06

Order-No.	mm	mm	mm	mm	
37450	250	10	2	50	5

DIN ISO 8976. Manufactured acc. to IEC 60900.

**High-leverage combination pliers Professional electric with DynamicJoint® and OptiGrip**



**Simplifies your work:** Up to 40% more cutting force thanks to optimised leverage. **Lowers your costs:** Durable thanks to high-quality, chrome-plated plier surface to prevent corrosion. **Protects your health:** Special DynamicJoint® design reduces effort required for cutting. **Increases your efficiency:** A secure, non-slip grip in all standard work situations. **Provides you with full protection:** Each tool individually tested at 10,000 V AC and approved for 1,000 V AC.

**with extra long cutting edge**

Z 02 0 06

Order-No.	mm	II	✂	Ø mm	
26714	200	8	18	2.3	5
26717	225	9	19	2.5	5

DIN ISO 5746. Manufactured acc. to IEC 60900.

**Water pump pliers Professional electric**



**Meets your requirements:** Permanently stable through box joint with double guidance. **Lowers your costs:** Durable thanks to high-quality, chrome-plated plier surface to prevent corrosion. **Provides you with full protection:** Each tool individually tested at 10,000 V AC and approved for 1,000 V AC.

**box type**

Z 21 0 06

Order-No.	mm	II	⊙	⊙	
33520	250	10	2	50	5

DIN ISO 8976. Manufactured acc. to IEC 60900.

**Long flat-nose pliers Professional electric**



**Increases your efficiency:** Extra-long plier head for inserting low-lying components. **Provides you with full protection:** Each tool individually tested at 10,000 V AC and approved for 1,000 V AC.

Z 07 0 06

Order-No.	mm	II	
26732	160	6 ½	5

DIN ISO 5745. Manufactured acc. to IEC 60900.

**Long round-nose pliers Professional electric**



**Increases your efficiency:** Extra-long plier head for inserting low-lying components. **Provides you with full protection:** Each tool individually tested at 10,000 V AC and approved for 1,000 V AC.

Z 09 0 06

Order-No.	mm	II	
26735	160	6 ½	5

DIN ISO 5745. Manufactured acc. to IEC 60900.

Supplying/ holding

### Inomic® electric combination pliers



**Protects your health:** Ergonomic handling enables users to work longer whilst protecting muscles. **Provides you with full protection:** Each tool individually tested at 10,000 V AC and approved for 1,000 V AC.

Z 01 0 16

Order-No.	Typ	✂	Ømm	📦
33261	180	12	1.6	5

Manufactured acc. to IEC 60900.

### Pliers wrench Classic



**Simplifies your work:** Self-locking at AF 17 and above. Also suitable for left-handed users as operated without side push button. **Lowers your costs:** Minimises wear and prevents damage to sensitive surfaces thanks to smooth, parallel jaws and backlash-free handling. **Saves space:** Replaces a set of metric and imperial open-ended spanners. **Protects your health:** Compaction and bending tasks take minimum effort thanks to manual force increased tenfold. **Saves time:** Safe, rapid setting directly on the work piece with no need to press any buttons. Ratchet function allows users to fasten screws instantly with a simple glide. **Improved access:** Slender design thanks to button-free setting enables it to be used in confined working environments, minimising the risk of damage.

Z 25 0 01

Order-No.	↔mm	↔II	⚙	📦
40923	250	10	46	6

### Needle nose pliers Inomic® VDE



**Saves money:** Two tools in one for cutting to length and skinning. **Protects your health:** Ergonomic handling enables users to work longer whilst protecting muscles. **Provides you with full protection:** Each tool individually tested at 10,000 V AC and approved for 1,000 V AC.

Z 06 0 16

**with cutting edge and stripping points**

Order-No.	Typ	✂	Ø	📦
33259	160	12	1,6	5

Manufactured acc. to IEC 60900.

### INFOBOX: Plier wrench



- Required width setting directly on the work piece with no need to press any buttons
- Ratchet principle allows users to fasten screws rapidly with a simple glide.
- Thanks to its slim design and button-free setting, it is ideal for use in tight spaces.
- Smooth, parallel-acting jaws prevent damage on sensitive surfaces.





Supplying/ holding

For those situations where a good grip is essential.

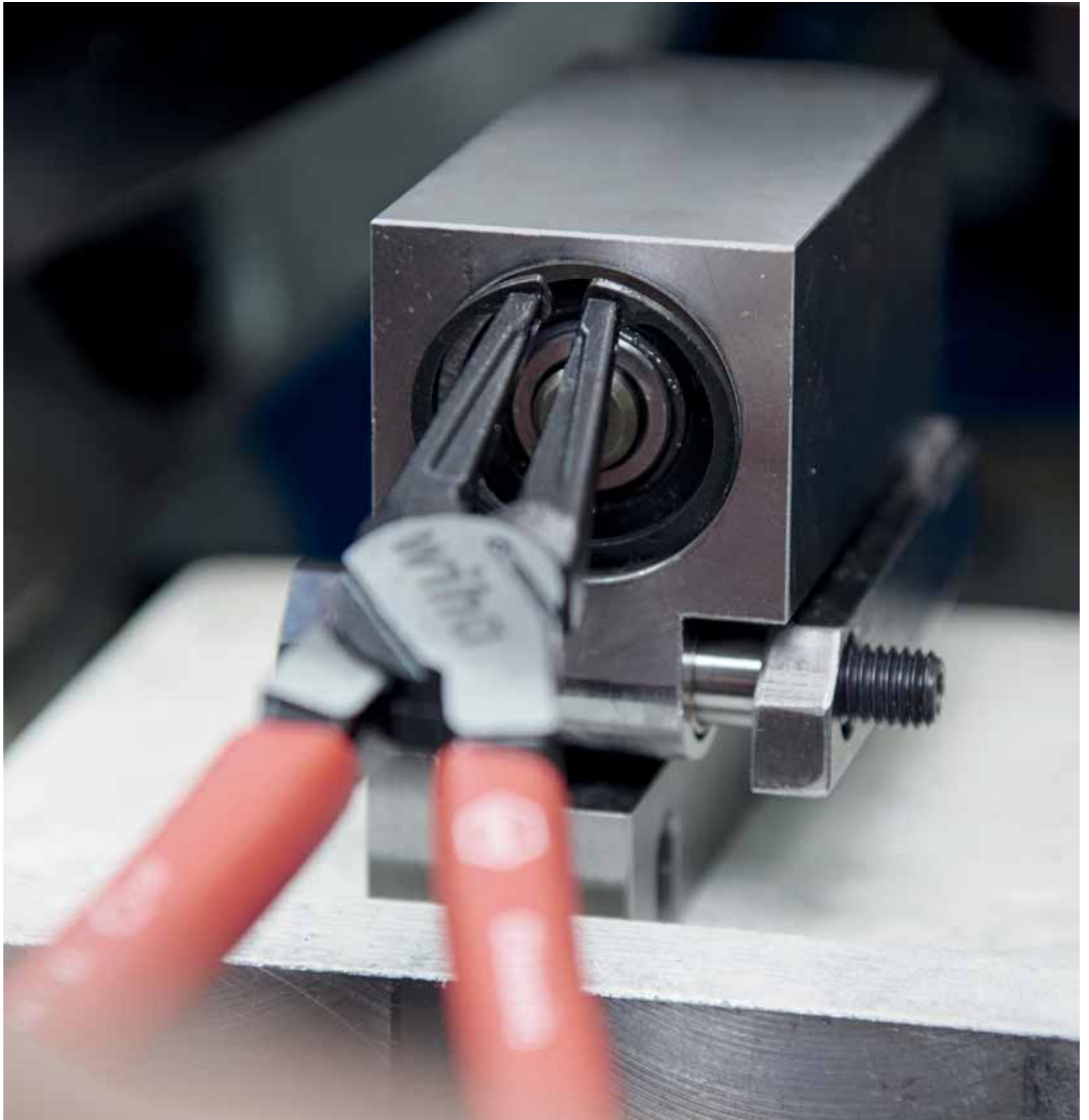

They make our circlip pliers for the Classic series head and shoulders above the rest: MagicTips®, the precision tips made of high-performance steel. Additionally hardened, they offer a high level of resistance to wear and therefore ensure a long shelf-life. The special latching feature is as unique as it is useful, and prevents jumping of the circlips - and therefore any reworking in the motor or working space caused by lost circlips. And thanks to the non-slip pliers handle, precise work is also guaranteed in unfavourable situations. Hard as nails, durable, safe, accurate: These qualities make Wiha MagicTips® circlip pliers useful and indispensable helpers during day-to-day work.

- **Lowers your costs**  
Prevents damage caused by lost circlips in the work area.
- **Saves time**  
Safe and sturdy grip on circlips.

Supplying/ holding



## Pliers set Classic with MagicTips®



**Lowers your costs:** Prevents damage caused by lost circlips in the work area. **Saves time:** Safe and sturdy grip on circlips.

### Circlip pliers 4-pcs.

Z 99 0 007 01

Order-No.



34708

1

### Supplying / holding

○ Circlip pliers Classic with MagicTips® For inner rings (drill holes) J 1, 140mm (34689) / J 2, 180mm (34690)

○ Circlip pliers Classic with MagicTips® For outer rings (shafts) A 1, 140mm (34699) / A 2, 185mm (34700)

• with safety latching function

### INFOBOX: MagicTips®



#### Wiha MagicTips® – Top of their class.

- Maximum grip: The special latching function preventing jumping away of the safety rings makes the Wiha circlip pliers truly unique.
- Hard as steel: Additional hardening of tips means high wear resistance and therefore excellent durability.
- Precise: Precision tips of high performance steel for maximum grip and high stability.



Classic circlip pliers with MagicTips®, straight



**Lowers your costs:** Prevents damage caused by lost circlips in the work area. **Saves time:** Safe and sturdy grip on circlips.

For inner rings (drill holes)

Z 33 4 01

Order-No.	Typ	mm	II	⊙	
34688	J 0	140	5 ½	8-13	5
34689	J 1	140	5 ½	12-25	5
34690	J 2•	180	7	19-60	5
34691	J 3•	220	9	40-100	5
34692	J 4•	305	12	85-140	5

• with safety latching functionDIN ISO 5256.

Classic circlip pliers with MagicTips®, angled



**Lowers your costs:** Prevents damage caused by lost circlips in the work area. **Saves time:** Safe and sturdy grip on circlips.

For inner rings (drill holes)

Z 33 5 01

Order-No.	Typ	mm	II	⊙	
34693	J 01	140	5 ½	8-13	5
34694	J 11	140	5 ½	12-25	5
34695	J 21•	180	7	19-60	5
34696	J 31•	220	9	40-100	5
34697	J 41•	305	12	85-140	5

• with safety latching functionDIN ISO 5256.

Classic circlip pliers with MagicTips®, straight



**Lowers your costs:** Prevents damage caused by lost circlips in the work area. **Saves time:** Safe and sturdy grip on circlips.

For outer rings (shafts)

Z 34 4 01

Order-No.	Typ	mm	II	⊙	
34698	A 0	140	5 ½	7-10	5
34699	A 1	140	5 ½	10-25	5
34700	A 2•	185	7	19-60	5
34701	A 3•	240	9	40-100	5
34702	A 4•	300	12	85-140	5

• with safety latching functionDIN ISO 5254.

Classic circlip pliers with MagicTips®, angled



**Lowers your costs:** Prevents damage caused by lost circlips in the work area. **Saves time:** Safe and sturdy grip on circlips.

For outer rings (shafts)

Z 34 5 01

Order-No.	Typ	mm	II	⊙	
34703	A 01	140	5 ½	7-10	5
34704	A 11	140	5 ½	10-25	5
34705	A 21•	185	7	19-60	5
34706	A 31•	240	9	40-100	5
34707	A 41•	300	12	85-140	5

• with safety latching functionDIN ISO 5254.

Supplying/ holding



#### **Protects your health**

Wiha pliers are kind to the muscles and ergonomic to work with, permanently reducing wrist strain.

#### **Lowers your costs**

Thanks to the integration and combination of several operations in one tool, this removes the need for several tools.

#### **Provides you with full protection**

Each tool individually tested at 10,000 V AC and approved for 1,000 V AC.

## Stripping/ insulating / crimping For tidy cable ends.

It is particularly important to have an exacting, process-reliable approach when crimping to prevent fiddly wire-end sleeves snagging or twisting all the time. Wiha crimping tools guarantee a clean, precise crimping of components. The worker's pressure force is automatically adjusted. Only slight hand strength is required thanks to optimum transmission. These tools are suitable for handling a whole variety of components, from cable eyes and contacts through to male blade connectors. The automatic electric crimping pliers particularly impress with a feed and automatic adjustment to the wire-end sleeve size. Hexagonal crimping prevents wire-end sleeves from twisting in the pliers.

**"The automatic crimping pliers allow me to do my work much more quickly without the fiddly wire-end sleeves snagging or twisting all the time."**

Ralf Flaig



Stripping/ insulating/  
crimping



Three functions – one tool.





Less tools means less weight, better handling and more efficient work. The Wiha Professional electric TriCut installation pliers combine three tools in one, ideal for the three operations cutting-to-length, stripping and skinning. And it does all this while saving you energy: Due to an ergonomically shaped, specifically angled plier head forged from high-quality steel. The low-wear, inlaid joint with heavy-duty riveting makes the pliers particularly robust and durable, and production and testing according to IEC 60900, VDE/ GS certification and individual piece testing at 10,000 V AC ensures uncompromising safety.



- **Simplifies your work**

The angled shape of the head allows work to be performed in hard-to-reach spaces such as installation boxes.

- **Increases your efficiency**

Three tools in one. Saves 60% volume and 50% less weight for 100% efficiency.

- **Lowers your costs**

Now you only need one tool for three tasks: cutting to length, stripping and skinning.

- **Provides you with full protection**

Each tool individually tested at 10,000 V AC and approved for 1,000 V AC.



Stripping/insulating/  
crimping

### Installation pliers TriCut Professional electric



**Simplifies your work:** The angled head allows you to work in hard-to-reach places such as installation sockets. **Lowers your costs:** Durable thanks to high-quality, chrome-plated plier surface to prevent corrosion. **Saves money:** Now you only need one tool for three tasks: cutting to length, stripping and skinning. **Increases your efficiency:** Three tools in one. Saves 60% volume and 50% less weight for 100% efficiency. **Provides you with full protection:** Each tool individually tested at 10,000 V AC and approved for 1,000 V AC.

Z 14 1 06

Order-No.	mm	II	✂	Ø mm
38552	170	7	13	1.6



Manufactured acc. to IEC 60900.

### Stripping diagonal cutters Professional electric with DynamicJoint®



**Lowers your costs:** Durable thanks to high-quality, chrome-plated plier surface to prevent corrosion. **Saves money:** Two tools in one for cutting to length and skinning. **Protects your health:** Special DynamicJoint® design reduces effort required for cutting. **Provides you with full protection:** Each tool individually tested at 10,000 V AC and approved for 1,000 V AC.

Z 14 0 06

Order-No.	mm	II	✂	Ø mm
26745	160	6 ½	13	1.6



DIN ISO 5749. Manufactured acc. to IEC 60900.

### Stripping pliers Professional electric



**Lowers your costs:** Durable thanks to high-quality, chrome-plated plier surface to prevent corrosion. **Protects your health:** Reduces strain from continuous work thanks to opening spring. **Increases your efficiency:** Skinning of several cross-sections due to wide variety of settings. **Provides you with full protection:** Each tool individually tested at 10,000 V AC and approved for 1,000 V AC.

Z 55 0 06

Order-No.	mm	II	Ø	mm <sup>2</sup>
26847	160	6 ½	5	10



DIN ISO 5743. Manufactured acc. to IEC 60900.

### INFOBOX: Cutting capacity info

✂	Example
1 - 5	copper, aluminium
6 - 10	Iron nails
11 - 15	Screws
16 - 21	Hardened spring steel

### Needle nose pliers Inomic® VDE



**Saves money:** Two tools in one for cutting to length and skinning.  
**Protects your health:** Ergonomic handling enables users to work longer whilst protecting muscles. **Provides you with full protection:** Each tool individually tested at 10,000 V AC and approved for 1,000 V AC.

### with cutting edge and stripping points

Z 06 0 16

Order-No.	Typ		Ø	
33259	160	12	1,6	5

Manufactured acc. to IEC 60900.

### Stripping tool



**Simplifies your work:** Perfect handling thanks to ergonomic handle shape. **Saves time:** Automatic setting from round to length cutting. **Increases your efficiency:** Stripping of all standard cross-sections through continuous setting.

### with self-rotating trailing blade

24622

Order-No.	mm	II	Ø mm	
35969	165	6½	4,0-28	1

### Stripping tool



**Simplifies your work:** Enables stripping in hard-to-reach places such as installation sockets.

### for round cable, in blister pack

24677

Order-No.	mm	II	mm <sup>2</sup>	SB	
36052	125	5	8-13	x	1

### Cable stripping knife



**Provides you with full protection:** Each tool individually tested at 10,000 V AC and approved for 1,000 V AC.

### straight cutting edge for round cables in blister pack

24680

Order-No.	mm	II	SB	
38798	200	8	x	1

Manufactured acc. to IEC 60900.

### Cable stripping knife



**Lowers your costs:** No damage to wire insulation through sliding shoe on tip.

### hooked blade with sliding shoe for round cable, in blister pack

24678

Order-No.	mm	II	SB	
36053	200	8	x	1

Manufactured acc. to IEC 60900.

### Stripping tool



**Simplifies your work:** Enables incremental cable stripping and skinning in hard-to-reach places such as installation sockets.

### for coaxial cable, in blister pack

24676

Order-No.	mm	II	mm <sup>2</sup>	SB	
36051	110	4¼	4,8-7,5	x	1

Stripping tool automatic



**Lowers your costs:** Long-lasting and robust thanks to metal blade insert. **Protects your health:** Damper enclosed for large cable cross-sections to reduce recoil and protect wrists. **Saves time:** Blades quickly exchanged by immediately available replacement blades in the handle. **Increases your efficiency:** Automatic stripping pliers for a wide range of cables between 0.03 and 16 mm<sup>2</sup>.

up to 16 mm<sup>2</sup> in blister pack

Z 57 0 06

Order-No.	mm	II	mm <sup>2</sup>	AWG	SB	
42062	200	8	0,03 - 16	32-5	x	1

Stripping tool automatic



**Simplifies your work:** Unrestricted access to hard-to-reach work areas thanks to extremely slim handle shape. **Saves money:** Two tools in one for cutting to length and skinning. **Increases your efficiency:** Damage-free stripping thanks to automatic adjustment to cable diameter.

up to 6 mm<sup>2</sup> in blister pack

24675

Order-No.	mm	II	mm <sup>2</sup>	AWG	SB	
36050	190	7 ½	0,2-6,0	24-10	x	1

Spare blade and gripping jaw set



for automatic stripping tool

Z 57 0 001 06K

Order-No.	
42162	1

INFOBOX:  
Stripping tool,  
automatic up to  
16mm<sup>2</sup>



- These pliers can handle a wide range of cables, thus combining two pairs of pliers in one.
- The supplied damper can be used to lessen recoil caused by larger cable gauges, such as those greater than 6 mm<sup>2</sup>, thus helping to protect wrists.
- Precise cutting to length thanks to adjustable longitudinal stop.
- Integrated hand protection along the cutting edge guards against injury.



**Automatic crimp tool**



**Lowers your costs:** An integrated lever enables users to interrupt the crimping process at any time to protect the pliers. **Increases your safety:** Safe work through feed aid prevents crimping the plastic cover of wire-end sleeves. **Facilitates handling:** Thanks to hexagonal crimping, small wire-end sleeves no longer get caught. **Increases your efficiency:** Automatic adjustment of wire-end sleeve size with suitable crimping force for a large coverage area of 0.08-16mm<sup>2</sup>.

**for wire-end sleeves hex crimping**

Z 62 0 06

Order-No.	mm	mm <sup>2</sup>	AWG	
41246	210	0,08-16	28-5	1

For processing twin sleeves and wire-end sleeves with or without insulating collar as per DIN 46228 & EN 50027

**Crimp tool**



**Increases your safety:** Safe working through automatic pressing adjustment.

**for insulated cable eyes and contacts**

Z 62 0 06

Order-No.	mm	mm <sup>2</sup>	AWG	
33841	220	0,5-6	20-10	1

For processing of red, blue and yellow isolated cable eyes, pin-end cable connectors, contact pins, contact pin sleeves, circular pins, circular pin sleeves, batch connectors and parallel connectors according to DIN 46234.

**Crimp tool**



**Increases your safety:** Safe working through automatic pressing adjustment.

**for wire-end sleeves**

Z 62 0 06

Order-No.	mm	mm <sup>2</sup>	AWG	
33844	220	0,14-16	26-5	1

For processing of wire-end sleeves with and without isolating collar according to DIN 46228, EN 50027.

**Crimp tool**



**Increases your safety:** Safe working through automatic pressing adjustment.

**for non-insulated cable eye with closed sleeve**

Z 62 0 06

Order-No.	mm	mm <sup>2</sup>	AWG	
33843	220	0,1-16	26-6	1

For processing of non-isolated contact pins and contact pin sleeves according to DIN 46247 for standardised, solderless electrical connections.

Stripping/insulating/  
crimping

Crimp tool



**Increases your safety:** Safe working through automatic pressing adjustment.

for non-insulated male blade connectors

Z 62 0 06

Order-No.	mm	mm <sup>2</sup>	AWG	
33842	220	0,25-6	24-10	1

For processing of non-isolated contact pins and contact pin sleeves according to DIN 46247 for standardised, solderless electrical connections.

Crimping pliers Professional electric



**Meets your requirements:** Safe pressing in marked trapezoidal/ semi-circular profiles. **Lowers your costs:** Durable thanks to high-quality, chrome-plated plier surface to prevent corrosion. **Provides you with full protection:** Each tool individually tested at 10,000 V AC and approved for 1,000 V AC.



Z 60 0 06

Order-No.	mm	mm	mm <sup>2</sup>	
35862	180	7	0,25-16	5

DIN ISO 5743. Manufactured acc. to IEC 60900.

Crimping pliers Professional electric



**Meets your requirements:** Safe pressing in marked trapezoidal/ semi-circular profiles. **Lowers your costs:** Durable thanks to high-quality, chrome-plated plier surface to prevent corrosion. **Provides you with full protection:** Each tool individually tested at 10,000 V AC and approved for 1,000 V AC.

Z 60 0 06

Order-No.	mm	mm	mm <sup>2</sup>	
35861	145	5 3/4	0,25-2,5	5

DIN ISO 5743. Manufactured acc. to IEC 60900.



Stripping/insulating/  
crimping

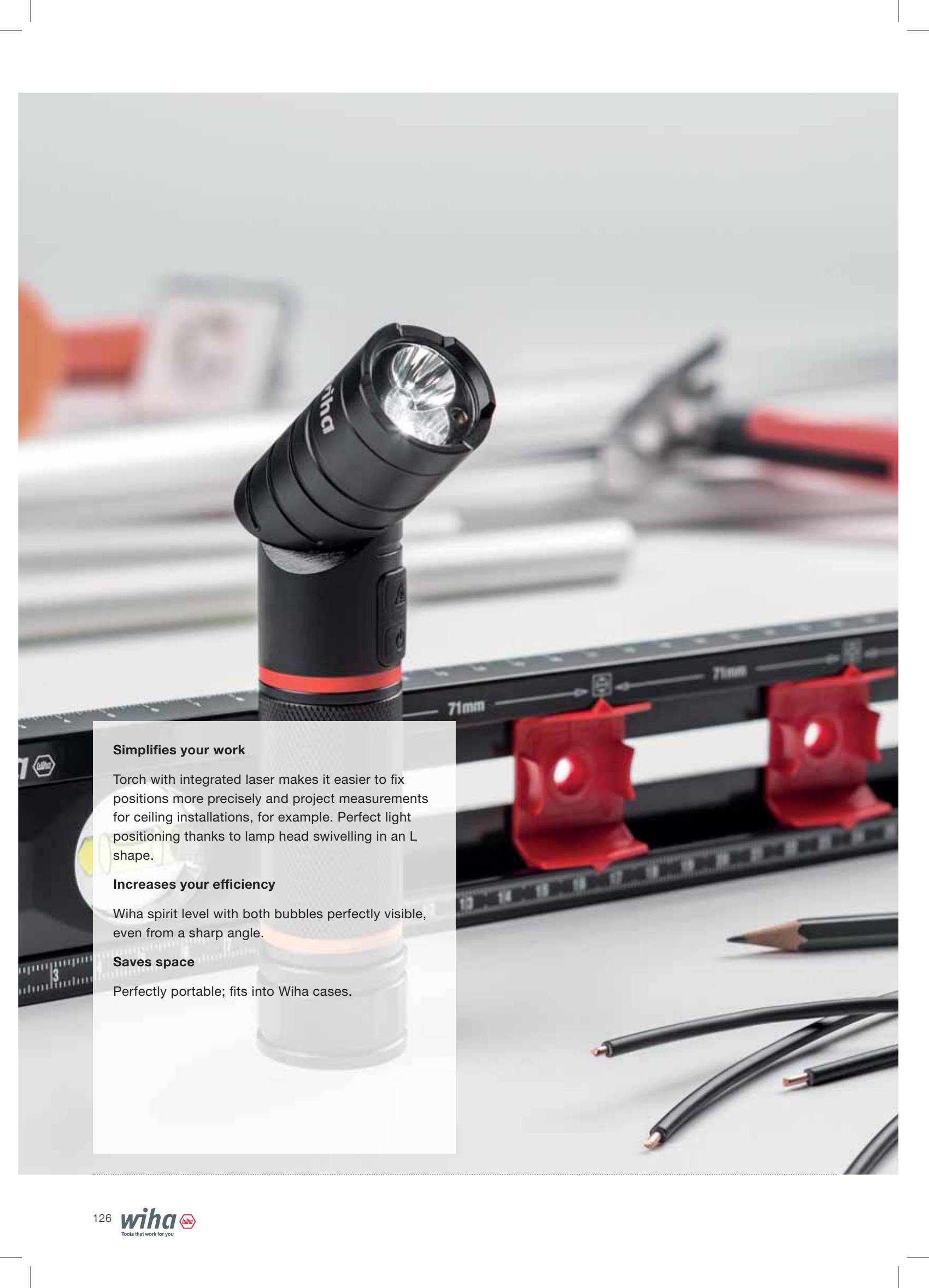

**Simplifies your work**

Torch with integrated laser makes it easier to fix positions more precisely and project measurements for ceiling installations, for example. Perfect light positioning thanks to lamp head swivelling in an L shape.

**Increases your efficiency**

Wiha spirit level with both bubbles perfectly visible, even from a sharp angle.

**Saves space**

Perfectly portable; fits into Wiha cases.



## Surveying/marketing/measuring/checking

### This is what we call precision work made to measure.

Wiha measurement and testing devices prove to be dependable helpers during electrical installation work. The multi-functional torch impresses in three ways thanks to its integrated laser, UV light and LED light with two lighting levels. With variable distance marks, the Wiha electrician's spirit level can reach across up to four flush boxes. Thanks to its ingeniously positioned scale, it allows users to make measurements effortlessly from different work positions. Users are guaranteed to see bubbles perfectly, even from a sharp angle. The Wiha electrician's folding ruler provides a scale for up to three flush boxes and edge distance marking at 150 mm. It can also be used to route cables into hard-to-reach installation locations. With its florescent coating, the folding ruler is also quick and easy to find in the dark with a UV light.

**"The Wiha spirit level is a big hit! I can see the bubbles perfectly even when taking measurements above my head. I can also mark out measurements without needing to take a break."**

Ralf Kästle



Surveying/ marking/  
measuring/ checking

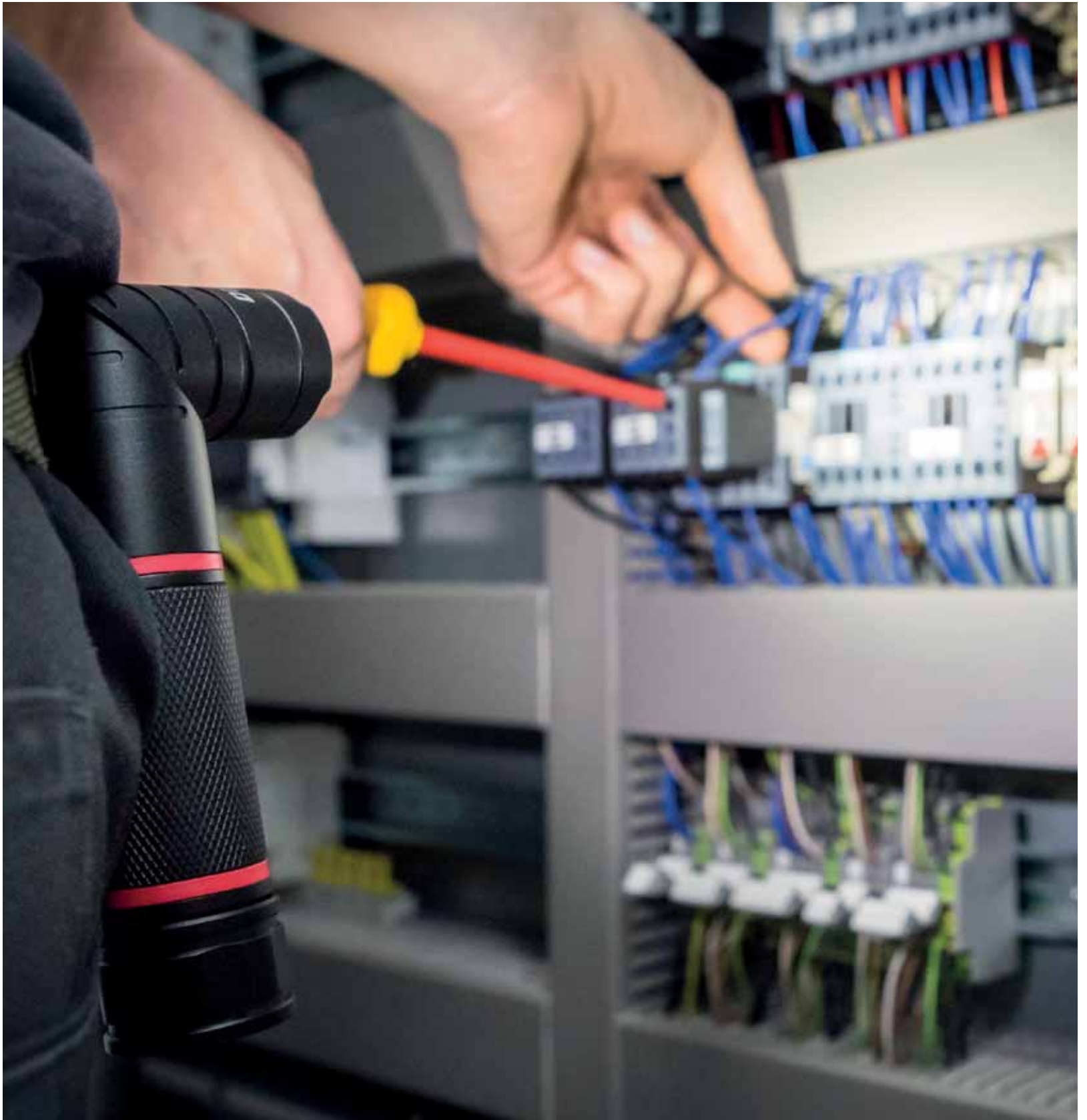

Even the most experienced professional tradesmen find it difficult to work efficiently in poorly lit work environments. The Wiha multi-functional torch sheds light on things in three ways: It features an integrated laser, UV light and LED light with two lighting levels. It is thus a compact, universal work tool which replaces several instruments in a single device. The integrated laser offers a great advantage, providing detailed positioning and easy transmission of measurements for tasks such as ceiling installations. This torch is even more practical for portable use thanks to the retaining clip, magnetic positioning and swivelling lamp head used to point the light in the required direction. Compact, light and multi-functional, the Wiha torch ensures optimum illumination for perfect vision and positioning.

- **Simplifies your work**  
Retaining clip and magnetic positioner on the lid allows you to keep hands free for other tasks.
- **Simplifies your work**  
Integrated laser makes it easier to fix position more precisely and project measurements for ceiling installations, for example. Perfect light positioning thanks to lamp head swivelling in an L shape.
- **Increases your efficiency**  
Very strong LED lamp – two light intensities to adjust to light conditions as required. Includes laser and UV light.
- **Increases your safety**  
Power-on time of 2 seconds prevents the laser being activated by accident.



Surveying/ marking/  
measuring/ checking

Flashlight with LED, laser and UV light



**Simplifies your work:** Retaining clip and magnetic positioner on the lid allows you to keep hands free for other tasks. Integrated laser makes it easier to fix position more precisely and project measurements for ceiling installations, for example. Perfect light positioning thanks to lamp head swivelling in an L shape. **Increases your safety:** Power-on time of 2 seconds prevents the laser being activated by accident. **Increases your efficiency:** Very strong LED lamp – two light intensities to adjust to light conditions as required. Includes laser and UV light.

in blister pack, including 3 AAA batteries

24670

Order-No.	LED	☼	UV	🔋	SB	
41286	100 / 310 lm	Class 2	390 - 400 nm	3 x AAA batteries	x	5

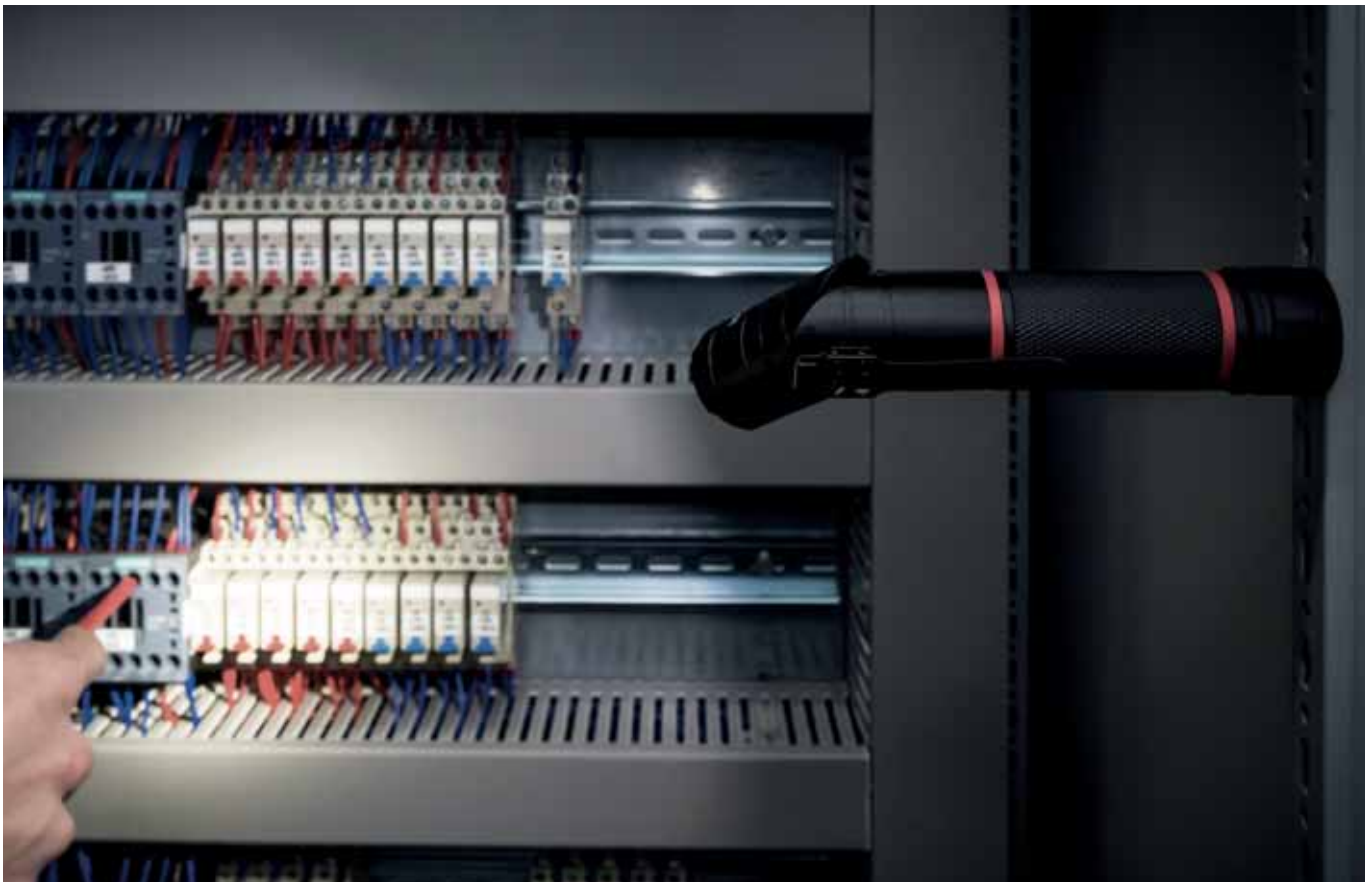



Torque QuickCheck torque testing device



**Increases your safety:** Checking your torque tool regularly guarantees safe, precise work with the correct torque. **Saves time:** LED traffic light system displays results in a way which is quick and easy to understand. **Increases your efficiency:** Fast, easy checking of your torque tool thanks to mobile, compact shape.

with adapter blades and batteries in box

2909

Order-No.	Nm	7/1%	SB
42086	2,8	2	x



Surveying/ marking/  
measuring/ checking

**Voltage tester Volt Detector non-contact, single-pole, 230-1,000 V AC**



**Simplifies your work:** Voltage tester operational at all times through automatic activation. **Increases your efficiency:** Fast voltage testing thanks to non-contact measurement within a field of 4mm.

Order-No.	●	mm		255-12
37871	4,2	149	10	
IEC 61010-1				

**Voltage tester SoftFinish® single-pole, 110-250 volts**



**Increases your efficiency:** Stable and as robust as a fully-fledged screwdriver. **Provides you with full protection:** Each tool individually tested at 10,000 V AC and approved for 1,000 V AC.

Order-No.	⊖		mm			255-11
34745	3,0	60	0,5	140	19	10
Tested according to DIN 57680-6, GS, CE compliant.						

**INFOBOX:  
Volt Detector**



**Testing pen for AC voltages.**

- Testing pen detects AC voltages of up to 230 V AC
- A bright red LED indicates AC voltages
- A current flow through the user's body is not necessary
- Complies with IEC 61010-1 safety standard: Measuring category CAT III 1,000 V
- Detects AC voltages within a field of 4 mm.
- CE compliant

**Electrician's Longlife® folding ruler, 2 m**



**Simplifies your work:** Integrated with cable retractor for cables between 3-7mm. **Lowers your costs:** Ruler quick and easy to find – even in dark environments with a UV light. **Increases your efficiency:** Ruler with integrated distance marks for up to 3 flush boxes. **Provides you with full protection:** Tool tested at 10,000 V AC and suitable for 1.000 V AC.

Order-No.				4102008
42068	15	orange	10	

**Folding ruler LongLife Plus Composite 2 m**



Order-No.				410 2005
37067	15	red/ black	10	

Electrician's spirit level



**Simplifies your work:** Comfortable measurement in different work positions thanks to the ingeniously positioned scales, even when viewed from above. **Saves space:** Perfectly portable; fits into Wiha cases. **Saves time:** Variable distance marks for up to 4 flush boxes. **Increases your efficiency:** Both bubbles can be seen easily even from an acute angle.

40 cm

246

Order-No.  $\longleftrightarrow$  mm



42074 400

10



Surveying/ marking/  
measuring/ checking





#### **Increases your efficiency**

Electrician's hammer offers perfect balance thanks to optimum weight distribution for effective handling.

#### **Saves time**

Dowel racket allows you to make dowel holes with the strike of a hammer anywhere at any time, even near power sockets.

#### **Increases the quality of your work**

The flat surface on the hammer handle ensures cables and dowels are fitted into position without causing any damage.



# Striking

## Optimum power transmission.

Specially tailored for use by electricians: Wiha impact tools. With optimally uniform weight distribution, the Wiha electric hammer strikes a perfect balance and is also eminently suitable for use in confined working environments. Its flat claws allow you to remove nails and nail clamps easily. The flat surface on the hammer handle ensures cables and dowels are fitted into position without causing any damage to the cable duct or plasterboard. Wiha's scaled impact screwdriver blade ensures that the portable dowel ratchet makes a perfectly dimensioned dowel hole to the required depth anywhere at any time and without making a mess, unlike power tools. The galvanic separation between the blade and solid steel cap ensures that the user is always protected, even if they accidentally hit a live wire.

**"Fits nicely into the hand and can be used in a variety of ways. It's now a permanent fixture in my toolbox!"**

Andreas Ebener



Striking/ chiselling



Thanks to its optimum balance, the electrician's hammer is perfectly sized in the hand while also providing a secure hold when hammering thanks to the ergonomically shaped hammer handle. With its U-shaped impact surface, the Wiha electrician's hammer delivers the optimum solution to working in corners and confined spaces. You can quickly and easily remove nails and nail clamps from walls with the flat claws on the hammer head. The flat surface on the hammer handle means cables and dowels are positioned effectively without causing any damage to the wall.

- **Simplifies your work**

Flat claws allow you to remove nails and nail clamps easily.

- **Increases your efficiency**

Perfect balance thanks to optimum weight distribution for effective handling.

- **Improved access**

Perfectly suited for use in confined working environments thanks to the combination of a square and round head shape.

- **Increases the quality of your work**

The flat surface on the hammer handle ensures cables and dowels are fitted into position without causing any damage.



Striking/ chiselling

## SoftFinish® dowel racket set with dowels



**Simplifies your work:** Dirt- and dust-free work compared to when machines are used. **Increases your safety:** Galvanic separation in the handle prevents a discharge between the striking cap and the blade.

**Protects your health:** Dowel hole can be made anywhere using a hammer at any time, even near power sockets. **Saves time:** Hammer dowel holes anywhere at any time without worrying how near you are to wall sockets. **Increases your efficiency:** Scaled impact screwdriver blade provides more detailed depth measurement. Perfectly dimensioned dowel hole thanks to blade adjusted to required size.

### Phillips with 6 mm round blade in blister pack, 5-pcs.

SB 534S5

Order-No.



41289

1

1 x Dowel racket

2 x 30 mm Dowel

2 x 40 mm Dübel

## Electrician's hammer



**Simplifies your work:** Flat claws allow you to remove nails and nail clamps easily. **Increases your efficiency:** Perfect balance thanks to optimum weight distribution for effective handling. **Improved access:** Perfectly suited for use in confined working environments thanks to the combination of a square and round head shape. **Increases the quality of your work:** The flat surface on the hammer handle ensures cables and dowels are fitted into position without causing any damage.

### with 300 g hammer head, in blister pack

846

Order-No.



42071

23,9 283

4

### INFOBOX: SoftFinish® dowel racket set with dowels



- Makes it easier to insert dowels and saves valuable working time.
- Ensures dirt- and dust-free work compared to machines.
- Galvanic separation between the blade and solid steel cap protects against electric shock.
- Perfect for portable use since you can make dowel holes anywhere at any time at the strike of a hammer.



### INFOBOX: Electrician's hammer



- With its optimally uniform weight distribution, this hammer ensures perfect balance, delivering impact and fatigue-free work.
- Its flat claws make it easier to remove fastening components such as nail clamps, even from difficult-to-access spots.
- Optimum access into corners and confined spaces thanks to U-shaped striking surface.
- The flat hammer handle lower surface acts as a soft-faced hammer, ensuring components such as cables and dowels are fixed into position without causing damage.



Subject to technical changes.

All illustrations and graphics, specified dimensions and values and references to standards, e.g. DIN/EN, are non-binding. Any liability claims based on this will therefore be rejected.

No liability claims will be accepted for printing errors and mistakes which have occurred during the production of the catalogue.

All property rights to the catalogue held by Wiha Werkzeuge GmbH are reserved. The printing or copying of the texts and illustrations contained in this catalogue or its design is prohibited.

Our General Terms and Conditions (Terms of Sale, Delivery and Payment) apply.

**TORX®**, **TORX PLUS®** = Registered Trademarks of ACUMENT Global Technologies B.V.

**ACR/AOT**, **Tri-Wing®**, **Torq-Set®** = Registered Trademarks of Phillips Screw Company

**Pozidriv** = Registered Trademark of European Industrial Services Ltd.

### Protective measures

The following equipment is required for all work on or around live components and should be appropriate for the specific task

- insulating personal protective equipment
- insulating safety mechanisms
- insulated tools

Before starting work, you must disconnect all active, live components of electrical machines and equipment and ensure that they remain disconnected while you carry out the work.

This is achieved by complying with the five safety rules:

- disconnect
- secure against reconnection
- ensure power is switched off
- earth and short-circuit
- cover or block off adjacent live components

# Wiha order number register

Order-No.	Page	Order-No.	Page	Order-No.	Page	Order-No.	Page
<b>00...</b>		00858	67	03760	66	23147	79
00684	75	00859	67	03761	66	23149	79
00685	75	00860	67	03762	66	23151	79
00686	75	00861	67	03988	95	23195	78
00687	75	00862	67	<b>04...</b>		23197	79
00689	75	00863	67	04009	77	23199	79
00690	75	00864	67	04010	77	23201	79
00691	75	00865	67	04059	77	23203	79
00692	75	00866	67	04126	77	23205	79
00694	75	00867	67	04127	77	23207	79
00695	75	00868	67	04176	77	23209	79
00696	75	00877	66	04194	79	23211	79
00697	75	00878	66	04195	79	23213	77
00698	75	00879	66	04196	79	23215	77
00700	75	00880	66	04197	79	23217	77
00701	75	00881	66	04198	79	23219	77
00702	75	00882	66	<b>05...</b>		23221	77
00703	75	<b>01...</b>		05301	79	23223	77
00704	75	01418	94	05302	79	23225	77
00706	75	01790	77	05303	79	23226	77
00707	75	01791	77	05799	77	23227	77
00708	75	01792	77	05800	77	23228	77
00709	75	01793	77	<b>06...</b>		<b>24...</b>	
00711	75	01794	77	06637	79	24867	79
00712	75	01795	77	06638	79	<b>25...</b>	
00713	75	01796	77	06639	79	25477	65
00819	66	01798	77	06888	77	25553	79
00820	66	01799	77	06889	77	25739	79
00821	66	01800	77	<b>20...</b>		25740	79
00822	66	01803	77	20218	79	25741	79
00823	66	01805	77	20219	79	25742	79
00824	66	01808	77	20220	79	<b>26...</b>	
00825	66	01809	77	20221	79	26000	78
00826	66	01811	77	20222	79	26002	78
00827	66	01812	77	20223	79	26625	37
00828	66	01913	76	20224	79	26626	37
00829	66	<b>03...</b>		<b>21...</b>		26627	37
00830	66	03223	74	21045	79	26705	103, 108
00831	66	03224	74	21047	79	26708	103, 108
00832	66	03225	74	<b>22...</b>		26711	103, 108
00833	65	03226	74	22509	77	26714	103, 109
00834	65	03228	74	22510	77	26717	103, 109
00846	66	03230	74	22511	77	26720	108
00847	66	03231	74	22512	77	26727	108
00848	66	03232	74	22596	79	26728	108
00849	66	03237	74	22597	79	26729	108
00850	66	03238	74	22598	79	26732	109
00853	67	03239	74	22599	79	26735	109
00855	67	03245	74	22600	79	26745	120
00856	67	03246	74	<b>23...</b>		26755	20
00857	67	03247	74	23145	79	26847	120

Order-No.	Page	Order-No.	Page	Order-No.	Page	Order-No.	Page
26852	101	32306	78	33708	77	33969	19
26864	37	32307	78	33709	78	<b>34...</b>	
26931	75	32308	78	33710	78	34306	76
<b>27...</b>		32309	78	33711	78	34452	78
27753	75	32310	89	33712	78	34453	78
27754	75	32383	75	33713	78	34454	78
27755	75	32384	75	33714	78	34455	78
27928	69	32396	66	33715	78	34456	78
27929	69	32397	66	33716	78	34457	78
27930	69	32399	75	33717	78	34554	79
27931	69	32400	75	33718	78	34555	79
27932	69	32409	78	33719	78	34556	79
27933	69	32410	78	33720	78	34557	79
27934	69	32411	78	33721	78	34558	79
27935	69	32412	78	33722	78	34559	79
<b>28...</b>		32413	78	33723	78	34560	79
28481	78	32414	78	33724	78	34578	43, 58
28691	47	32415	78	33725	78	34579	43, 58
<b>29...</b>		32416	78	33726	78	34580	43, 58
29416	88	32417	78	33727	78	34581	43, 58
29417	88	32418	78	33728	78	34582	43, 58
29466	67	32419	78	33729	78	34583	43, 58
<b>30...</b>		32421	78	33730	78	34584	43, 58
30361	66	32423	78	33731	78	34585	43, 58
30362	66	32477	76	33732	78	34586	43, 58
30363	66	32486	78	33736	80	34587	43, 58
30364	66	32490	77	33743	80	34588	43, 58
30365	66	32491	77	33764	80	34589	43, 58
30366	66	32492	77	33841	123	34590	43, 58
30700	66	32493	77	33842	124	34688	115
30701	66	32494	78	33843	123	34689	115
30715	66	32495	78	33844	123	34690	115
30716	66	32496	78	33920	78	34691	115
<b>31...</b>		32497	78	33921	78	34692	115
31863	66	32686	77	33922	78	34693	115
31957	77	32687	77	33923	78	34694	115
31958	77	32688	78	33924	78	34695	115
31959	77	32689	78	33925	78	34696	115
31960	77	<b>33...</b>		33926	78	34697	115
31961	77	33259	110, 121	33927	78	34698	115
31962	77	33261	110	33928	78	34699	115
31973	78	33520	109	33929	78	34700	115
31975	79	33699	79	33930	78	34701	115
31977	79	33700	79	33931	78	34702	115
<b>32...</b>		33701	79	33932	78	34703	115
32105	77	33702	79	33961	77	34704	115
32299	78	33703	77	33962	77	34705	115
32302	78	33704	77	33963	77	34706	115
32303	78	33705	77	33964	77	34707	115
32304	78	33706	77	33965	77	34708	114
32305	78	33707	77	33966	77	34743	103

Order-No.	Page
34744	103
34745	132
<b>35...</b>	
35389	63
35390	64
35391	64
35392	64
35393	64
35394	64
35395	64
35396	64
35446	64
35456	77
35457	77
35501	64
35502	64
35503	64
35504	64
35505	64
35506	43, 58
35507	43, 58
35508	43, 58
35509	43, 58
35510	43, 58
35511	43, 58
35861	124
35862	124
35870	44
35969	121
<b>36...</b>	
36050	122
36051	121
36052	121
36053	121
36071	43, 58
36092	76
36093	76
36094	76
36114	74
36189	104
36327	78
36329	64
36330	64
36389	20
36453	94
36455	63
36487	94
36536	64
36537	64
36538	64
36539	64
36540	64
36541	64
36542	64

Order-No.	Page
36558	63
36791	34
<b>37...</b>	
37067	132
37137	18
37147	43, 58
37222	43, 58
37223	43, 58
37224	43, 58
37225	43, 58
37226	43, 58
37227	43, 58
37351	93
37402	104
37403	104
37450	108
37871	132
<b>38...</b>	
38020	21
38074	36
38191	100
38362	63
38370	78
38371	78
38372	78
38552	120
38601	80
38610	50
38798	121
38918	46
38919	46
38920	46
38921	46
38925	47
38926	47
38927	47
38928	47
38929	47
38930	47
38931	46
38932	46
38933	46
38934	46
38935	46
38936	46
<b>39...</b>	
39029	88
39037	89
39039	89
39040	88
39041	88
39045	89
39076	74
39078	88



Order-No.	Page
39124	89
39134	76
39178	79
39179	79
39180	79
39181	79
39182	79
39183	79
39184	78
39185	78
39186	78
39187	78
39188	79
39189	79
39190	79
39191	79
39192	79
39193	79
39194	79
39195	78
39196	78
39197	78
39198	78
39199	78
39200	79
39201	79
39202	79
39203	79
39204	79
39206	79
39207	79
39208	79
<b>40...</b>	
40282	22
40523	17
40674	35
40921	102
40923	110
40948	21
<b>41...</b>	
41003	62
41141	64
41142	64
41143	64
41144	64
41145	64
41146	64
41147	64
41159	43, 58
41160	43, 58
41223	22
41230	54
41231	51
41232	52

Order-No.	Page
41233	52
41234	50
41246	123
41274	102
41279	102
41286	130
41289	138
41341	40
41342	40
41343	40
41344	40
41345	40
41476	40
41477	40
41478	40
41479	40
41824	86
41825	86
41826	86
41827	87
41828	87
41829	87
41830	85
41831	85
41832	87
41833	87
41834	86
41911	30
41912	30
41913	31
41914	31
41915	31
41923	104
41979	92
<b>42...</b>	
42062	122
42068	132
42069	15
42071	138
42074	133
42086	39, 131
42098	84
42099	84
42114	84
42115	84
42116	84
42117	84
42118	84
42135	84
42136	85
42137	85
42138	85
42139	85
42162	122



Order-No.	Page	Order-No.	Page	Order-No.	Page
42374	68	43078	45, 70	43151	43, 58
42375	68	43079	45, 70	43152	42,57
42376	68	43080	45, 70	43153	42,57
42377	68	43081	45, 70	43154	42,57
42378	68	43082	45, 70	43155	42,57
42379	68	43083	45, 70	43156	42,57
42380	68	43084	45, 70	43157	42,57
42471	68	43085	45, 70	43158	42,57
42989	68	43086	45, 70	43159	42,57
<b>43...</b>		43087	45, 70	43160	42,57
43022	24	43088	45, 71	43161	41, 56
43023	23	43089	45, 71	43162	41, 56
43024	23	43090	45, 71	43167	55
43026	70	43091	45, 71	43177	46
43027	70	43092	45, 71	43292	59
43028	70	43093	45, 71	43326	102
43029	70	43094	45, 71	43335	102
43030	70	43095	45, 71	43340	102
43031	70	43096	45, 71	43449	54
43032	70	43097	45, 71	43465	19
43033	70	43098	45, 71	43466	36
43034	70	43099	45, 71	43467	53
43035	70	43100	72		
43036	70	43101	72		
43037	70	43102	72		
43038	70	43103	72		
43039	70	43104	72		
43040	70	43105	72		
43041	70	43106	72		
43042	70	43107	72		
43043	70	43108	72		
43044	70	43109	72		
43052	73	43110	72		
43053	73	43111	72		
43055	73	43112	72		
43056	73	43113	72		
43057	73	43114	43, 58		
43058	73	43115	43, 58		
43061	70	43116	43, 58		
43062	73	43117	43, 58		
43063	73	43125	104		
43065	71	43128	44		
43066	71	43139	59		
43067	71	43140	43, 58		
43068	71	43141	43, 58		
43069	71	43142	43, 58		
43070	71	43143	43, 58		
43071	71	43144	43, 58		
43072	71	43145	43, 58		
43073	71	43146	43, 58		
43074	71	43147	43, 58		
43075	71	43148	43, 58		
43076	71	43149	43, 58		
43077	45, 70	43150	43, 58		

# Overview of torque tools

Tools	Precision	Setting	Special feature	Nm range	Torque range				
					0,1 Nm	1 Nm	10 Nm	20 Nm	< 50 Nm
<b>easyTorque adapter</b> 	± 10%	fixed	VDE certification, Permanently preset in factory	5 Versions 0,8 – 4,0					
<b>TorqueVario®-S VDE</b> 	± 6%	variable	VDE certification, numeric scale	0,5 – 2,0					
				0,8 – 5,0					
<b>Torque screwdriver with T-handle TorqueVario®-S T electric</b> 	± 6%	variable	VDE certification, numeric scale	5 – 14					

# The cutting capacities for our pliers.

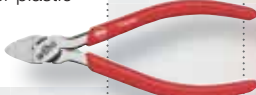
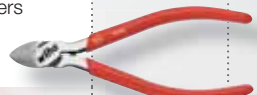
Soft wire Plastic/ copper/ aluminium electrical cable/electrical cable/ silver wire					Medium-hard wire Iron nails, brass screws, wire-mesh fencing				
1	2	3	4	5	6	7	8	9	10
Diagonal cutters for plastic 					Precision mechanic's diagonal cutters 				

Interchangeable blades

slimBits  
Series 2831

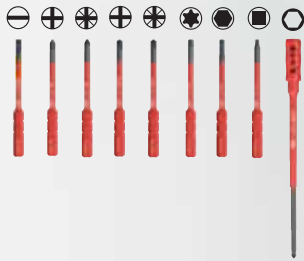

Series 2831



Hard wire

Screws, wire rope, wire basket, electric rail

Hardened spring steel

Springs, hardened pins, chains

11

12

13

14

15

16

17

18

19

20

21

TriCut installation pliers

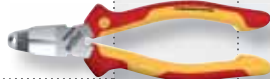

Electrician's diagonal cutters

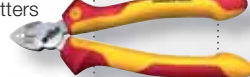

Inomic® combination pliers

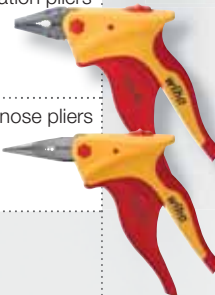

Inomic® needle nose pliers

Combination pliers



Diagonal cutters

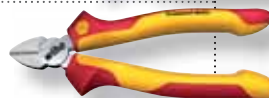

Heavy-duty diagonal cutters

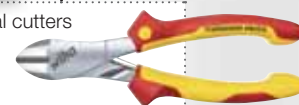

Needle nose pliers



Bent needle nose pliers

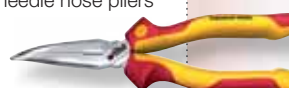

BiCut® Diagonal cutters  
100 % /



High-leverage  
combination pliers

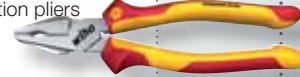

200 %

Range of Applications

Fastening/ jamming

Trimming/ cutting

Supplying/ holding

Stripping/ insulating/  
crimping

Surveying/ marking/  
measuring/ checking

Striking/ chiselling

# Legend

## Drives

	Triangular nut
	Hex
	Square nut
	Hexagon socket
	Internal hexagon with drill hole (tamper-resistant)
	Tamper Resistant hex
	Countersink
	Combination drill bit
	Pentalobe PL
	Y-Type
	Phillips PH (cross-recessed)
	Pozidriv PZ (Phillips)
	Robertson
	Round tip
	Slotted
	Slotted nut
	SIT
	Spanner
	Twist drill
	Sliding sleeve
	Torq-Set®
	TORX®
	TORX® with drill hole (tamper-resistant)
	TORX PLUS®
	Tri-Wing®
	Multitooth
	Square reaming blade
	Xeno SL/PZ

## Drives

	Square nut
	Square
	G7 drive system
	Threaded connector
	SDS-Plus®
	Hex

## Screwdrivers [mm]

	Cut width
	Tip width
	Round blade dimension
	Hex blade
	Hex bolster
	Scraper width
	Clip opening
	Tip width
	Head width, nut driver
	Blade length
	Shaft lengths
	Handle length
	Handle diameter
	Torque T-handle length
	Torque T-handle width
	Max. torque value [Nm]
	Max. torque value [in.lbs]
	Accuracy [%]
	Cable key depth

## L-keys [mm]

	Round blade dimension
	Hex blade
	Hex bolster
	Shaft lengths
	Blade length
	Side driver length T-handle
	Handle width
	Diameter

## Bits [mm]

	Threaded connector
	Drill working length
	Screw size

## Pliers [mm]

	Flat jaws
	Half round jaws
	Round jaws
	Cutter without bevel
	Cutter with small bevel
	Cutter with bevel
	Anvil cutter
	Center cutter
	Scissors cutter
	Front cutting edge in stripping pliers
	Max. diameter
	Max. cross-section
	Max. gripper pipe diameter
	Max. gripper width across flats
	External retaining ring
	Internal retaining ring
	Clamping range
	Opening width flat
	Cutting force
	with opening spring
	American Wire Gauge
	Saw blade length

## Measurement tools [mm]

	Width of segments
	Colour
	Measurement capacity [mm]
	Measurement capacity in Inch
	Battery
	LED lumens
	Laser light

## Soft faced hammer [mm]

	Face diameter
	Hammer face width
	Hammer head width

## General symbols

	Weight, g
	Diameter
	Blister packed
	Total length
	Gesamtlänge Inch
	Packaging unit



# Legend

## Ranges

-  Case strength
-  Wheel-along case
-  Case shape
-  Case suitable for transport by air



## Torque



-  Precision: ±6%
-  Accuracy ±10%
-  slimTECHNOLOGY

## L-keys

-  MagicRing®
-  MagicSpring®

## Elektro

-  Torque safety check
-  Saves time



-  Ball end can swivel up to 25°
-  TORX® ball end; can swivel up to 25°

-  Visible in UV light





## Screwdrivers



-  MagicRing®
-  MagicSpring®
-  Ball end can swivel up to 25°
-  slimTECHNOLOGY

## Bits

-  Suitable for impact screwdrivers
-  Lifespan 120 times longer
-  Visible in UV light

## Pliers

-  Cutting-to-length diameter
-  Skinning diameter length
-  Automatic skinning
-  DynamicJoint®



-  Heavy-duty diagonal cutters
-  OptiGrip

-  MagicTips®
-  BiCut® Power



-  TriCut®

-  Inomic®

## Impact tools

-  Optimum weight distribution
-  Soft hammer end
-  Levers out nail clamp

## Measurement tool

-  Fully encased
-  Visible from just 10°
-  Visible in UV light

## General information

-  Recommended for electricians – non-insulated
-  VDE-tested and certified
-  CE marking
-  ESD electronics mark









## X-ON Electronics

Largest Supplier of Electrical and Electronic Components

*Click to view similar products for [Screwdrivers, Nut Drivers & Socket Drivers](#) category:*

*Click to view products by [Wiha International](#) manufacturer:*

Other Similar products are found below :

[1406504-2](#) [272012M](#) [271001M](#) [HMM-HH](#) [00-8987-YWPP](#) [9918560000](#) [32024](#) [92270](#) [72820](#) [72905](#) [72741](#) [32061](#) [30751](#) [KLEIN TOOLS](#)  
[SCREWDRIVER 4-IN-1](#) [612020B](#) [35-045](#) [6951](#) [83](#) [9977](#) [EMF](#) [99833](#) [S3166V](#) [X103V](#) [XTD10TP](#) [HS7N](#) [HS618N](#) [LN25MMN](#)  
[XST1010N](#) [P4N](#) [P12SN](#) [R5324N](#) [99764N](#) [P8N](#) [99312N](#) [R3163N](#) [SX101N](#) [LN22N](#) [XTD10N](#) [9955MMN](#) [995MMN](#) [996MMN](#) [LN25N](#)  
[THS9N](#) [R3166N](#) [R144N](#) [RB2N](#) [HS10N](#) [99964BPN](#) [HS11N](#) [HS12N](#)