

Threaded protection tube

Design per DIN 43772 form 5, 8

Model TW45

WIKA data sheet TW 95.45

Applications

- Chemical industry, process technology, equipment manufacturing
- For low and medium process loads

Special features

- Designs per DIN 43772
- Design TW45-F: Form 5
- Design TW45-G: Form 8

Description

Each thermowell/protection tube is an important component of any temperature measuring location. It is used to separate the process from the surrounding area, thus protecting the environment and operating personnel and keeps aggressive media, high pressures and flow rates from the temperature probe itself and thereby enables the thermometer to be exchanged during operation.

Based on the almost limitless application possibilities, there are a large number of variants, such as thermowell designs or materials. The type of process connection and the basic method of manufacture are important design differentiation criteria. A basic differentiation can be made between threaded and weld-in thermowells/protection tubes, and those with flange connections.

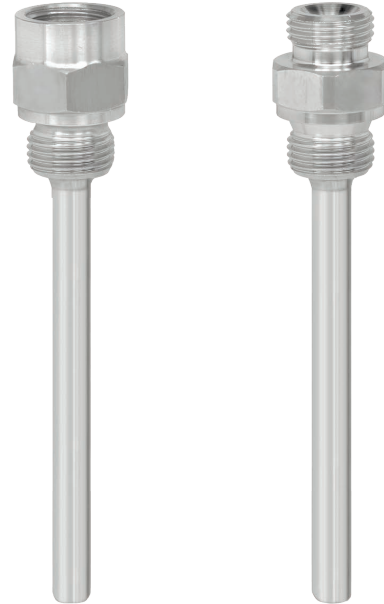

Fig. left: Design TW45-F
Fig. right: Design TW45-G

Furthermore, one can differentiate between protection tubes and thermowells. Protection tubes are constructed from a tube, that is closed at the tip by a welded solid tip. Thermowells are manufactured from solid bar stock.

The TW45 series of threaded protection tubes ¹⁾ are suitable for use with numerous electrical and mechanical thermometers from WIKA.

Due to their design to DIN 43772, these protection tubes for low and medium process loads are suitable for use in the chemical industry, process technology and equipment manufacturing.

¹⁾ With short insertion lengths (copper alloy), solid-machined version available as an option

Specifications

Basic information	
Protection tube form	
Design TW45-F	Form 5
Design TW45-G	Form 8
Version	<ul style="list-style-type: none"> ■ Version per DIN 43772 ■ Design similar to DIN 43772 (fast response)
Material (wetted)	<ul style="list-style-type: none"> ■ Stainless steel 1.4571 ■ Copper alloy

Process connection			
Type of process connection	<ul style="list-style-type: none"> ■ G ½ B male thread ■ G ¾ B male thread 		
Connection to thermometer			
Design TW45-F	<ul style="list-style-type: none"> ■ G ½ female thread ■ G ¾ female thread 		
Design TW45-G	<ul style="list-style-type: none"> ■ G ½ B male thread ■ G ¾ B male thread 		
Bore size			
Designs per DIN 43772	<ul style="list-style-type: none"> ■ Ø 7 mm [0.28 in] ■ Ø 9 mm [0.35 in] ■ Ø 11 mm [0.43 in] 		
Designs similar to DIN 43772, fast response	<ul style="list-style-type: none"> ■ Ø 6.2 mm [0.24 in] ■ Ø 8.2 mm [0.32 in] ■ Ø 8.5 mm [0.34 in] ■ Ø 10.2 mm [0.4 in] 		
Insertion length U			
Design TW45-F	<ul style="list-style-type: none"> ■ 82 mm [3.23 in] ■ 142 mm [5.59 in] ■ 182 mm [7.17 in] ■ 232 mm [9.13 in] ■ 382 mm [15.04 in] 		
Design TW45-G	<ul style="list-style-type: none"> ■ 73 mm [2.87 in] ■ 110 mm [4.33 in] ■ 170 mm [6.69 in] ■ 260 mm [10.24 in] ■ 410 mm [16.14 in] 		
Overall length L	Insertion length U ₁ + 28 mm [1.1 in]		
Suitable stem length I₁ (dial thermometer)			
Design TW45-F	Connection design S ¹⁾ , 4 or 5	I ₁ = L - 10 mm [0.4 in] or I ₁ = U ₁ + 18 mm [0.7 in]	
	Connection design 2	I ₁ = L - 30 mm [1.2 in] or I ₁ = U ₁ - 2 mm [0.1 in]	
Design TW45-G	Connection design 3	I ₁ = L - 12 mm [0.5 in] or I ₁ = U ₁ + 16 mm [0.6 in]	
Suitable insertion length I₁ (machine glass thermometer)			
Design TW45-F	Connection design E	I ₁ = L - 10 mm [0.4 in] or I ₁ = U ₁ + 18 mm [0.7 in]	
Design TW45-G	Connection design 3	Process connection (thermometer): G ½	I ₁ = L - 12 mm [0.5 in] or I ₁ = U ₁ + 16 mm [0.6 in]
		Process connection (thermometer): G ¾	I ₁ = L - 8 mm [0.3 in] or I ₁ = U ₁ + 20 mm [0.8 in]

1) Not suitable for use with protection tube inner diameter 6.2 mm (tube 8 x 0.9 mm), Ø 8.2 mm (tube 10 x 0.9 mm) and 10.2 mm (tube 12 x 0.9 mm).

Operating conditions	
Max. process temperature, process pressure	160 °C [320 °F] with copper alloy as protection tube material (6 bar [87 psi] stat.) Depending on: <ul style="list-style-type: none"> ■ Load diagram DIN 43772 ■ Protection tube design <ul style="list-style-type: none"> - Dimensions - Material ■ Process conditions <ul style="list-style-type: none"> - Flow rate - Medium density
Wake frequency calculation (option)	For critical applications, is recommended in accordance with Ditttrich/Klotter as a WIKA engineering service → For further information, see Technical information IN 00.15 "Wake frequency calculation".

Certificates (option)

Certificates	
Certificates	<ul style="list-style-type: none"> ■ 2.2 test report ■ 3.1 inspection certificate

Approvals and certificates, see website

Dimensions in mm [in]

Design TW45-F

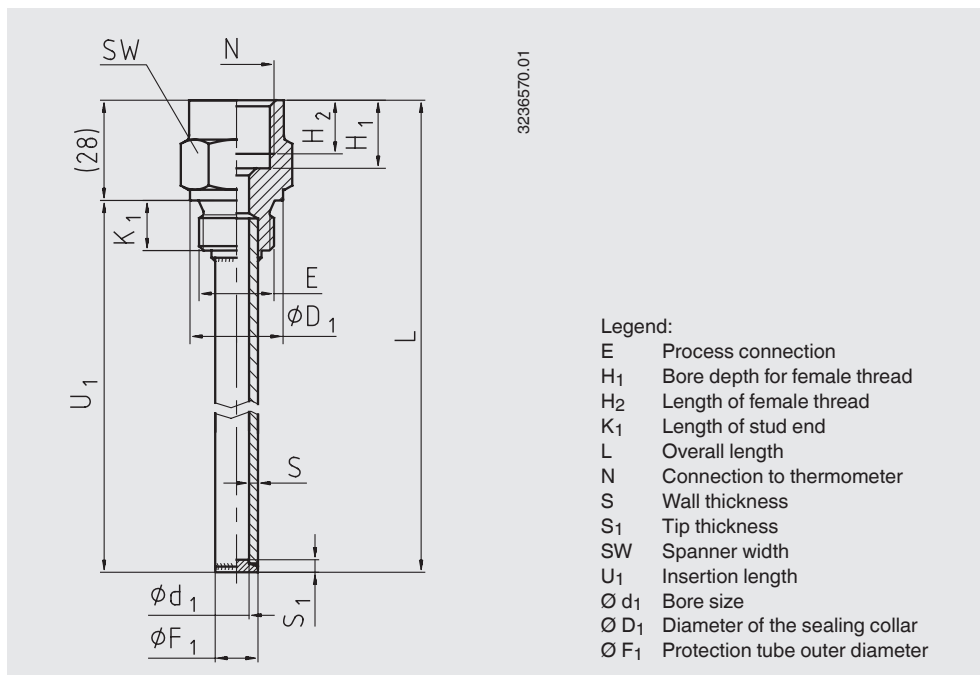

Material	Dimensions in mm [in]											Weight in kg [lbs]	
	E	N	Ø d ₁	Ø D ₁	Ø F ₁	H ₁	H ₂	K ₁	S	S ₁	SW	U ₁ = 82 mm [3.22 in]	U ₁ = 382 mm [15.04 in]
Stainless steel 1.4571	G ½ B	G ½	7 [0.28]	26 [1.02]	12 [0.47]	19 [0.75]	15 [0.59]	14 [0.55]	2.5 [0.1]	3.5 [0.15]	27 [1.06]	0.15 [0.33]	0.33 [0.73]
	G ½ B	G ½	9 [0.35]	26 [1.02]	14 [0.55]	19 [0.75]	15 [0.59]	14 [0.55]	2.5 [0.1]	3.5 [0.14]	27 [1.06]	0.15 [0.33]	0.36 [0.79]
	G ½ B	G ½	11 [0.43]	26 [1.02]	14 [0.55]	19 [0.75]	15 [0.59]	14 [0.55]	1.5 [0.06]	2.5 [0.1]	27 [1.06]	0.12 [0.26]	0.28 [0.62]
	G ½ B	G ½	6.2 [0.24]	26 [1.02]	8 [0.32]	19 [0.75]	15 [0.59]	14 [0.55]	0.9 [0.04]	1 [0.04]	27 [1.06]	0.12 [0.26]	0.18 [0.4]
	G ½ B	G ½	8.2 [0.32]	26 [1.02]	10 [0.39]	19 [0.75]	15 [0.59]	14 [0.55]	0.9 [0.04]	1 [0.04]	27 [1.06]	0.12 [0.26]	0.18 [0.4]
	G ½ B	G ½	10.2 [0.40]	26 [1.02]	12 [0.47]	19 [0.75]	15 [0.59]	14 [0.55]	0.9 [0.04]	1 [0.04]	27 [1.06]	0.12 [0.26]	0.19 [0.42]
	G ¾ B	G ½	7 [0.28]	32 [1.26]	12 [0.47]	19 [0.75]	15 [0.59]	16 [0.63]	2.5 [0.1]	3.5 [0.14]	32 [1.26]	0.24 [0.53]	0.42 [0.93]
	G ¾ B	G ½	9 [0.35]	32 [1.26]	14 [0.55]	19 [0.75]	15 [0.59]	16 [0.63]	2.5 [0.1]	3.5 [0.14]	32 [1.26]	0.24 [0.53]	0.45 [0.99]
	G ¾ B	G ½	11 [0.43]	32 [1.26]	14 [0.55]	19 [0.75]	15 [0.59]	16 [0.63]	1.5 [0.06]	2.5 [0.1]	32 [1.26]	0.22 [0.49]	0.37 [0.82]
	G ¾ B	G ½	6.2 [0.24]	32 [1.26]	8 [0.32]	19 [0.75]	15 [0.59]	16 [0.63]	0.9 [0.04]	1 [0.04]	32 [1.26]	0.21 [0.46]	0.27 [0.6]
	G ¾ B	G ½	8.2 [0.32]	32 [1.26]	10 [0.39]	19 [0.75]	15 [0.59]	16 [0.63]	0.9 [0.04]	1 [0.04]	32 [1.26]	0.21 [0.46]	0.27 [0.6]
	G ¾ B	G ½	10.2 [0.40]	32 [1.26]	12 [0.47]	19 [0.75]	15 [0.59]	16 [0.63]	0.9 [0.04]	1 [0.04]	32 [1.26]	0.21 [0.46]	0.28 [0.62]
	G ¾ B	G ¾	7 [0.28]	32 [1.26]	12 [0.47]	22 [0.87]	17 [0.67]	16 [0.63]	2.5 [0.1]	3.5 [0.14]	32 [1.26]	0.20 [0.44]	0.38 [0.84]
	G ¾ B	G ¾	9 [0.35]	32 [1.26]	14 [0.55]	22 [0.87]	17 [0.67]	16 [0.63]	2.5 [0.1]	3.5 [0.14]	32 [1.26]	0.20 [0.44]	0.41 [0.9]

Material	Dimensions in mm [in]											Weight in kg [lbs]	
	E	N	Ø d ₁	Ø D ₁	Ø F ₁	H ₁	H ₂	K ₁	S	S ₁	SW	U ₁ = 82 mm [3.22 in]	U ₁ = 382 mm [15.04 in]
Stainless steel 1.4571	G ¾ B	G ¾	11 [0.43]	32 [1.26]	14 [0.55]	22 [0.87]	17 [0.67]	16 [0.63]	1.5 [0.06]	2.5 [0.1]	32 [1.26]	0.18 [0.4]	0.33 [0.73]
	G ¾ B	G ¾	6.2 [0.24]	32 [1.26]	8 [0.32]	22 [0.87]	17 [0.67]	16 [0.63]	0.9 [0.035]	1 [0.04]	32 [1.26]	0.17 [0.37]	0.23 [0.51]
	G ¾ B	G ¾	8.2 [0.32]	32 [1.26]	10 [0.39]	22 [0.87]	17 [0.67]	16 [0.63]	0.9 [0.04]	1 [0.04]	32 [1.26]	0.17 [0.37]	0.23 [0.51]
	G ¾ B	G ¾	10.2 [0.40]	32 [1.26]	12 [0.47]	22 [0.87]	17 [0.67]	16 [0.63]	0.9 [0.04]	1 [0.04]	32 [1.26]	0.17 [0.37]	0.24 [0.53]
Copper alloy	G ½ B	G ½	8.5 [0.34]	26 [1.02]	10 [0.39]	19 [0.75]	15 [0.59]	14 [0.55]	0.75 [0.03]	0.75 [0.03]	27 [1.06]	0.11 [0.24]	0.18 [0.4]
	G ¾ B	G ½	8.5 [0.34]	32 [1.26]	10 [0.39]	19 [0.75]	15 [0.59]	16 [0.63]	0.75 [0.03]	0.75 [0.03]	32 [1.26]	0.23 [0.51]	0.29 [0.64]

Design TW45-G

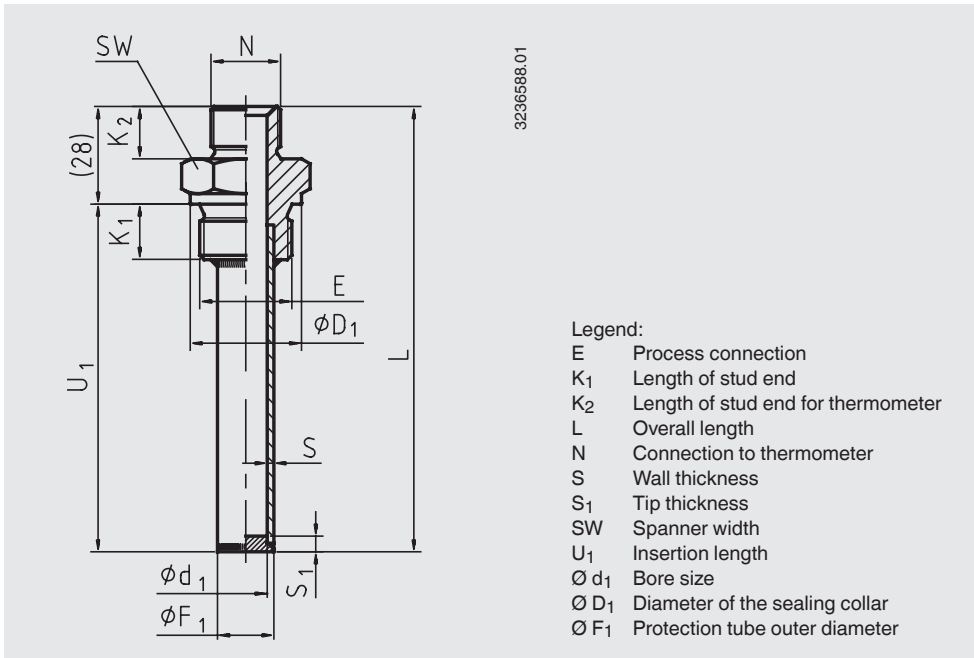

Material	Dimensions in mm [in]											Weight in kg [lbs]	
	E	N	Ø d ₁	Ø D ₁	Ø F ₁	H ₁	H ₂	K ₁	S	S ₁	SW	U ₁ = 73 mm [2.87 in]	U ₁ = 410 mm [16.14 in]
Stainless steel 1.4571	G ½ B	G ½	7 [0.28]	26 [1.02]	12 [0.47]	19 [0.75]	15 [0.59]	14 [0.55]	2.5 [0.1]	3.5 [0.15]	27 [1.06]	0.14 [0.31]	0.34 [0.75]
	G ½ B	G ½	9 [0.35]	26 [1.02]	14 [0.55]	19 [0.75]	15 [0.59]	14 [0.55]	2.5 [0.1]	3.5 [0.14]	27 [1.06]	0.14 [0.31]	0.37 [0.82]
	G ½ B	G ½	11 [0.43]	26 [1.02]	14 [0.55]	19 [0.75]	15 [0.59]	14 [0.55]	1.5 [0.06]	2.5 [0.1]	27 [1.06]	0.12 [0.26]	0.30 [0.66]
	G ½ B	G ½	6.2 [0.24]	26 [1.02]	8 [0.32]	19 [0.75]	15 [0.59]	14 [0.55]	0.9 [0.04]	1 [0.04]	27 [1.06]	0.13 [0.27]	0.20 [0.44]
	G ½ B	G ½	8.2 [0.32]	26 [1.02]	10 [0.39]	19 [0.75]	15 [0.59]	14 [0.55]	0.9 [0.04]	1 [0.04]	27 [1.06]	0.13 [0.27]	0.20 [0.44]
	G ½ B	G ½	10.2 [0.40]	26 [1.02]	12 [0.47]	19 [0.75]	15 [0.59]	14 [0.55]	0.9 [0.04]	1 [0.04]	27 [1.06]	0.11 [0.24]	0.18 [0.4]
	G ¾ B	G ½	7 [0.28]	32 [1.26]	12 [0.47]	19 [0.75]	15 [0.59]	16 [0.63]	2.5 [0.1]	3.5 [0.14]	32 [1.26]	0.22 [0.49]	0.43 [0.95]
	G ¾ B	G ½	9 [0.35]	32 [1.26]	14 [0.55]	19 [0.75]	15 [0.59]	16 [0.63]	2.5 [0.1]	3.5 [0.14]	32 [1.26]	0.22 [0.49]	0.46 [1.01]
	G ¾ B	G ½	11 [0.43]	32 [1.26]	14 [0.55]	19 [0.75]	15 [0.59]	16 [0.63]	1.5 [0.06]	2.5 [0.1]	32 [1.26]	0.20 [0.44]	0.39 [0.86]
	G ¾ B	G ½	6.2 [0.24]	32 [1.26]	8 [0.32]	19 [0.75]	15 [0.59]	16 [0.63]	0.9 [0.04]	1 [0.04]	32 [1.26]	0.21 [0.46]	0.28 [0.62]
	G ¾ B	G ½	8.2 [0.32]	32 [1.26]	10 [0.39]	19 [0.75]	15 [0.59]	16 [0.63]	0.9 [0.04]	1 [0.04]	32 [1.26]	0.21 [0.46]	0.28 [0.62]
	G ¾ B	G ½	10.2 [0.40]	32 [1.26]	12 [0.47]	19 [0.75]	15 [0.59]	16 [0.63]	0.9 [0.04]	1 [0.04]	32 [1.26]	0.20 [0.44]	0.27 [0.6]

Ordering information

Model / Protection tube form / Protection tube material / Process connection / Connection to thermometer / Insertion length U₁ / Dimension of pipe / Assembly with thermometer / Certificates / Options

© 12/2007 WIKA Alexander Wiegand SE & Co. KG, all rights reserved.
The specifications given in this document represent the state of engineering at the time of publishing.
We reserve the right to make modifications to the specifications and materials.



WIKAL Alexander Wiegand SE & Co. KG
Alexander-Wiegand-Straße 30
63911 Klingenberg/Germany
Tel. +49 9372 132-0
Fax +49 9372 132-406
info@wika.de
www.wika.de

X-ON Electronics

Largest Supplier of Electrical and Electronic Components

Click to view similar products for [Environmental Test Equipment](#) category:

Click to view products by [Wika](#) manufacturer:

Other Similar products are found below :

[CW40](#) [F150C10E3DRT](#) [F150LTC20](#) [F150CD10E2](#) [F150L75](#) [F150LRS](#) [2837806](#) [4328074](#) [4366444](#) [S-11](#) [382153](#) [700PTP-1](#) [GEO-](#)
[CABLE-REEL-50M](#) [H115](#) [H300](#) [F150-SLC50](#) [TM-192](#) [TM-192D](#) [TM-414](#) [HS115](#) [SHG-02](#) [SHS-05](#) [SHG-01](#) [RH520-220](#) [TESTO 175-H1](#)
[0572 1754](#) [TESTO 830-T1](#) [0560 8311](#) [AX-5002](#) [AX-5003](#) [AX-B150](#) [AX-B180](#) [AX-B350](#) [AX-L230](#) [AX-PH02](#) [12227021](#) [12228657](#)
[12229067](#) [12230090](#) [7358958](#) [12230111](#) [12230146](#) [12230171](#) [12229190](#) [12228801](#) [12228665](#) [12228819](#) [12229360](#) [12230502](#) [12229378](#)
[12229394](#) [12229415](#)