

Bimetal thermometer

For air-conditioning and refrigeration systems

Model A48

WIKA data sheet TM 48.01



for further approvals
see page 4

Applications

- Air-conditioning and refrigeration systems
- Ventilation systems

Special features

- Accuracy class 2
- Nominal size 63, 80, 100 and 160
- Scale ranges from -30 ... +50 °C to 0 ... 120 °C



Bimetal thermometer, model A48.10.080

Description

The model A48 bimetal thermometer has been specifically developed for use in air-conditioning and refrigeration technology for measuring the temperature in air ducts.

Due to the flexibly adjustable flange, the thermometer can be adapted to all standard wall thicknesses of pipe insulations.

Specifications

Measuring element

Bimetal coil

Nominal size in mm

63, 80, 100 and 160

Models

Model	NS	Connection location
A48.10.063	63	Back mount (BM), centre
A48.10.080	80	
A48.10.100	100	
A48.10.160	160	

Scale ranges

Scale range in °C	Scale spacing in °C
-30 ... +50	1
-20 ... +60	1
-10 ... +50	1
0 ... 60	1
0 ... 80	1
0 ... 120	2

other scale ranges on request

Connection

Flange, steel zinc plated, adjustable on stem

- Standard: flange diameter $d_2 = 61$ mm
- Option: flange diameter $d_2 = 50$ mm

Stem

Insertion length $l = 160, 200$ and 300 mm

Ø 9 mm copper alloy

Minimum immersion depth $l_{\min} = \text{approx. } 60$ mm

other insertion lengths on request

Accuracy class

Class 2 per EN 13190

Case

Aluminium

Dial

Aluminium, white, black lettering

Pointer

Aluminium, black

Window

Acrylic plastic

Zero adjustment

At bottom of stem

Dimensions in mm

Back mount (BM)

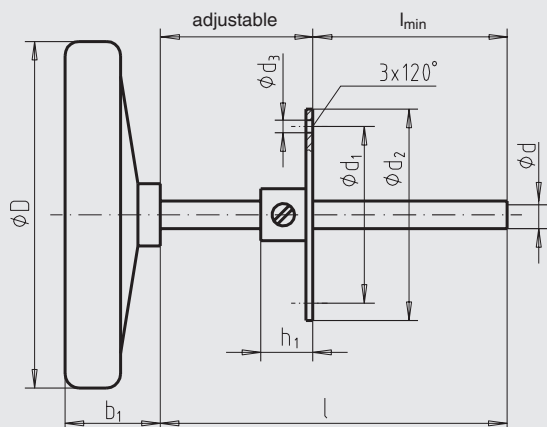





3072959.01

Legend:

Minimum immersion depth $l_{min} = 60$ mm

NS	Dimensions in mm								Weight in kg
	ϕD	b_1	ϕd	ϕd_1	ϕd_2	ϕd_3	h_1	l	
63	63	20	9	51	61	3.6	13	160, 200, 300	0.16
80	80	22	9	51	61	3.6	13	160, 200, 300	0.18
100	100	27	9	51	61	3.6	13	160, 200, 300	0.21
160	160	29	9	51	61	3.6	13	160, 200, 300	0.36

Approvals

Logo	Description	Country
	GOST (option) Metrology/measurement technology	Russia
	KazInMetr (option) Metrology/measurement technology	Kazakhstan
-	MTSCHS (option) Permission for commissioning	Kazakhstan
	UkrSEPRO (option) Metrology/measurement technology	Ukraine
	Uzstandard (option) Metrology/measurement technology	Uzbekistan
-	CRN (option) Safety (e.g. electr. safety, overpressure, ...)	Canada

Certificates (option)

- 2.2 test report

Approvals and certificates, see website

Ordering information

Model / Nominal size / Scale range / Connection / Insertion length l / Options

© 07/2008 WIKA Alexander Wiegand SE & Co. KG, all rights reserved.
The specifications given in this document represent the state of engineering at the time of publishing.
We reserve the right to make modifications to the specifications and materials.



X-ON Electronics

Largest Supplier of Electrical and Electronic Components

Click to view similar products for [Environmental Test Equipment](#) category:

Click to view products by [Wika](#) manufacturer:

Other Similar products are found below :

[CW40](#) [F150C10E3DRT](#) [F150LTC20](#) [F150CD10E2](#) [F150L75](#) [F150LRS](#) [2837806](#) [4328074](#) [4366444](#) [S-11](#) [382153](#) [700PTP-1](#) [GEO-](#)
[CABLE-REEL-50M](#) [H115](#) [H300](#) [F150-SLC50](#) [TM-192](#) [TM-192D](#) [TM-414](#) [HS115](#) [SHG-02](#) [SHS-05](#) [SHG-01](#) [RH520-220](#) [TESTO 175-H1](#)
[0572 1754](#) [TESTO 830-T1](#) [0560 8311](#) [AX-5002](#) [AX-5003](#) [AX-B150](#) [AX-B180](#) [AX-B350](#) [AX-L230](#) [AX-PH02](#) [12227021](#) [12228657](#)
[12229067](#) [12230090](#) [7358958](#) [12230146](#) [12230171](#) [12229190](#) [12228801](#) [12228665](#) [12228819](#) [12229360](#) [12230502](#) [12229378](#) [12229394](#)
[12229415](#) [12228835](#)