



1-LineLow Capacitance Bi-directional TVS Diode

General description

GBLC05C a 5.0V bi-directional TVS diode, utilizing leading monolithic silicon technology to provide fast response time and low ESD clamping voltage, making his device an ideal solution for protecting voltage sensitive high-speed data lines. The GBLC05C has a low capacitance with a typical value at 0.6pF,and complies with the IEC61000-4-2(ESD) standard with $\pm 30\text{KV}$ air and $\pm 30\text{KV}$ contact discharge. It is assembled into a leadfree SOD-323 package. The small size, low capacitance and high ESD surge protection make GBLC05C an idea choice to protect cell phone, wireless systems, and communication equipment.

Features and benefits

- . Ultra Low Capacitance 0.6 pF(Typ)
- . 350W peak pulse power (8/20 μS)
- . Working Voltage 5.0V
- . Low leakage current: nA Level
- . Complies with following standards:
 - IEC 61000-4-2 (ESD) immunity test
Air discharge: $\pm 30\text{kV}$ / Contact discharge: $\pm 30\text{kV}$
 - IEC61000-4-5 (Lightning) 18A (8/20 μS)
 - IEC61000-4-4 (EFT) 80A (5/50nS)
- . RoHS compliant

Application information

- . High- speed data lines
- . Smart phones
- . USB Ports
- . Wireless Systems
- . Ethernet 10/100/1000 Base T

Ordering information

Device	Marking	Packaging	Reel Size
GBLC05C	AC	3000/Tape & Reel	7 inch

Schematic & Pin configuration

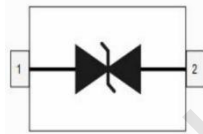
Simplified outline	Graphic symbol
	

Maximum Ratings (T_A = 25 °C, unless otherwise specified)

Parameter	Symbol	Value	Unit
Peak Pulse Power (tp = 8/20μs)	P _{Pk}	350	W
Peak Pulse Current(tp = 8/20μs)	I _{PP}	18	A
ESD voltage IEC 61000-4-2 (air discharge)	V _{ESD}	30	KV
ESD voltage IEC 61000-4-2 (contact discharge)	V _{ESD}	30	KV
Storage Temperature Range	T _{stg}	-55 to +150	°C
Operating Temperature Range	T _{OP}	-40 to +125	°C

Electrical Characteristics (T_A = 25 °C, unless otherwise specified)

Parameter	Symbol	Min	Typ	Max	Unit	Condition
Reverse Working Voltage	V _{RWM}	--	--	5.0	V	
Breakdown Voltage	V _{BR}	6.1	6.8	8.0	V	I _T =1mA
Leakage Current I _{Leak}	I _R	--	--	200	nA	V _{RWM} =5.0V
Clamping Voltage	V _C	--	8.0	10.0	V	I _{PP} =1A, T _p =8/20μs
Clamping Voltage	V _C	--	16.0	20.0	V	I _{PP} =18A, T _p =8/20μs
Junction Capacitance	C _J	--	0.6	0.9	pF	V _R =0V, f=1MHz

Typical Performance Characteristics ($T_A=25^\circ\text{C}$ unless otherwise Specified)

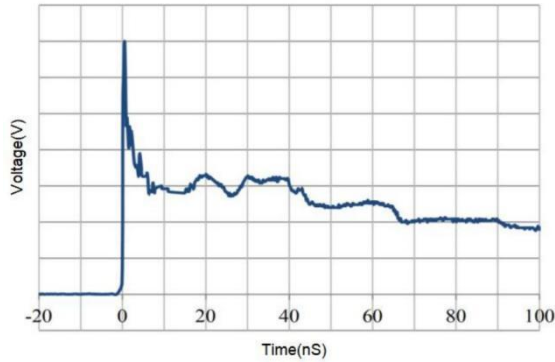

IEC61000-4-2 Pulse Waveform

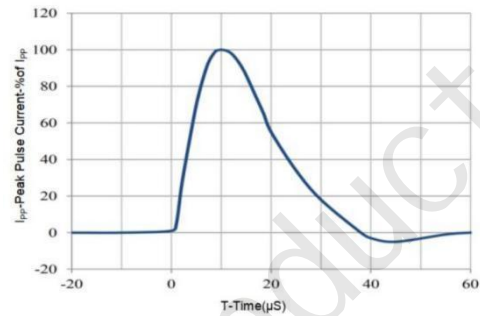

IEC61000-4-5 8X20µs Pulse Waveform

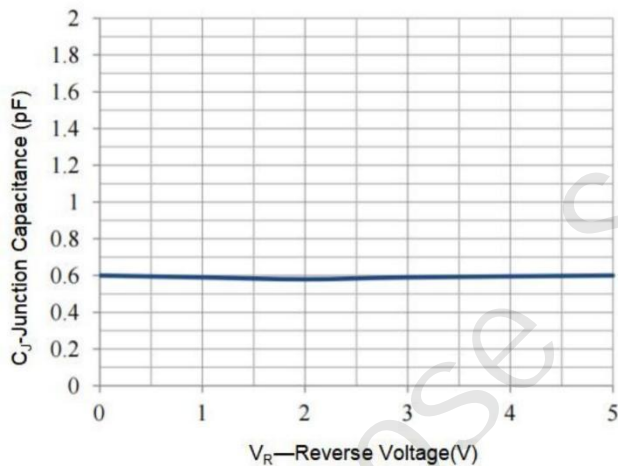

Junction Capacitance vs. Reverse Voltage

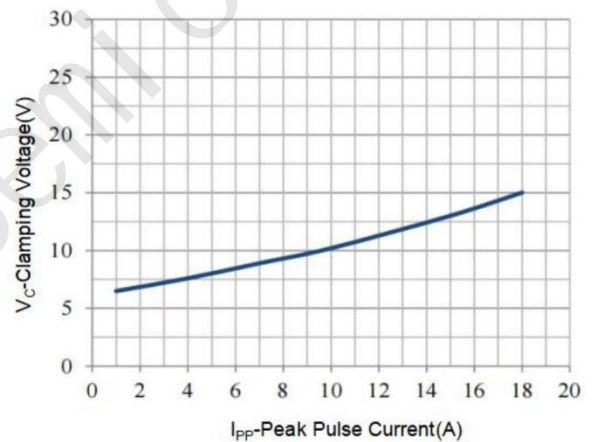

Clamping Voltage vs. Peak Pulse Current

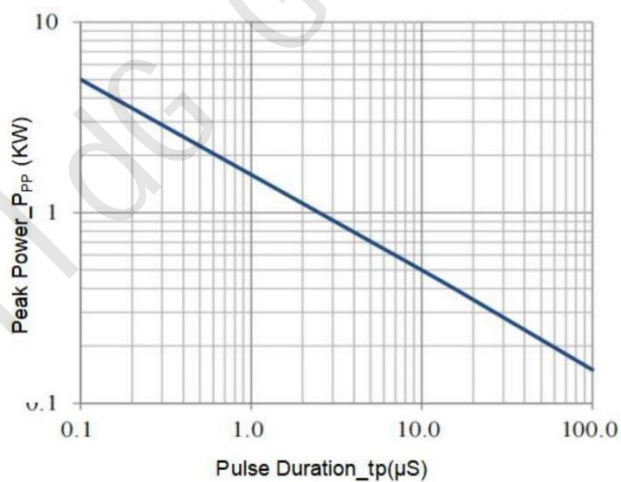

Peak Pulse Power vs. Pulse Time

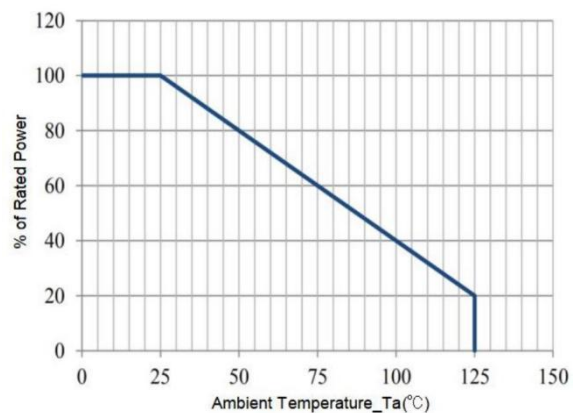

Power Derating Curve

Package Outline Dimensions (mm)

SOD323

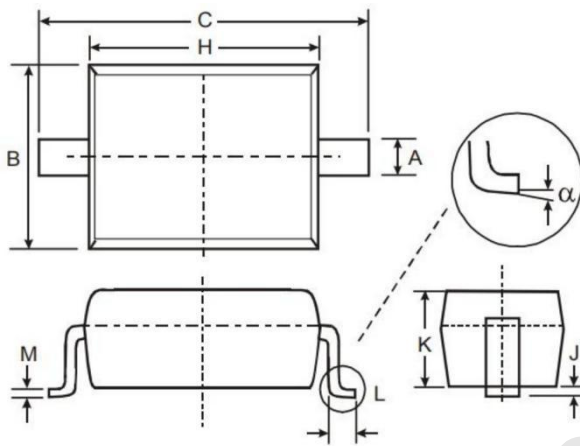

SYMBOL	DIMENSIONS	
	MIN	MAX
A	0.25	0.40
B	1.20	1.40
C	2.30	2.70
H	1.50	1.80
J	0.01	0.15
K	0.80	1.10
L	0.20	0.40
M	0.08	0.25
“	0°	8°

Soldering Footprint (mm)

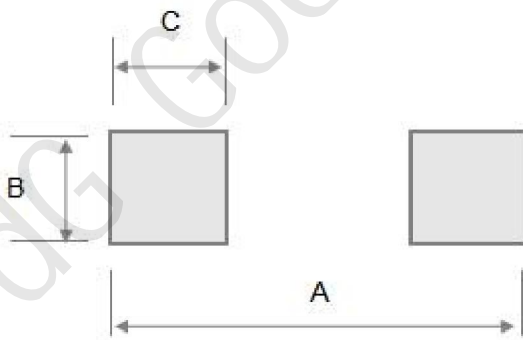

SYMBOL	DIMENSIONS
A	0.32
B	0.80
C	0.80

X-ON Electronics

Largest Supplier of Electrical and Electronic Components

Click to view similar products for [ESD Suppressors / TVS Diodes](#) category:

Click to view products by [Wild Goose](#) manufacturer:

Other Similar products are found below :

[60KS200C](#) [D18V0L1B2LP-7B](#) [D5V0F4U5P5-7](#) [NTE4902](#) [P4KE27CA](#) [P6KE11CA](#) [P6KE8.2A](#) [SA60CA](#) [SA64CA](#) [SMBJ12CATR](#)
[SMBJ33CATR](#) [SMBJ6.5A](#) [SMBJ8.0A](#) [ESD101-B1-02ELS E6327](#) [ESD112-B1-02EL E6327](#) [ESD7451N2T5G](#) [19180-510](#) [CPDT-5V0USP-](#)
[HF](#) [3.0SMCJ33CA-F](#) [3.0SMCJ36A-F](#) [HSPC16701B02TP](#) [JANTX1N6126A](#) [D3V3Q1B2DLP3-7](#) [D55V0M1B2WS-7](#) [SCM1293A-04SO](#)
[ESD200-B1-CSP0201 E6327](#) [SM12-7](#) [CEN955 W/DATA](#) [VESD12A1A-HD1-GS08](#) [CPDQC5V0-HF](#) [D1213A-01LP4-7B](#) [ESD101-B1-02EL](#)
[E6327](#) [AOZ8808DI-03](#) [5KP15A](#) [5KP48A](#) [5KP90A](#) [ESD3V3D7-TP](#) [15KPA36A-LF](#) [P4KE56CA](#) [P4KE68A](#) [P4KE91CATR](#) [P6KE120A](#)
[P6KE13CA](#) [P6KE43CA](#) [P6KE6.8CA](#) [P6KE8.2](#) [P6SMBJ20CA](#) [JANTX1N6072A](#) [SR2835ESKG](#) [SA90CA](#)