



## 15 Amps Single Phase Silicon Bridge

 <p><b>WildGoose</b></p> <p>GBU15005-GBU1510</p> <p><b>Features:</b></p> <ul style="list-style-type: none"> <li><input type="checkbox"/> High surge current capability</li> <li><input type="checkbox"/> Ideal for printed circuit boards</li> <li><input type="checkbox"/> Plastic package has Underwriters Laboratory Flammability Classification 94V-0</li> </ul>	<p>GBU </p>  <p style="text-align: center;">- ~ ~ +</p>
--	---

**Absolute Maximum Ratings** (Ta=25°C unless otherwise noted)

Parameter	Symbol	GBU 15005	GBU 1501	GBU 1502	GBU 1504	GBU 1506	GBU 1508	GBU 1510	Unit
Maximum Reverse Peak Repetitive Voltage	$V_{RRM}$	50	100	200	400	600	800	1000	V
Maximum RMS Voltage	$V_{RMS}$	35	70	140	280	420	560	700	
Maximum DC Blocking Voltage	$V_{DC}$	50	100	200	400	600	800	1000	
Maximum Average Forward Rectified Current, @ Ta=50°C	$I_{(AV)}$	15.0							A
Peak Forward Surge Current 8.3ms single half sine wave superimposed on rated load (JEDEC Method)	$I_{FSM}$	240							
Rating for fusing (t < 8.3ms)	$I^2t$	239							A <sup>2</sup> s
Maximum Reverse Current @ rated $V_R$ T <sub>j</sub> = 25°C T <sub>j</sub> = 125°C	$I_R$	10 500							μA
Maximum Forward Voltage @ 15.0 A	$V_F$	1.1							V
Typical Thermal Resistance	$R_{\theta JA}$	8							°C/W
Typical Junction Capacitance @ $V_R = 4.0$ V, f = 1.0 MHz	$C_j$	70							pF
Operating and Storage Temperature Range	T <sub>j</sub> , T <sub>stg</sub>	-55 to +150							°C

15 Amps Single Phase Silicon Bridge

Typical Characteristics

Fig. 1 - Forward Current Derating Curve

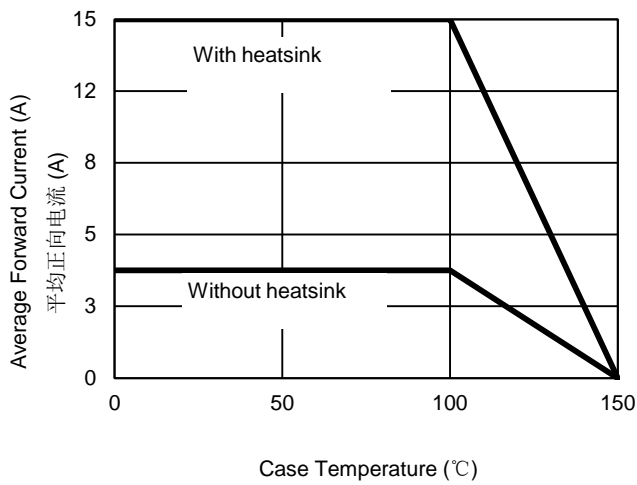

Fig. 2 - Maximum Non-Repetitive Surge Current

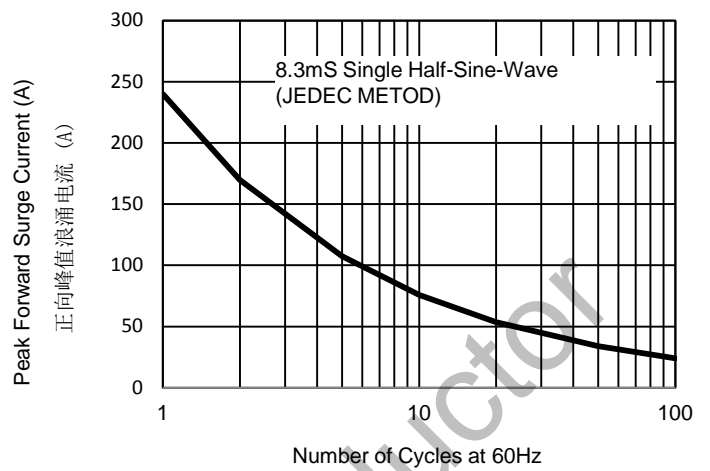

Fig. 3 - Typical Reverse Characteristics

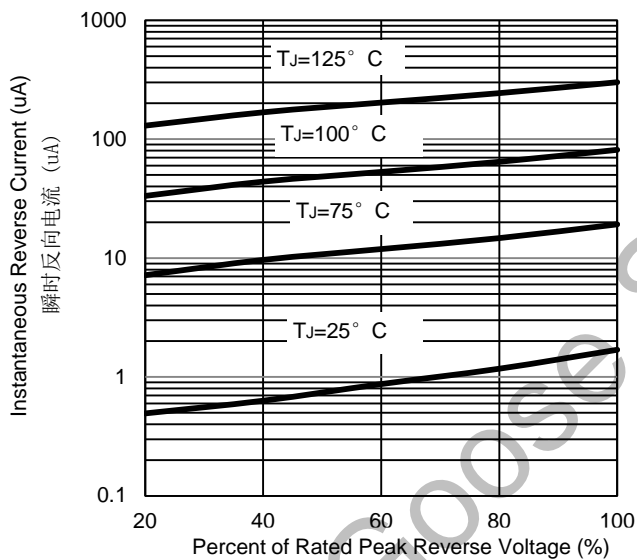

Fig. 4 - Typical Forward Characteristics

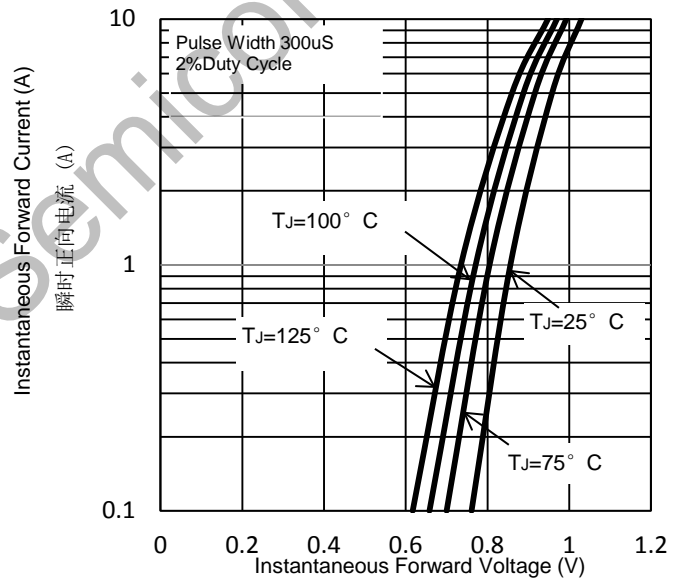
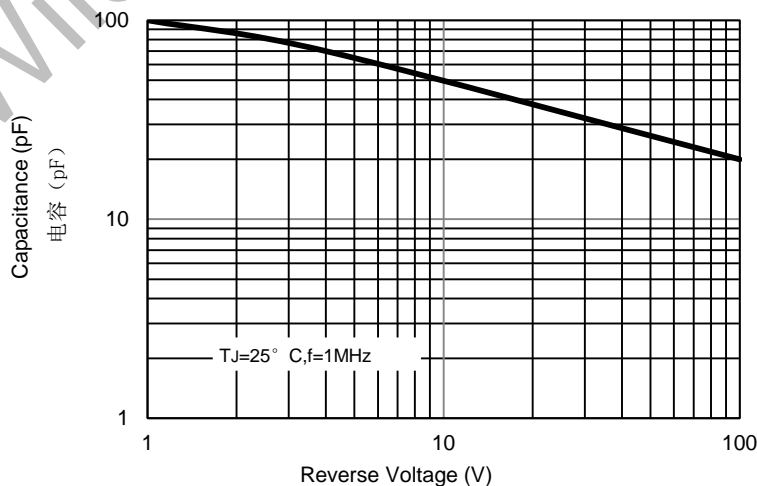
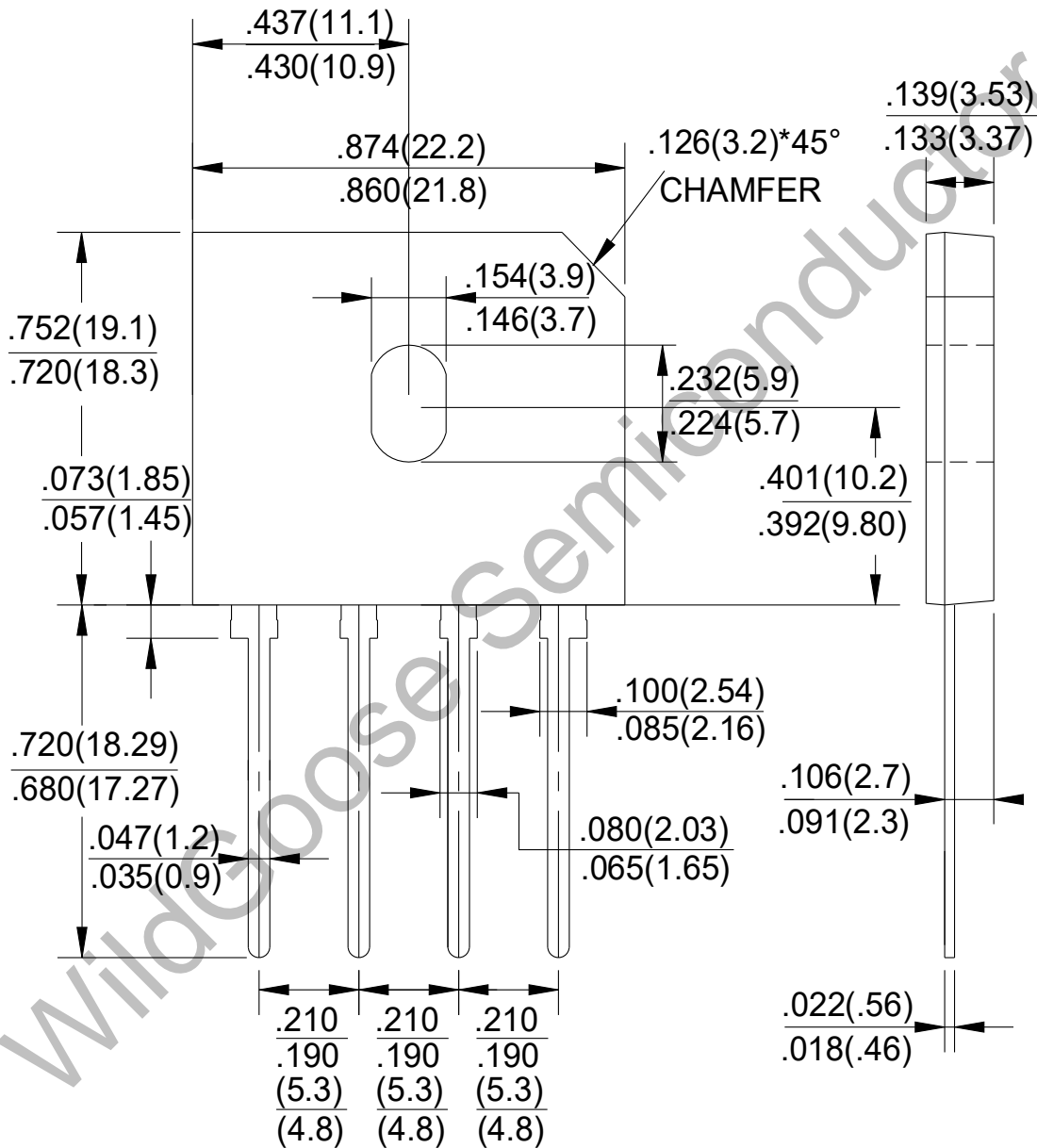

Fig. 5 - Typical Junction Capacitance



Package Dimension

**GBU**



Dimensions in inches and (millimeters)

## X-ON Electronics

Largest Supplier of Electrical and Electronic Components

*Click to view similar products for [Bridge Rectifiers](#) category:*

*Click to view products by [Wild Goose](#) manufacturer:*

Other Similar products are found below :

[MB252](#) [MB356G](#) [MB358G](#) [GBJ1504-BP](#) [GBU10B-BP](#) [GBU15K-BP](#) [GBU4A-BP](#) [GBU4D-BP](#) [DB101-BP](#) [DF01](#) [DF10SA-E345](#) [KBPC50-10S](#) [RS405GL-BP](#) [GBJ1502-BP](#) [GBU6M](#) [TB102M](#) [MB1510](#) [MB86](#) [TL401G](#) [MDA920A2](#) [TU602](#) [TU810](#) [MP5010W-BP](#) [MP501W-BP](#) [MP502-BP](#) [KBPC25-02](#) [VBO160-12NO7](#) [VS-110MT120KPBF](#) [VS-60MT80KPBF](#) [DB105-BP](#) [DF1510S](#) [VS-40MT160PAPBF](#) [GBU4G-BP](#) [GSIB15A80-E3/45](#) [DB104-BP](#) [D3SB60](#) [TB354](#) [GBJ2504-BP](#) [26MB100A](#) [B1S-G](#) [VS-40MT160KPBF](#) [VUO162-16NO7](#) [ABS10-G](#) [GBU6B-BP](#) [GBJ1508-BP](#) [BR5010-G](#) [ABS6-G](#) [B125C800G-E4/51](#) [MSB15MH-13](#) [LBS10-13](#)