



4 Amps Single Phase Silicon Bridge

 <p>GBU4005-GBU410</p> <p>Features:</p> <ul style="list-style-type: none"> <input type="checkbox"/> High surge current capability <input type="checkbox"/> Ideal for printed circuit boards <input type="checkbox"/> Plastic package has Underwriters Laboratory Flammability Classification 94V-0 	<p>GBU </p>  <p style="text-align: center;">- ~ ~ +</p>
---	---

Absolute Maximum Ratings (Ta=25°C unless otherwise noted)

Parameter	Symbol	GBU 4005	GBU 401	GBU 402	GBU 404	GBU 406	GBU 408	GBU 410	Unit
Maximum Reverse Peak Repetitive Voltage	V_{RRM}	50	100	200	400	600	800	1000	V
Maximum RMS Voltage	V_{RMS}	35	70	140	280	420	560	700	
Maximum DC Blocking Voltage	V_{DC}	50	100	200	400	600	800	1000	
Maximum Average Forward Rectified Current, @ Ta=50°C	$I_{(AV)}$	4.0							A
Peak Forward Surge Current 8.3ms single half sine wave superimposed on rated load (JEDEC Method)	I_{FSM}	150							
Rating for fusing (t < 8.3ms)	I^2t	93							A ² s
Maximum Reverse Current @ rated V_R T _j = 25°C T _j = 125°C	I_R	10 500							μA
Maximum Forward Voltage @ 4.0 A	V_F	1.0							V
Typical Thermal Resistance	$R_{\theta JA}$	2.2							°C/W
Typical Junction Capacitance @ $V_R = 4.0$ V, f = 1.0 MHz	C_j	45							pF
Operating and Storage Temperature Range	T _j , T _{stg}	-55 to +150							°C

4 Amps Single Phase Silicon Bridge

Typical Characteristics

FIG.1-FORWARD CURRENT DERATING CURVE

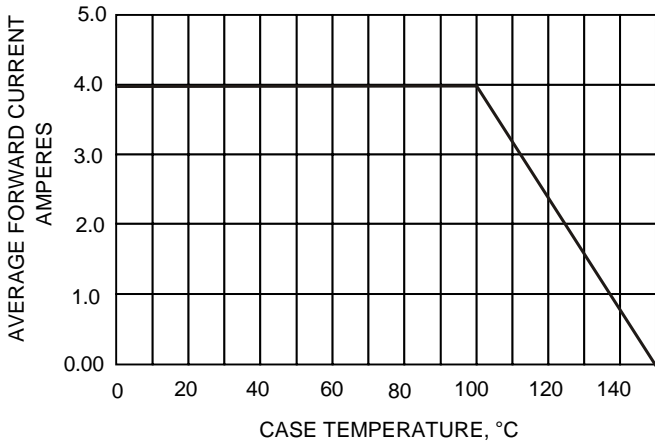

FIG.2-MAXIMUM NON-REPETITIVE SURGE CURRENT

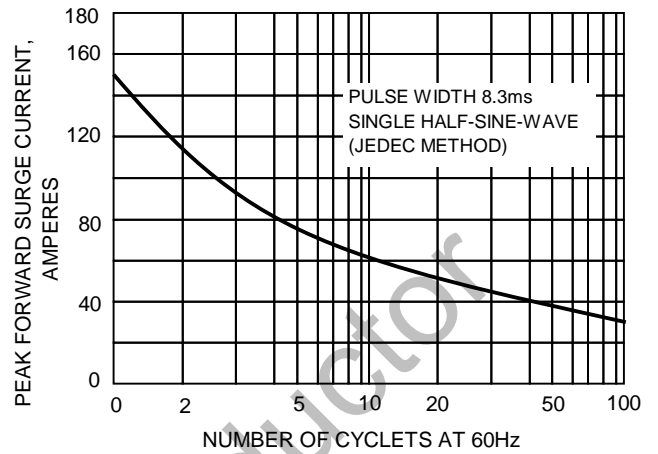

FIG.3-TYPICAL JUNCTION CAPACITANCE

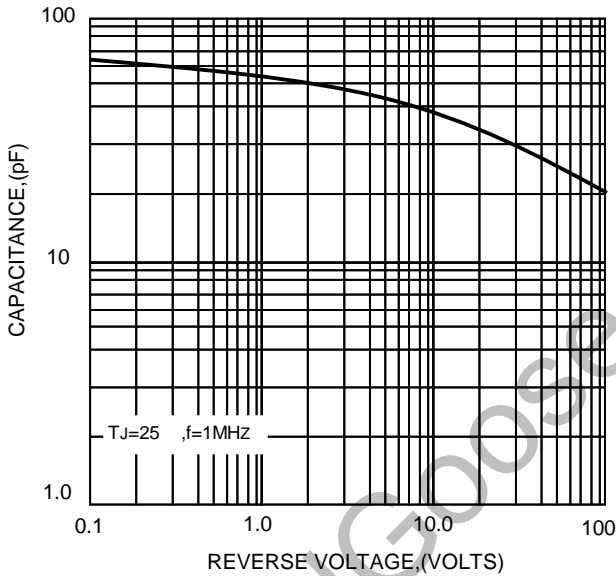

FIG.4-TYPICAL FORWARD CHARACTERISTICS

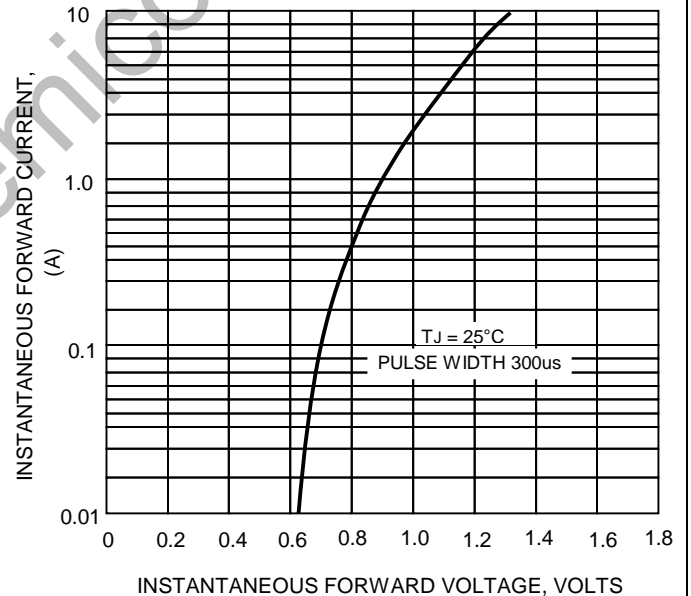
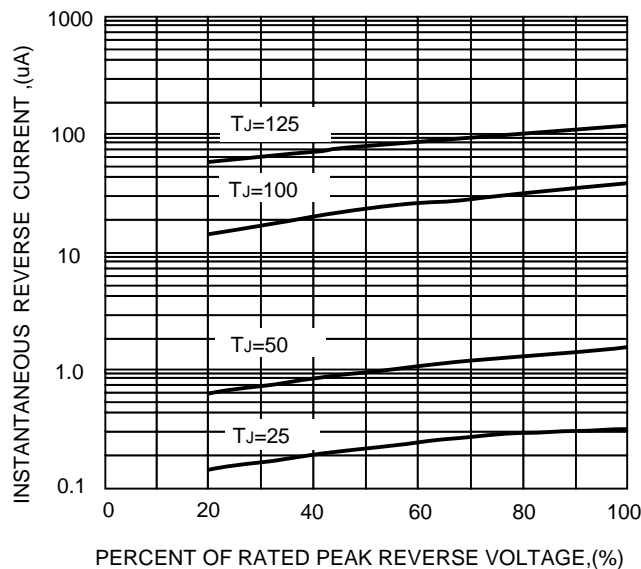
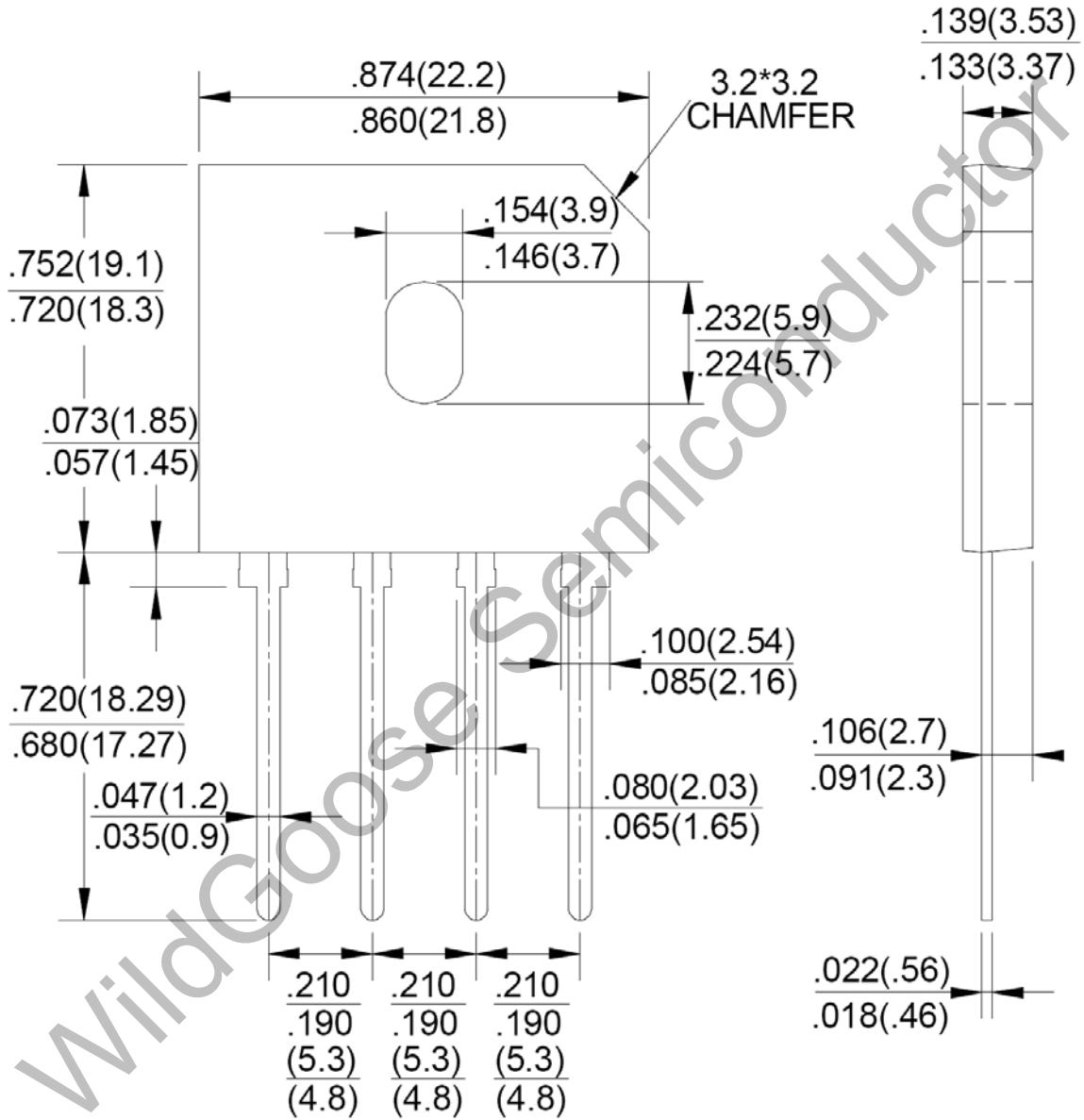

FIG.5-TYPICAL REVERSE CHARACTERISTICS



Package Dimension

GBU



Dimensions in inches and (millimeters)

X-ON Electronics

Largest Supplier of Electrical and Electronic Components

Click to view similar products for [Bridge Rectifiers](#) category:

Click to view products by [Wild Goose](#) manufacturer:

Other Similar products are found below :

[MB252](#) [MB356G](#) [MB358G](#) [GBJ1504-BP](#) [GBU10B-BP](#) [GBU15K-BP](#) [GBU4A-BP](#) [GBU4D-BP](#) [DB101-BP](#) [DF01](#) [DF10SA-E345](#) [KBPC50-10S](#) [RS405GL-BP](#) [GBJ1502-BP](#) [GBU6M](#) [TB102M](#) [MB1510](#) [MB86](#) [TL401G](#) [MDA920A2](#) [TU602](#) [TU810](#) [MP5010W-BP](#) [MP501W-BP](#) [MP502-BP](#) [KBPC25-02](#) [VBO160-12NO7](#) [VS-110MT120KPBF](#) [VS-60MT80KPBF](#) [DB105-BP](#) [DF1510S](#) [VS-40MT160PAPBF](#) [GBU4G-BP](#) [GSIB15A80-E3/45](#) [DB104-BP](#) [D3SB60](#) [TB354](#) [GBJ2504-BP](#) [26MB100A](#) [B1S-G](#) [VS-40MT160KPBF](#) [VUO162-16NO7](#) [ABS10-G](#) [GBU6B-BP](#) [GBJ1508-BP](#) [BR5010-G](#) [ABS6-G](#) [B125C800G-E4/51](#) [MSB15MH-13](#) [LBS10-13](#)