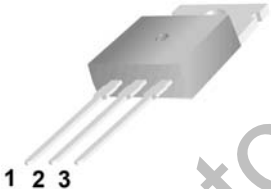
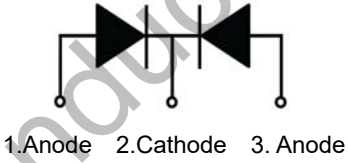
 <p>MBR2045SCT</p> <p>Features:</p> <ul style="list-style-type: none"> <input type="checkbox"/> Low power loss, high efficiency. High surge capacity <input type="checkbox"/> For use in low voltage, high frequency inverters, free wheeling, and polarity protection applications. <input type="checkbox"/> Metal silicon junction, majority carrier conduction. <input type="checkbox"/> High current Capability, low forward voltage drop. <input type="checkbox"/> Guard ring for over voltage protection. 	<p style="text-align: center;">TO-220</p>    <p style="text-align: center;">1.Anode 2.Cathode 3. Anode</p>
---	---

Absolute Maximum Ratings (Ta=25°C unless otherwise noted)

Parameter	Symbol	Value	Unit
Maximum Recurrent Peak Reverse Voltage	V_{RRM}	45	V
Maximum RMS Voltage	V_{RMS}	31.5	V
Maximum DC Blocking Voltage	$V_{R(DC)}$	45	V
Maximum Average Forward Current	$I_{F(AV)}$	20	A
Peak Forward Surge Current:8.3ms single half sine-wave superimposed on rated load (JEDEC method)	I_{FSM}	200	A
Maximum Forward Voltage @IF=10A	V_F	0.60	V
Maximum DC Reverse Current	I_R	0.02	mA
		20	mA
Maximum Operating Junction Temperature	T_j	150	°C
Storage Temperature	T_{stg}	-40~+150	°C

Typical Characteristics

RATING AND CHARACTERISTIC CURVES

FIG. 1- FORWARD CURRENT DERATING CURVE

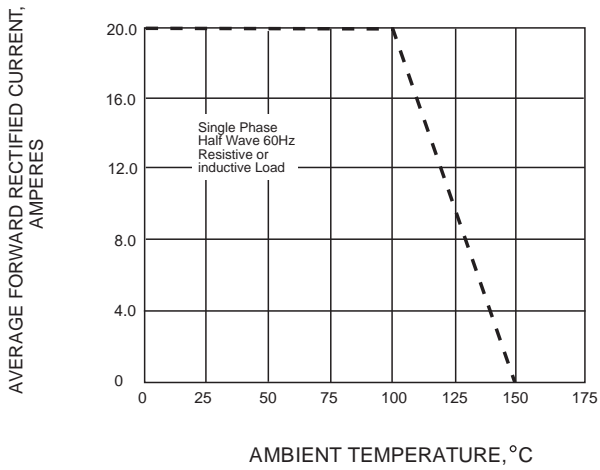

FIG. 2-MAXIMUM NON-REPETITIVE PEAK FORWARD SURGE CURRENT

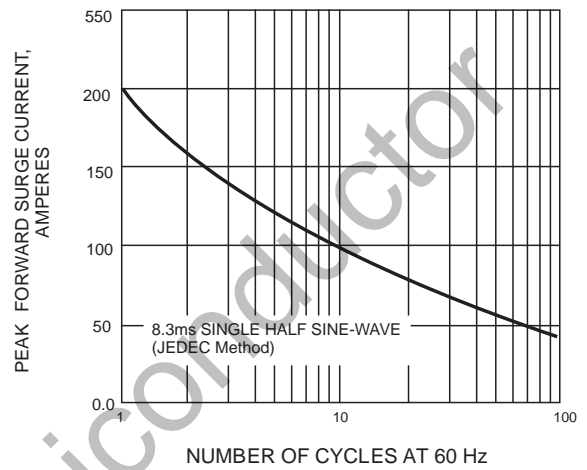

FIG. 3-TYPICAL INSTANTANEOUS FORWARD CHARACTERISTICS

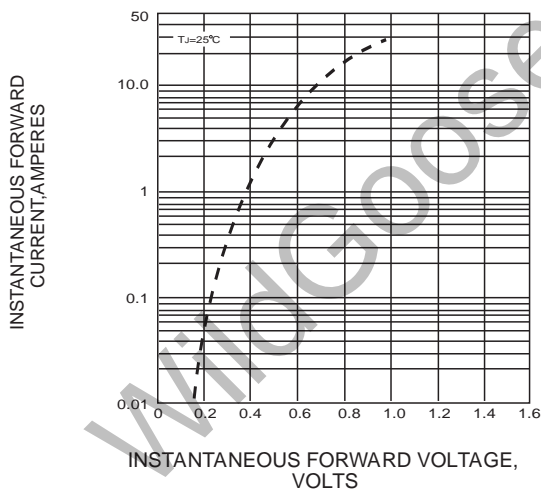
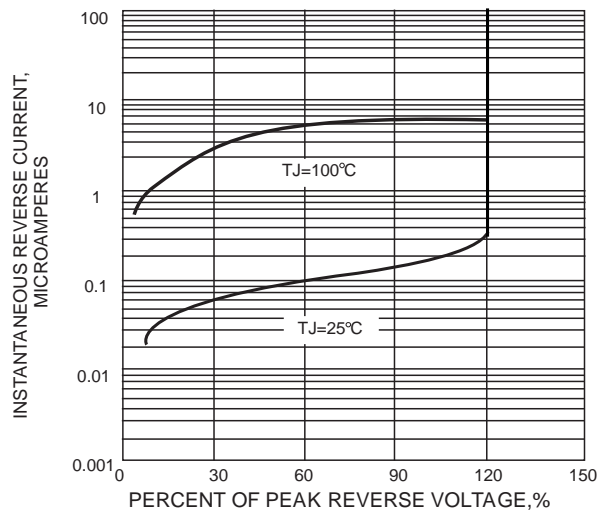
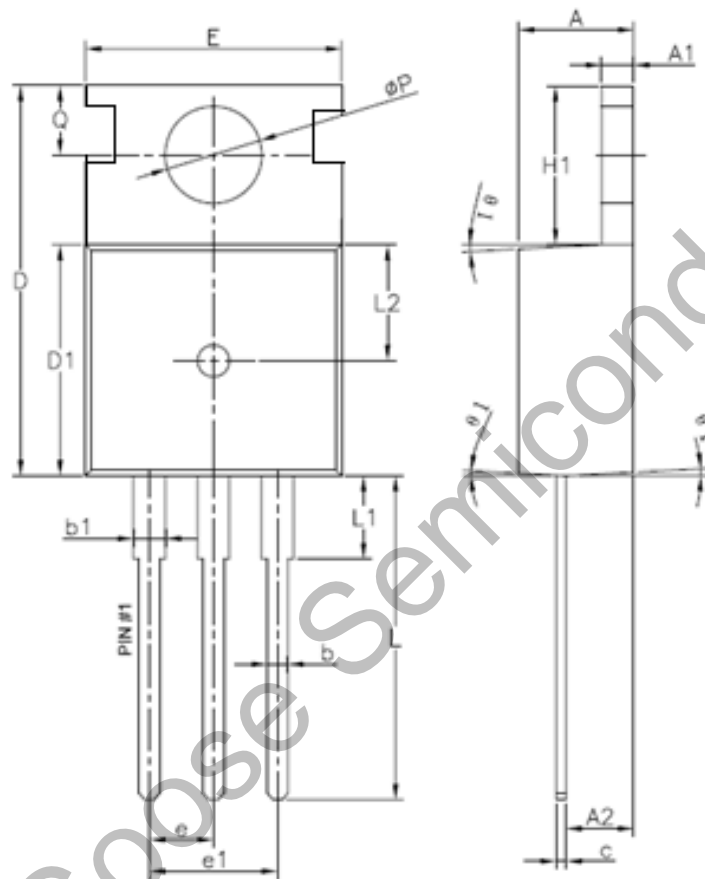

FIG. 4-TYPICAL REVERSE CHARACTERISTICS



Package Dimension

TO-220



Unit: mm

Symbol	Min	Normal	Max	Symbol	Min	Normal	Max
A	4.4	4.5	4.6	e		2.54	
A1	1.27	1.3	1.33	e1		5.08	
A2	2.3	2.4	2.5	H1	6.3	6.5	6.7
b	0.7	/	0.9	L	13.0	13.38	13.5
b1	1.25	/	1.42	L1	/	/	3.5
c	0.45	0.5	0.6	L2		4.6	
D	15.3	15.7	16.1	ΦP	3.55	3.6	3.65
D1	9.1	9.2	9.3	Q	2.73	/	2.87
E	9.7	9.9	10.2	θ_1 (°)	1	3	5

X-ON Electronics

Largest Supplier of Electrical and Electronic Components

Click to view similar products for [Schottky Diodes & Rectifiers](#) category:

Click to view products by [Wild Goose](#) manufacturer:

Other Similar products are found below :

[MA4E2039](#) [MMBD301M3T5G](#) [RB160M-50TR](#) [D83C](#) [BAS16E6433HTMA1](#) [BAS 3010S-02LRH E6327](#) [BAT 54-02LRH E6327](#)
[NRVBAF360T3G](#) [NSR05F40QNXT5G](#) [NTE555](#) [JANS1N6640](#) [SS3003CH-TL-E](#) [GA01SHT18](#) [CRS10I30A\(TE85L,QM](#) [MBRA140TRPBF](#)
[MBRB30H30CT-1G](#) [BAT 15-04R E6152](#) [JANTX1N5712-1](#) [DMJ3940-000](#) [SB007-03C-TB-E](#) [NRVBB20100CTT4G](#) [NRVBM120LT1G](#)
[NTSB30U100CT-1G](#) [CRG04\(T5L,TEMQ\)](#) [ACDBA1100LR-HF](#) [ACDBA1200-HF](#) [ACDBA240-HF](#) [ACDBA3100-HF](#) [CDBQC0530L-HF](#)
[ACDBA260LR-HF](#) [ACDBA1100-HF](#) [10BQ015-M3/5BT](#) [NRVBM120ET1G](#) [VSSB410S-M3/5BT](#) [1N5819T-G](#) [PDS1040Q-13](#) [B160BQ-13-F](#)
[SDM05U20CSP-7](#) [BAS 70-07 E6433](#) [B140S1F-7](#) [HSM560Je3/TR13](#) [DDB2265-000](#) [ZHCS506QTA](#) [HSM190Je3/TR13](#) [B330AF-13](#)
[ACDBUC0230-HF](#) [SDM1U100S1F-7](#) [MBR10200CTF-G1](#) [CDLL5712](#) [DMF2822-000](#)