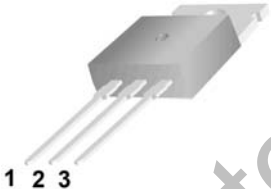
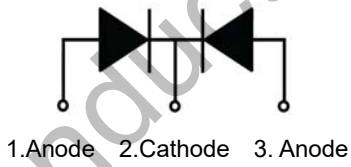
 <p><b>MBR30150SCT</b></p> <p><b>Features:</b></p> <ul style="list-style-type: none"> <li><input type="checkbox"/> Low power loss, high efficiency. High surge capacity</li> <li><input type="checkbox"/> For use in low voltage, high frequency inverters, free wheeling, and polarity protection applications.</li> <li><input type="checkbox"/> Metal silicon junction, majority carrier conduction.</li> <li><input type="checkbox"/> High current Capability, low forward voltage drop.</li> <li><input type="checkbox"/> Guard ring for over voltage protection.</li> </ul>	<p style="text-align: right;">TO-220 </p>  
--	--

**Absolute Maximum Ratings** (Ta=25°C unless otherwise noted)

Parameter	Symbol	Value	Unit
Maximum Recurrent Peak Reverse Voltage	$V_{RRM}$	150	V
Maximum RMS Voltage	$V_{RMS}$	105	V
Maximum DC Blocking Voltage	$V_{R(DC)}$	150	V
Maximum Average Forward Current	$I_{F(AV)}$	30	A
Peak Forward Surge Current:8.3ms single half sine-wave superimposed on rated load (JEDEC method)	$I_{FSM}$	200	A
Maximum Forward Voltage@15A	$V_F$	0.90	V
Maximum DC Reverse Current	Tj=25°C	0.1	mA
	Tj=125°C	15	mA
Maximum Operating Junction Temperature	$T_j$	175	°C
Storage Temperature	$T_{stg}$	-40~+175	°C

Typical Characteristics

RATING AND CHARACTERISTIC CURVES

FIG. 1- FORWARD CURRENT DERATING CURVE

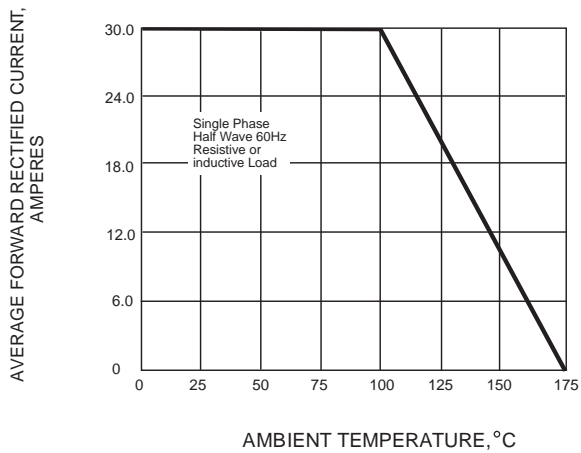

FIG. 2-MAXIMUM NON-REPETITIVE PEAK FORWARD SURGE CURRENT

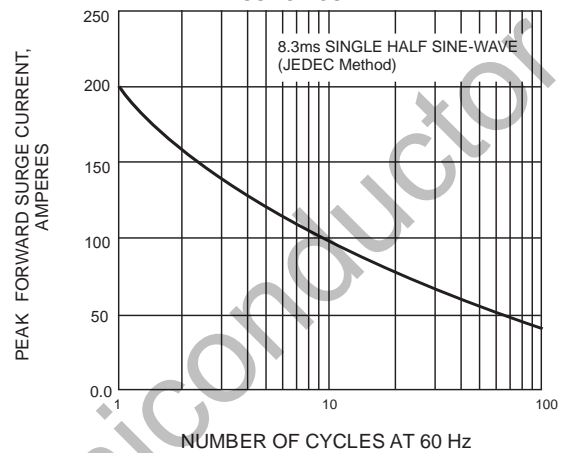

FIG. 3-TYPICAL INSTANTANEOUS FORWARD CHARACTERISTICS

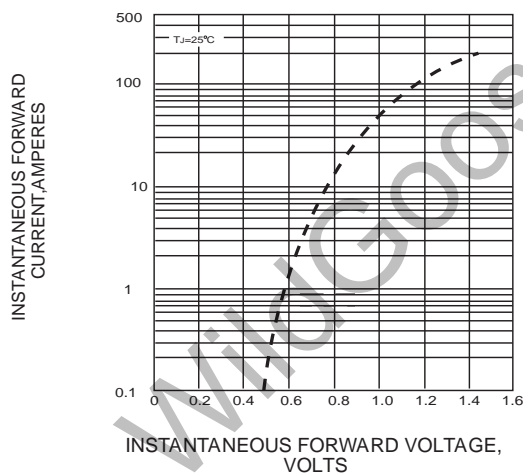
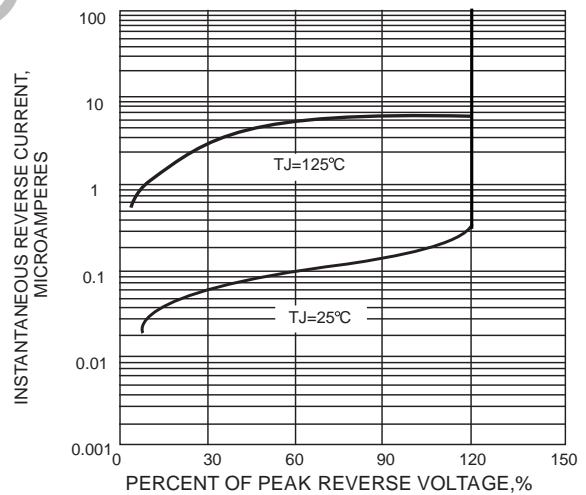
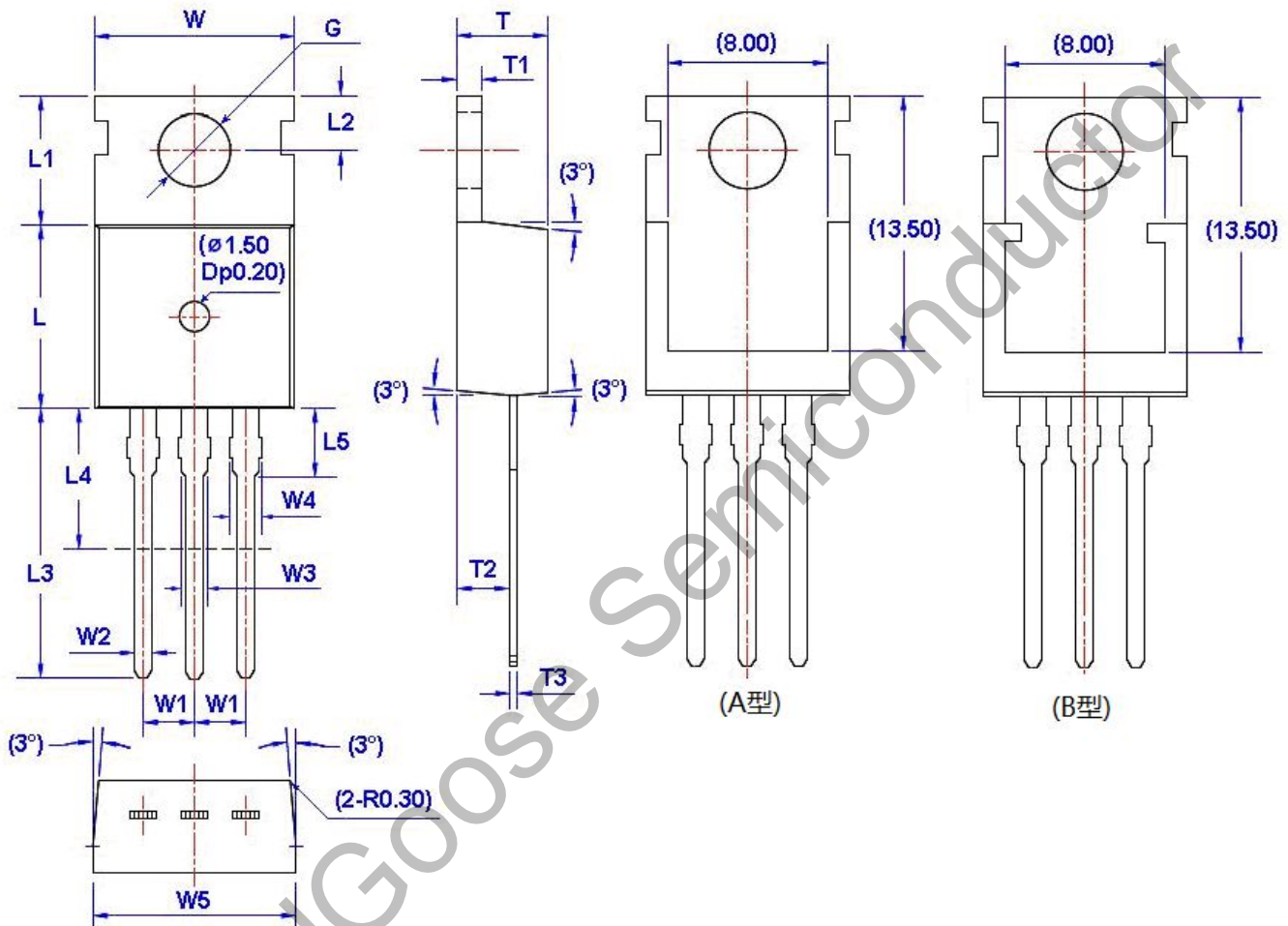

FIG. 4-TYPICAL REVERSE CHARACTERISTICS



**Package Dimension**

TO-220



Symbol	Size		Symbol	Size		Symbol	Size		Symbol	Size	
	Min	Max		Min	Max		Min	Max		Min	Max
W	9.66	10.28	W5	9.80	10.20	L4**	6.20	6.60	T3	0.45	0.60
W1	2.54 (TYP)		L	9.00	9.40	L5	2.79	3.30	G(Φ)	3.50	3.70
W2	0.70	0.95	L1	6.40	6.80	T	4.30	4.70			
W3	1.17	1.37	L2	2.70	2.90	T1	1.15	1.40			
W4*	1.32	1.72	L3	12.70	14.27	T2	2.20	2.60			

## X-ON Electronics

Largest Supplier of Electrical and Electronic Components

*Click to view similar products for [Schottky Diodes & Rectifiers](#) category:*

*Click to view products by [Wild Goose](#) manufacturer:*

Other Similar products are found below :

[MA4E2039](#) [MMBD301M3T5G](#) [RB160M-50TR](#) [D83C](#) [BAS16E6433HTMA1](#) [BAS 3010S-02LRH E6327](#) [BAT 54-02LRH E6327](#)  
[NRVBAF360T3G](#) [NSR05F40QNXT5G](#) [NTE555](#) [JANS1N6640](#) [SS3003CH-TL-E](#) [GA01SHT18](#) [CRS10I30A\(TE85L,QM](#) [MBRA140TRPBF](#)  
[MBRB30H30CT-1G](#) [BAT 15-04R E6152](#) [JANTX1N5712-1](#) [DMJ3940-000](#) [SB007-03C-TB-E](#) [NRVBB20100CTT4G](#) [NRVBM120LT1G](#)  
[NTSB30U100CT-1G](#) [CRG04\(T5L,TEMQ\)](#) [ACDBA1100LR-HF](#) [ACDBA1200-HF](#) [ACDBA240-HF](#) [ACDBA3100-HF](#) [CDBQC0530L-HF](#)  
[ACDBA260LR-HF](#) [ACDBA1100-HF](#) [10BQ015-M3/5BT](#) [NRVBM120ET1G](#) [VSSB410S-M3/5BT](#) [1N5819T-G](#) [PDS1040Q-13](#) [B160BQ-13-F](#)  
[SDM05U20CSP-7](#) [BAS 70-07 E6433](#) [B140S1F-7](#) [HSM560Je3/TR13](#) [DDB2265-000](#) [ZHCS506QTA](#) [HSM190Je3/TR13](#) [B330AF-13](#)  
[ACDBUC0230-HF](#) [SDM1U100S1F-7](#) [MBR10200CTF-G1](#) [CDLL5712](#) [DMF2822-000](#)