



30A SCHOTTKY BARRIER RECTIFIER



MBRD30150CT

Features:

- Low power loss, high efficiency.
High surge capacity
- For use in low voltage, high frequency inverters, free wheeling, and polarity protection applications.
- Metal silicon junction, majority carrier conduction.
- High current Capability, low forward voltage drop.
- Guard ring for over voltage protection.

TO-252 

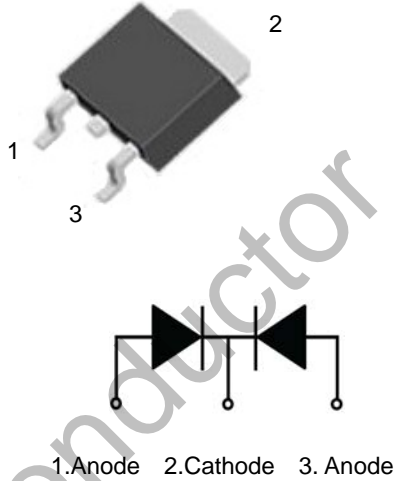

1.Anode 2.Cathode 3. Anode

Absolute Maximum Ratings (Ta=25°C unless otherwise noted)

Parameter	Symbol	Value	Unit
Maximum Recurrent Peak Reverse Voltage	V_{RRM}	150	V
Maximum RMS Voltage	V_{RMS}	105	V
Maximum DC Blocking Voltage	$V_{R(DC)}$	150	V
Maximum Average Forward Current	$I_{F(AV)}$	30	A
Peak Forward Surge Current:8.3ms single half sine-wave superimposed on rated load (JEDEC method)	I_{FSM}	350	A
Maximum Forward Voltage @IF=15A Tj=25°C	V_F	0.92	V
Maximum DC Reverse Current	I_R	Tj=25°C	0.1 mA
		Tj=125°C	20 mA
Maximum Operating Junction Temperature	T_j	150	°C
Storage Temperature	T_{stg}	-40~+150	°C

Typical Characteristics

RATING AND CHARACTERISTIC CURVES

FIG. 1- FORWARD CURRENT DERATING CURVE

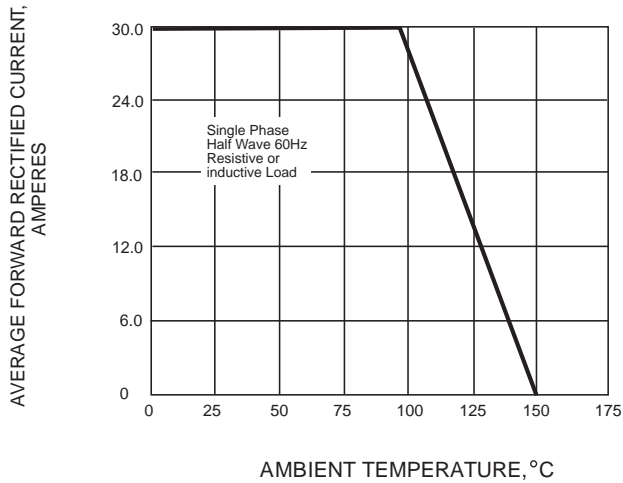

FIG. 2-MAXIMUM NON-REPETITIVE PEAK FORWARD SURGE CURRENT

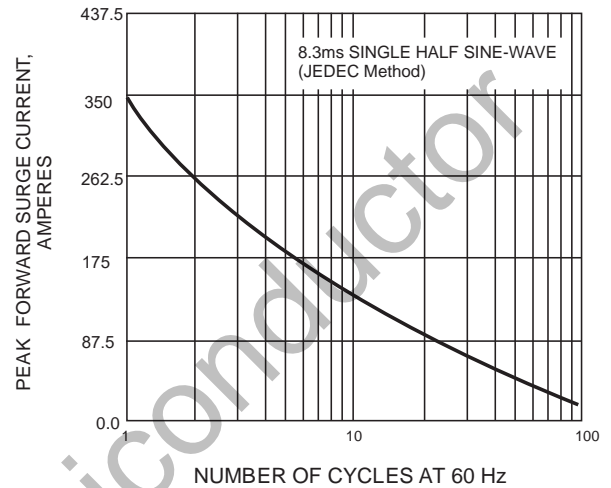

FIG. 3-TYPICAL INSTANTANEOUS FORWARD CHARACTERISTICS

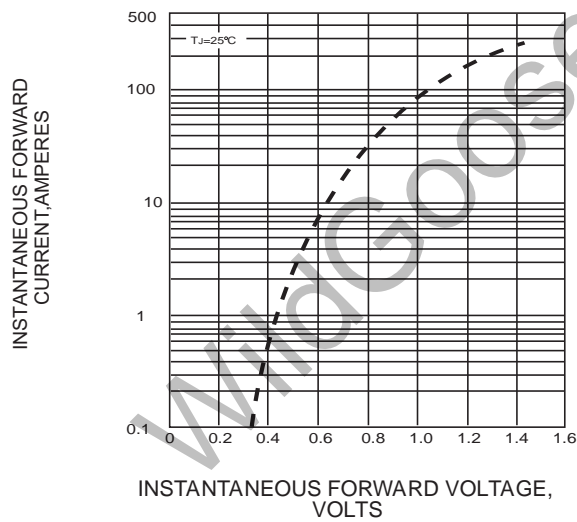
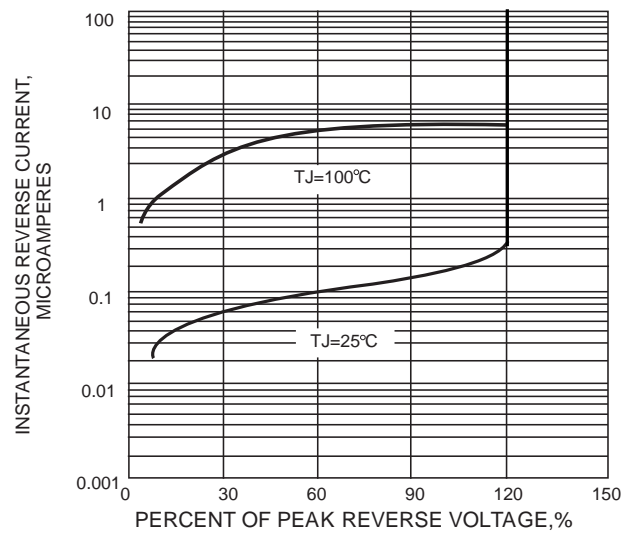

FIG. 4-TYPICAL REVERSE CHARACTERISTICS



Package Dimension

TO-252

Unit: mm

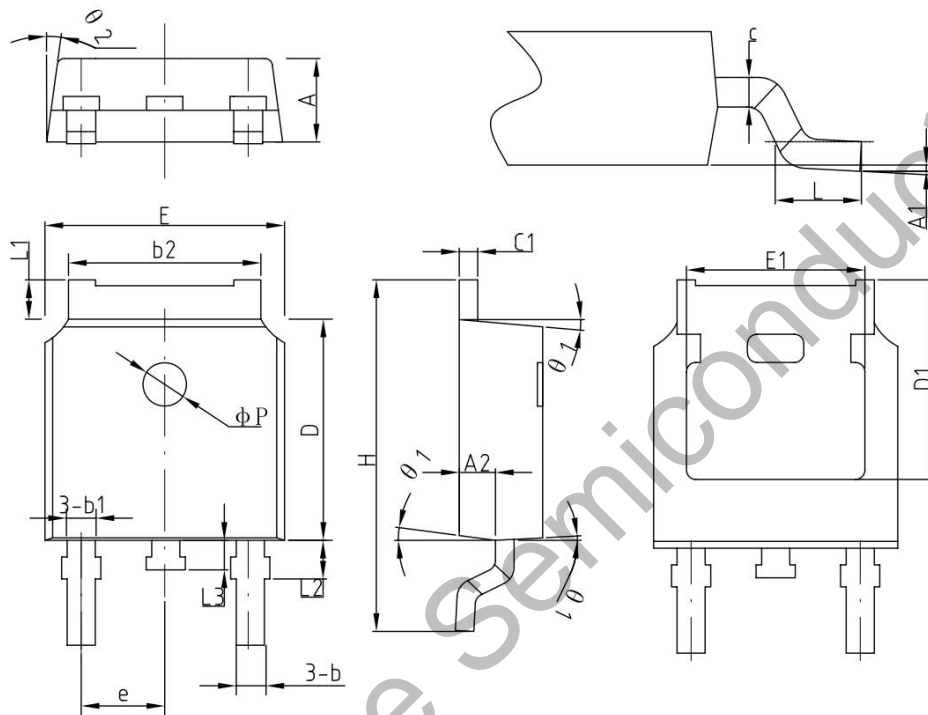

COMMON DIMENSIONS
(UNITS OF MEASURE=MILLIMETER)

SYMBOL	MIN	NOM	MAX
A	2.2	2.30	2.38
A1	0	—	0.10
A2	0.90	1.01	1.10
b	0.71	0.76	0.86
b1		0.76	
b2	5.13	5.33	5.46
c	0.47	0.50	0.60
c1	0.47	0.50	0.60
D	6.0	6.10	6.20
D1	—	5.30	—
E	6.50	6.60	6.70
E1	—	4.80	—
e	2.286BSC		
H	9.70	10.10	10.40
L	1.40	1.50	1.70
L1	0.90	—	1.25
L2		1.05	
L3		0.8	
φP		1.2	
θ	0°	—	8°
θ 1	5°	7°	9°
θ 2	5°	7°	9°

X-ON Electronics

Largest Supplier of Electrical and Electronic Components

Click to view similar products for [Schottky Diodes & Rectifiers](#) category:

Click to view products by [Wild Goose](#) manufacturer:

Other Similar products are found below :

[MA4E2039](#) [MMBD301M3T5G](#) [RB160M-50TR](#) [D83C](#) [BAS16E6433HTMA1](#) [BAS 3010S-02LRH E6327](#) [BAT 54-02LRH E6327](#)
[NRVBAF360T3G](#) [NSR05F40QNXT5G](#) [NTE555](#) [JANS1N6640](#) [SS3003CH-TL-E](#) [GA01SHT18](#) [CRS10I30A\(TE85L,QM](#) [MBRA140TRPBF](#)
[MBRB30H30CT-1G](#) [BAT 15-04R E6152](#) [JANTX1N5712-1](#) [DMJ3940-000](#) [SB007-03C-TB-E](#) [NRVBB20100CTT4G](#) [NRVBM120LT1G](#)
[NTSB30U100CT-1G](#) [CRG04\(T5L,TEMQ\)](#) [ACDBA1100LR-HF](#) [ACDBA1200-HF](#) [ACDBA240-HF](#) [ACDBA3100-HF](#) [CDBQC0530L-HF](#)
[ACDBA260LR-HF](#) [ACDBA1100-HF](#) [10BQ015-M3/5BT](#) [NRVBM120ET1G](#) [VSSB410S-M3/5BT](#) [1N5819T-G](#) [PDS1040Q-13](#) [B160BQ-13-F](#)
[SDM05U20CSP-7](#) [BAS 70-07 E6433](#) [B140S1F-7](#) [HSM560Je3/TR13](#) [DDB2265-000](#) [ZHCS506QTA](#) [HSM190Je3/TR13](#) [B330AF-13](#)
[ACDBUC0230-HF](#) [SDM1U100S1F-7](#) [MBR10200CTF-G1](#) [CDLL5712](#) [DMF2822-000](#)