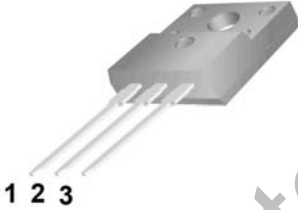

 <p style="font-size: 1.2em; font-weight: bold; margin-top: 20px;">MBRF20100SCT</p> <p>Features:</p> <ul style="list-style-type: none"> <input type="checkbox"/> Low power loss, high efficiency. High surge capacity <input type="checkbox"/> For use in low voltage, high frequency inverters, free wheeling, and polarity protection applications. <input type="checkbox"/> Metal silicon junction, majority carrier conduction. <input type="checkbox"/> High current Capability, low forward voltage drop. <input type="checkbox"/> Guard ring for over voltage protection. 	<div style="text-align: right;">  </div> <p style="text-align: center; font-weight: bold;">TO-220F</p>   <p style="text-align: center;">1. Anode 2. Cathode 3. Anode</p>
---	--

Absolute Maximum Ratings (Ta=25°C unless otherwise noted)

Parameter	Symbol	Value	Unit
Maximum Recurrent Peak Reverse Voltage	V_{RRM}	100	V
Maximum RMS Voltage	V_{RMS}	70	V
Maximum DC Blocking Voltage	$V_{R(DC)}$	100	V
Maximum Average Forward Current	$I_{F(AV)}$	20	A
Peak Forward Surge Current: 8.3ms single half sine-wave superimposed on rated load (JEDEC method)	I_{FSM}	180	A
Maximum Forward Voltage @10A	V_F	0.85	V
Maximum DC Reverse Current	$T_j=25^\circ\text{C}$	0.1	mA
	$T_j=125^\circ\text{C}$	20	mA
Maximum Operating Junction Temperature	T_j	150	°C
Storage Temperature	T_{stg}	-40~+150	°C

Typical Characteristics

RATING AND CHARACTERISTIC CURVES

FIG. 1- FORWARD CURRENT DERATING CURVE

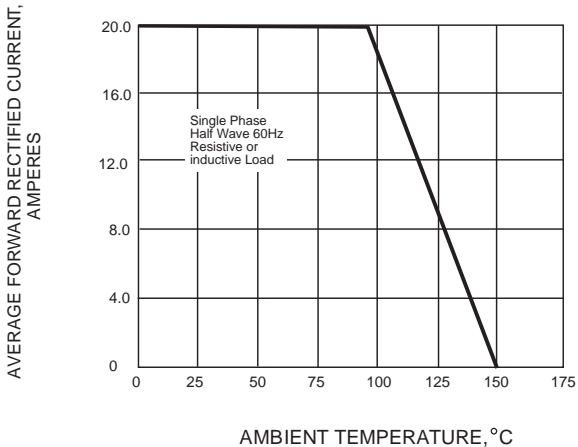

FIG. 2-MAXIMUM NON-REPETITIVE PEAK FORWARD SURGE CURRENT

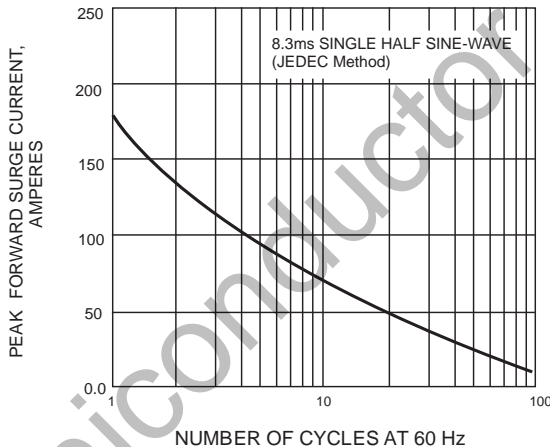

FIG. 3-TYPICAL INSTANTANEOUS FORWARD CHARACTERISTICS

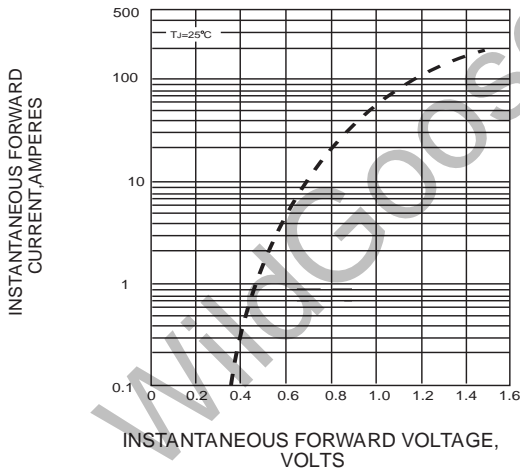
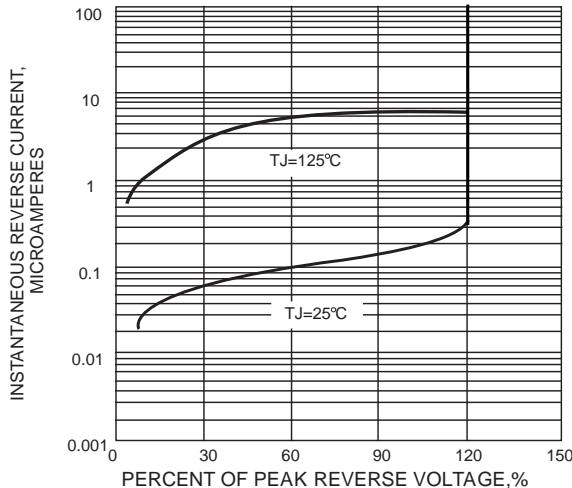

FIG. 4-TYPICAL REVERSE CHARACTERISTICS



Package Dimension

TO-220F

Unit: mm

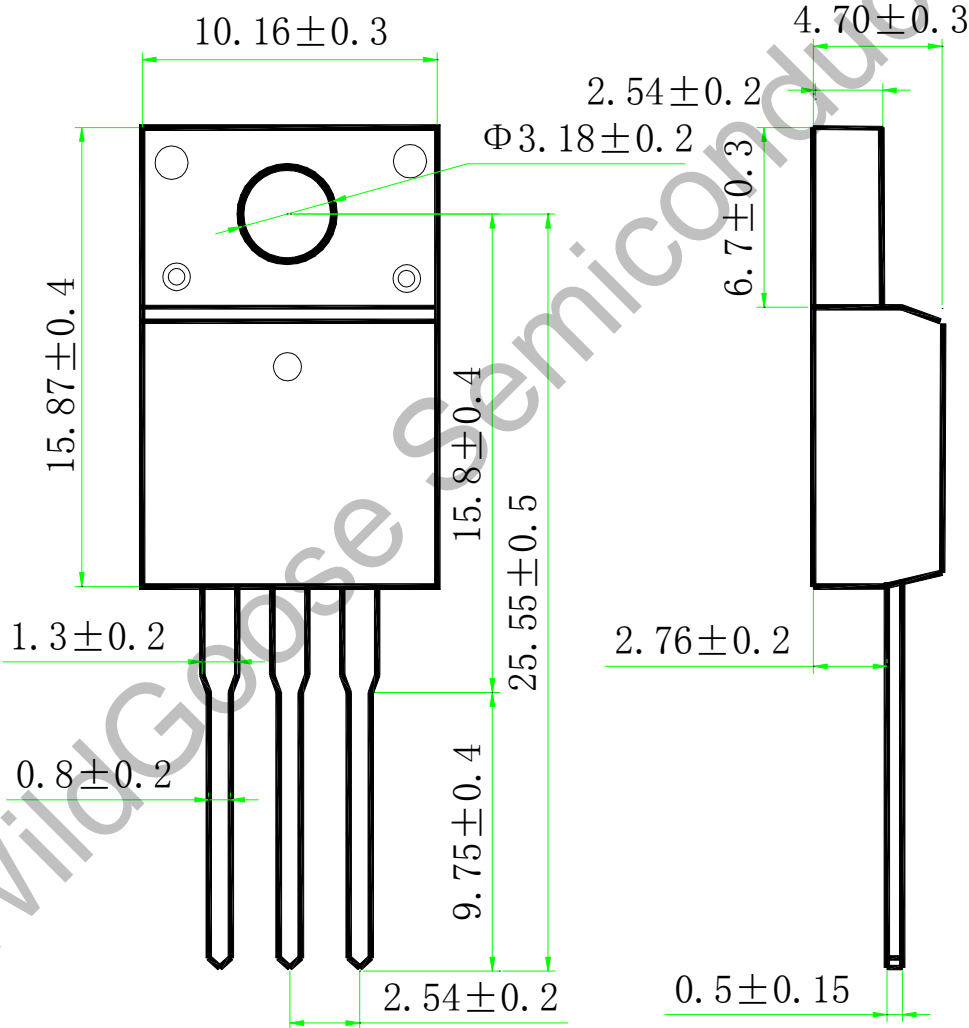

X-ON Electronics

Largest Supplier of Electrical and Electronic Components

Click to view similar products for [Schottky Diodes & Rectifiers](#) category:

Click to view products by [Wild Goose](#) manufacturer:

Other Similar products are found below :

[MA4E2039](#) [MMBD301M3T5G](#) [RB160M-50TR](#) [D83C](#) [BAS16E6433HTMA1](#) [BAS 3010S-02LRH E6327](#) [BAT 54-02LRH E6327](#)
[NRVBAF360T3G](#) [NSR05F40QNXT5G](#) [NTE555](#) [JANS1N6640](#) [SS3003CH-TL-E](#) [GA01SHT18](#) [CRS10I30A\(TE85L,QM](#) [MBRA140TRPBF](#)
[MBRB30H30CT-1G](#) [BAT 15-04R E6152](#) [JANTX1N5712-1](#) [DMJ3940-000](#) [SB007-03C-TB-E](#) [NRVBB20100CTT4G](#) [NRVBM120LT1G](#)
[NTSB30U100CT-1G](#) [CRG04\(T5L,TEMQ\)](#) [ACDBA1100LR-HF](#) [ACDBA1200-HF](#) [ACDBA240-HF](#) [ACDBA3100-HF](#) [CDBQC0530L-HF](#)
[ACDBA260LR-HF](#) [ACDBA1100-HF](#) [10BQ015-M3/5BT](#) [NRVBM120ET1G](#) [VSSB410S-M3/5BT](#) [1N5819T-G](#) [PDS1040Q-13](#) [B160BQ-13-F](#)
[SDM05U20CSP-7](#) [BAS 70-07 E6433](#) [B140S1F-7](#) [HSM560Je3/TR13](#) [DDB2265-000](#) [ZHCS506QTA](#) [HSM190Je3/TR13](#) [B330AF-13](#)
[ACDBUC0230-HF](#) [SDM1U100S1F-7](#) [MBR10200CTF-G1](#) [CDLL5712](#) [DMF2822-000](#)