



**MUR2005CTR-MUR2060CTR**

**Features:**

- High surge capacity
- Low Forward Voltage Drop.
- High Current Capability.
- Super Fast Switching Speed For High Efficiency



TO-220

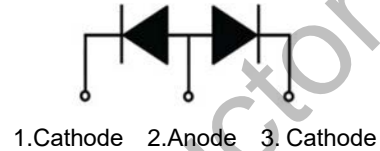
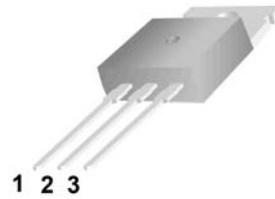

**Absolute Maximum Ratings** (Ta=25°C unless otherwise noted)

Parameter	Symbol	MUR 2005CTR	MUR 2010CTR	MUR 2015CTR	MUR 2020CTR	MUR 2030CTR	MUR 2040CTR	MUR 2060CTR	Unit
Maximum recurrent peak reverse voltage	V <sub>RRM</sub>	50	100	150	200	300	400	600	V
Maximum RMS Voltage	V <sub>RMS</sub>	35	70	105	140	210	280	420	V
Maximum DC Blocking Voltage	V <sub>R(DC)</sub>	50	100	150	200	300	400	600	V
Average Rectified Forward Current Total Device, (Rated V <sub>R</sub> ),	I <sub>F(AV)</sub>	20							A
Nonrepetitive Peak Surge Current(Surge applied at rated load conditions half wave, single phase, 60 Hz)	I <sub>FSM</sub>	200							A
Operating Junction Temperature and Storage Temperature	T <sub>J</sub> , T <sub>stg</sub>	-55 to +150							°C
Maximum Thermal Resistance, Junction-to-Case	R <sub>θJC</sub>	3.0				2.0			°C/W

**ELECTRICAL CHARACTERISTICS(per Leg)**

Parameter	Symbol	MUR 2005CTR	MUR 2010CTR	MUR 2015CTR	MUR 2020CTR	MUR 2030CTR	MUR 2040CTR	MUR 2060CTR	Unit
Forward Voltage (I <sub>F</sub> = 10A, T <sub>C</sub> = 25°C) (Note 1) (I <sub>F</sub> = 10 A, T <sub>C</sub> = 125°C)	V <sub>F</sub>	0.975 0.895			1.30 1.10		1.70 1.50		V
Maximum Instantaneous Reverse Current (Note 1) (Rated DC Voltage, T <sub>C</sub> = 25°C) (Rated DC Voltage, T <sub>C</sub> = 125°C)	I <sub>R</sub>	5 250			10 500				μA
Maximum Reverse Recovery Time (I <sub>F</sub> = 0.5 A, I <sub>R</sub> = 1.0 A, I <sub>REC</sub> = 0.25 A)	T <sub>RR</sub>	35							ns

Note 1.Pulse Test: Pulse Width = 300 μs, Duty Cycle ≤2.0%

Typical Characteristics

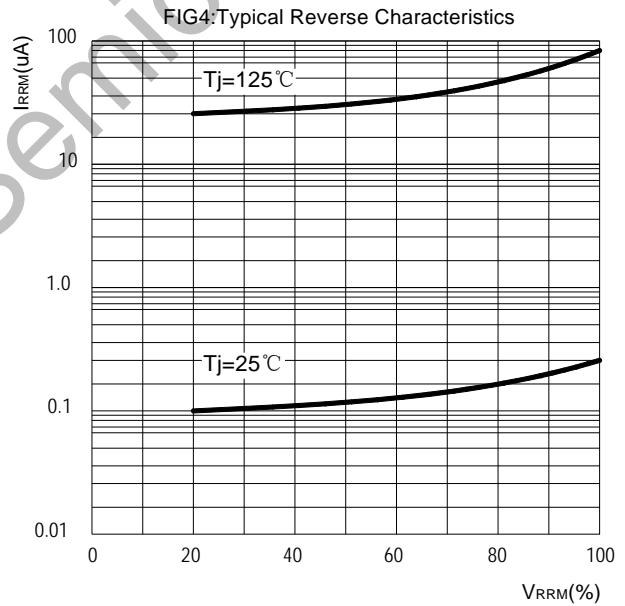
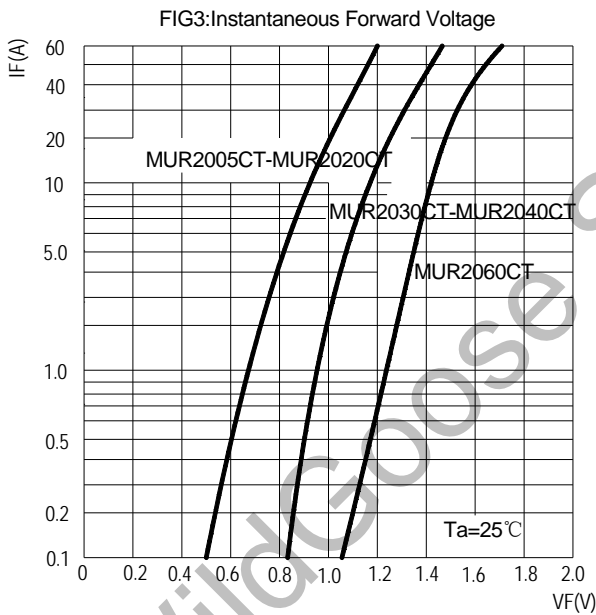
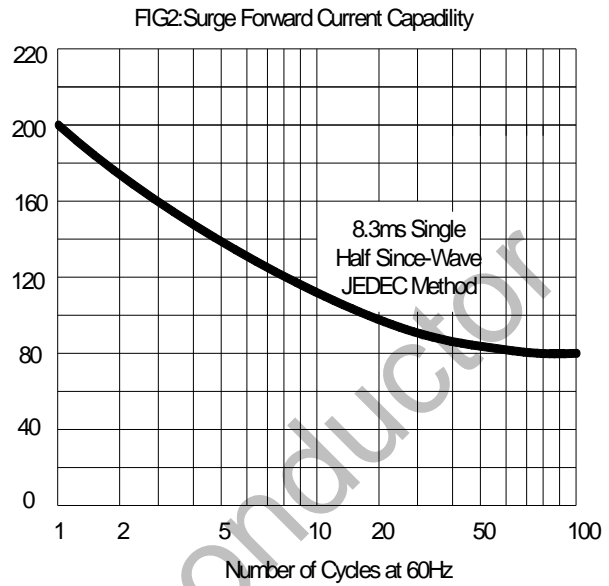
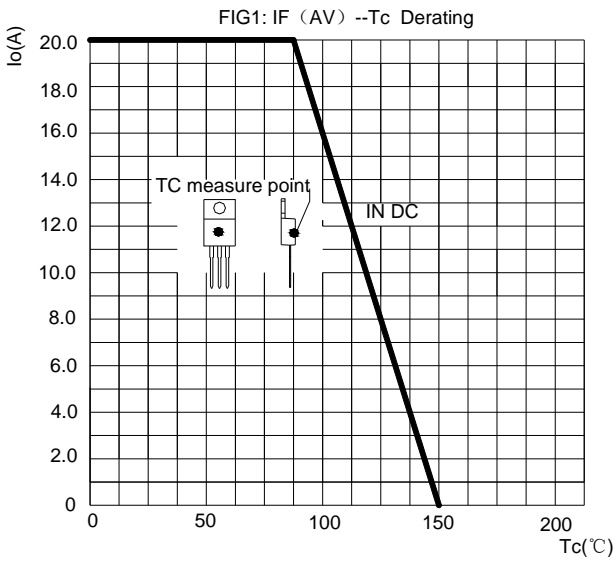
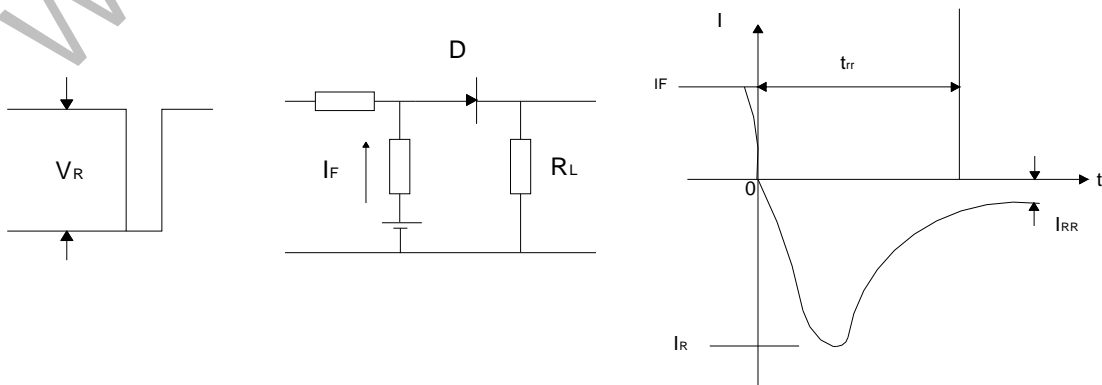
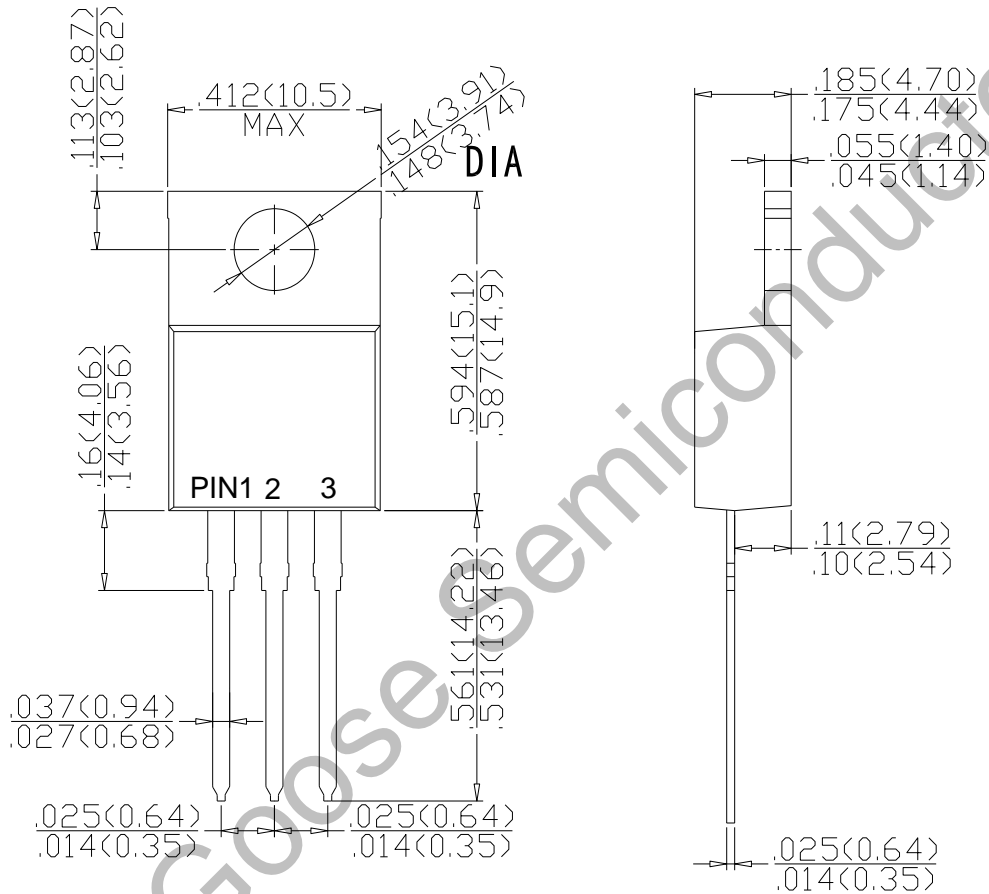

FIG.5: Diagram of circuit and Testing wave form of reverse recovery time



**Package Dimension**

TO-220



Dimensions in inches and (millimeters)

## X-ON Electronics

Largest Supplier of Electrical and Electronic Components

*Click to view similar products for [Rectifiers](#) category:*

*Click to view products by [Wild Goose](#) manufacturer:*

Other Similar products are found below :

[70HFR40](#) [FR105 R0](#) [RL252-TP](#) [1N5397](#) [1N4005-TR](#) [1N4007-BP](#) [UFS120Je3/TR13](#) [20ETS12S](#) [RRE02VS6SGTR](#) [MS306](#) [A1N5404G-G](#)  
[CRF02\(T5L,TEMQ\)](#) [ACGRB207-HF](#) [CLH07\(TE16L,Q\)](#) [CLH03\(TE16L,Q\)](#) [1N5395-TP](#) [UES1302](#) [ACGRC307-HF](#) [ACEFC304-HF](#) [DZ-](#)  
[1380](#) [85HFR60](#) [40HFR60](#) [70HF120](#) [85HFR80](#) [SCF7500](#) [SM100](#) [ACGRA4001-HF](#) [SKN70/08](#) [NTE5819](#) [NTE5827](#) [NTE5828](#) [NTE5911](#)  
[NTE5915](#) [NTE6104](#) [NTE6163](#) [NTE6164](#) [NTE6165](#) [NTE6364](#) [TSD3G](#) [SET130312](#) [NRVUS110VT3G](#) [UES1106](#) [UES1306](#)  
[NRVUS240VT3G](#) [D5FE60-5063](#) [R4000GPS-TP](#) [D4015L56TP](#) [UES1306HR2](#) [FX20K120](#) [D20XB60-7101](#)