



MUR2005CTR-MUR2060CTR

Features:

- High surge capacity
- Low Forward Voltage Drop.
- High Current Capability.
- Super Fast Switching Speed For High Efficiency

TO-220

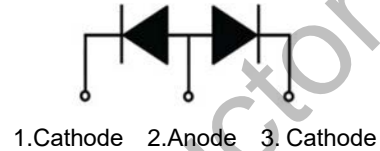
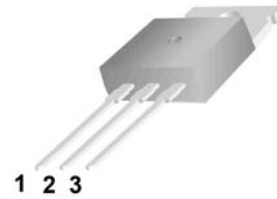

Absolute Maximum Ratings (Ta=25°C unless otherwise noted)

Parameter	Symbol	MUR 2005CTR	MUR 2010CTR	MUR 2015CTR	MUR 2020CTR	MUR 2030CTR	MUR 2040CTR	MUR 2060CTR	Unit
Maximum recurrent peak reverse voltage	V _{RRM}	50	100	150	200	300	400	600	V
Maximum RMS Voltage	V _{RMS}	35	70	105	140	210	280	420	V
Maximum DC Blocking Voltage	V _{R(DC)}	50	100	150	200	300	400	600	V
Average Rectified Forward Current Total Device, (Rated V _R),	I _{F(AV)}	20							A
Nonrepetitive Peak Surge Current(Surge applied at rated load conditions half wave, single phase, 60 Hz)	I _{FSM}	200							A
Operating Junction Temperature and Storage Temperature	T _J , T _{stg}	-55 to +150							°C
Maximum Thermal Resistance, Junction-to-Case	R _{θJC}	3.0				2.0			°C/W

ELECTRICAL CHARACTERISTICS(per Leg)

Parameter	Symbol	MUR 2005CTR	MUR 2010CTR	MUR 2015CTR	MUR 2020CTR	MUR 2030CTR	MUR 2040CTR	MUR 2060CTR	Unit
Forward Voltage (I _F = 10A, T _C = 25°C) (Note 1) (I _F = 10 A, T _C = 125°C)	V _F	0.975 0.895			1.30 1.10		1.70 1.50		V
Maximum Instantaneous Reverse Current (Note 1) (Rated DC Voltage, T _C = 25°C) (Rated DC Voltage, T _C = 125°C)	I _R	5 250			10 500				μA
Maximum Reverse Recovery Time (I _F = 0.5 A, I _R = 1.0 A, I _{REC} = 0.25 A)	T _{RR}	35							ns

Note 1.Pulse Test: Pulse Width = 300 μs, Duty Cycle ≤2.0%

Typical Characteristics

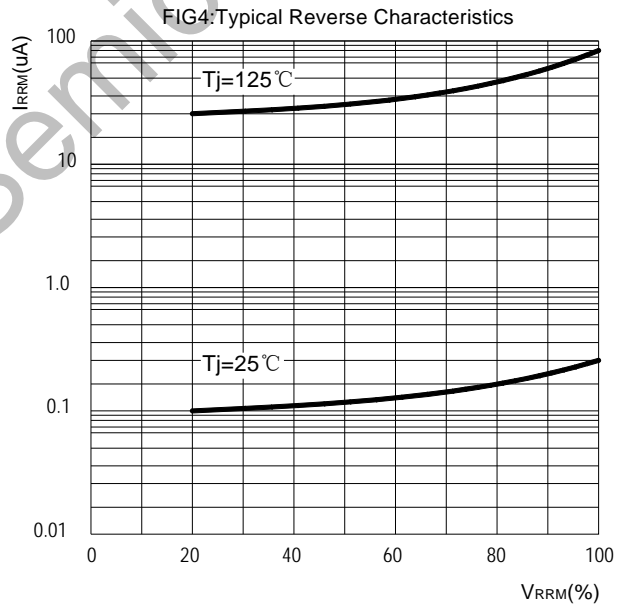
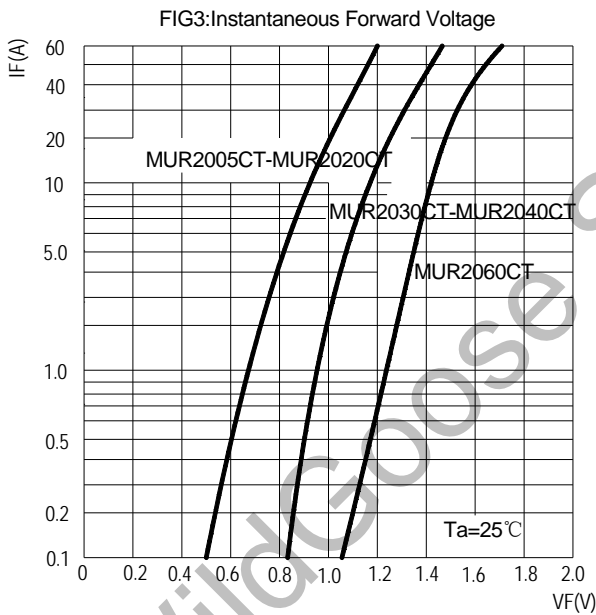
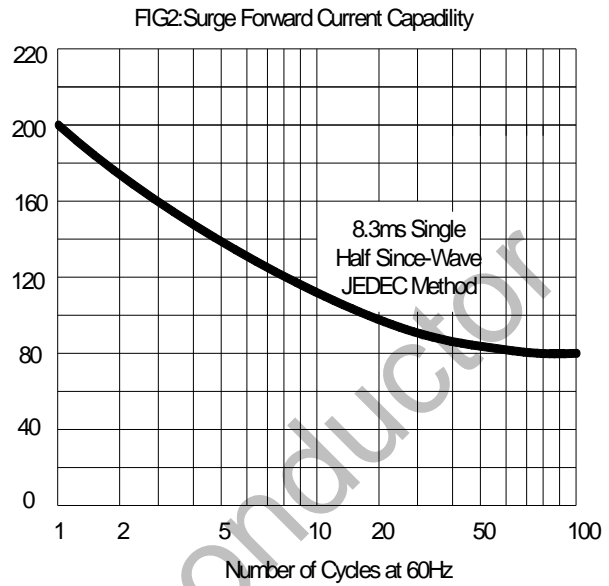
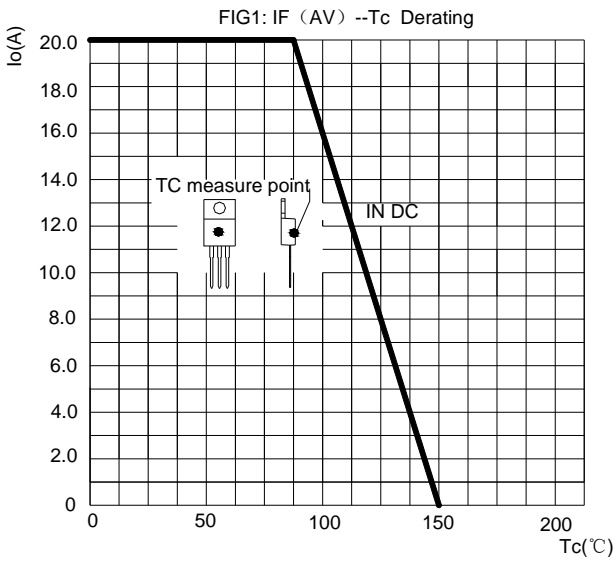
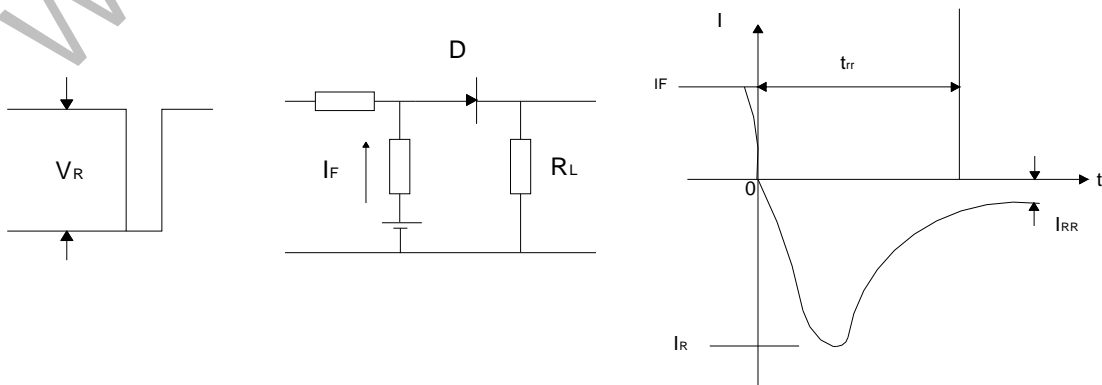
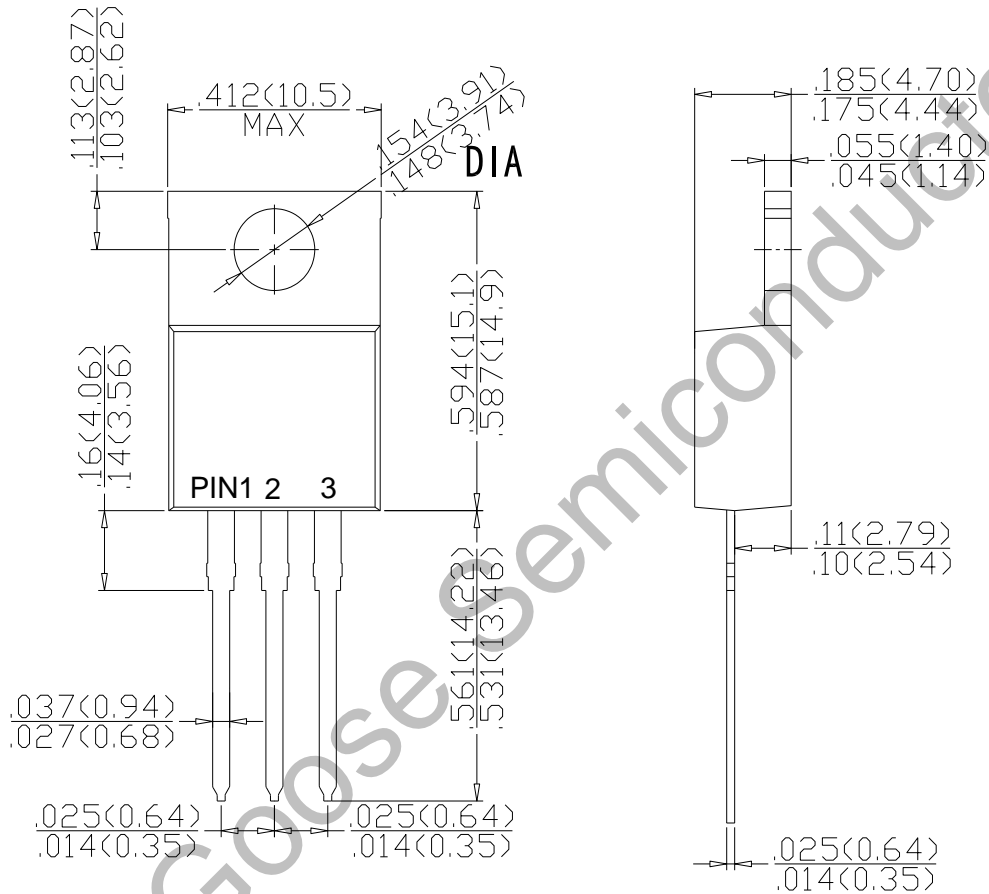

FIG.5: Diagram of circuit and Testing wave form of reverse recovery time



Package Dimension

TO-220



Dimensions in inches and (millimeters)

X-ON Electronics

Largest Supplier of Electrical and Electronic Components

Click to view similar products for [Rectifiers](#) category:

Click to view products by [Wild Goose](#) manufacturer:

Other Similar products are found below :

[70HFR40](#) [FR105 R0](#) [RL252-TP](#) [1N5397](#) [1N4005-TR](#) [1N4007-BP](#) [UFS120Je3/TR13](#) [20ETS12S](#) [RRE02VS6SGTR](#) [MS306](#) [A1N5404G-G](#)
[CRF02\(T5L,TEMQ\)](#) [ACGRB207-HF](#) [CLH07\(TE16L,Q\)](#) [CLH03\(TE16L,Q\)](#) [1N5395-TP](#) [UES1302](#) [ACGRC307-HF](#) [ACEFC304-HF](#) [DZ-](#)
[1380](#) [85HFR60](#) [40HFR60](#) [70HF120](#) [85HFR80](#) [SCF7500](#) [SM100](#) [ACGRA4001-HF](#) [SKN70/08](#) [NTE5819](#) [NTE5827](#) [NTE5828](#) [NTE5911](#)
[NTE5915](#) [NTE6104](#) [NTE6163](#) [NTE6164](#) [NTE6165](#) [NTE6364](#) [TSD3G](#) [SET130312](#) [NRVUS110VT3G](#) [UES1106](#) [UES1306](#)
[NRVUS240VT3G](#) [D5FE60-5063](#) [R4000GPS-TP](#) [D4015L56TP](#) [UES1306HR2](#) [FX20K120](#) [D20XB60-7101](#)