



MUR3010CT – MUR3060CT

30 Amps Super Fast Recovery

 <p>MUR3010CT – MUR3060CT</p> <p>Features:</p> <ul style="list-style-type: none"> <input type="checkbox"/> High surge capacity <input type="checkbox"/> Low Forward Voltage Drop. <input type="checkbox"/> High Current Capability. <input type="checkbox"/> Super Fast Switching Speed For High Efficiency 	<p style="text-align: center;">TO-220</p>   <p style="text-align: center;">1.Anode 2.Cathode 3. Anode</p>
--	--

Absolute Maximum Ratings (Ta=25°C unless otherwise noted)

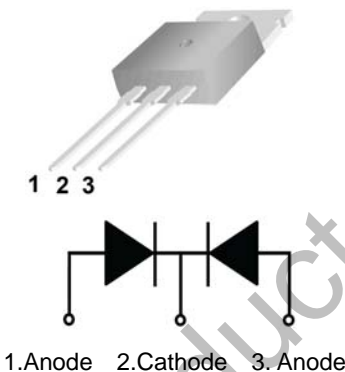
Parameter	Symbol	MUR 3010 CT	MUR 3015 CT	MUR 3020 CT	MUR 3040 CT	MUR 3060 CT	Unit
Peak Repetitive Reverse Voltage	V_{RRM}	100	150	200	400	600	V
Working Peak Reverse Voltage	V_{RWM}	100	150	200	400	600	V
DC Blocking Voltage	$V_{R(DC)}$	100	150	200	400	600	V
Average Rectified Forward Current Per Leg Total Device	$I_{F(AV)}$	15 30					A
Peak Rectified Forward Current (Rated V_R , Square Wave, 20 kHz)	I_{FM}	30					A
Nonrepetitive Peak Surge Current(Surge applied at rated load conditions half wave, single phase, 60 Hz)	I_{FSM}	240					A
Operating Junction Temperature and Storage Temperature	TJ, Tstg	-55 to +150					°C
Maximum Thermal Resistance, Junction-to-Case(Per Leg)	$R_{\theta JC}$	3.0			2.0		°C/W

ELECTRICAL CHARACTERISTICS (Per Diode Leg)

Parameter	Symbol	MUR 3010 CT	MUR 3015 CT	MUR 3020 CT	MUR 3040 CT	MUR 3060 CT	Unit
Forward Voltage (Note 1)($I_F = 15\text{ A}$, $T_C = 25^\circ\text{C}$) ($I_F = 15\text{ A}$, $T_C = 125^\circ\text{C}$)	V_F	0.975 0.895			1.35 1.20	1.70 1.50	V
Maximum Instantaneous Reverse Current (Note 1) (Rated DC Voltage, $T_C = 25^\circ\text{C}$) (Rated DC Voltage, $T_C = 125^\circ\text{C}$)	I_R	5 250			10 500		μA
Maximum Reverse Recovery Time ($I_F = 1.0\text{ A}$, $di/dt = 50\text{ A}/\mu\text{s}$) ($I_F = 0.5\text{ A}$, $I_R = 1.0\text{ A}$, $I_{REC} = 0.25\text{ A}$)	T_{RR}	35 25			35 30		ns

Note 1.Pulse Test: Pulse Width = 300 μs , Duty Cycle $\leq 2.0\%$

Typical Characteristics

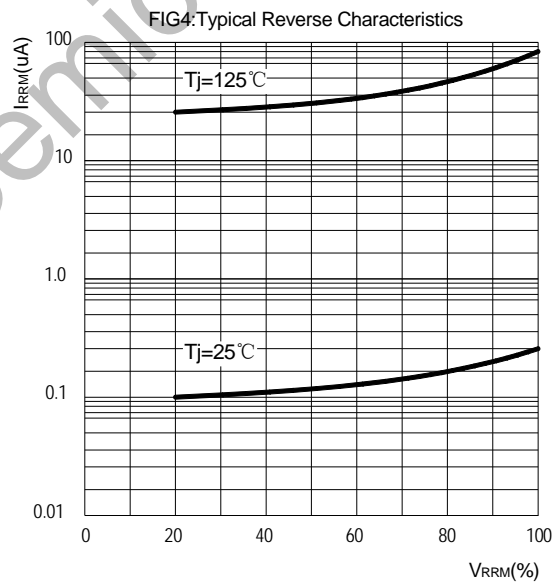
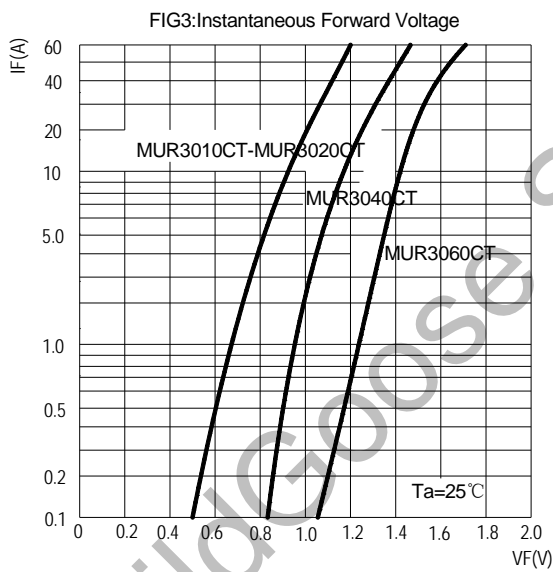
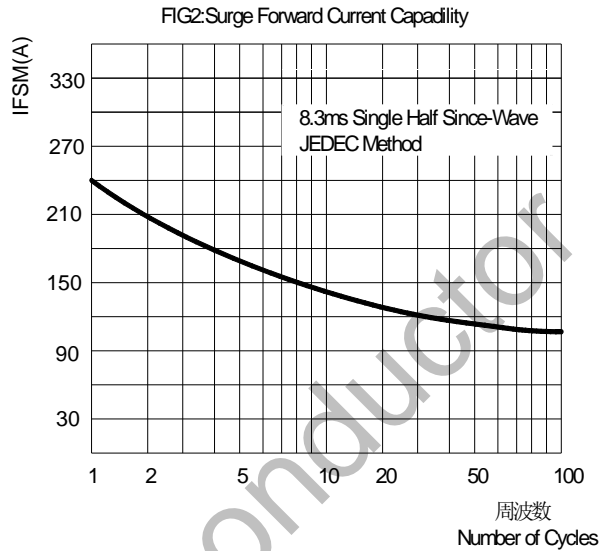
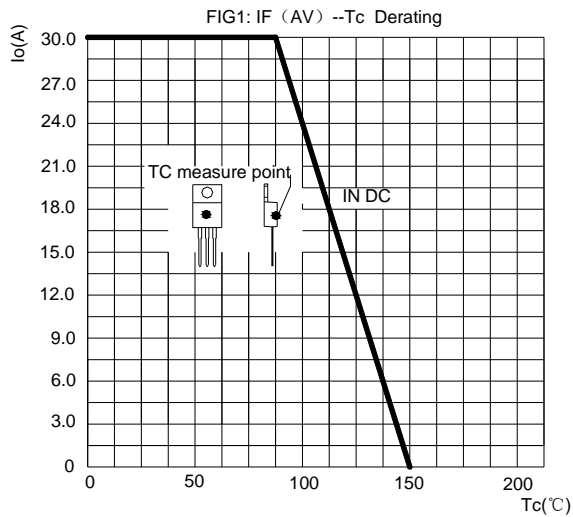
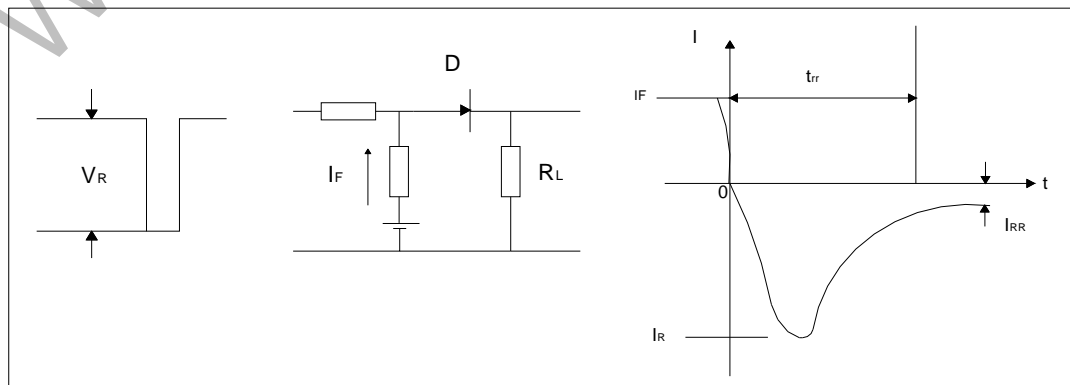

FIG.5: Diagram of circuit and Testing wave form of reverse recovery time



Package Dimension

TO-220

Unit: mm

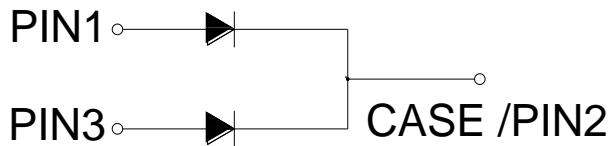
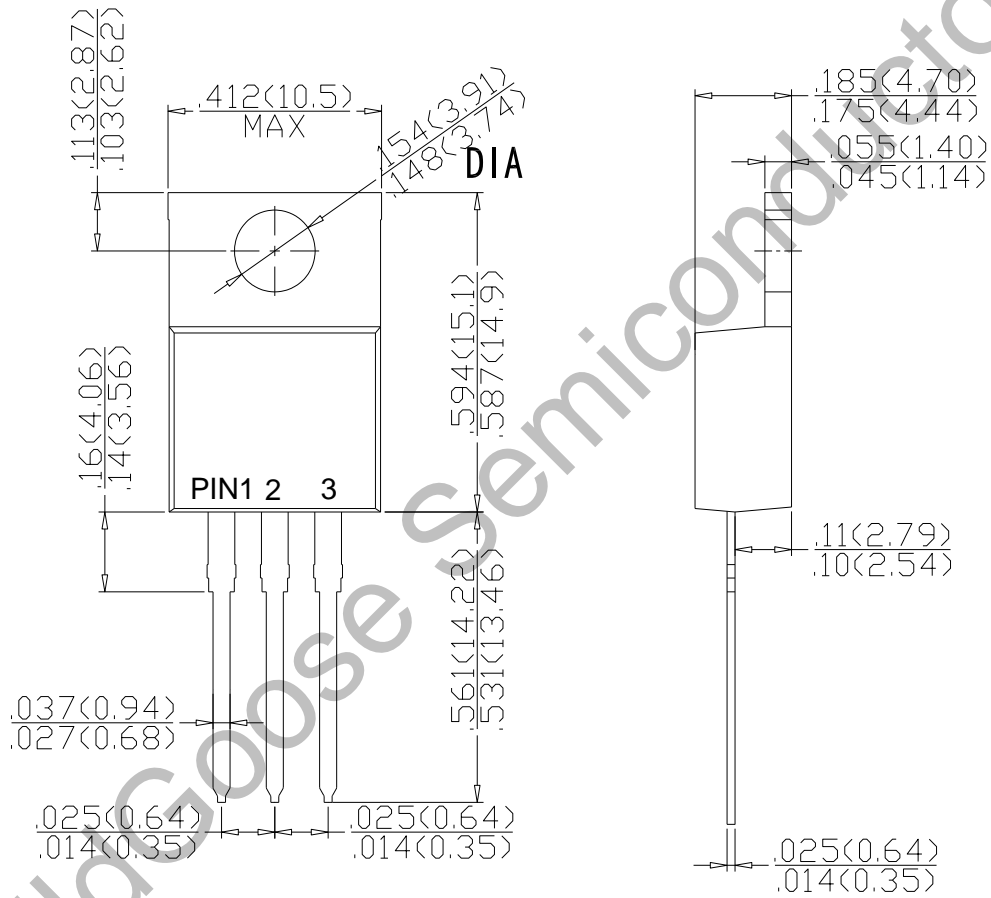

Dimensions in inches and (millimeters)

X-ON Electronics

Largest Supplier of Electrical and Electronic Components

Click to view similar products for [Rectifiers](#) category:

Click to view products by [Wild Goose](#) manufacturer:

Other Similar products are found below :

[70HFR40](#) [FR105 R0](#) [RL252-TP](#) [1N5397](#) [1N4005-TR](#) [1N4007-BP](#) [UFS120Je3/TR13](#) [20ETS12S](#) [RRE02VS6SGTR](#) [MS306](#) [A1N5404G-G](#)
[CRF02\(T5L,TEMQ\)](#) [ACGRB207-HF](#) [CLH07\(TE16L,Q\)](#) [CLH03\(TE16L,Q\)](#) [1N5395-TP](#) [UES1302](#) [ACGRC307-HF](#) [ACEFC304-HF](#) [DZ-](#)
[1380](#) [85HFR60](#) [40HFR60](#) [70HF120](#) [85HFR80](#) [SCF7500](#) [SM100](#) [ACGRA4001-HF](#) [SKN70/08](#) [NTE5819](#) [NTE5827](#) [NTE5828](#) [NTE5911](#)
[NTE5915](#) [NTE6104](#) [NTE6163](#) [NTE6164](#) [NTE6165](#) [NTE6364](#) [TSD3G](#) [SET130312](#) [NRVUS110VT3G](#) [UES1106](#) [UES1306](#)
[NRVUS240VT3G](#) [D5FE60-5063](#) [R4000GPS-TP](#) [D4015L56TP](#) [UES1306HR2](#) [FX20K120](#) [D20XB60-7101](#)