

MURF1010CTR – MURF1060CTR

10 Amps Super Fast Recovery



MURF1010CTR – MURF1060CTR

Features:

- High surge capacity
- Low Forward Voltage Drop.
- High Current Capability.
- Super Fast Switching Speed For High Efficiency



TO-220F

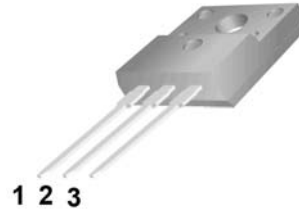

1.Cathode 2.Anode 3. Cathode

Absolute Maximum Ratings (Ta=25°C unless otherwise noted)

Parameter	Symbol	MURF 1010 CTR	MURF 1015 CTR	MURF 1020 CTR	MURF 1040 CTR	MURF 1060 CTR	Unit	
Peak Repetitive Reverse Voltage	V_{RRM}	100	150	200	400	600	V	
Working Peak Reverse Voltage	V_{RWM}	70	105	140	280	420	V	
DC Blocking Voltage	$V_{R(DC)}$	100	150	200	400	600	V	
Average Rectified Forward Current	$I_{F(AV)}$	Per Leg					5	A
		Total Device					10	
Peak Rectified Forward Current	I_{FM}	10					A	
Nonrepetitive Peak Surge Current(Surge applied at rated load conditions half wave, single phase, 60 Hz)	I_{FSM}	150					A	
Operating Junction Temperature and Storage Temperature	T_J, T_{stg}	-55 to +150					°C	
Maximum Thermal Resistance, Junction-to-Case(Per Leg)	$R_{\theta JC}$	2.0					°C/W	

ELECTRICAL CHARACTERISTICS (Per Diode Leg)

Parameter	Symbol	MURF 1010 CTR	MURF 1015 CTR	MURF 1020 CTR	MURF 1040 CTR	MURF 1060 CTR	Unit
Forward Voltage (Note 1) ($I_F = 5A, T_C = 25^\circ C$)	V_F	0.975			1.3	1.70	V
Maximum Instantaneous Reverse Current (Note 1) (Rated DC Voltage, $T_C = 25^\circ C$) (Rated DC Voltage, $T_C = 125^\circ C$)	I_R	10			500		μA
Maximum Reverse Recovery Time ($I_F = 0.5 A, I_R = 1.0 A, I_{REC} = 0.25 A$)	T_{RR}	35					ns

Note 1.Pulse Test: Pulse Width = 300 μ s, Duty Cycle $\leq 2.0\%$

Typical Characteristics

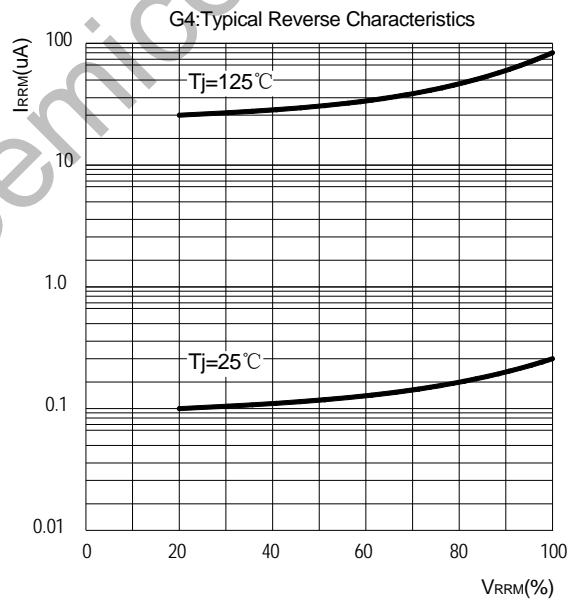
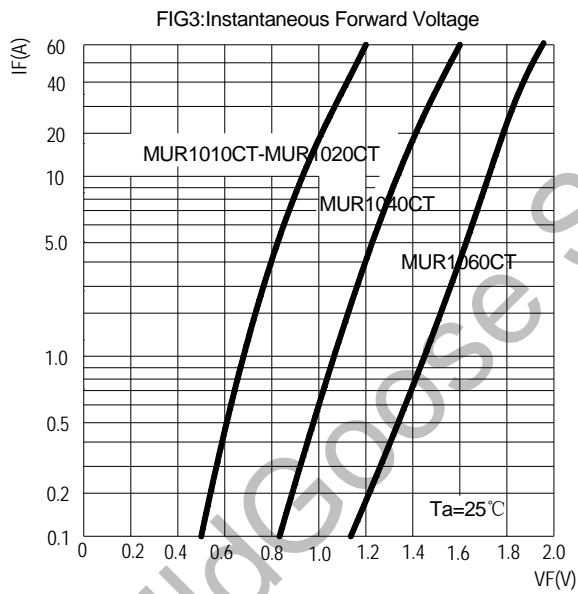
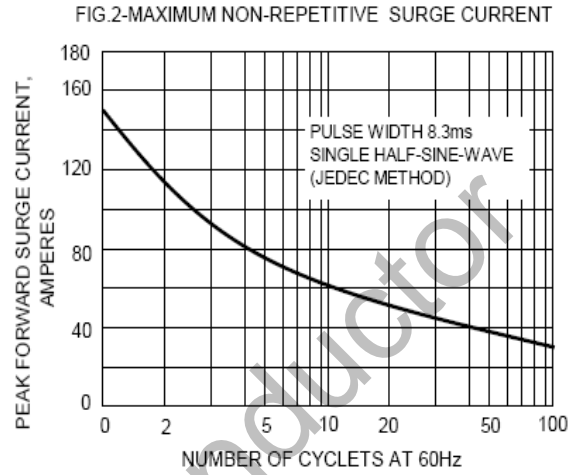
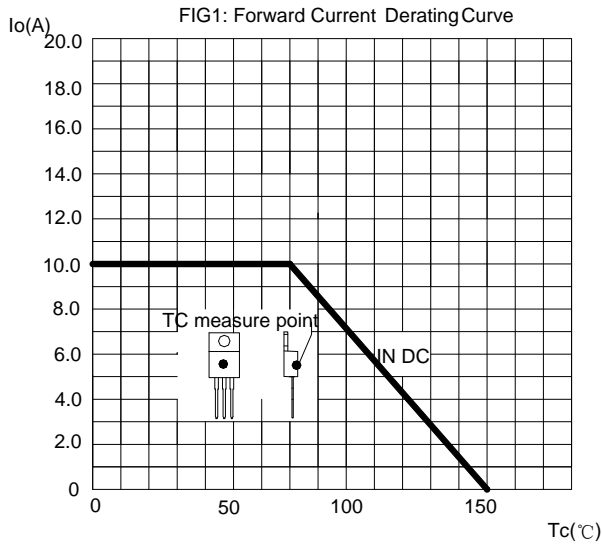
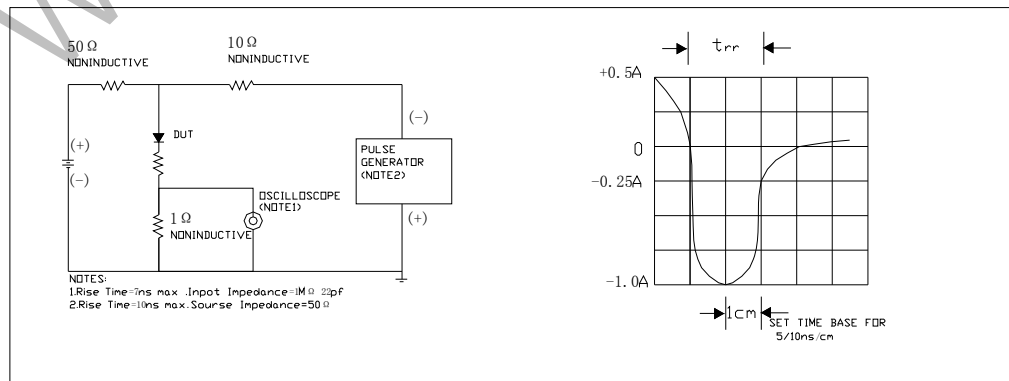
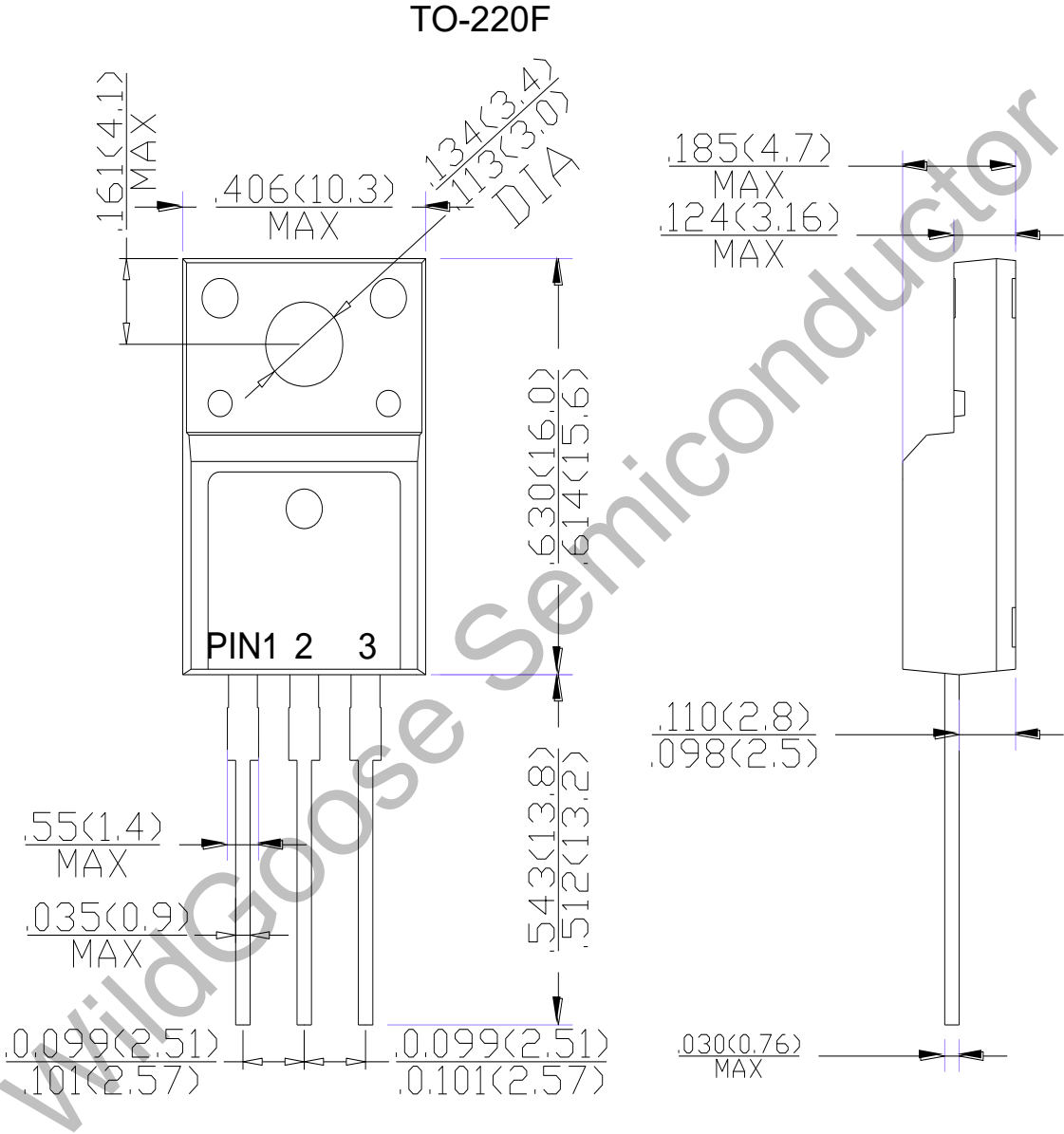

Diagram of circuit and Testing wave form of reverse recovery time



Package Dimension



Dimensions in inches and (millimeters)

X-ON Electronics

Largest Supplier of Electrical and Electronic Components

Click to view similar products for [Rectifiers](#) category:

Click to view products by [Wild Goose](#) manufacturer:

Other Similar products are found below :

[70HFR40](#) [FR105 R0](#) [RL252-TP](#) [1N5397](#) [1N4005-TR](#) [1N4007-BP](#) [UFS120Je3/TR13](#) [20ETS12S](#) [RRE02VS6SGTR](#) [MS306](#) [A1N5404G-G](#)
[CRF02\(T5L,TEMQ\)](#) [ACGRB207-HF](#) [CLH07\(TE16L,Q\)](#) [CLH03\(TE16L,Q\)](#) [1N5395-TP](#) [UES1302](#) [ACGRC307-HF](#) [ACEFC304-HF](#) [DZ-](#)
[1380](#) [85HFR60](#) [40HFR60](#) [70HF120](#) [85HFR80](#) [SCF7500](#) [SM100](#) [ACGRA4001-HF](#) [SKN70/08](#) [NTE5819](#) [NTE5827](#) [NTE5828](#) [NTE5911](#)
[NTE5915](#) [NTE6104](#) [NTE6163](#) [NTE6164](#) [NTE6165](#) [NTE6364](#) [TSD3G](#) [SET130312](#) [NRVUS110VT3G](#) [UES1106](#) [UES1306](#)
[NRVUS240VT3G](#) [D5FE60-5063](#) [R4000GPS-TP](#) [D4015L56TP](#) [UES1306HR2](#) [FX20K120](#) [D20XB60-7101](#)