





1-Line Bidirectional ESD Protection Diode

SOD323

Schematic & Pin configuration

Simplified outline	Graphic symbol
	

General description

These surge protection diodes are designed for applications requiring transient overvoltage protection capability. They are intended for use in voltage and ESD sensitive equipment such as computers, printers, business machines, communication systems, medical equipment and other applications. These devices are ideal for situations where board space is at a premium.

Features and benefits

- Bidirectional ESD protection of one line
- Reverse stand-off voltage: 3.3V Max
- Femtofarad capacitance: $C_j = 30\text{pF}$ (Typ)
- Complies with following standards: IEC 61000-4-2 (ESD) immunity test
 Air discharge: $\pm 30\text{KV}$, Contact discharge: $\pm 30\text{KV}$
 --IEC61000-4-5 (Lightning) 20A(8/20 μS)
- RoHS Compliant

Application information

- Cell Phone Handsets and Accessories
- Microprocessor based equipment
- Personal Digital Assistants (PDA's)
- Notebooks, Desktops, and Servers

Ordering information

Device	Package	Packaging	Reel Size
SD03CS	SOD323	3000/Tape & Reel	7 Inch

Maximum Ratings (Top=25 °C,unless otherwise specified)

Parameter	Symbol	Value	Unit
Peak Pulse Power (tp=8/20 μ s)	PpPM	160	W
Peak Pulse Current (tp=8/20 μ s)	IppM	20	A
ESD voltage IEC 61000-4-2 (air discharge)	VESD	30	kV
ESD voltage IEC 61000-4-2 (contact discharge)	VESD	30	kV
Maximum lead temperature for soldering during 10s	Tt	260	°C
Storage Temperature Range	Tstg	-55 to +150	°C
Operating Temperature Range	Top	-40 to +125	°C

Electrical Characteristics (Top=25 °C,unless otherwise specified)

Parameter	Symbo	Min	Typ	Max	Unit	Condition
Reverse Working Voltage	VRWN			3.3	V	
Breakdown Voltage	VBR	3.6	4.5	5.5	V	I _r =1mA
Leakage Current I _{Leak}	I _r			0.2	μA	V _{RWM} =3.3V
Clamping Voltage	V _c		5.5	6.5	V	I _{pp} =1A, T _p =8/20 μ s
Clamping Voltage	V _c		7.0	8.0	V	I _{pp} =20A, T _p =8/20 μ s
Dynamic Resistance	R _{pYN}		0.1		Ω	TLP=0.2/100ns
Junction Capacitance	C _J		30.0	40.0	pF	V _r =0V, f=1MHz

Note:TLP Setting:tp=100ns,tr=0.2ns,ITLP and VTLP sample window:t1=70ns to t2=90ns.

Portion Electronics Parameter

Symbol	Parameter
I _{pp}	Maximum Reverse Peak Pulse Current
V _c	Clamping Voltage @I _{pp}
V _{rwm}	Working Peak Reverse Voltage
I _g	Maximum Reverse Leakage Current @V _{rwm}
I _r	Test Current
V _{BR}	VBR Breakdown Voltage @I _r

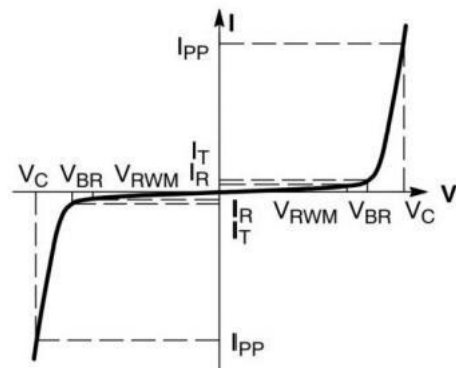

Typical Performance Characteristics (TA=25°C unless otherwise Specified)

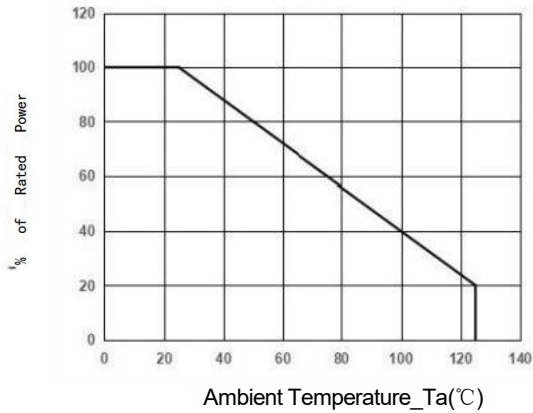

Power Derating Curve

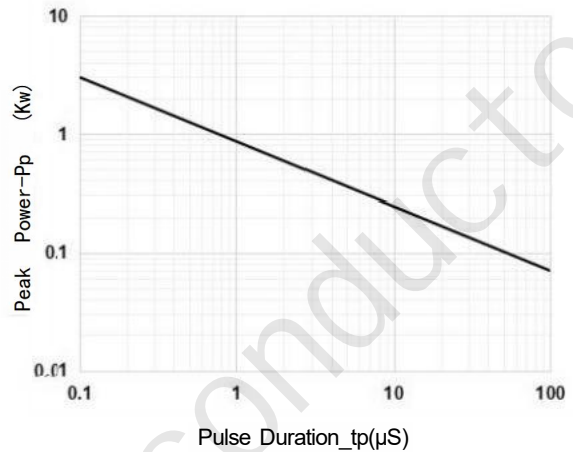

Peak Pulse Power vs.Pulse Time

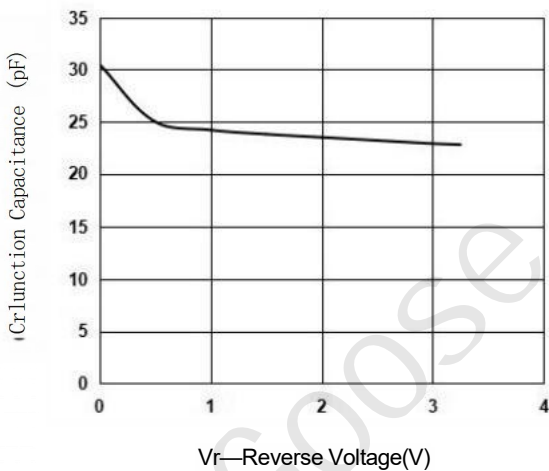

Junction Capacitance vs.Reverse Voltage

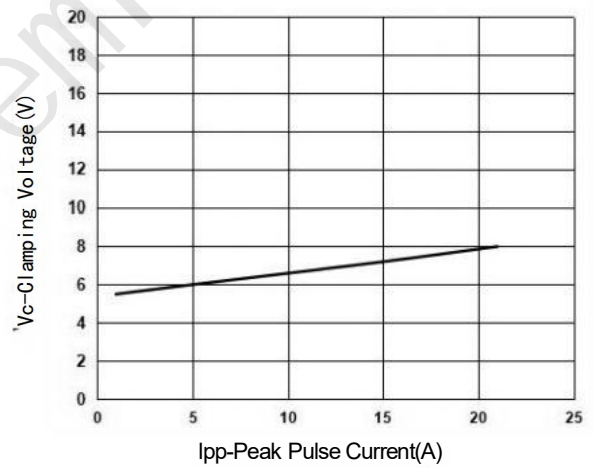

Clamping Voltage vs.Peak Pulse Current

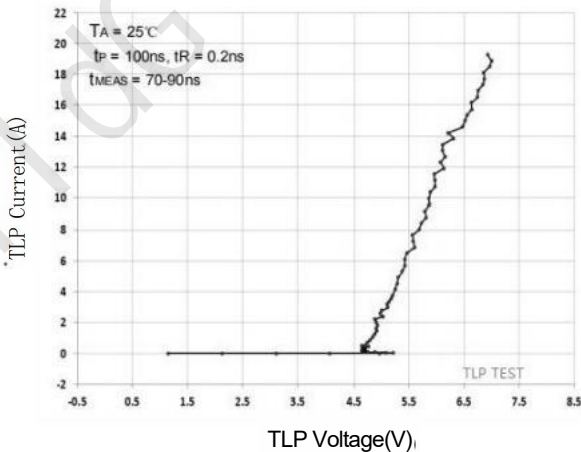

TLP Measurement Curve

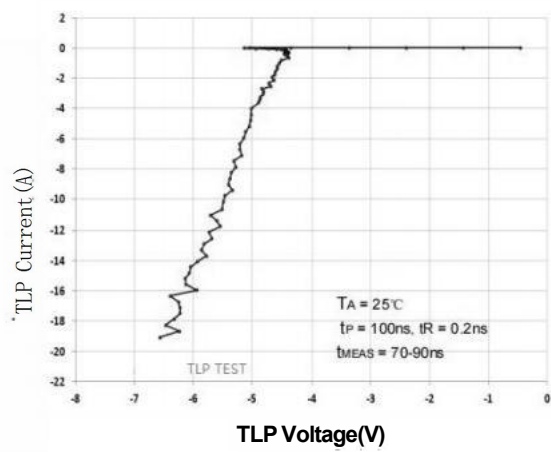

TLP Measurement Curve

Package Outline Dimensions

SOD323

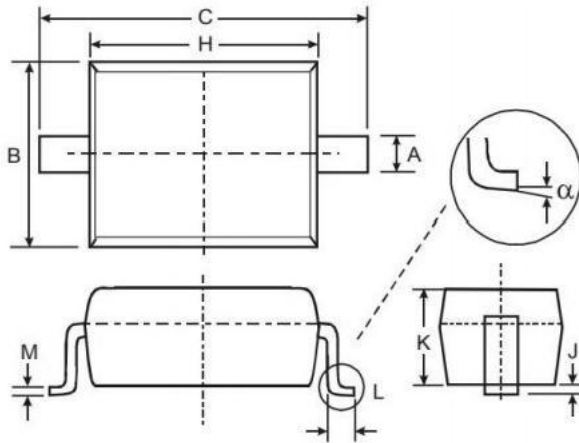

SYMBOL	MILLIMETERS	
	MIN	MAX
A	0.25	0.35
B	1.20	1.40
C	2.40	2.70
H	1.60	1.80
	0.01	0.15
K	0.80	1.00
L	0.20	0.40
M	0.08	0.15
a	0°	8°

X-ON Electronics

Largest Supplier of Electrical and Electronic Components

Click to view similar products for [ESD Suppressors / TVS Diodes](#) category:

Click to view products by [Wild Goose](#) manufacturer:

Other Similar products are found below :

[60KS200C](#) [D18V0L1B2LP-7B](#) [D5V0F4U5P5-7](#) [NTE4902](#) [P4KE27CA](#) [P6KE11CA](#) [P6KE8.2A](#) [SA60CA](#) [SA64CA](#) [SMBJ12CATR](#)
[SMBJ33CATR](#) [SMBJ6.5A](#) [SMBJ8.0A](#) [ESD101-B1-02ELS E6327](#) [ESD112-B1-02EL E6327](#) [ESD7451N2T5G](#) [19180-510](#) [CPDT-5V0USP-](#)
[HF](#) [3.0SMCJ33CA-F](#) [3.0SMCJ36A-F](#) [HSPC16701B02TP](#) [JANTX1N6126A](#) [D3V3Q1B2DLP3-7](#) [D55V0M1B2WS-7](#) [SCM1293A-04SO](#)
[ESD200-B1-CSP0201 E6327](#) [SM12-7](#) [CEN955 W/DATA](#) [VESD12A1A-HD1-GS08](#) [CPDQC5V0-HF](#) [D1213A-01LP4-7B](#) [ESD101-B1-02EL](#)
[E6327](#) [AOZ8808DI-03](#) [5KP15A](#) [5KP48A](#) [5KP90A](#) [ESD3V3D7-TP](#) [15KPA36A-LF](#) [P4KE56CA](#) [P4KE68A](#) [P4KE91CATR](#) [P6KE120A](#)
[P6KE13CA](#) [P6KE43CA](#) [P6KE6.8CA](#) [P6KE8.2](#) [P6SMBJ20CA](#) [JANTX1N6072A](#) [SR2835ESKG](#) [SA90CA](#)