

WGA40N50SE

500V N-Channel MOSFET

Features:

- Low Intrinsic Capacitances.
- Excellent Switching Characteristics.
- Extended Safe Operating Area.
- Unrivalled Gate Charge :Qg=130nC (Typ.).
- VDSS=500V, ID=40A
- R_{DS(on)} : 85mΩ (Tye) @V_G=10V
- 100% Avalanche Tested

TO-247 

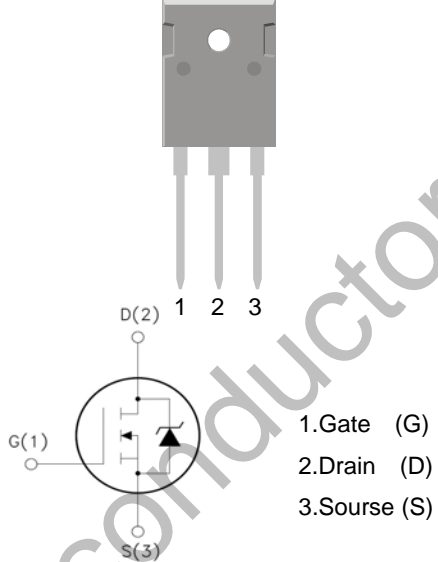

1.Gate (G)
2.Drain (D)
3.Source (S)

Absolute Maximum Ratings (* Drain current limited by junction temperature)

Symbol	Parameter	WGA40N50SE	Unit
V _{DSS}	Drain-to-Source Voltage	500	V
V _{GSS}	Gate-to-Source Voltage	±30	
I _D	Continuous Drain Current	40	A
	Continuous Drain Current @ T _C =100°C	30	
I _{DM}	Pulsed Drain Current at V _{GS} =10V ^[2,4]	180	
E _{AS}	Single Pulse Avalanche Energy	5000	mJ
dv/dt	Peak Diode Recovery dv/dt ^[3]	5.0	V/ns
P _D	Power Dissipation	540	W
	Derating Factor above 25°C	4.32	W/°C
T _L T _{PAK}	Maximum Temperature for Soldering Leads at 0.063in (1.6mm) from Case for 10 seconds, Package Body for 10 seconds	300 260	°C
T _J & T _{STG}	Operating and Storage Temperature Range	-55 to 150	

Caution: Stresses greater than those listed in the "Absolute Maximum Ratings" may cause permanent damage to the device.

Thermal Characteristics

Symbol	Parameter	WGA40N50SE	Unit
R _{θJC}	Thermal Resistance, Junction-to-Case	0.23	°C/W
R _{θJA}	Thermal Resistance, Junction-to-Ambient	50	

Electrical Characteristics ($T_C = 25\text{ }^\circ\text{C}$ unless otherwise noted)

Symbol	Parameter	Test Conditions	Min	Typ	Max	Units
Off Characteristics						
BV_{DSS}	Drain-Source Breakdown Voltage	$V_{GS} = 0V, I_D = 250\mu A$	500	-	-	V
$\Delta BV_{DSS} / \Delta T_J$	Breakdown Voltage Temperature coefficient	$I_D = 250\mu A$, referenced to $25\text{ }^\circ\text{C}$	-	0.3	-	V/ $^\circ\text{C}$
I_{DSS}	Drain-Source Leakage Current	$V_{DS} = 500V, V_{GS} = 0V$	-	-	1	μA
		$V_{DS} = 400V, T_C = 125\text{ }^\circ\text{C}$	-	-	10	μA
I_{GSS}	Gate-Source Leakage, Forward	$V_{GS} = 30V, V_{DS} = 0V$	-	-	100	nA
	Gate-source Leakage, Reverse	$V_{GS} = -30V, V_{DS} = 0V$	-	-	-100	nA
On Characteristics						
$V_{GS(th)}$	Gate Threshold Voltage	$V_{DS} = V_{GS}, I_D = 250\mu A$	2.0	-	4.0	V
$R_{DS(ON)}$	Static Drain-Source On-state Resistance	$V_{GS} = 10V, I_D = 20A$	-	85	100	m Ω
Dynamic Characteristics						
C_{iss}	Input Capacitance	$V_{GS} = 0V, V_{DS} = 25V, f = 1MHz$	-	8700	-	pF
C_{oss}	Output Capacitance		-	6090	-	
C_{rss}	Reverse Transfer Capacitance		-	870	-	
Dynamic Characteristics						
$t_{d(on)}$	Turn-on Delay Time	$V_{DD} = 250V, I_D = 20.0A, R_G = 25\Omega$ (Note 4, 5)	-	25	-	ns
t_r	Rise Time		-	39	-	
$t_{d(off)}$	Turn-off Delay Time		-	100	-	
t_f	Fall Time		-	36	-	
Q_g	Total Gate Charge	$V_{DS} = 250V, V_{GS} = 10V, I_D = 40.0A$ (Note 4, 5)	-	138	-	nC
Q_{gs}	Gate-Source Charge		-	38	-	
Q_{gd}	Gate-Drain Charge(Miller Charge)		-	27	-	

Source-Drain Diode Ratings and Characteristics

Symbol	Parameter	Test Conditions	Min.	Typ.	Max.	Unit.
I_S	Continuous Source Current	Integral Reverse p-n Junction Diode in the MOSFET	-	-	40	A
I_{SM}	Pulsed Source Current		-	-	160	
V_{SD}	Diode Forward Voltage	$I_S = 40.0A, V_{GS} = 0V$	-	-	1.4	V
t_{rr}	Reverse Recovery Time	$I_S = 40A, V_{GS} = 0V, dI_F/dt = 100A/\mu s$	-	730	-	ns
Q_{rr}	Reverse Recovery Charge		-	3.0	-	μC

* NOTES

- [1] $T_J = +25\text{ }^\circ\text{C}$ to $+150\text{ }^\circ\text{C}$.
 [2] Silicon limited current only.
 [3] Package limited current.
 [4] Repetitive rating; pulse width limited by maximum junction temperature.
 [5] Pulse width $\leq 380\mu s$; duty cycle $\leq 2\%$.

Typical Characteristics ($T_C = 25^\circ\text{C}$ unless otherwise noted)

Figure 1. Maximum Transient Thermal Impedance

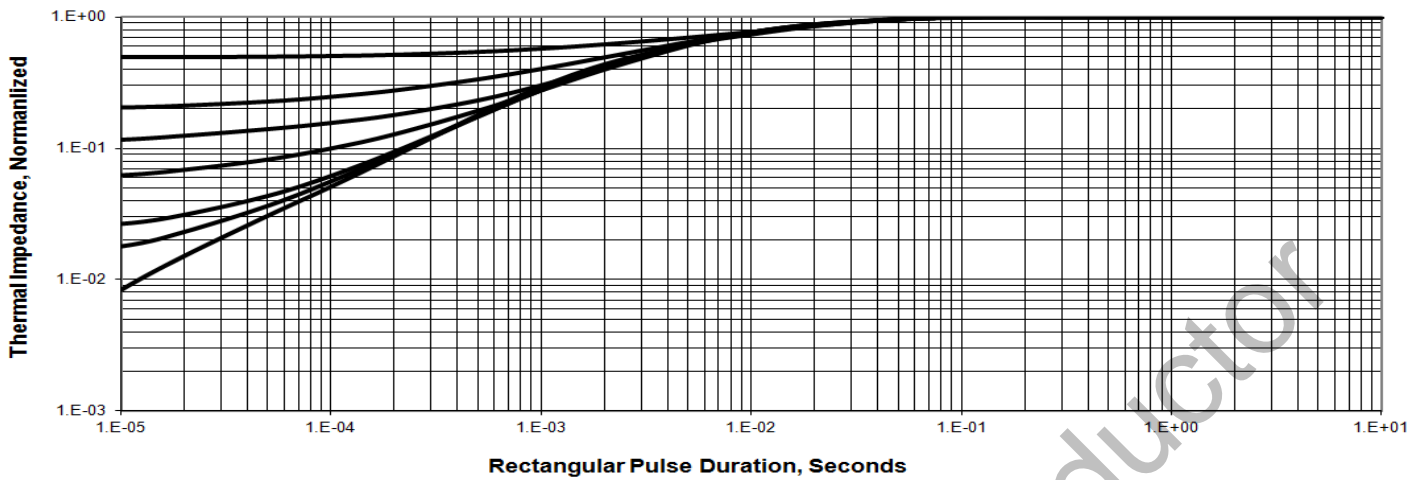

Figure 2 . Max. Power Dissipation vs Case Temperature

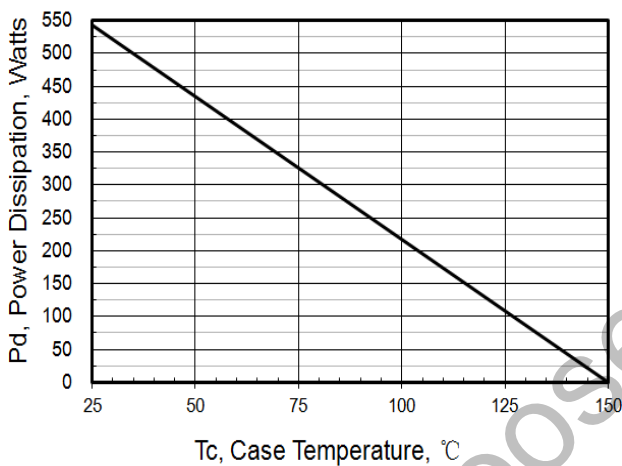

Figure 3 .Maximum Continuous Drain Current vs Tc

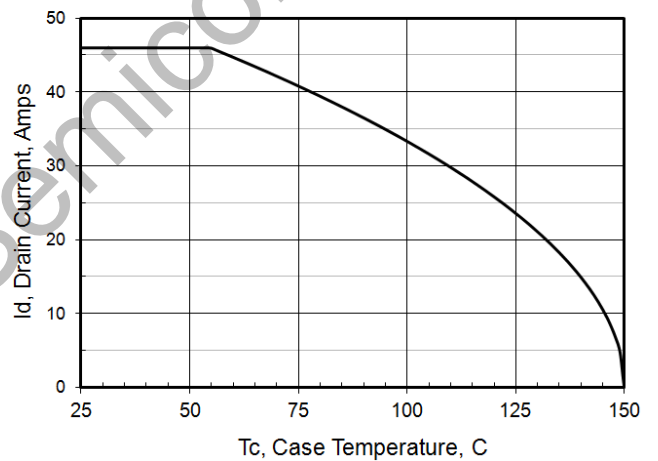

Figure 4. Typical Output Characteristics

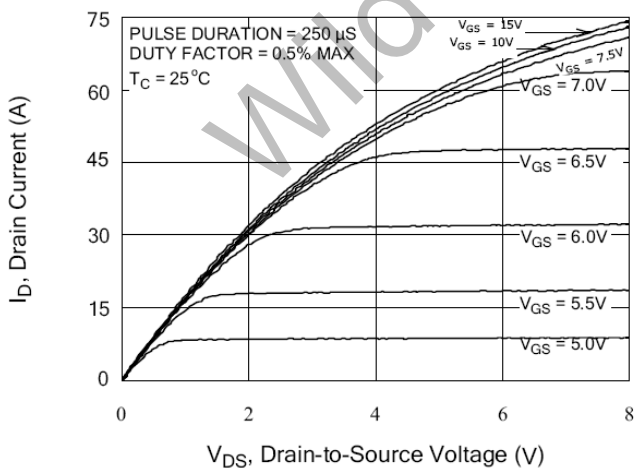
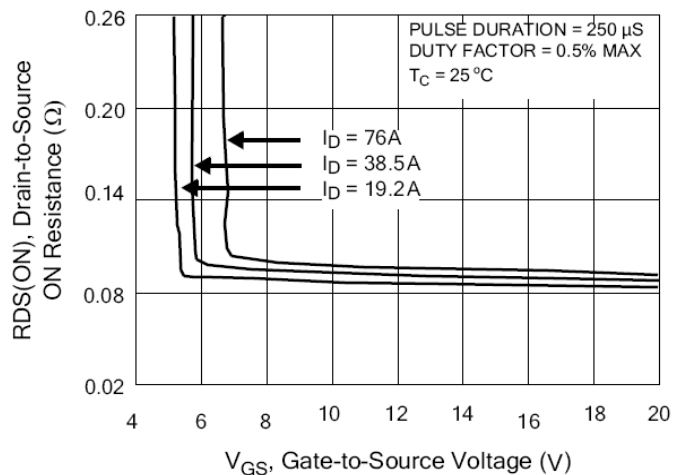

Figure5. Typical Drain-to-Source ON Resistance vs Gate Voltage and Drain Current



Typical Characteristics (T_C = 25 °C unless otherwise noted)

Figure 6. Peak Current Capability

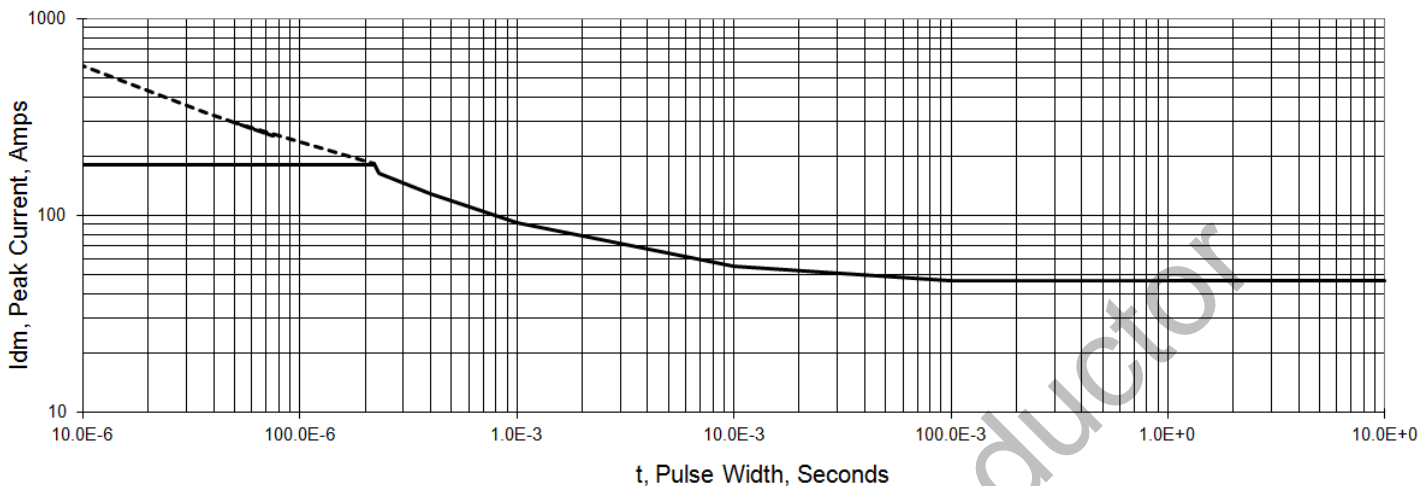

Figure 7. Typical Transfer Characteristics

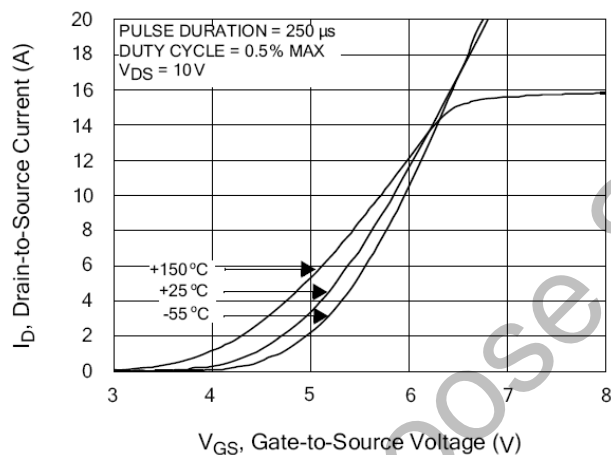

Figure 8. Unclamped Inductive Switching Capability

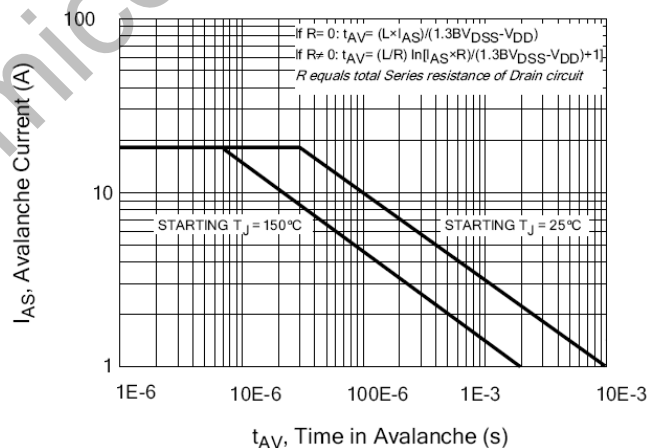

Figure 9. Typical Drain-to-Source ON Resistance vs Drain Current

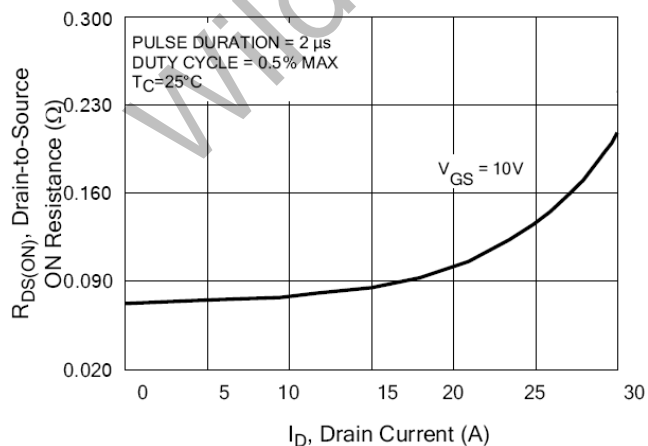
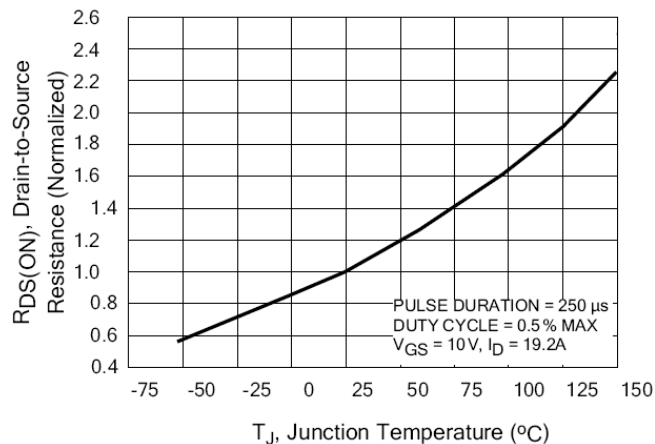

Figure 10. Typical Drain-to-Source ON Resistance vs Junction Temperature



Typical Characteristics ($T_C = 25\text{ }^\circ\text{C}$ unless otherwise noted)

Figure 11. Typical Breakdown Voltage vs Junction Temperature

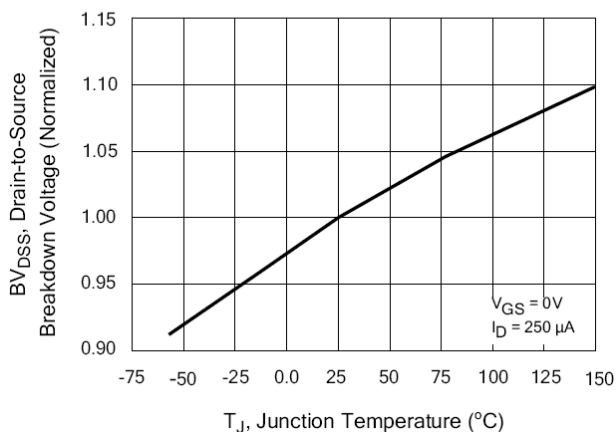

Figure 12. Typical Threshold Voltage vs Junction Temperature

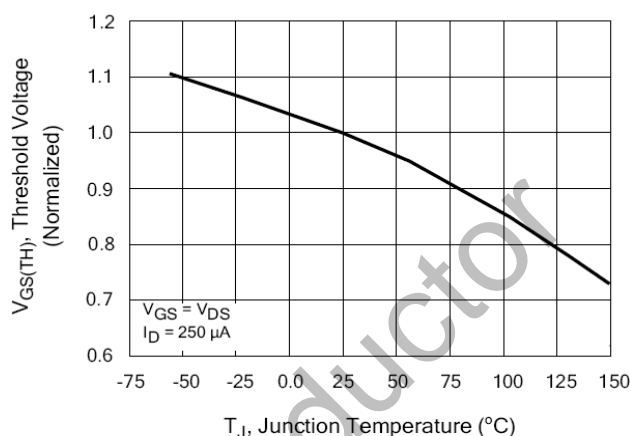

Figure 13. Maximum Forward Bias Safe Operating Area

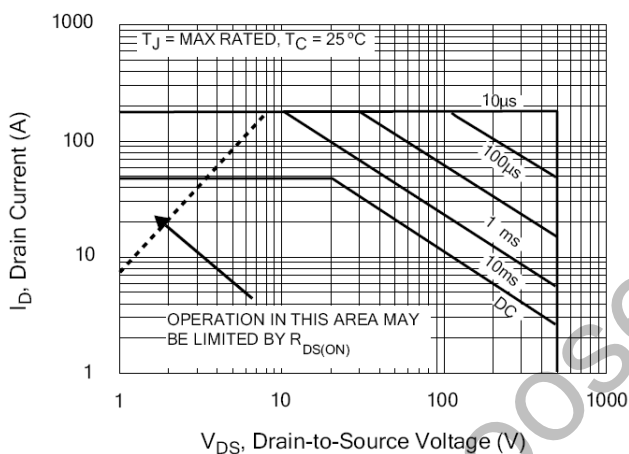

Figure 14. Typical Capacitance vs Drain-to-Source Voltage

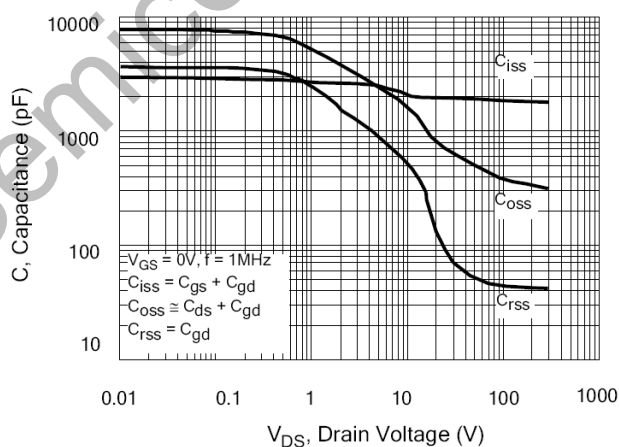

Figure 15. Typical Gate Charge vs Gate-to-Source Voltage

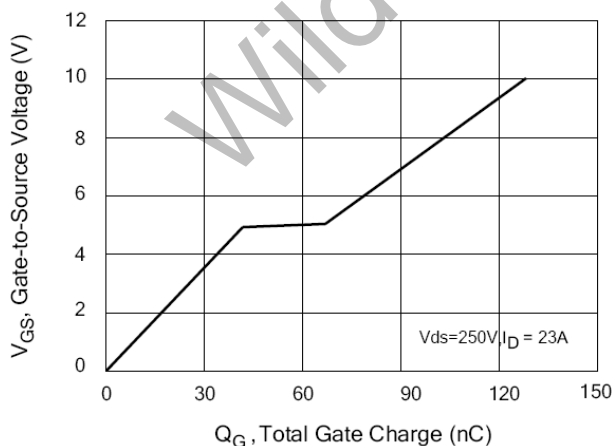
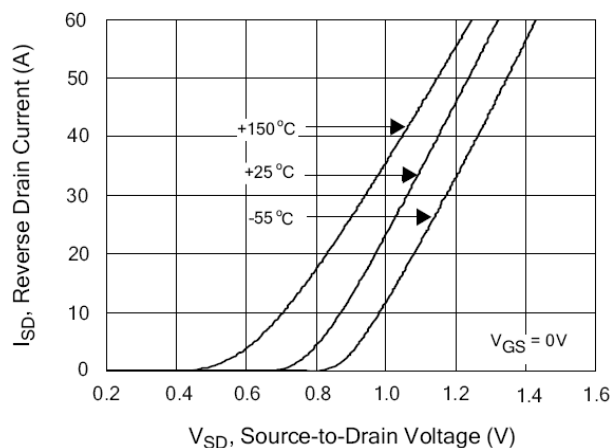

Figure 16. Typical Body Diode Transfer Characteristics



Test circuit

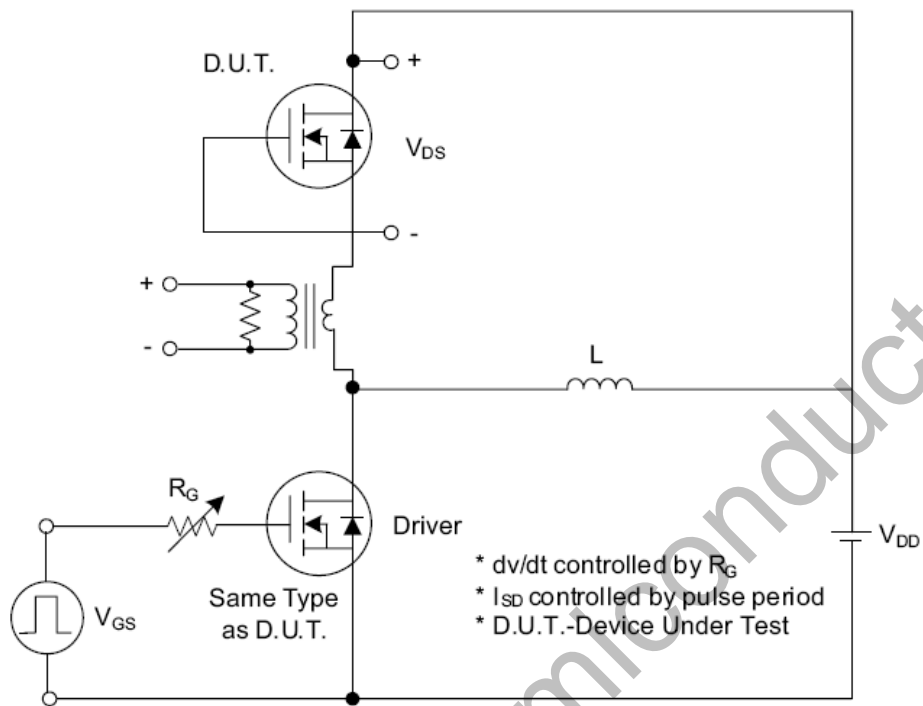

Fig. 1.1 Peak Diode Recovery dv/dt Test Circuit

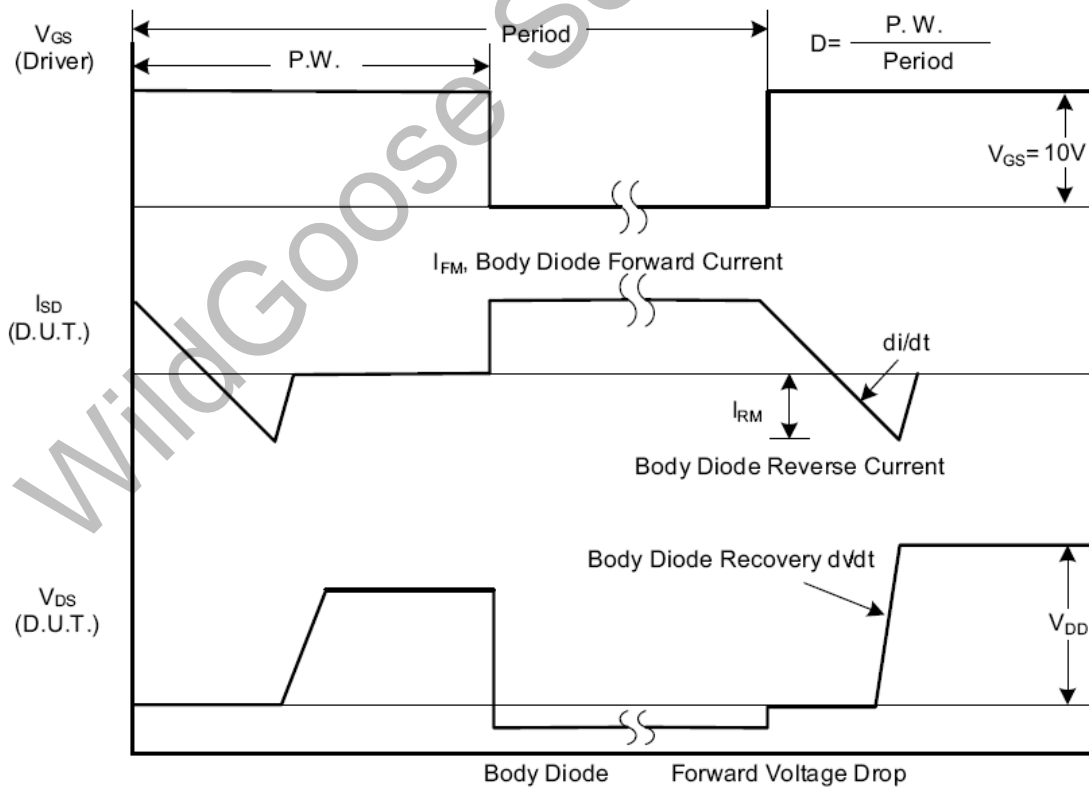

Fig. 1.2 Peak Diode Recovery dv/dt Waveforms

Test circuit

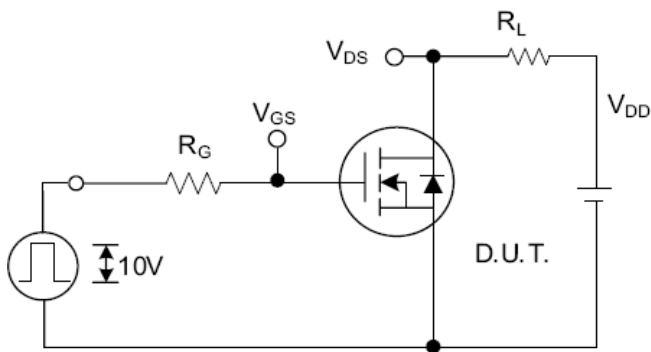

Fig. 2.1 Switching Test Circuit

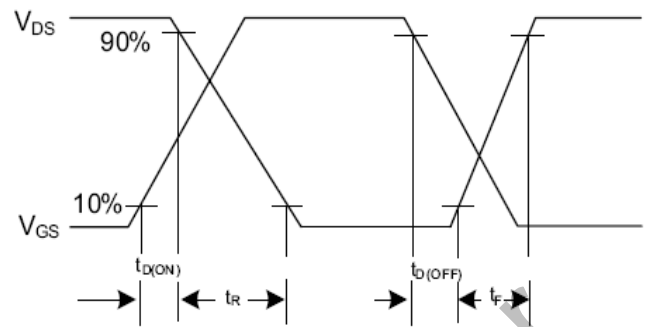

Fig. 2.2 Switching Waveforms

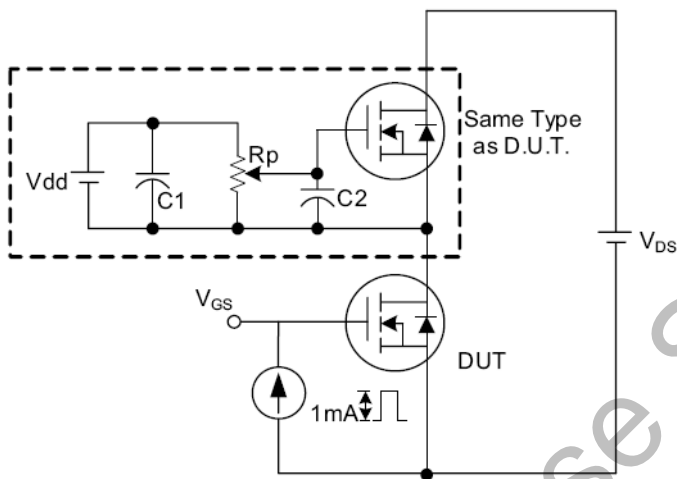

Fig. 3. 1 Gate Charge Test Circuit

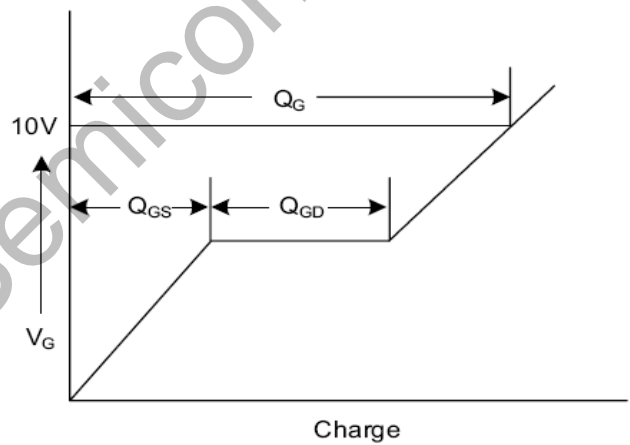

Fig. 3. 2 Gate Charge Waveform

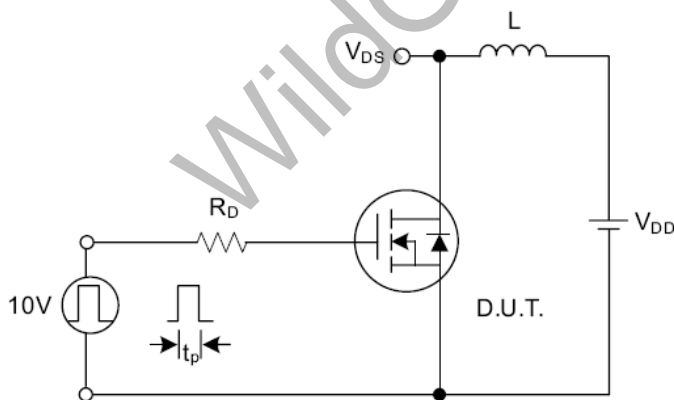

Fig. 4.1 Unclamped Inductive Switching Test Circuit

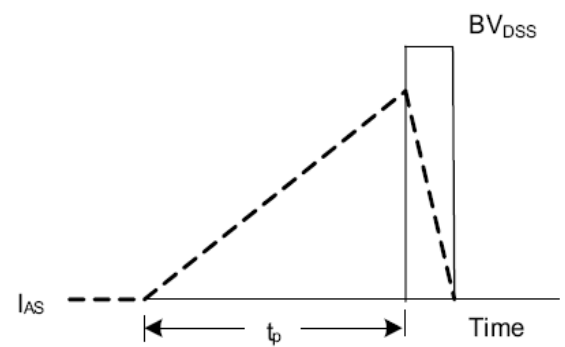
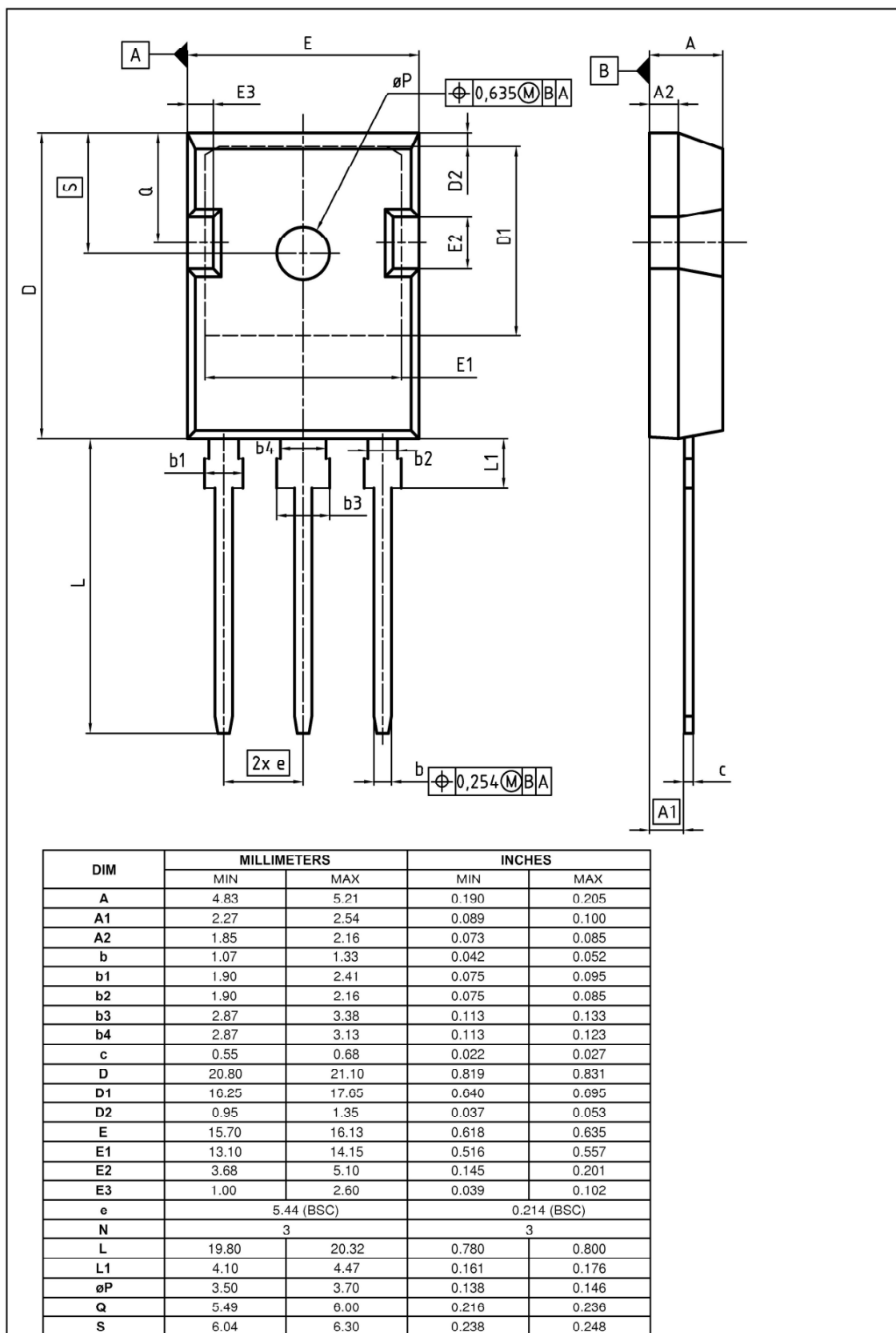

Fig. 4.2 Unclamped Inductive Switching Waveforms

Package Dimension**TO-247**

X-ON Electronics

Largest Supplier of Electrical and Electronic Components

Click to view similar products for [MOSFET](#) category:

Click to view products by [Wild Goose](#) manufacturer:

Other Similar products are found below :

[IRFD120](#) [JANTX2N5237](#) [BUK455-60A/B](#) [MIC4420CM-TR](#) [VN1206L](#) [NDP4060](#) [SI4482DY](#) [IPS70R2K0CEAKMA1](#) [SQD23N06-31L-GE3](#)
[TK16J60W,S1VQ\(O](#) [2SK2614\(TE16L1,Q\)](#) [DMN1017UCP3-7](#) [DMN1053UCP4-7](#) [SQJ469EP-T1-GE3](#) [NTE2384](#) [DMC2700UDMQ-7](#)
[DMN2080UCB4-7](#) [DMN61D9UWQ-13](#) [US6M2GTR](#) [DMN31D5UDJ-7](#) [DMP22D4UFO-7B](#) [DMN1006UCA6-7](#) [DMN16M9UCA6-7](#)
[STF5N65M6](#) [IRF40H233XTMA1](#) [STU5N65M6](#) [DMN6022SSD-13](#) [DMN13M9UCA6-7](#) [DMTH10H4M6SPS-13](#) [DMN2990UFB-7B](#)
[IPB80P04P405ATMA2](#) [2N7002W-G](#) [MCAC30N06Y-TP](#) [MCQ7328-TP](#) [BXP7N65D](#) [BXP4N65F](#) [AOL1454G](#) [WMJ80N60C4](#) [BXP2N20L](#)
[BXP2N65D](#) [BXT1150N10J](#) [BXT1700P06M](#) [TSM60NB380CP ROG](#) [RQ7L055BGTCR](#) [DMNH15H110SK3-13](#) [SLF10N65ABV2](#)
[BSO203SP](#) [BSO211P](#) [IPA60R230P6](#) [IPA60R460CE](#)