

**ESD5305FB**

**4-Lines, Uni-directional, Low Capacitance  
Transient Voltage Suppressors**

<http://www.sh-willsemi.com>

**Descriptions**

The ESD5305FB is a low capacitance TVS (Transient Voltage Suppressor) array designed to protect high speed data interfaces. It has been specifically designed to protect sensitive electronic components which are connected to data and transmission lines from over-stress caused by ESD (Electrostatic Discharge).

The ESD5305FB incorporates four pairs of low capacitance steering diodes plus a TVS diode.

The ESD5305FB may be used to provide ESD protection up to  $\pm 30\text{kV}$  (contact discharge) according to IEC61000-4-2, and withstand peak pulse current up to 6A (8/20 $\mu\text{s}$ ) according to IEC61000-4-5.

The ESD5305FB is available in SOT23-6L package. Standard products are Pb-free and Halogen-free.

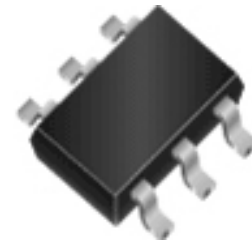

**SOT23-6L**

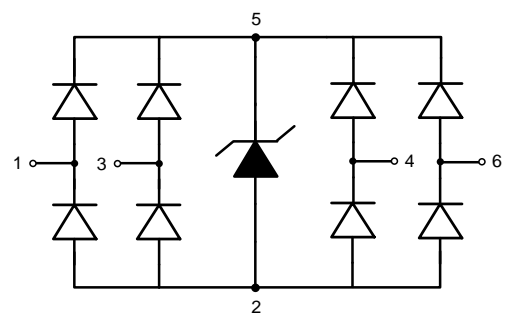

**Circuit diagram**

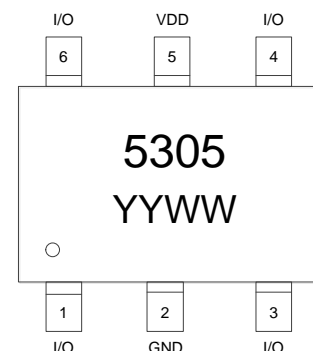

5305 = Device code  
YY = Year code  
WW = Week code

**Marking & Pin configuration (Top View)**

**Features**

- Reverse stand-off voltage: 5V max.
- Transient protection for each line according to IEC61000-4-2 (ESD):  $\pm 30\text{kV}$  (contact discharge)  
IEC61000-4-5 (surge): 6A (8/20 $\mu\text{s}$ )
- Low capacitance:  $C_{I/O-GND} = 0.65\text{pF}$  typ. (VDD = floated)  
 $C_{I/O-GND} = 0.35\text{pF}$  typ. (VDD = 5V)
- Ultra-low leakage current:  $I_R < 1\text{nA}$  typ.
- Low clamping voltage:  $V_{CL} = 12.8\text{V}$  @  $I_{PP} = 16\text{A}$  (TLP)
- Solid-state silicon technology

**Applications**

- USB 2.0
- HDMI 1.3
- SATA and eSATA
- DVI
- IEEE 1394
- PCI Express
- Portable Electronics
- Notebooks

**Order information**

Device	Package	Shipping
ESD5305FB-6/TR	SOT23-6L	3000/Tape&Reel

**Absolute maximum ratings**

Parameter	Symbol	Rating	Unit
Peak pulse power ( $t_p = 8/20\mu s$ )	$P_{pk}$	84	W
Peak pulse current ( $t_p = 8/20\mu s$ )	$I_{PP}$	6	A
ESD according to IEC61000-4-2 air discharge	$V_{ESD}$	$\pm 30$	kV
ESD according to IEC61000-4-2 contact discharge		$\pm 30$	
Junction temperature	$T_J$	125	$^{\circ}C$
Operation temperature	$T_{OP}$	-40 to 85	$^{\circ}C$
Storage temperature	$T_{STG}$	-55 to 150	$^{\circ}C$
Lead temperature	$T_L$	260	$^{\circ}C$

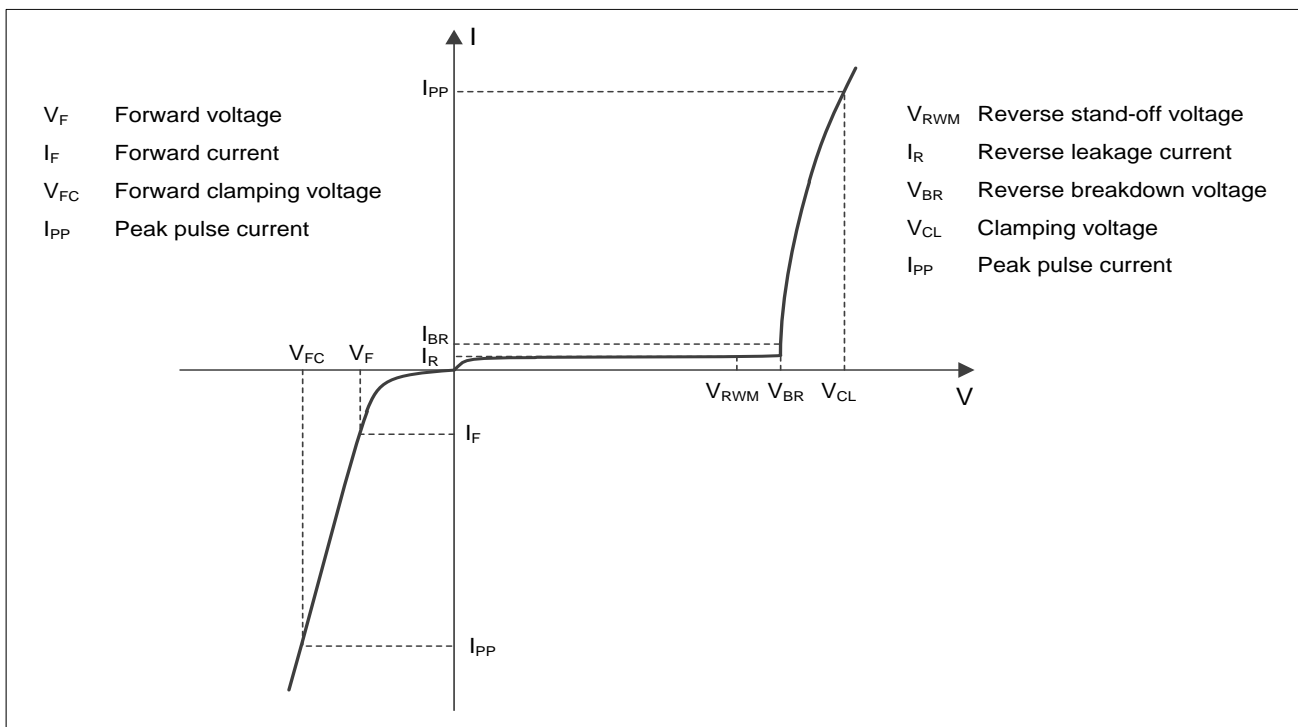
**Electrical characteristics ( $T_A = 25^{\circ}C$ , unless otherwise noted)**

**Definitions of electrical characteristics**

**Electrical characteristics (T<sub>A</sub> = 25°C, unless otherwise noted)**

Parameter	Symbol	Condition	Min.	Typ.	Max.	Unit
Reverse stand-off voltage	V <sub>RWM</sub>				5.0	V
Reverse leakage current	I <sub>R</sub>	V <sub>RWM</sub> = 5V		<1	50	nA
Reverse breakdown voltage	V <sub>BR</sub>	I <sub>BR</sub> = 1mA	7.0	8.0	9.0	V
Forward voltage	V <sub>F</sub>	I <sub>F</sub> = 10mA	0.6	0.9	1.2	V
Clamping voltage <sup>1)</sup>	V <sub>CL</sub>	I <sub>PP</sub> = 16A, t <sub>p</sub> = 100ns		12.8		V
Dynamic resistance <sup>1)</sup>	R <sub>DYN</sub>			0.24		Ω
Clamping voltage <sup>2)</sup>	V <sub>CL</sub>	I <sub>PP</sub> = 1A, t <sub>p</sub> = 8/20μs			10	V
		I <sub>PP</sub> = 6A, t <sub>p</sub> = 8/20μs			14	V
Junction capacitance	C <sub>I/O - GND</sub>	V <sub>R</sub> = 0V, f = 1MHz, VDD = floated, any I/O to GND		0.65	1.0	pF
		V <sub>R</sub> = 0V, f = 1MHz, VDD = 5V, any I/O to GND		0.35	0.50	pF
	C <sub>I/O - I/O</sub>	V <sub>R</sub> = 0V, f = 1MHz, any I/O to I/O		0.35	0.50	pF

**Notes:**

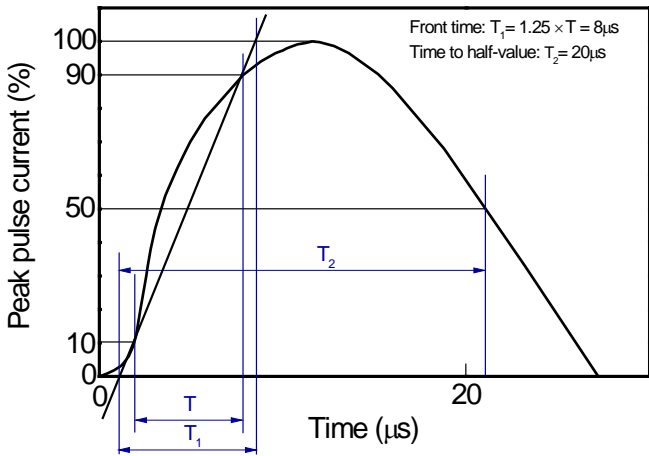
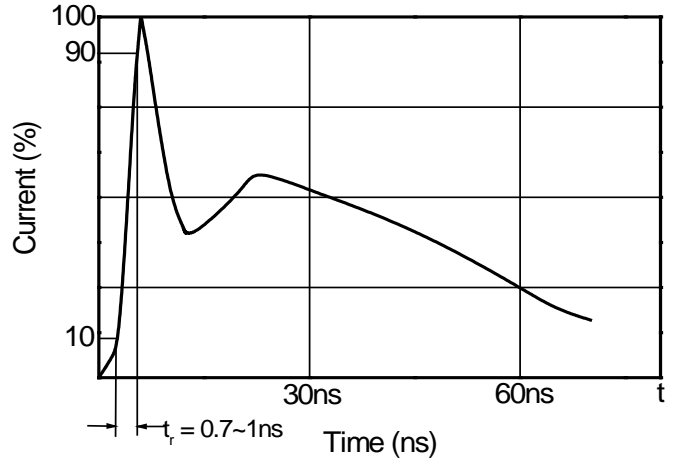
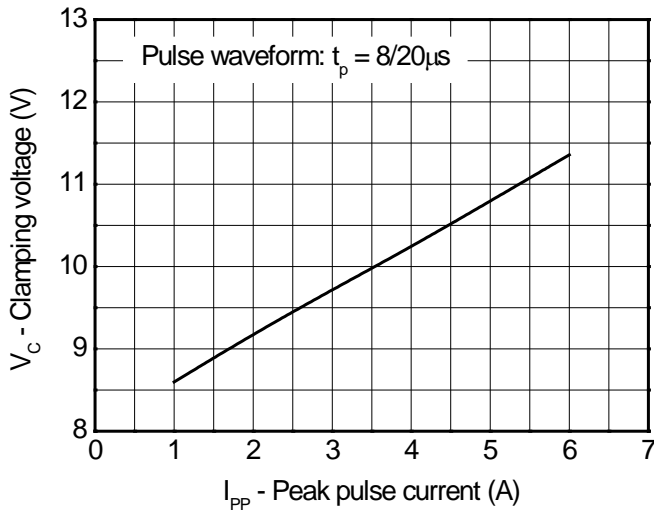
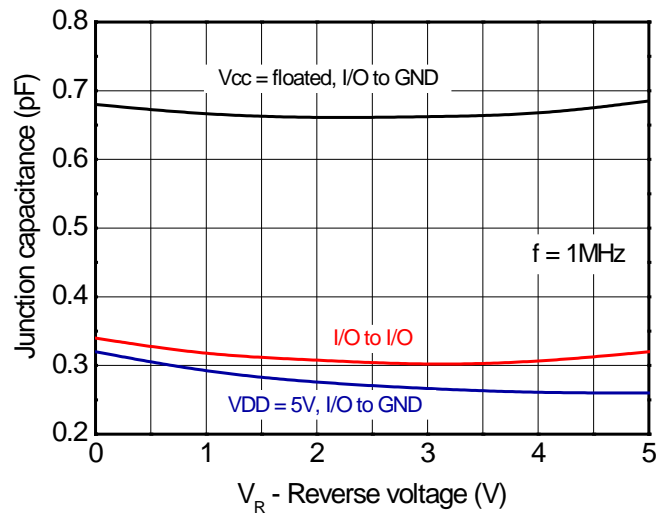
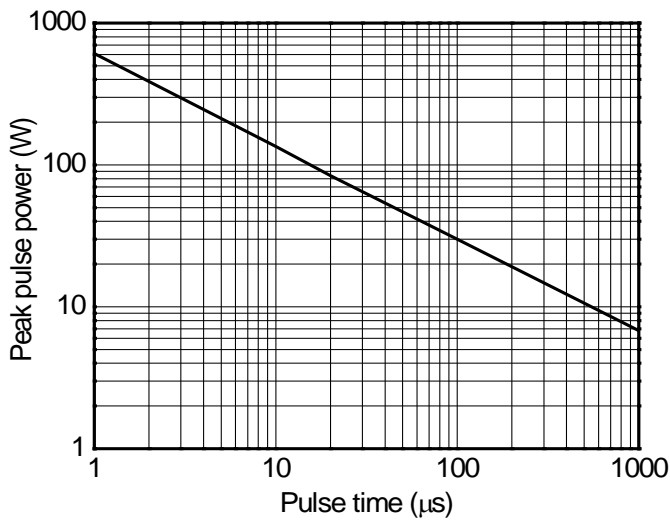
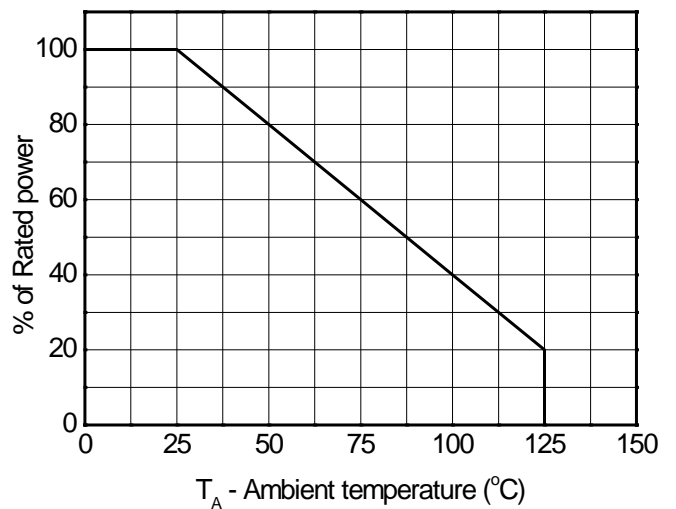
- 1) TLP parameter: Z<sub>0</sub> = 50Ω, t<sub>p</sub> = 100ns, t<sub>r</sub> = 2ns, averaging window from 60ns to 80ns. R<sub>DYN</sub> is calculated from 10A to 30A.
- 2) Non-repetitive current pulse, according to IEC61000-4-5.

**Typical characteristics ( $T_A = 25^\circ\text{C}$ , unless otherwise noted)**

**8/20 $\mu\text{s}$  waveform per IEC61000-4-5**

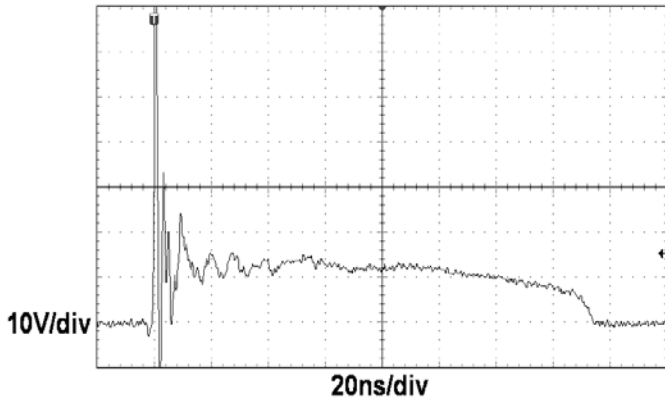
**Contact discharge current waveform per IEC61000-4-2**

**Clamping voltage vs. Peak pulse current**

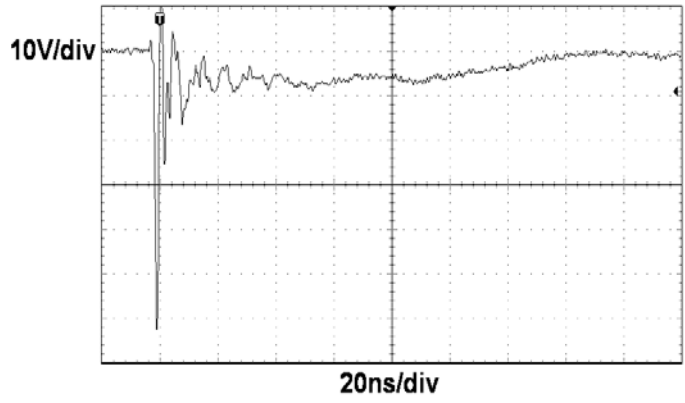
**Capacitance vs. Reverse voltage**

**Non-repetitive peak pulse power vs. Pulse time**

**Power derating vs. Ambient temperature**

Typical characteristics ( $T_A = 25^\circ\text{C}$ , unless otherwise noted)



**ESD clamping**  
 (+8kV contact discharge per IEC61000-4-2)



**ESD clamping**  
 (-8kV contact discharge per IEC61000-4-2)

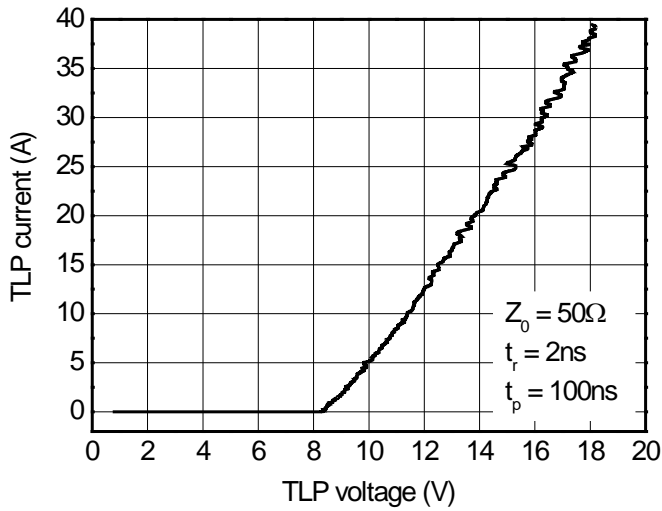

**TLP Measurement**

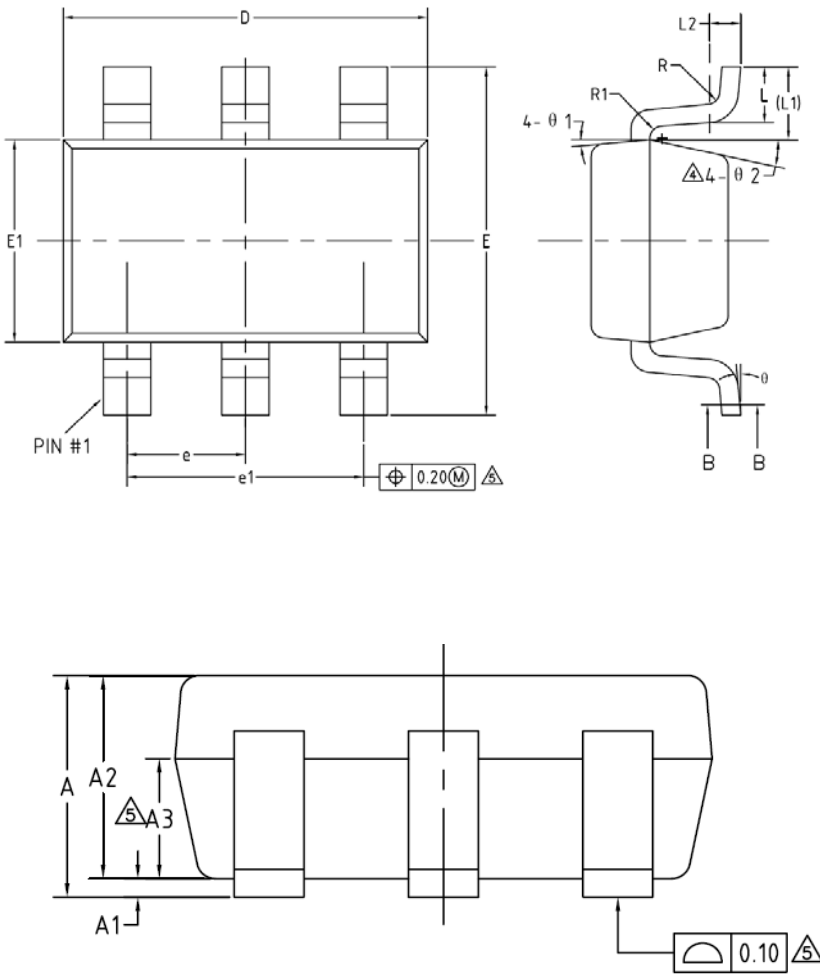
**Package outline dimensions**
**SOT23-6L**

Symbol	Dimensions In Millimeters		
	Min.	Typ.	Max.
A	--	--	1.250
A1	0.000	--	0.150
A2	1.000	1.100	1.200
A3	0.600	0.650	0.700
b	0.360	--	0.500
b1	0.360	0.380	0.450
c	0.140	--	0.200
c1	0.140	0.150	0.160
D	2.826	2.926	3.026
E	2.600	2.800	3.000
E1	1.526	1.626	1.726
e	0.900	0.950	1.000
e1	1.800	1.900	2.000
L	0.350	0.450	0.600
L1	0.590REF		
L2	0.250BSC		
R	0.100	--	--
R1	0.100	--	0.200
θ	0°	--	8°
θ1	3°	5°	7°
θ2	6°	--	14°

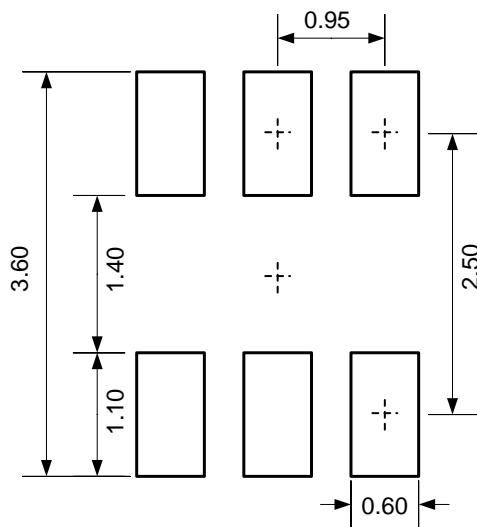
**Recommended land pattern (Unit: mm)**

**Notes:**

This recommended land pattern is for reference purposes only. Please consult your manufacturing group to ensure your PCB design guidelines are met.

## X-ON Electronics

Largest Supplier of Electrical and Electronic Components

*Click to view similar products for [ESD Suppressors / TVS Diodes](#) category:*

*Click to view products by [Will Semiconductor](#) manufacturer:*

Other Similar products are found below :

[60KS200C](#) [D18V0L1B2LP-7B](#) [D5V0F4U5P5-7](#) [NTE4902](#) [P4KE27CA](#) [P6KE11CA](#) [P6KE8.2A](#) [SA60CA](#) [SA64CA](#) [SMBJ12CATR](#)  
[SMBJ33CATR](#) [SMBJ6.5A](#) [SMBJ8.0A](#) [ESD101-B1-02ELS](#) [E6327](#) [ESD112-B1-02EL](#) [E6327](#) [ESD7451N2T5G](#) [19180-510](#) [CPDT-5V0USP-](#)  
[HF](#) [3.0SMCJ33CA-F](#) [3.0SMCJ36A-F](#) [HSPC16701B02TP](#) [JANTX1N6126A](#) [D3V3Q1B2DLP3-7](#) [D55V0M1B2WS-7](#) [SCM1293A-04SO](#)  
[ESD200-B1-CSP0201](#) [E6327](#) [SM12-7](#) [CEN955](#) [W/DATA](#) [VESD12A1A-HD1-GS08](#) [CPDQC5V0-HF](#) [D1213A-01LP4-7B](#) [ESD101-B1-02EL](#)  
[E6327](#) [AOZ8808DI-03](#) [5KP15A](#) [5KP48A](#) [5KP90A](#) [ESD3V3D7-TP](#) [15KPA36A-LF](#) [P4KE56CA](#) [P4KE68A](#) [P4KE91CATR](#) [P6KE120A](#)  
[P6KE13CA](#) [P6KE43CA](#) [P6KE6.8CA](#) [P6KE8.2](#) [P6SMBJ20CA](#) [JANTX1N6072A](#) [SR2835ESKG](#) [SA90CA](#)