

ESD5311Z
**1-Line, Bi-directional, Ultra-low Capacitance
Transient Voltage Suppressor**
<http://www.sh-willsemi.com>
Descriptions

The ESD5311Z is an ultra-low capacitance TVS (Transient Voltage Suppressor) designed to protect high speed data interfaces. It has been specifically designed to protect sensitive electronic components which are connected to data and transmission lines from over-stress caused by ESD (Electrostatic Discharge).

The ESD5311Z incorporates one pair of ultra-low capacitance steering diodes plus a TVS diode.

The ESD5311Z may be used to provide ESD protection up to $\pm 20\text{kV}$ (contact discharge) according to IEC61000-4-2, and withstand peak pulse current up to 4A (8/20 μs) according to IEC61000-4-5.

The ESD5311Z is available in DFN0603-2L package. Standard products are Pb-free and Halogen-free.

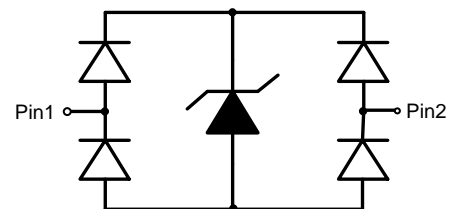
DFN0603-2L (Bottom View)

Pin configuration
Features

- Stand-off voltage: 5V Max.
- Transient protection for each line according to IEC61000-4-2 (ESD): $\pm 20\text{kV}$ (contact discharge)
IEC61000-4-4 (EFT): 40A (5/50ns)
IEC61000-4-5 (surge): 4 A (8/20 μs)
- Ultra-low capacitance: $C_J = 0.25\text{pF}$ typ.
- Ultra-low leakage current: $I_R < 1\text{nA}$ typ.
- Low clamping voltage: $V_{CL} = 21\text{V}$ typ. @ $I_{PP} = 16\text{A}$ (TLP)
- Small package

Applications

- USB 2.0 and USB 3.0
- HDMI 1.3 and HDMI 1.4
- SATA and eSATA
- DVI
- IEEE 1394
- PCI Express
- Portable Electronics
- Notebooks



D = Device code
* = Month code

Marking (Top View)
Order information

Device	Package	Shipping
ESD5311Z-2/TR	DFN0603-2L	10000/Tape&Reel

Absolute maximum ratings

Parameter	Symbol	Rating	Unit
Peak pulse power ($t_p = 8/20\mu\text{s}$)	P_{pk}	84	W
Peak pulse current ($t_p = 8/20\mu\text{s}$)	I_{PP}	4	A
ESD according to IEC61000-4-2 air discharge	V_{ESD}	± 20	kV
ESD according to IEC61000-4-2 contact discharge		± 20	
Junction temperature	T_J	125	$^{\circ}\text{C}$
Operating temperature	T_{OP}	-40~85	$^{\circ}\text{C}$
Lead temperature	T_L	260	$^{\circ}\text{C}$
Storage temperature	T_{STG}	-55~150	$^{\circ}\text{C}$

Electrical characteristics ($T_A=25^{\circ}\text{C}$, unless otherwise noted)

Parameter	Symbol	Condition	Min.	Typ.	Max.	Unit
Reverse maximum working voltage	V_{RWM}				5.0	V
Reverse leakage current	I_R	$V_{RWM} = 5\text{V}$		<1	100	nA
Reverse breakdown voltage	V_{BR}	$I_T = 1\text{mA}$	7.5	9.0	10.0	V
Clamping voltage ¹⁾	V_{CL}	$I_{PP} = 16\text{A}$, $t_p = 100\text{ns}$		21		V
Dynamic resistance ¹⁾	R_{DYN}			0.7		Ω
Clamping voltage ²⁾	V_{CL}	$V_{ESD} = 8\text{kV}$		21		V
Clamping voltage ³⁾	V_{CL}	$I_{PP} = 1\text{A}$, $t_p = 8/20\mu\text{s}$			14	V
		$I_{PP} = 4\text{A}$, $t_p = 8/20\mu\text{s}$			21	V
Junction capacitance	C_J	$V_R = 0\text{V}$, $f = 1\text{MHz}$		0.25	0.4	pF

Notes:

- 1) TLP parameter: $Z_0 = 50\Omega$, $t_p = 100\text{ns}$, $t_r = 2\text{ns}$, averaging window from 60ns to 80ns. R_{DYN} is calculated from 4A to 16A.
- 2) Contact discharge mode, according to IEC61000-4-2.
- 3) Non-repetitive current pulse, according to IEC61000-4-5.

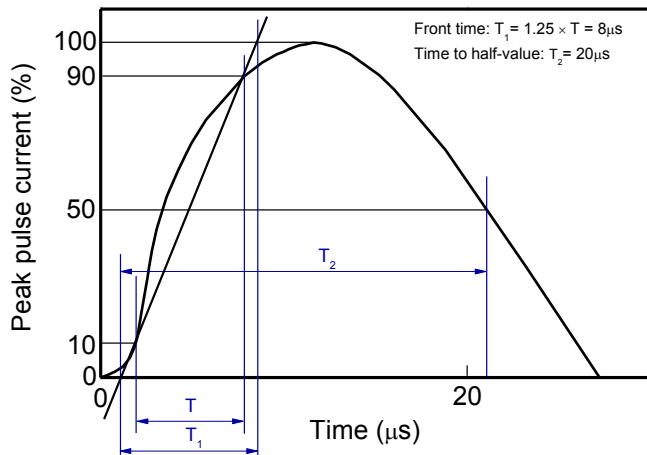
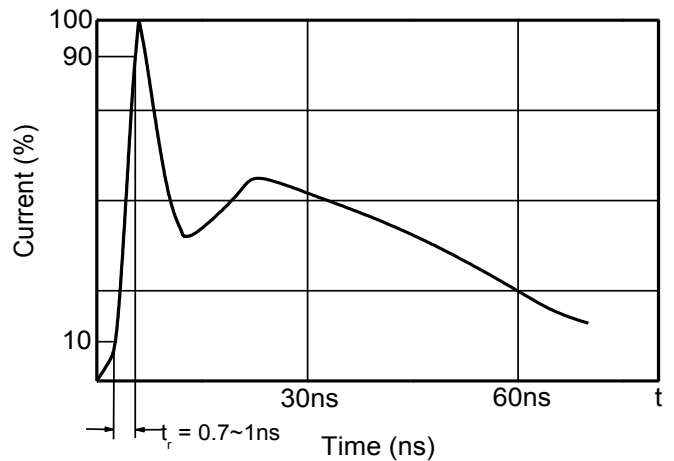
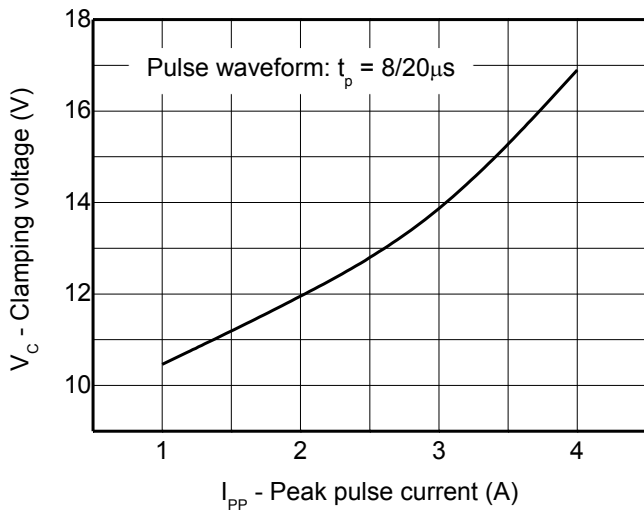
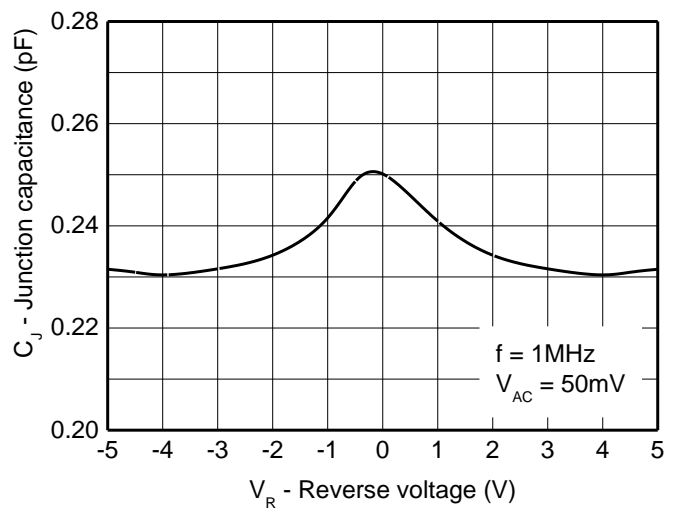
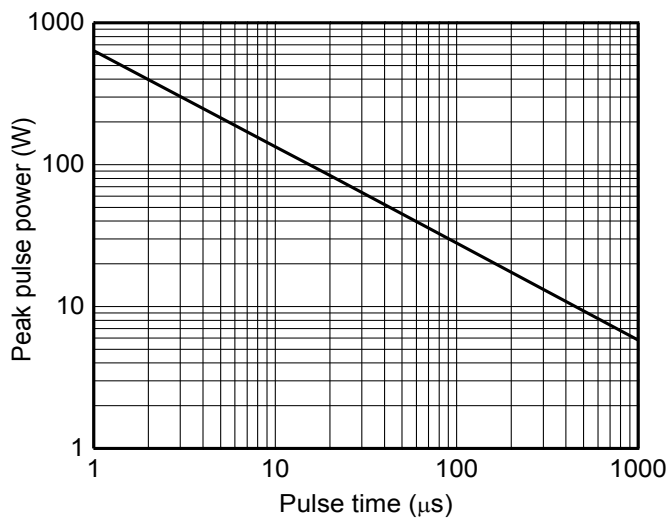
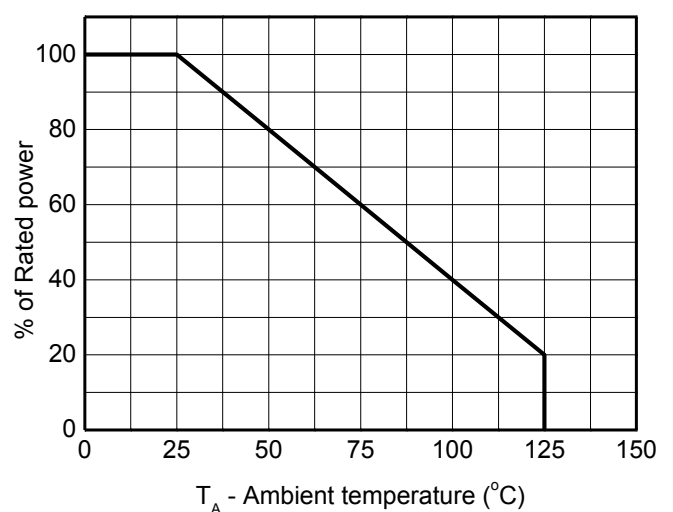
Typical characteristics ($T_A=25^\circ\text{C}$, unless otherwise noted)

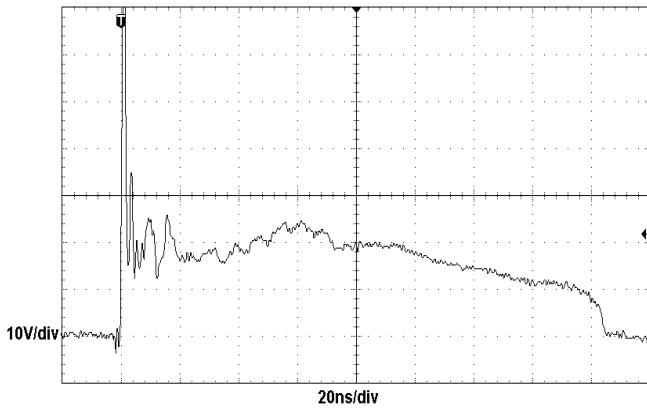
8/20 μs waveform per IEC61000-4-5

Contact discharge current waveform per IEC61000-4-2

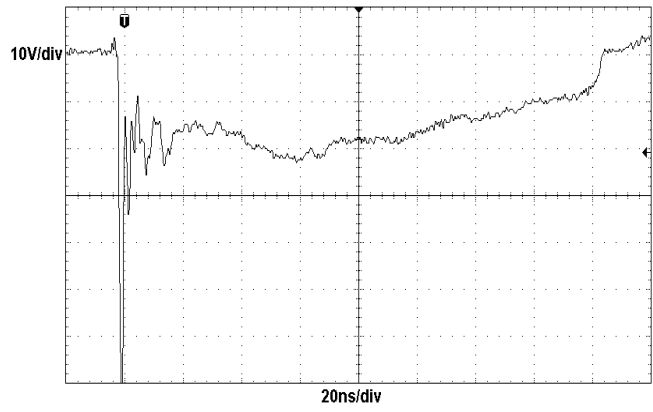
Clamping voltage vs. Peak pulse current

Capacitance vs. Reverse voltage

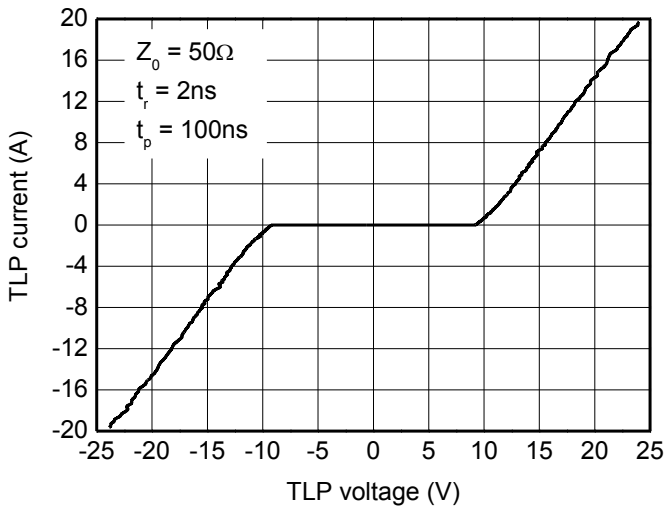
Non-repetitive peak pulse power vs. Pulse time

Power derating vs. Ambient temperature



ESD clamping
 (+8kV contact discharge per IEC61000-4-2)



ESD clamping
 (-8kV contact discharge per IEC61000-4-2)

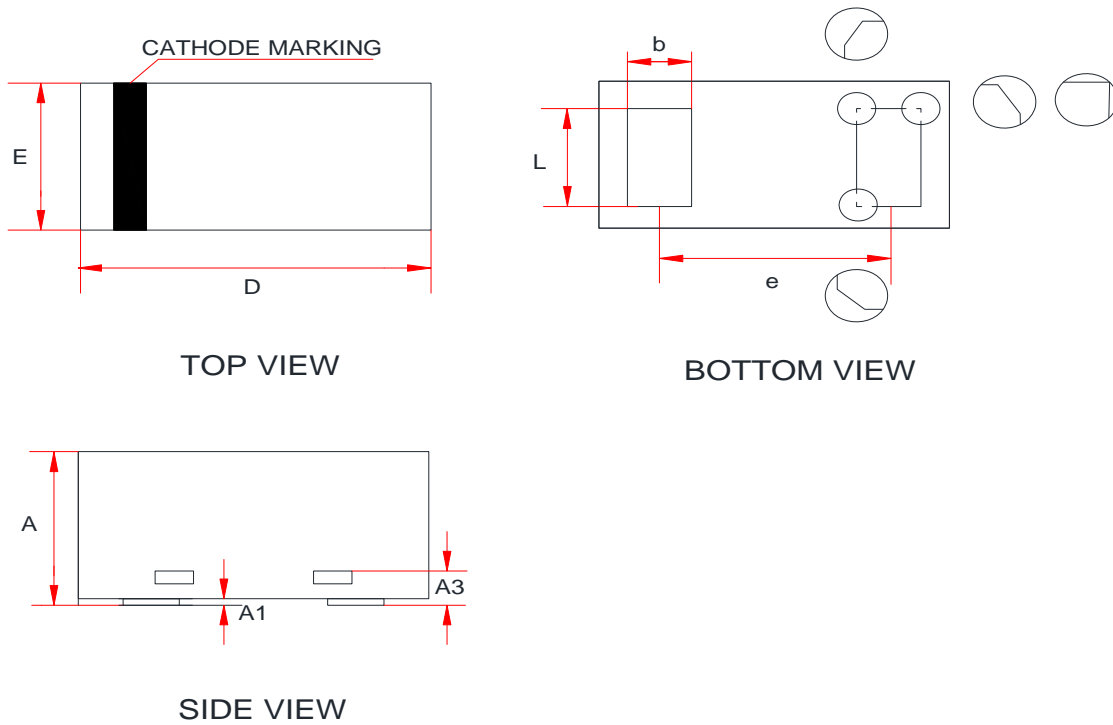

TLP Measurement

PACKAGE OUTLINE DIMENSIONS
DFN0603-2L

Symbol	Dimensions in Millimeters		
	Min.	Typ.	Max.
A	0.23	0.30	0.34
A1	0.00	0.03	0.05
A3	0.10 Ref.		
D	0.55	0.60	0.67
E	0.25	0.30	0.37
b	0.10	0.15	0.20
L	0.20	0.24	0.30
e	0.40 Ref		

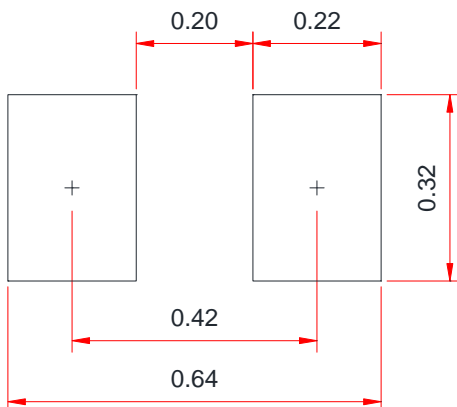
Recommended PCB Layout (Unit: mm)

Notes:

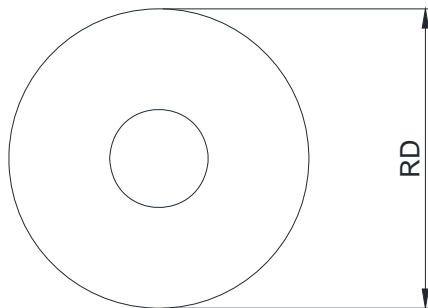
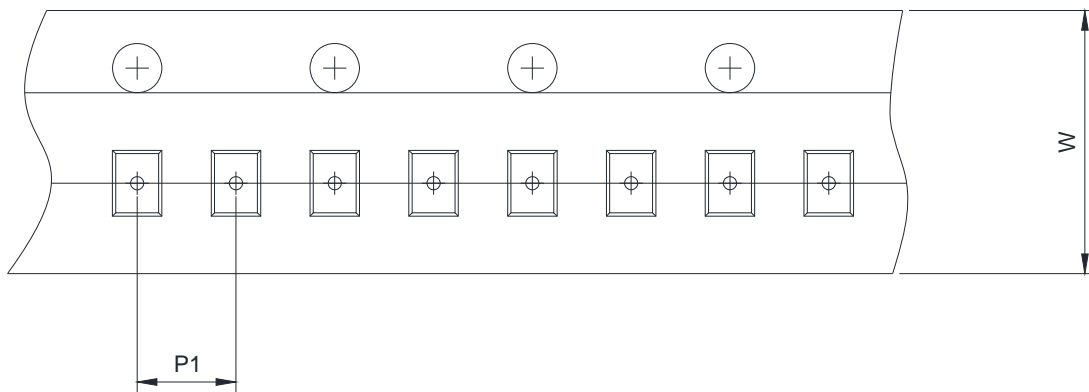
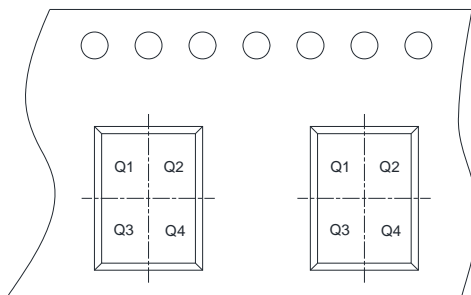
This recommended land pattern is for reference purposes only. Please consult your manufacturing group to ensure your PCB design guidelines are met.

TAPE AND REEL INFORMATION
Reel Dimensions

Tape Dimensions

Quadrant Assignments For PIN1 Orientation In Tape



 User Direction of Feed

RD	Reel Dimension	<input checked="" type="checkbox"/> 7inch	<input type="checkbox"/> 13inch
W	Overall width of the carrier tape	<input checked="" type="checkbox"/> 8mm	<input type="checkbox"/> 12mm <input type="checkbox"/> 16mm
P1	Pitch between successive cavity centers	<input checked="" type="checkbox"/> 2mm	<input type="checkbox"/> 4mm <input type="checkbox"/> 8mm
Pin1	Pin1 Quadrant	<input checked="" type="checkbox"/> Q1	<input checked="" type="checkbox"/> Q2 <input type="checkbox"/> Q3 <input type="checkbox"/> Q4

X-ON Electronics

Largest Supplier of Electrical and Electronic Components

Click to view similar products for [ESD Suppressors / TVS Diodes](#) category:

Click to view products by [Will Semiconductor](#) manufacturer:

Other Similar products are found below :

[60KS200C](#) [D18V0L1B2LP-7B](#) [D5V0F4U5P5-7](#) [DESD5V0U1BB-7](#) [NTE4902](#) [P4KE27CA](#) [P6KE11CA](#) [P6KE39CA-TP](#) [P6KE8.2A](#)
[SA110CA](#) [SA60CA](#) [SA64CA](#) [SMBJ12CATR](#) [SMBJ33CATR](#) [SMBJ8.0A](#) [ESD101-B1-02ELS E6327](#) [ESD105-B1-02EL E6327](#) [ESD112-B1-02EL E6327](#) [ESD119B1W01005E6327XTSA1](#) [ESD5V0L1B02VH6327XTSA1](#) [ESD7451N2T5G](#) [19180-510](#) [CPDT-5V0USP-HF](#)
[3.0SMCJ33CA-F](#) [3.0SMCJ36A-F](#) [HSPC16701B02TP](#) [D3V3Q1B2DLP3-7](#) [D55V0M1B2WS-7](#) [DESD5V0U1BL-7B](#) [DRTR5V0U4SL-7](#)
[SCM1293A-04SO](#) [ESD200-B1-CSP0201 E6327](#) [SM12-7](#) [SMF8.0A-TP](#) [SMLJ45CA-TP](#) [CEN955 W/DATA](#) [82350120560](#) [VESD12A1A-](#)
[HD1-GS08](#) [CPDUR5V0R-HF](#) [CPDQC5V0U-HF](#) [CPDQC5V0USP-HF](#) [CPDQC5V0-HF](#) [D1213A-01LP4-7B](#) [D1213A-02WL-7](#)
[MMAD1108/TR13](#) [5KP100A](#) [5KP15A](#) [5KP18A](#) [5KP48A](#) [5KP90A](#)