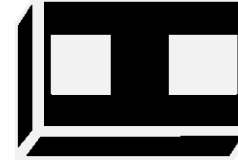
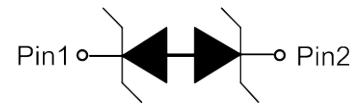

**ESD5451X**
**1-Line, Bi-directional, Transient Voltage Suppressors**
<http://www.sh-willsemi.com>
**Descriptions**

The ESD5451X is a bi-directional TVS (Transient Voltage Suppressor). It is specifically designed to protect sensitive electronic components which are connected to low speed data lines and control lines from over-stress caused by ESD (Electrostatic Discharge), EFT (Electrical Fast Transients) and Lightning.

The ESD5451X may be used to provide ESD protection up to  $\pm 30\text{kV}$  (contact and air discharge) according to IEC61000-4-2, and withstand peak pulse current up to 8A (8/20 $\mu\text{s}$ ) according to IEC61000-4-5.

The ESD5451X is available in FBP-02C package. Standard products are Pb-free and Halogen-free.

**FBP-02C (Bottom View)**

**Circuit diagram**
**Features**

- Reverse stand-off voltage:  $\pm 5\text{V}$  Max
- Transient protection for each line according to IEC61000-4-2 (ESD):  $\pm 30\text{kV}$  (contact and air discharge)  
IEC61000-4-4 (EFT): 40A (5/50ns)  
IEC61000-4-5 (surge): 8A (8/20 $\mu\text{s}$ )
- Capacitance:  $C_J = 17.5\text{pF}$  typ.
- Low leakage current:  $I_R < 1\text{nA}$  typ.
- Low clamping voltage:  $V_{CL} = 9\text{V}$  typ. @  $I_{PP} = 16\text{A}$  (TLP)
- Solid-state silicon technology



5 = Device code

\* = Month code ( A~Z)

**Marking (Top View)**
**Applications**

- Cellular handsets
- Tablets
- Laptops
- Other portable devices
- Network communication devices

**Order information**

Device	Package	Shipping
ESD5451X-2/TR	FBP-02C	10000/Tape&Reel

**Absolute maximum ratings**

Parameter	Symbol	Rating	Unit
Peak pulse power ( $t_p = 8/20\mu s$ )	$P_{pk}$	80	W
Peak pulse current ( $t_p = 8/20\mu s$ )	$I_{pp}$	8	A
ESD according to IEC61000-4-2 air discharge	$V_{ESD}$	$\pm 30$	kV
ESD according to IEC61000-4-2 contact discharge		$\pm 30$	
Operation junction temperature	$T_J$	125	$^{\circ}C$
Lead temperature	$T_L$	260	$^{\circ}C$
Storage temperature	$T_{STG}$	-55~150	$^{\circ}C$

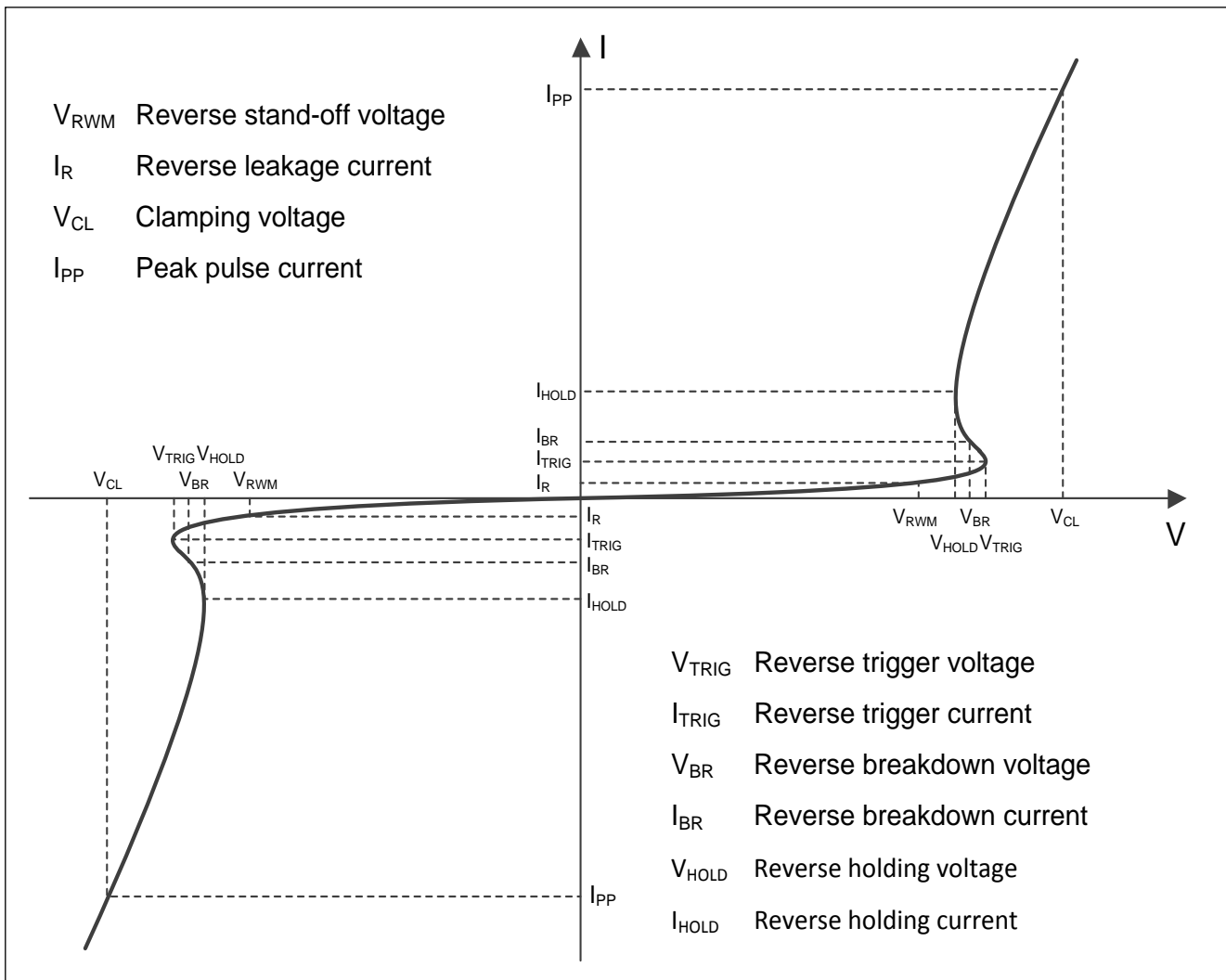
**Electrical characteristics ( $T_A=25^{\circ}C$ , unless otherwise noted)**

**Definitions of electrical characteristics**

**Electrical characteristics (T<sub>A</sub>=25 °C, unless otherwise noted)**

Parameter	Symbol	Condition	Min.	Typ.	Max.	Unit
Reverse stand-off voltage	V <sub>RWM</sub>				±5	V
Reverse leakage current	I <sub>R</sub>	V <sub>RWM</sub> = 5V		<1	100	nA
Reverse breakdown voltage	V <sub>BR</sub>	I <sub>BR</sub> = 1mA	5.1			V
Reverse holding voltage	V <sub>HOLD</sub>	I <sub>HOLD</sub> = 50mA	5.1			V
Clamping voltage <sup>1)</sup>	V <sub>CL</sub>	I <sub>PP</sub> = 16A, t <sub>p</sub> = 100ns		9		V
Clamping voltage <sup>2)</sup>	V <sub>CL</sub>	V <sub>ESD</sub> = 8kV		9		V
Clamping voltage <sup>3)</sup>	V <sub>CL</sub>	I <sub>PP</sub> = 1A, t <sub>p</sub> = 8/20μs			6.5	V
		I <sub>PP</sub> = 5A, t <sub>p</sub> = 8/20μs			8.5	V
		I <sub>PP</sub> = 8A, t <sub>p</sub> = 8/20μs			10	V
Dynamic resistance <sup>1)</sup>	R <sub>DYN</sub>			0.20		Ω
Junction capacitance	C <sub>J</sub>	V <sub>R</sub> = 0V, f = 1MHz		17.5	22	pF
		V <sub>R</sub> = 5V, f = 1MHz		11.5	16	pF

**Notes:**

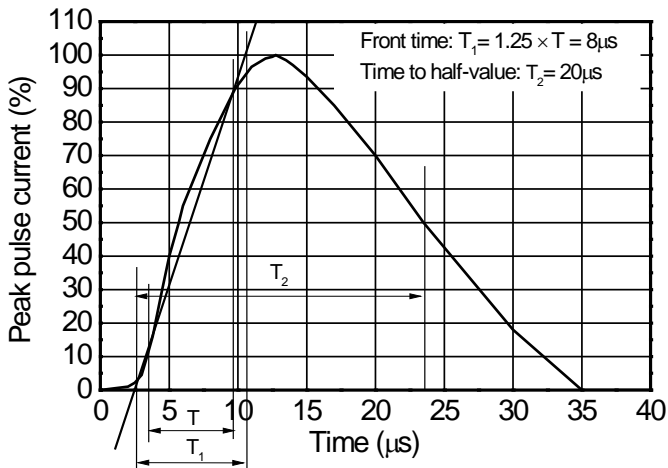
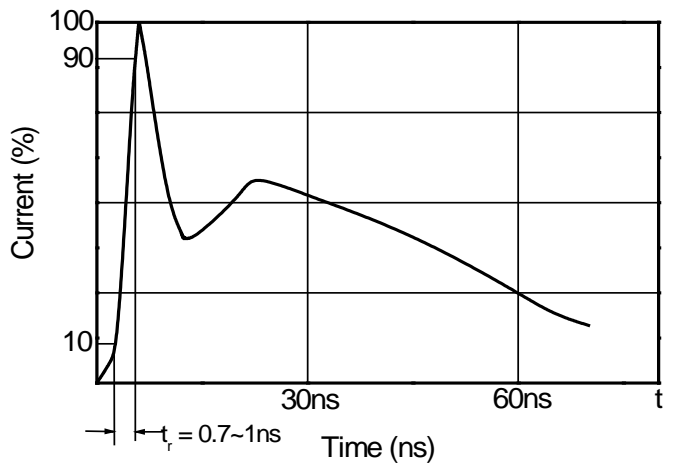
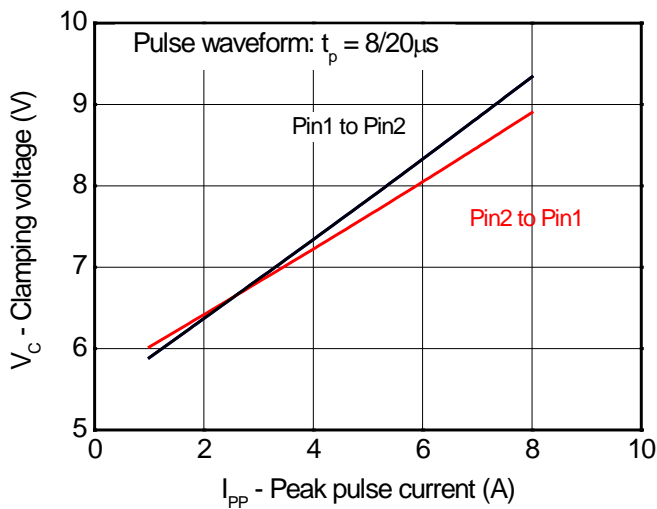
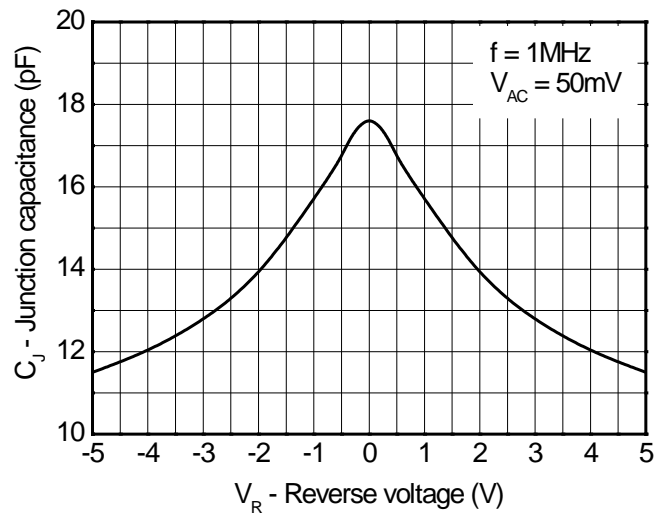
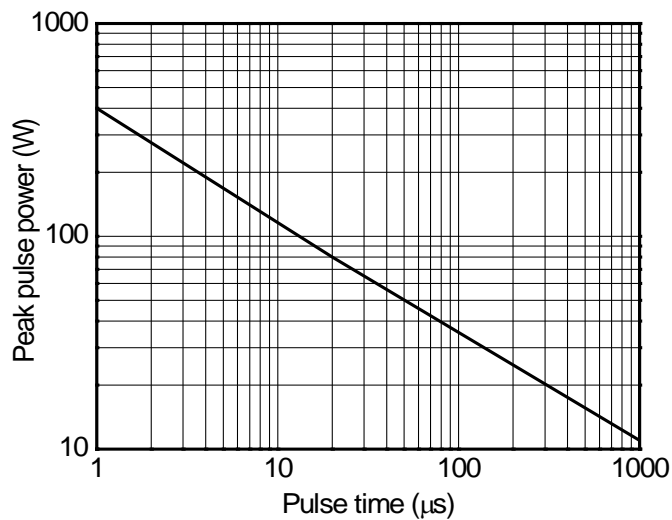
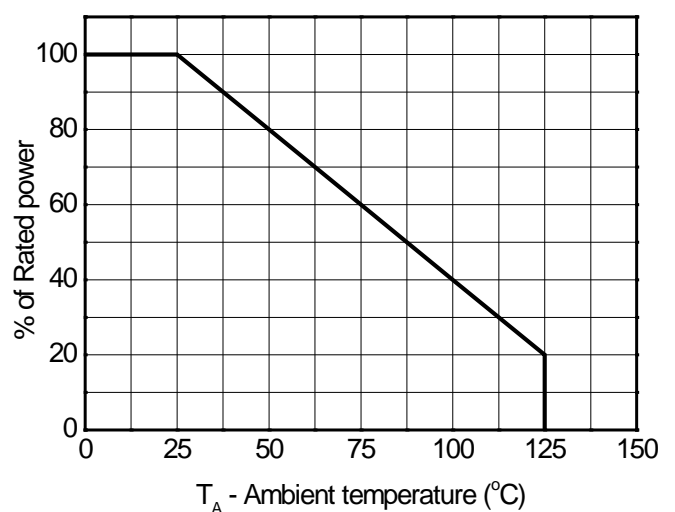
- 1) TLP parameter: Z<sub>0</sub> = 50Ω, t<sub>p</sub> = 100ns, t<sub>r</sub> = 2ns, averaging window from 60ns to 80ns. R<sub>DYN</sub> is calculated from 4A to 16A.
- 2) Contact discharge mode, according to IEC61000-4-2.
- 3) Non-repetitive current pulse, according to IEC61000-4-5.

**Typical characteristics ( $T_A=25^\circ\text{C}$ , unless otherwise noted)**

**8/20 $\mu\text{s}$  waveform per IEC61000-4-5**

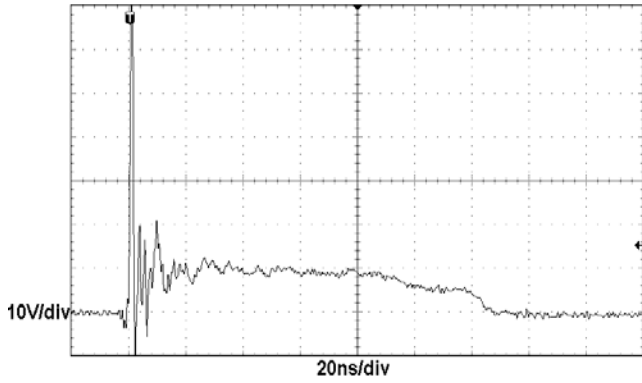
**Contact discharge current waveform per IEC61000-4-2**

**Clamping voltage vs. Peak pulse current**

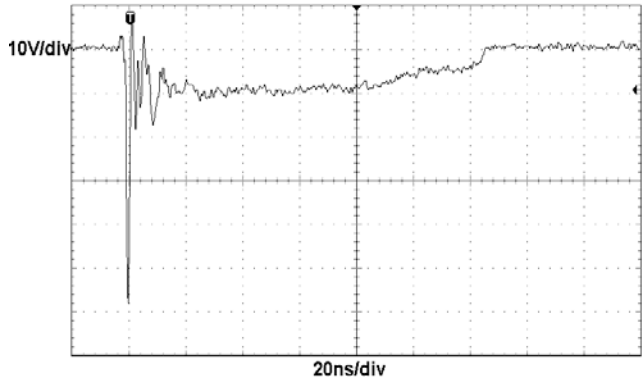
**Capacitance vs. Reverses voltage**

**Non-repetitive peak pulse power vs. Pulse time**

**Power derating vs. Ambient temperature**

Typical characteristics ( $T_A=25^\circ\text{C}$ , unless otherwise noted)



**ESD clamping**  
(+8kV contact discharge per IEC61000-4-2)



**ESD clamping**  
(-8kV contact discharge per IEC61000-4-2)

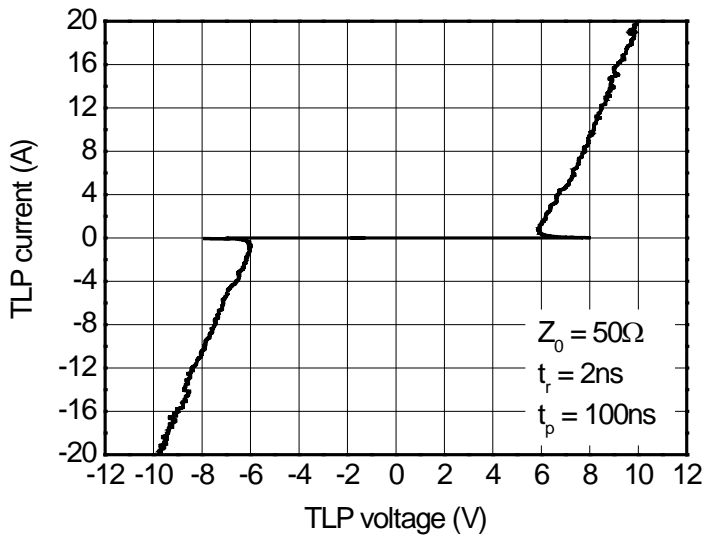

**TLP Measurement**

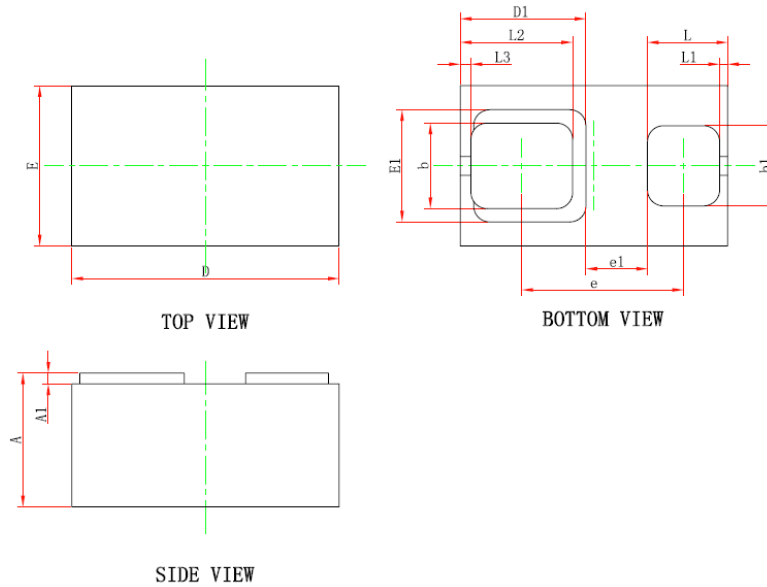
**Package outline dimensions**
**FBP-02C**

Symbol	Dimensions In Millimeters		
	Min.	Typ.	Max.
A	0.450	0.500	0.550
A1	0.010	--	0.100
D	0.950	1.000	1.050
E	0.550	0.600	0.650
D1	0.470 Ref.		
E1	0.420 Ref.		
b	0.270	0.320	0.370
b1	0.250	0.300	0.350
e	0.555	0.605	0.655
e1	0.230 Ref.		
L	0.250	0.300	0.350
L1	0.030 Ref.		
L2	0.370	0.420	0.470
L3	0.040 Ref.		

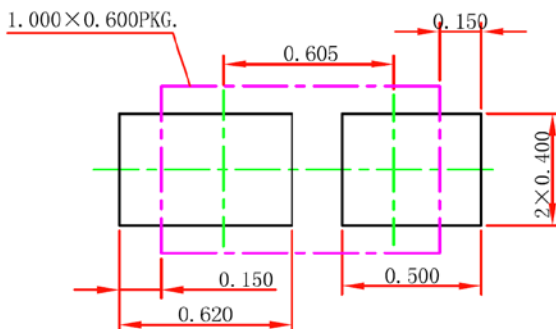
**Recommend land pattern (Unit: mm)**

**Notes:**

This recommended land pattern is for reference purposes only. Please consult your manufacturing group to ensure your PCB design guidelines are met.

## X-ON Electronics

Largest Supplier of Electrical and Electronic Components

*Click to view similar products for [ESD Suppressors / TVS Diodes](#) category:*

*Click to view products by [Will Semiconductor](#) manufacturer:*

Other Similar products are found below :

[60KS200C](#) [D18V0L1B2LP-7B](#) [D5V0F4U5P5-7](#) [DESD5V0U1BB-7](#) [NTE4902](#) [P4KE27CA](#) [P6KE11CA](#) [P6KE39CA-TP](#) [P6KE8.2A](#)  
[SA110CA](#) [SA60CA](#) [SA64CA](#) [SMBJ12CATR](#) [SMBJ33CATR](#) [SMBJ8.0A](#) [ESD101-B1-02ELS E6327](#) [ESD105-B1-02EL E6327](#) [ESD112-B1-02EL E6327](#) [ESD119B1W01005E6327XTSA1](#) [ESD5V0L1B02VH6327XTSA1](#) [ESD7451N2T5G](#) [19180-510](#) [CPDT-5V0USP-HF](#)  
[3.0SMCJ33CA-F](#) [3.0SMCJ36A-F](#) [HSPC16701B02TP](#) [D3V3Q1B2DLP3-7](#) [D55V0M1B2WS-7](#) [DESD5V0U1BL-7B](#) [DRTR5V0U4SL-7](#)  
[SCM1293A-04SO](#) [ESD200-B1-CSP0201 E6327](#) [SM12-7](#) [SMF8.0A-TP](#) [SMLJ45CA-TP](#) [CEN955 W/DATA](#) [82350120560](#) [VESD12A1A-](#)  
[HD1-GS08](#) [CPDUR5V0R-HF](#) [CPDQC5V0U-HF](#) [CPDQC5V0USP-HF](#) [CPDQC5V0-HF](#) [D1213A-01LP4-7B](#) [D1213A-02WL-7](#)  
[MMAD1108/TR13](#) [5KP100A](#) [5KP15A](#) [5KP18A](#) [5KP48A](#) [5KP90A](#)