

ESD56161D04
1-Line, Uni-directional, Transient Voltage Suppressor
<http://www.sh-willsemi.com>
Descriptions

The ESD56161D04 is a uni-directional Transient Voltage Suppressor designed to protect power interfaces. It is suitable to replace multiple discrete components in portable electronics.

The ESD56161D04 may be used to provide ESD protection up to $\pm 30\text{kV}$ contact and air discharge according to IEC61000-4-2, and withstand peak pulse current up to 250A according to IEC61000-4-5 (8/20 μs).

The ESD56161D04 is available in DFN2x2-3L package. Standard products are Pb-free and Halogen-free.

Features

- Reverse stand-off voltage: 4.5V Max.
- ESD protection according to IEC61000-4-2
Contact & Air discharge: $\pm 30\text{kV}$
- Surge protection according to IEC61000-4-5
8/20 μs waveform: 250A
- Capacitance: $C_J = 4200\text{pF}$ Typ.
- Low clamping voltage
- Solid-state silicon technology

Applications

- Power supply protection
- Power management

Order information

Device	Package	Shipping
ESD56161D04-3/TR	DFN2x2-3L	3000/Tape&Reel

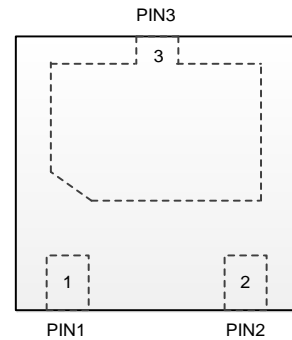
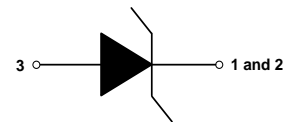
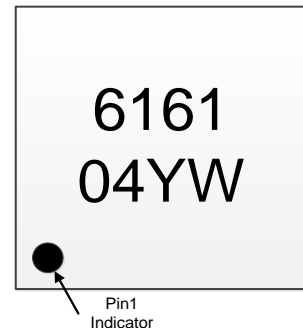

Pin configuration

Circuit diagram

6161 = Series code
 04 = Device code
 YW = Date code

Marking

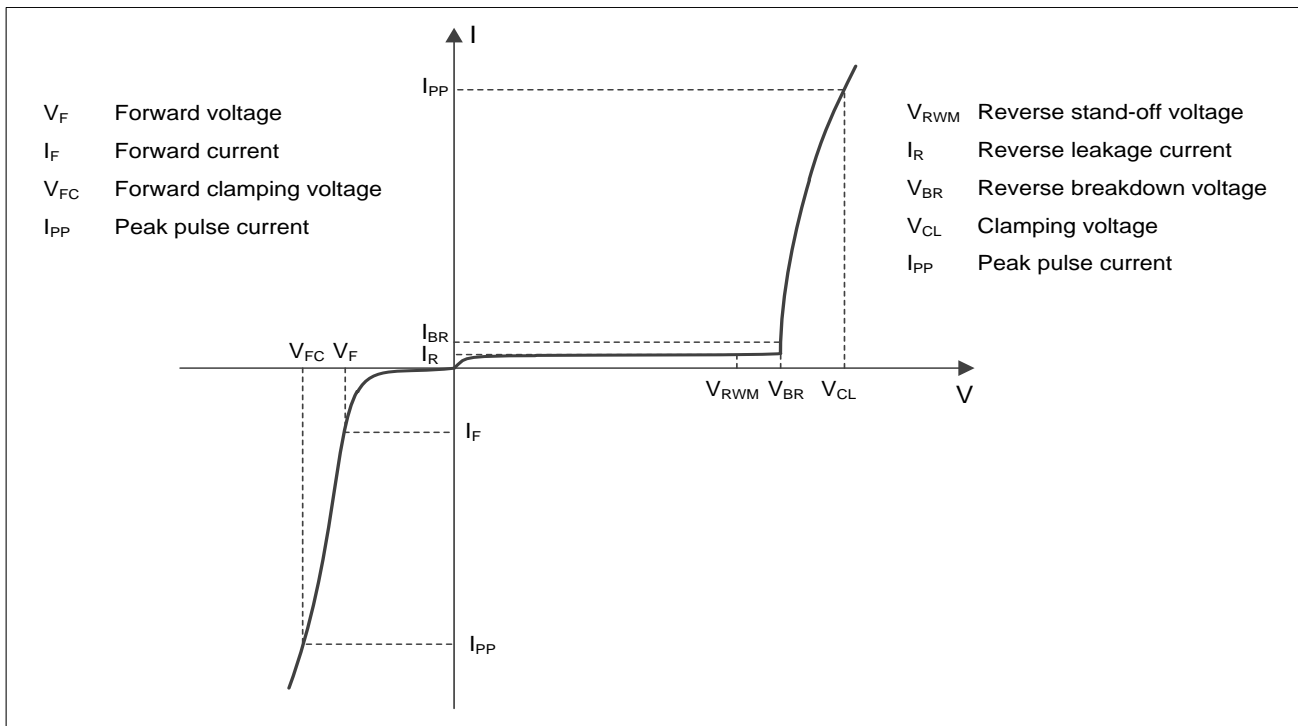
Absolute maximum ratings

Parameter	Symbol	Rating	Unit
Peak pulse power ($t_p = 8/20\mu s$)	P_{pk}	3500	W
Peak pulse current ($t_p = 8/20\mu s$)	I_{PP}	250	A
ESD according to IEC61000-4-2 air discharge	V_{ESD}	± 30	kV
ESD according to IEC61000-4-2 contact discharge		± 30	
Junction temperature	T_J	125	$^{\circ}C$
Operating temperature	T_{OP}	-40~85	$^{\circ}C$
Lead temperature	T_L	260	$^{\circ}C$
Storage temperature	T_{STG}	-55~150	$^{\circ}C$

Electrical characteristics ($T_A = 25^{\circ}C$, unless otherwise noted)

Definitions of electrical characteristics

Electrical characteristics (TA = 25 °C, unless otherwise noted)

Parameter	Symbol	Condition	Min.	Typ.	Max.	Unit
Reverse stand-off voltage	V_{RWM}				4.5	V
Reverse leakage current	I_R	$V_{RWM} = 4.5V$			8	μA
Reverse breakdown voltage	V_{BR}	$I_{BR} = 1mA$	5.1	5.7	6.3	V
Forward voltage	V_F	$I_F = 20mA$	0.5	0.8	1.1	V
Clamping voltage ²⁾	V_{CL}	$I_{PP} = 1A, t_p = 8/20\mu s$			7	V
		$I_{PP} = 100A, t_p = 8/20\mu s$			10	V
		$I_{PP} = 250A, t_p = 8/20\mu s$			14	V
Junction capacitance	C_J	$V_R = 0V, f = 1MHz,$		4200	5000	pF
		$V_R = 4.5V, f = 1MHz$		2000	2500	pF

Notes:

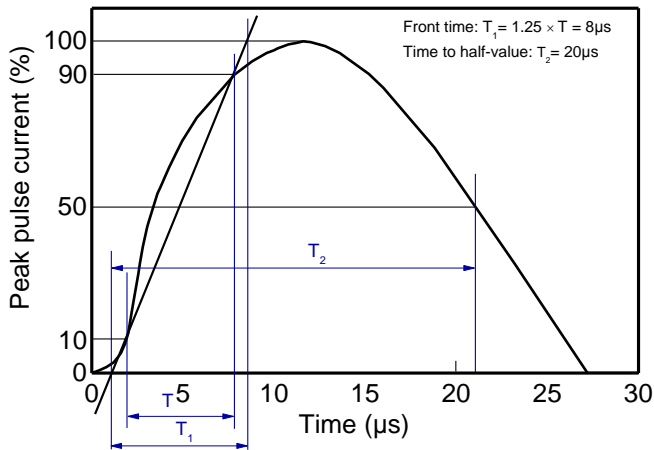
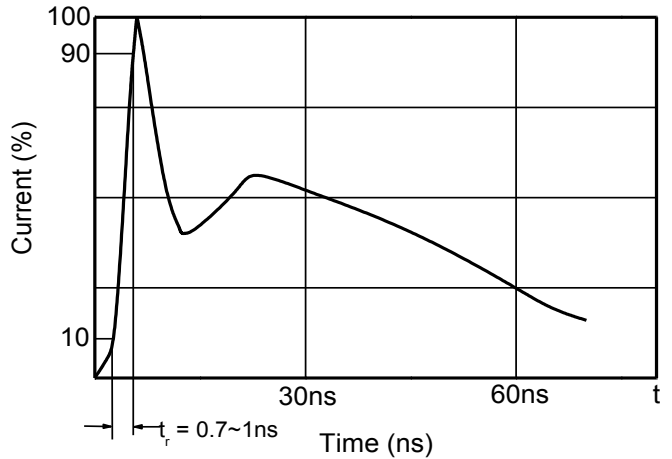
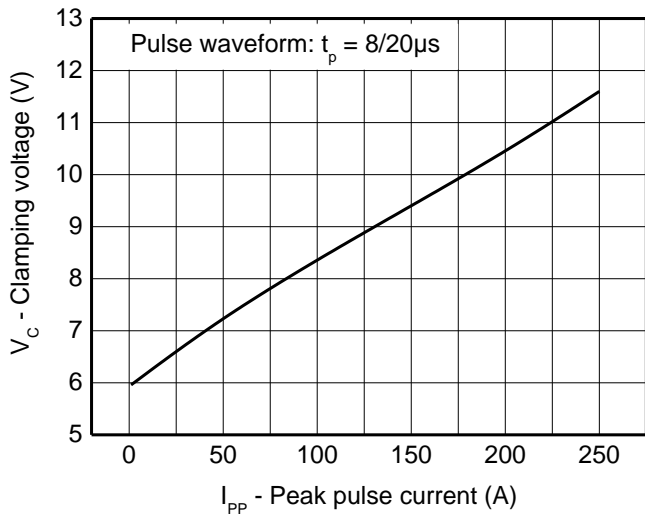
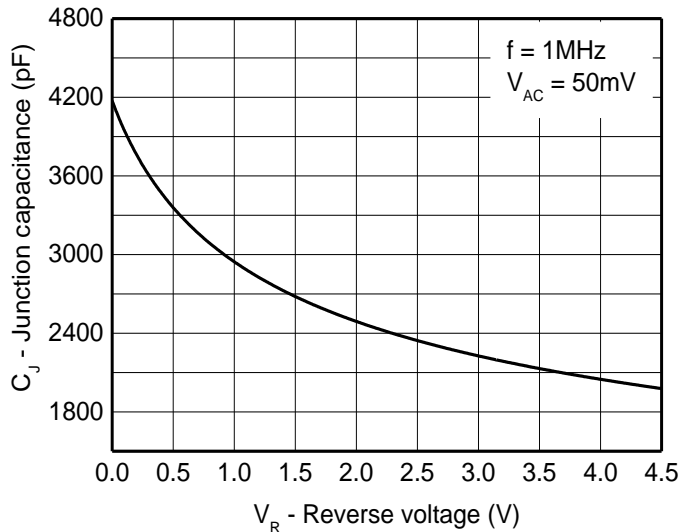
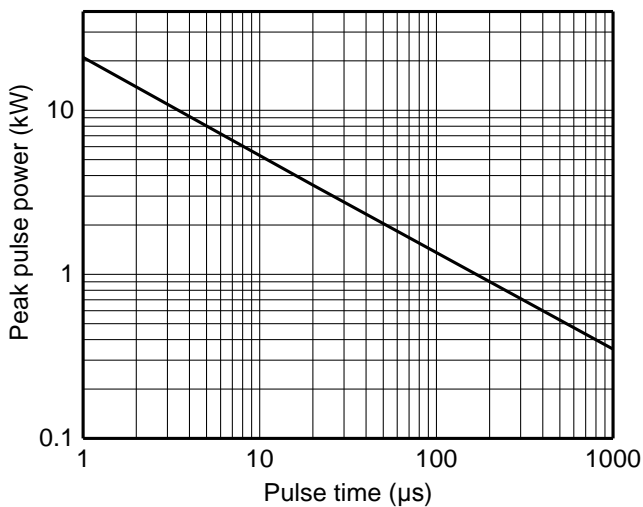
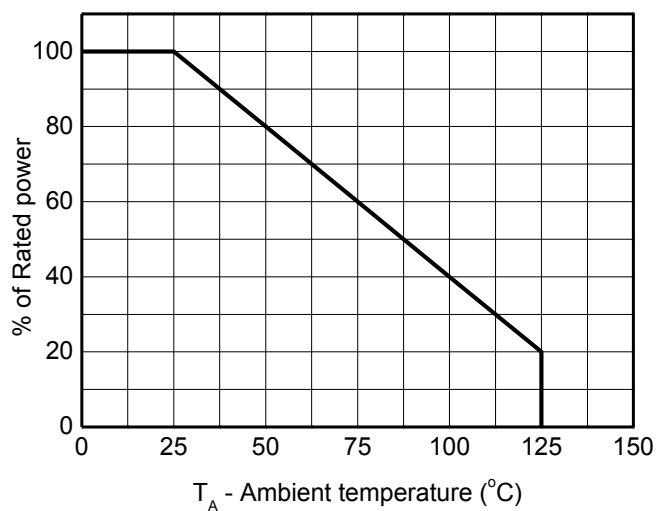
- 1) Contact discharge mode, according to IEC61000-4-2.
- 2) Non-repetitive current pulse, according to IEC61000-4-5.

Typical characteristics ($T_A = 25^\circ\text{C}$, unless otherwise noted)

8/20 μs waveform per IEC61000-4-5

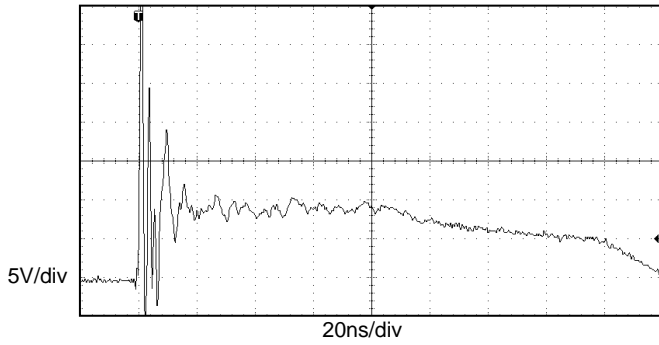
Contact discharge current waveform per IEC61000-4-2

Clamping voltage vs. Peak pulse current

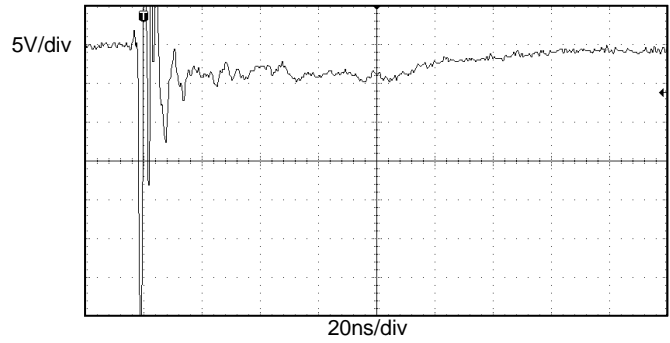
Capacitance vs. Reverse voltage

Non-repetitive peak pulse power vs. Pulse time

Power derating vs. Ambient temperature

Typical characteristics ($T_A=25^\circ\text{C}$, unless otherwise noted)



ESD clamping
(+8kV contact discharge per IEC61000-4-2)

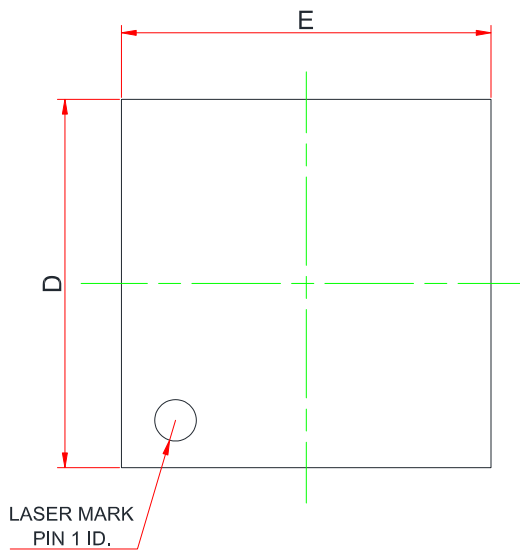
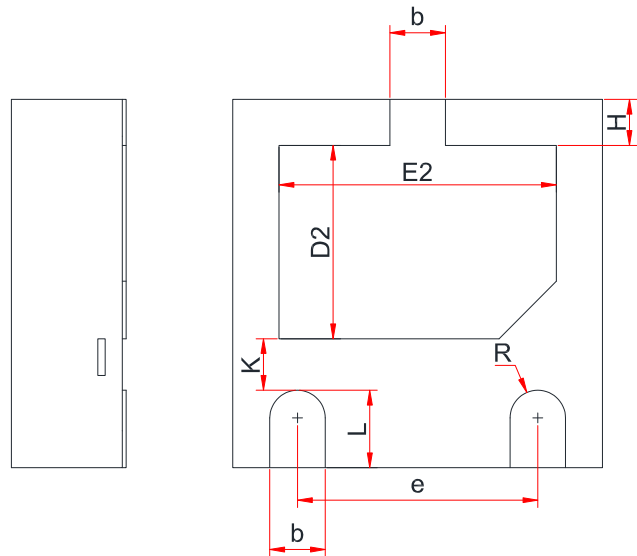
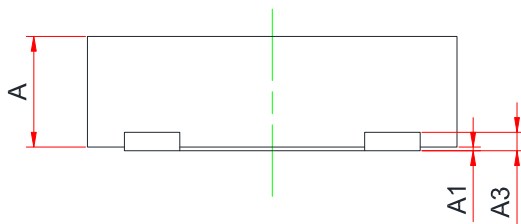
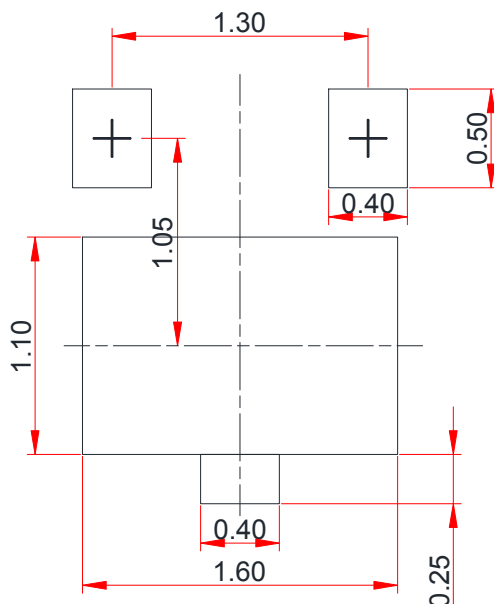

ESD clamping
(-8kV contact discharge per IEC61000-4-2)

Package outline dimensions
DFN2x2-3L

Top View

Bottom View

Side View
Recommended land pattern (Unit: mm)

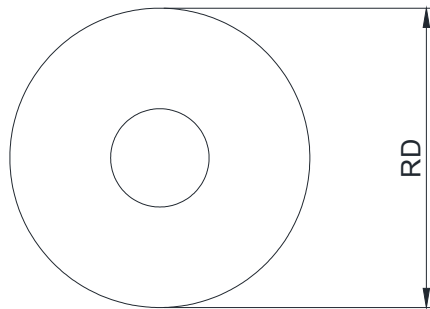
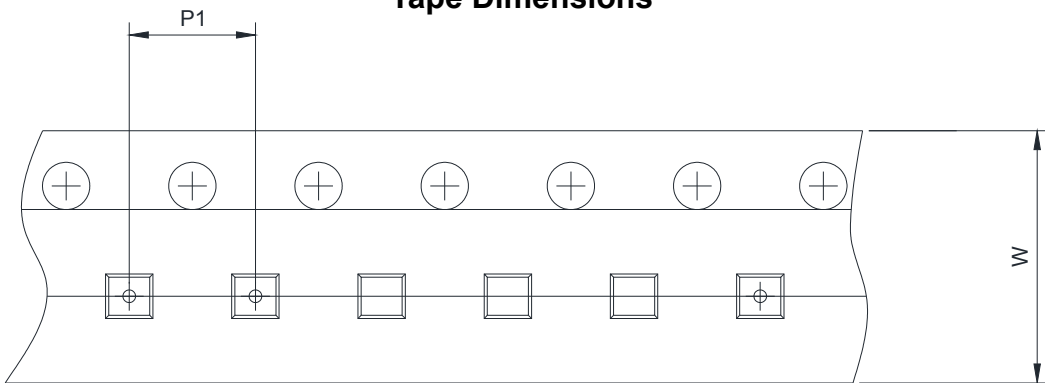
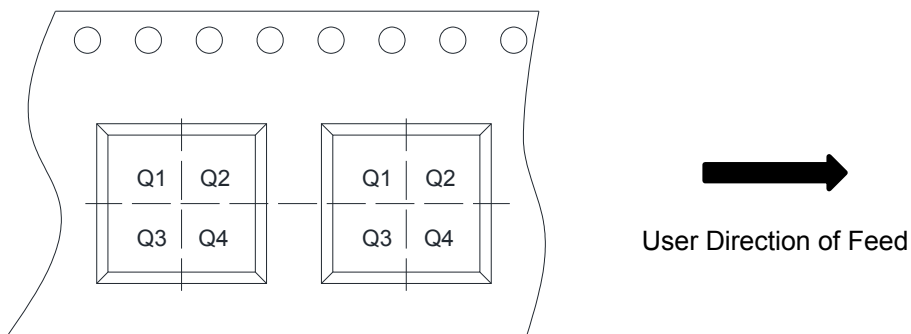
Symbol	Dimensions In Millimeters		
	Min.	Typ.	Max.
A	0.55	0.60	0.65
A1	0.00	0.02	0.05
A3	0.10 REF.		
b	0.25	0.30	0.35
D	1.90	2.00	2.10
E	1.90	2.00	2.10
D2	0.95	1.05	1.15
E2	1.40	1.50	1.60
e	1.20	1.30	1.40
H	0.20	0.25	0.30
K	0.20	0.30	0.40
L	0.35	0.40	0.45
R	0.13	-	-

Notes:

This recommended land pattern is for reference purposes only. Please consult your manufacturing group to ensure your PCB design guidelines are met.

TAPE AND REEL INFORMATION
Reel Dimensions

Tape Dimensions

Quadrant Assignments For PIN1 Orientation In Tape

RD	Reel Dimension	<input checked="" type="checkbox"/> 7inch	<input type="checkbox"/> 13inch		
W	Overall width of the carrier tape	<input checked="" type="checkbox"/> 8mm	<input type="checkbox"/> 12mm		
P1	Pitch between successive cavity centers	<input type="checkbox"/> 2mm	<input checked="" type="checkbox"/> 4mm	<input type="checkbox"/> 8mm	
Pin1	Pin1 Quadrant	<input type="checkbox"/> Q1	<input checked="" type="checkbox"/> Q2	<input type="checkbox"/> Q3	<input type="checkbox"/> Q4

X-ON Electronics

Largest Supplier of Electrical and Electronic Components

Click to view similar products for [ESD Suppressors / TVS Diodes](#) category:

Click to view products by [Will Semiconductor](#) manufacturer:

Other Similar products are found below :

[NTE4902](#) [P4SMAJ15A](#) [P4SMAJ26A](#) [SMAJ400CA-TP](#) [TGL34-47CA](#) [ESDAULC45-1BF4](#) [SM1605E3/TR13](#) [SMF20A-TP](#) [P4SMAJ12A](#)
[CPDUR24V-HF](#) [CPDQC5V0USP-HF](#) [CPDQC5V0-HF](#) [MPLAD30KP45CAE3](#) [MMBZ27VCLQ-7-F](#) [MMAD1108/TR13](#) [MPLAD30KP24A](#)
[ACPDQC5V0R-HF](#) [DFLT170A-7](#) [NTE4900](#) [NTE4926](#) [NTE4938](#) [SMF22A-TP](#) [SMF12A-TP](#) [SLVU2.8-TP](#) [SMLJ6.5CA-TP](#) [SMAJ6.5CA-](#)
[TP](#) [MMAD1108E3/TR13](#) [D5V0M1U2LP3-7](#) [SMAJ400A-TP](#) [AOZ8811DT-03](#) [AOZ8831DI-05](#) [AOZ8831DT-03](#) [SMAJ188CA](#) [3SMC33CA](#)
[BK](#) [CPDQC3V3C-HF](#) [CPDQC12VE-HF](#) [MPLAD30KP170CA](#) [82357120100](#) [5.0SMLJ15CA-TP](#) [5KP18A-TP](#) [P6KE8.2A-TP](#)
[MPLAD30KP43CAE3](#) [SMAJ43A-TP](#) [D5V0F6U8LP33-7](#) [TVS5501V10MUT5G](#) [5.0SMLJ24CA-TP](#) [SMAJ110CA-TP](#) [MPLAD15KP75CAE3](#)
[MMAD1103e3/TR13](#) [DFLT40AQ-7](#)