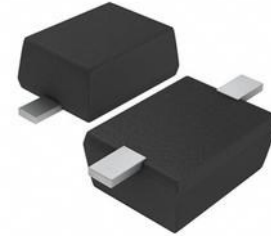
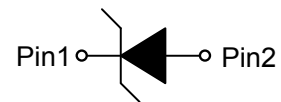

ESD5621WXX
1-Line, Uni-directional, Transient Voltage Suppressor
<http://www.sh-willsemi.com>
Descriptions

The ESD5621WXX is a uni-directional TVS (Transient Voltage Suppressor). It is specifically designed to protect sensitive electronic components which are connected to power lines, from over-stress caused by ESD (Electrostatic Discharge), EFT (Electrical Fast Transients) and Lightning.

The ESD5621WXX may be used to provide ESD protection up to $\pm 30\text{kV}$ (contact and air discharge) according to IEC61000-4-2, and with high surge capability used to protect USB voltage bus pin ($8/20\mu\text{s}$) according to IEC61000-4-5.

The ESD5621WXX is available in SOD-323F package. Standard products are Pb-free and Halogen-free.

SOD-323F (Bottom View)

Circuit diagram
Features

- Reverse stand-off voltage: 4.5V ~ 15V
- Surge protection according to IEC61000-4-5 see [Table 4](#)
- ESD protection according to IEC61000-4-2 $\pm 30\text{kV}$ (contact and air discharge)
- Low clamping voltage
- Solid-state silicon technology

Applications

- Power supply protection
- Power management

Order information
Table 1.

Device	Package	Shipping	Marking
ESD5621W04-2/TR	SOD-323F	3000/Tape&Reel	TE*
ESD5621W10-2/TR	SOD-323F	3000/Tape&Reel	TJ*
ESD5621W-2/TR	SOD-323F	3000/Tape&Reel	Q*
ESD5621W15-2/TR	SOD-323F	3000/Tape&Reel	TD*

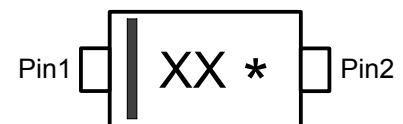

XX = Device code

* = Month code

Marking (Top View)

Absolute maximum ratings
Table 2.

Parameter	Symbol	Rating	Unit
Peak pulse power ($t_p=8/20\mu s$)	Ppk	1400	W
ESD according to IEC61000-4-2 air discharge	V_{ESD}	± 30	kV
ESD according to IEC61000-4-2 contact discharge		± 30	
Junction temperature	T_J	125	$^{\circ}C$
Operating temperature	T_{OP}	-40~85	$^{\circ}C$
Lead temperature	T_L	260	$^{\circ}C$
Storage temperature	T_{STG}	-55~150	$^{\circ}C$

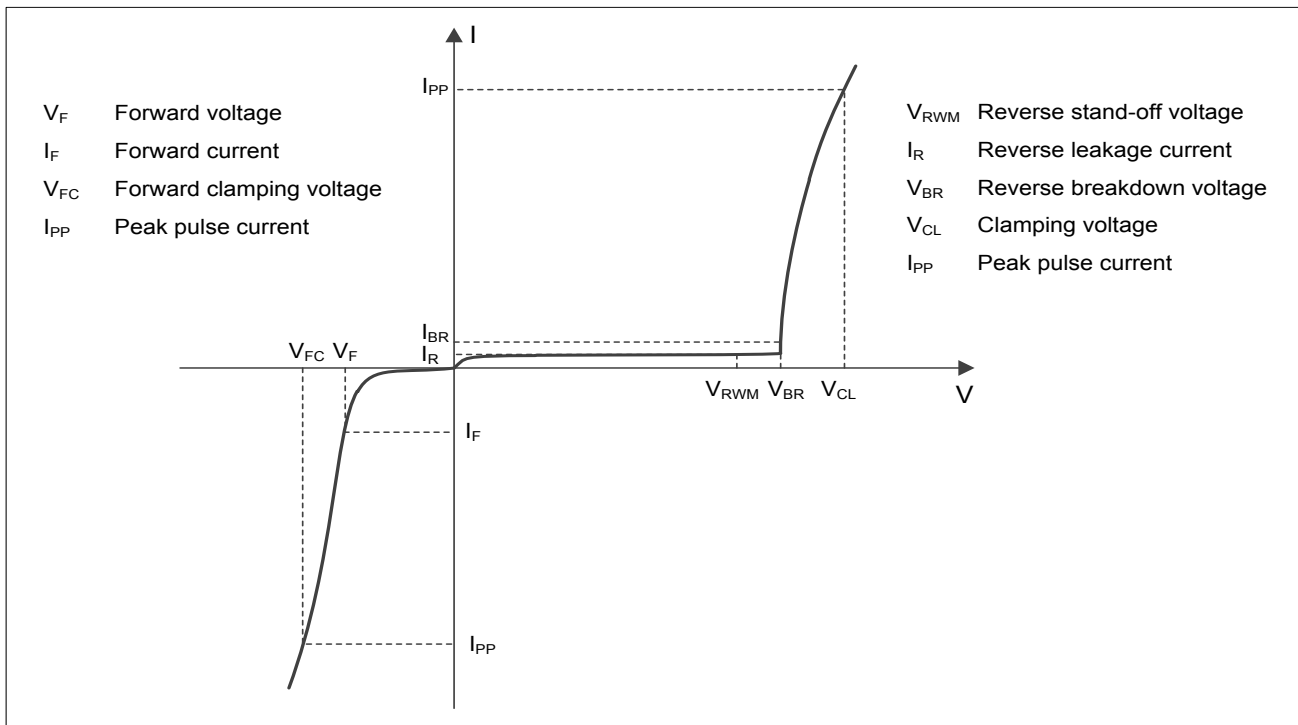
Electrical characteristics ($T_A = 25^{\circ}C$, unless otherwise noted)

Definitions of electrical characteristics

Electrical characteristics ($T_A = 25^\circ\text{C}$, unless otherwise noted)
Table 3.

Type number	Reverse Standoff Voltage V_{RWM} (V)	Breakdown voltage V_{BR} (V) $I_{BR} = 1\text{mA}$			Reverse leakage current I_{RM} (μA) at V_{RWM}		Forward voltage V_F (V) $I_F = 20\text{mA}$		Junction capacitance $F = 1\text{MHz}$, $V_R = 0\text{V}$ (pF)	
	Max	Min	Typ	Max	Typ	Max	Min	Max	Typ	Max
ESD5621W04	4.5	5.2	6.1	7.0	-	5.0	0.45	1.25	900	1200
ESD5621W10	10.0	11.5	13.2	15.0		0.1	0.45	1.25	350	500
ESD5621W	12.0	13.0	15.0	17.0	-	0.1	0.45	1.25	300	400
ESD5621W15	15.0	16.0	18.0	20.0	-	0.1	0.45	1.25	270	350

Table 4.

Type number	Rated peak pulse current I_{PP} (A) ¹⁾³⁾	Clamping voltage V_{CL} (V) at I_{PP} (A) ¹⁾³⁾	Clamping voltage V_{CL} (V) at $I_{PP} = 16\text{A}$, $t_p = 100\text{ns}$ ²⁾³⁾	Clamping voltage V_{CL} (V) at $V_{ESD} = 8\text{kV}$ ²⁾³⁾
ESD5621W04	95	14.5	7.0	8.0
ESD5621W10	60	25.0	15.0	16.0
ESD5621W	50	27.5	16.0	17.0
ESD5621W15	45	31.0	20.0	21.0

Notes:

- 1) Non-repetitive current pulse, according to IEC61000-4-5.(8/20 μs current waveform)
- 2) Non-repetitive current pulse, according to IEC61000-4-2.
- 3) Measured from pin 1 to pin 2.

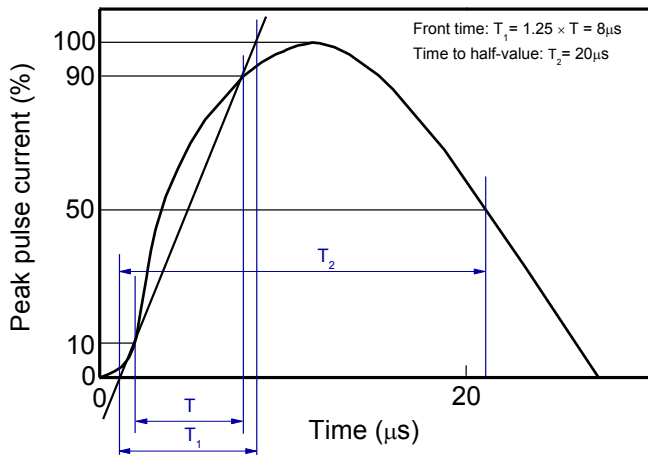
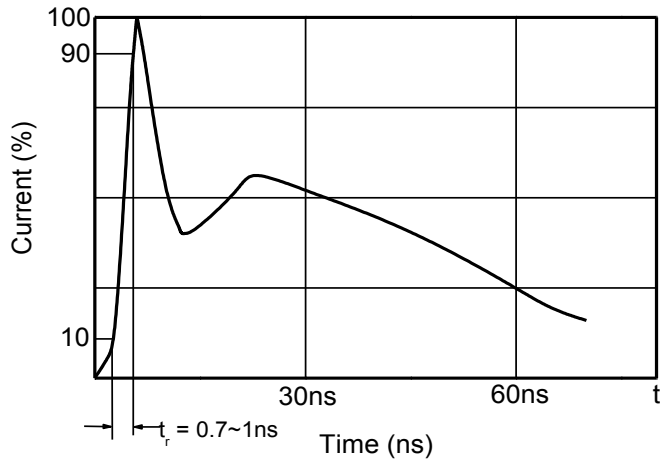
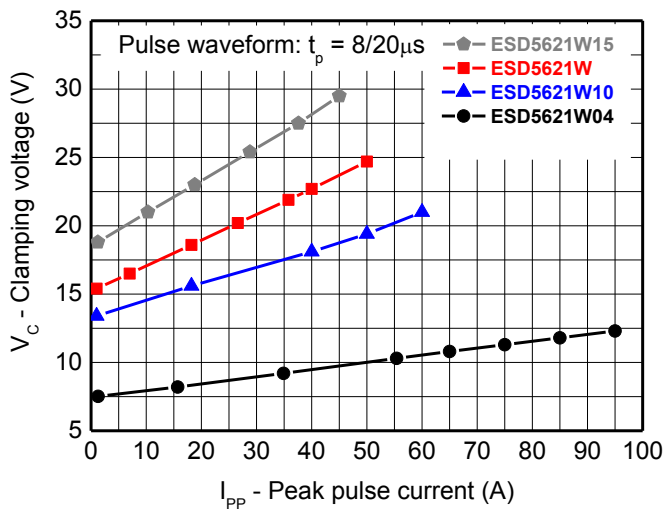
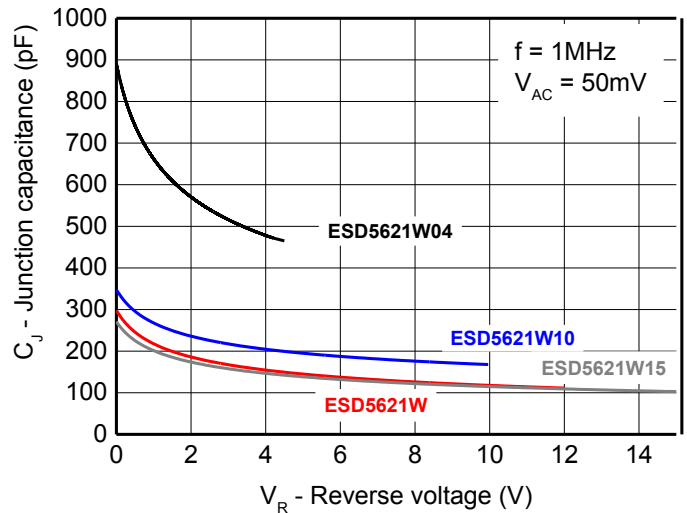
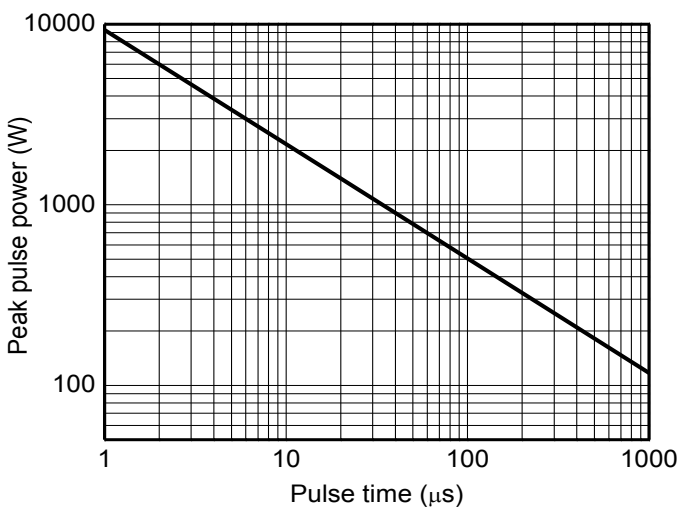
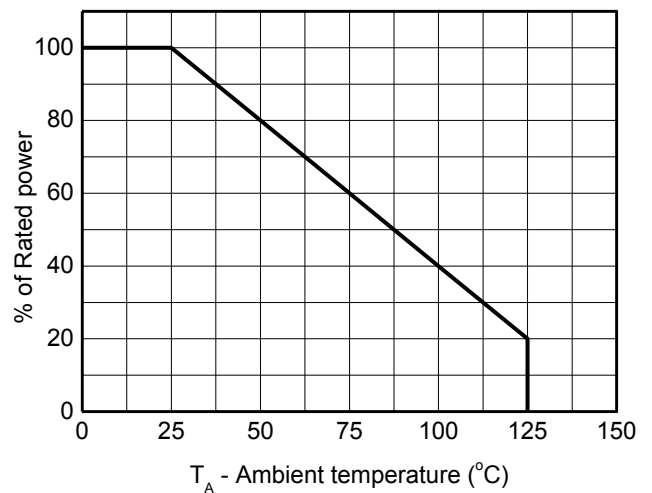
Typical characteristics ($T_A = 25^\circ\text{C}$, unless otherwise noted)

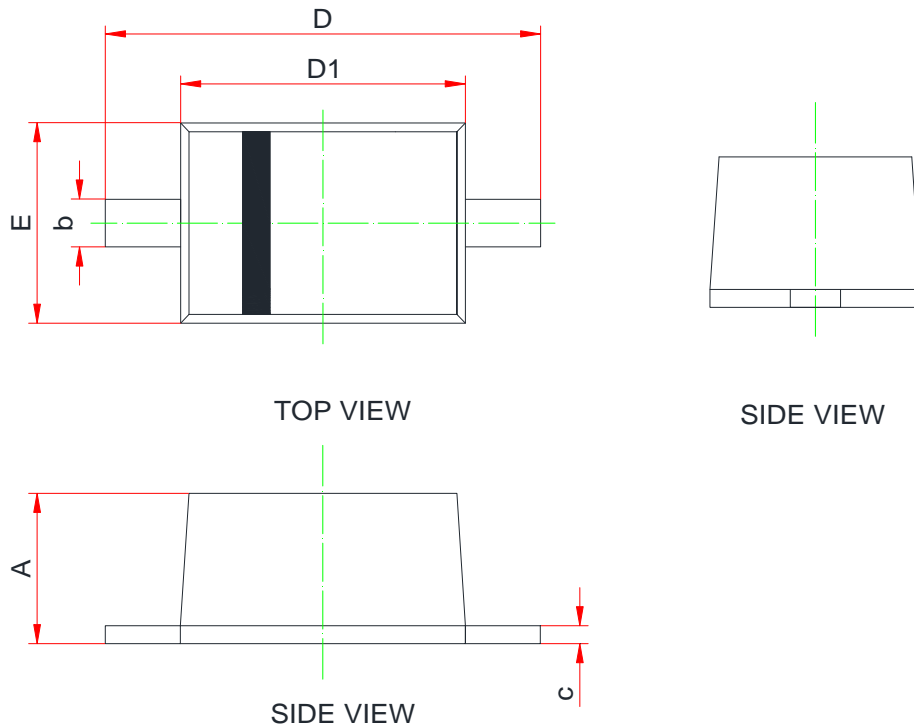
8/20 μs waveform per IEC61000-4-5

Contact discharge current waveform per IEC61000-4-2

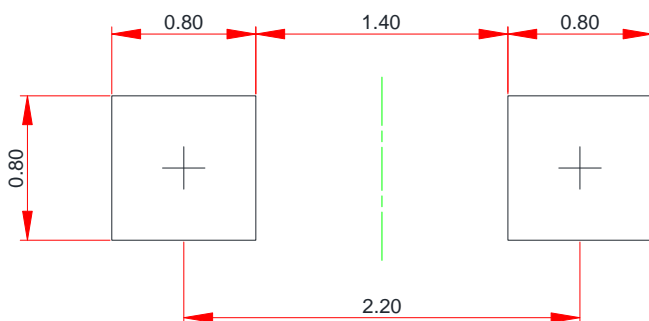
Clamping voltage vs. Peak pulse current

Capacitance vs. Reverse voltage

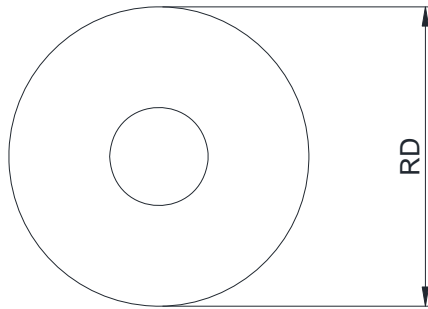
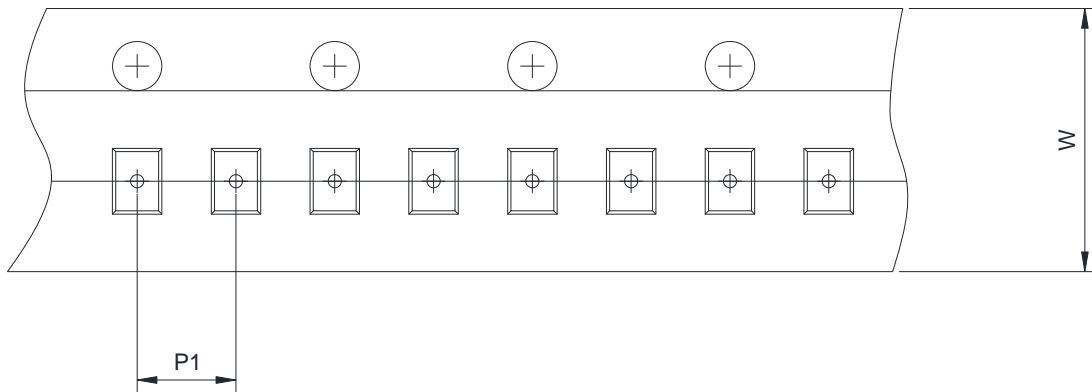
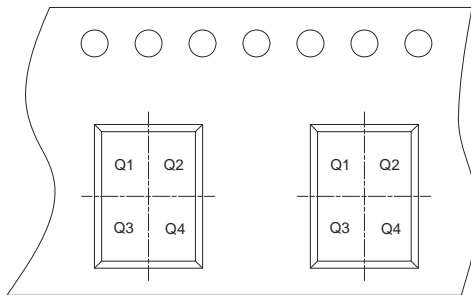
Non-repetitive peak pulse power vs. Pulse time

Power derating vs. Ambient temperature

PACKAGE OUTLINE DIMENSIONS
SOD-323F

Symbol	Dimensions in Millimeters		
	Min.	Typ.	Max.
A	0.60	-	1.10
c	0.08	0.13	0.18
b	0.25	-	0.40
D1	1.60	1.70	1.80
E	1.15	1.25	1.35
D	2.30	-	2.80

Recommend land pattern (Unit: mm)

Notes:

This recommended land pattern is for reference purposes only. Please consult your manufacturing group to ensure your PCB design guidelines are met.

TAPE AND REEL INFORMATION
Reel Dimensions

Tape Dimensions

Quadrant Assignments For PIN1 Orientation In Tape



 User Direction of Feed

RD	Reel Dimension	<input checked="" type="checkbox"/> 7inch	<input type="checkbox"/> 13inch
W	Overall width of the carrier tape	<input checked="" type="checkbox"/> 8mm	<input type="checkbox"/> 12mm <input type="checkbox"/> 16mm
P1	Pitch between successive cavity centers	<input type="checkbox"/> 2mm	<input checked="" type="checkbox"/> 4mm <input type="checkbox"/> 8mm
Pin1	Pin1 Quadrant	<input checked="" type="checkbox"/> Q1	<input checked="" type="checkbox"/> Q2 <input type="checkbox"/> Q3 <input type="checkbox"/> Q4

X-ON Electronics

Largest Supplier of Electrical and Electronic Components

Click to view similar products for [ESD Suppressors / TVS Diodes](#) category:

Click to view products by [Will Semiconductor](#) manufacturer:

Other Similar products are found below :

[NTE4902](#) [P4SMAJ15A](#) [P4SMAJ26A](#) [SMAJ400CA-TP](#) [TGL34-47CA](#) [ESDAULC45-1BF4](#) [SM1605E3/TR13](#) [SMF20A-TP](#) [P4SMAJ12A](#)
[CPDUR24V-HF](#) [CPDQC5V0USP-HF](#) [CPDQC5V0-HF](#) [MPLAD30KP45CAE3](#) [MMBZ27VCLQ-7-F](#) [MMAD1108/TR13](#) [MPLAD30KP24A](#)
[ACPDQC5V0R-HF](#) [DFLT170A-7](#) [NTE4900](#) [NTE4926](#) [NTE4938](#) [SMF22A-TP](#) [SMF12A-TP](#) [SLVU2.8-TP](#) [SMLJ6.5CA-TP](#) [SMAJ6.5CA-TP](#)
[MMAD1108E3/TR13](#) [D5V0M1U2LP3-7](#) [SMAJ400A-TP](#) [AOZ8811DT-03](#) [AOZ8831DI-05](#) [AOZ8831DT-03](#) [SMAJ188CA](#) [3SMC33CA](#)
[BK](#) [CPDQC3V3C-HF](#) [CPDQC12VE-HF](#) [MPLAD30KP170CA](#) [82357120100](#) [5.0SMLJ15CA-TP](#) [5KP18A-TP](#) [P6KE8.2A-TP](#)
[MPLAD30KP43CAE3](#) [SMAJ43A-TP](#) [D5V0F6U8LP33-7](#) [TVS5501V10MUT5G](#) [5.0SMLJ24CA-TP](#) [SMAJ110CA-TP](#) [MPLAD15KP75CAE3](#)
[MMAD1103e3/TR13](#) [DFLT40AQ-7](#)