

ESD5641DXX
1-Line, Uni-directional, Transient Voltage Suppressor
<http://www.sh-willsemi.com>
Descriptions

The ESD5641DXX is a transient voltage suppressor designed to protect power interfaces. It is suitable to replace multiple discrete components in portable electronics.

The ESD5641DXX is specifically designed to protect USB port. TVS diode with higher surge capability is used to protect USB voltage bus pin.

The ESD5641DXX is available in DFN2x2-3L package. Standard products are Pb-free and Halogen-free.

Features

- Reverse stand-off voltage: 7.5V ~ 15V
- Surge protection according to IEC61000-4-5
8/20μs waveform: I_{PPM} see [Table 4](#)
- Surge protection according to IEC61643-321
10/1000μs waveform: I_{PPM} see [Table 4](#)
- Low clamping voltage
- Solid-state silicon technology

Applications

- Power supply protection
- Power management

Order information
Table 1.

Device	Package	Shipping	Device code
ESD5641D07-3/TR	DFN2x2-3L	3000/Tape&Reel	07
ESD5641D10-3/TR	DFN2x2-3L	3000/Tape&Reel	10
ESD5641D12-3/TR	DFN2x2-3L	3000/Tape&Reel	12
ESD5641D15-3/TR	DFN2x2-3L	3000/Tape&Reel	15

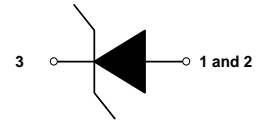
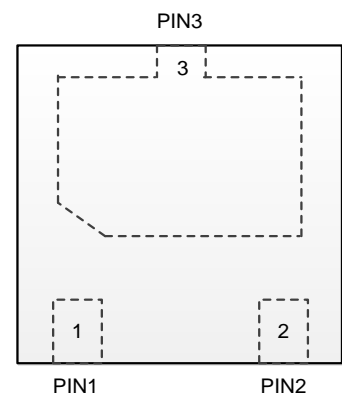
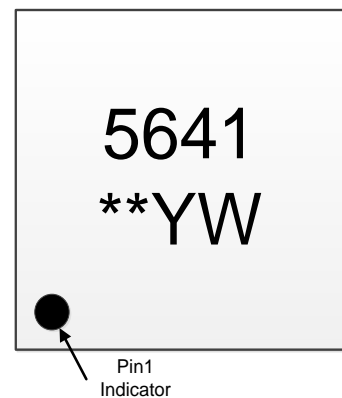
Circuit diagram

Pin configuration (Top View)

5641 = Series code
 ** = Device code
 YW = Date code

Marking

Absolute maximum ratings
Table 2.

Parameter	Symbol	Rating	Unit
Peak pulse power ($t_p=8/20\mu s$) ¹⁾³⁾	P_{PK}	4000	W
Peak pulse power ($t_p=10/1000\mu s$) ²⁾³⁾	P_{PK}	350	W
ESD according to IEC61000-4-2 air discharge	V_{ESD}	± 30	kV
ESD according to IEC61000-4-2 contact discharge		± 30	
Junction temperature	T_J	125	$^{\circ}C$
Operating temperature	T_{OP}	-40~85	$^{\circ}C$
Lead temperature	T_L	260	$^{\circ}C$
Storage temperature	T_{STG}	-55~150	$^{\circ}C$

Notes:

- 1) Non-repetitive current pulse, according to IEC61000-4-5. (8/20 μs current waveform)
- 2) Non-repetitive current pulse, according to IEC61643-321. (10/1000 μs current waveform)
- 3) Measured from pin 3 to pin 1 and pin 2.

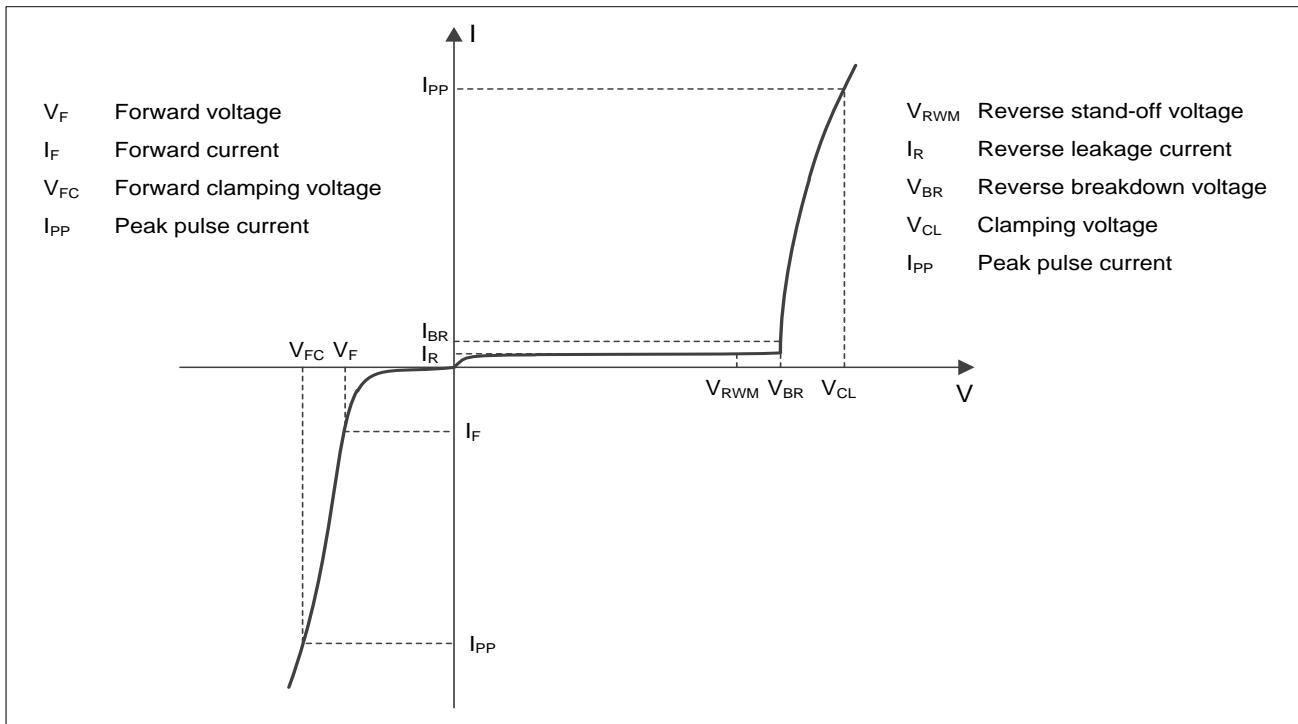
Electrical characteristics ($T_A = 25^{\circ}C$, unless otherwise noted)

Definitions of electrical characteristics

Electrical characteristics ($T_A = 25^\circ\text{C}$, unless otherwise noted)
Table 3.

Type number	Reverse Standoff Voltage V_{RWM} (V)	Breakdown voltage $V_{BR}(V)$ $I_{BR} = 1\text{mA}$			Reverse leakage current $I_{RM}(nA)$ at V_{RWM}		Forward voltage $V_F(V)$ $I_F = 20\text{mA}$		Junction capacitance $F=1\text{MHz}$, $V_R=0V$ (pF)	
	Max.	Min.	Typ.	Max.	Typ.	Max.	Min.	Max.	Typ.	Max.
ESD5641D07	7.5	8.0	9.0	10.0	10	1000	0.45	1.25	2200	3000
ESD5641D10	10.0	11.5	13.5	15.5	1	500	0.45	1.25	1500	2000
ESD5641D12	12.0	13.0	15.0	17.0	1	100	0.45	1.25	1200	1800
ESD5641D15	15.0	16.0	17.5	19.0	1	100	0.45	1.25	1000	1500

Table 4.

Type number	Rated peak pulse current I_{PP} (A) ¹⁾³⁾	Clamping voltage $V_{CL}(V)$ at I_{PP} (A) ¹⁾³⁾	Rated peak pulse current I_{PP} (A) ²⁾³⁾	Clamping voltage $V_{CL}(V)$ at I_{PP} (A) ²⁾³⁾
	Max.	Max.	Max.	Max.
ESD5641D07	190	18	28	13
ESD5641D10	170	23	22	18
ESD5641D12	150	27	16	20
ESD5641D15	130	30	13	25

Notes:

- 1) Non-repetitive current pulse, according to IEC61000-4-5. (8/20 μs current waveform)
- 2) Non-repetitive current pulse, according to IEC61643-321. (10/1000 μs current waveform)
- 3) Measured from pin 3 to pin 1 and pin 2.

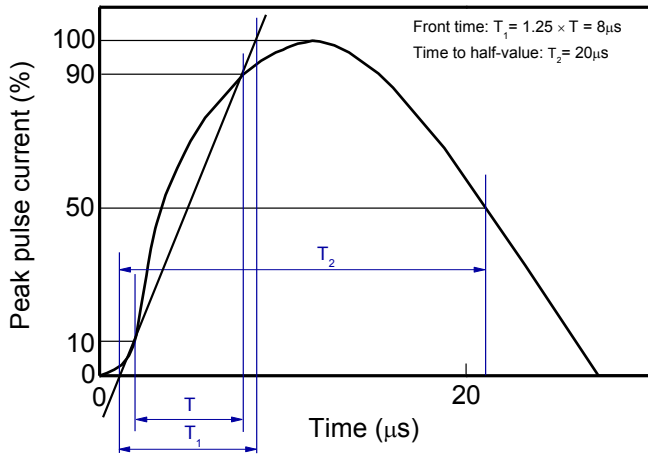
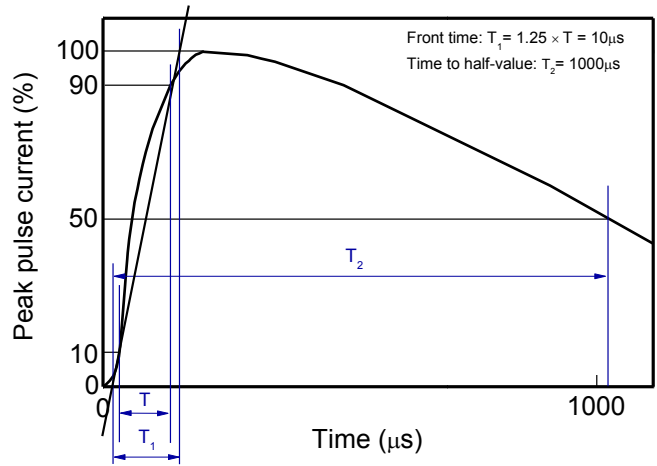
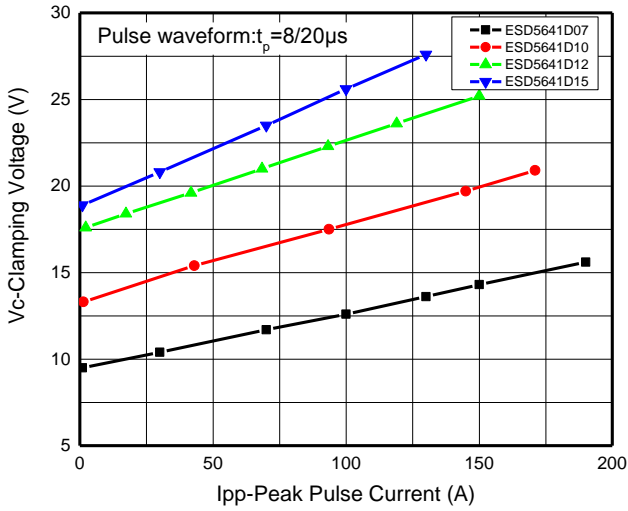
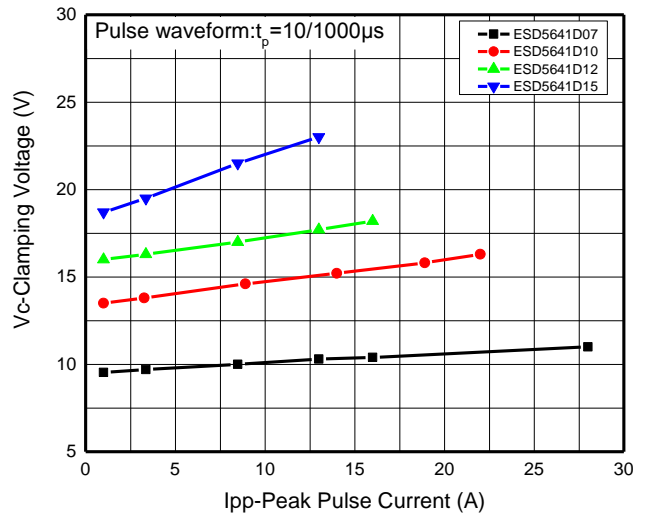
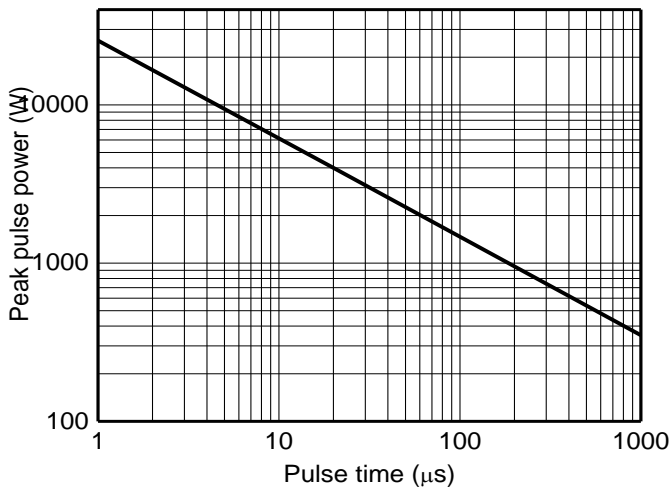
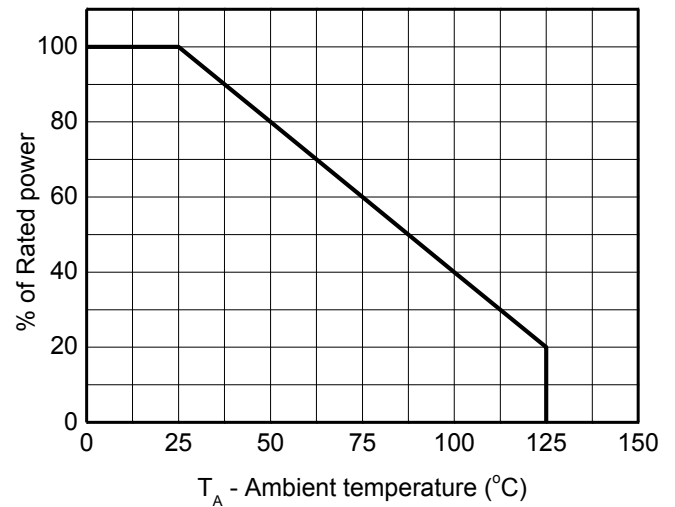
Typical characteristics ($T_A = 25^\circ\text{C}$, unless otherwise noted)

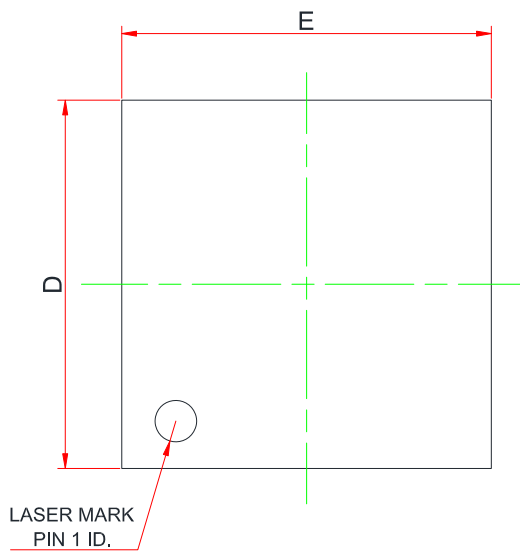
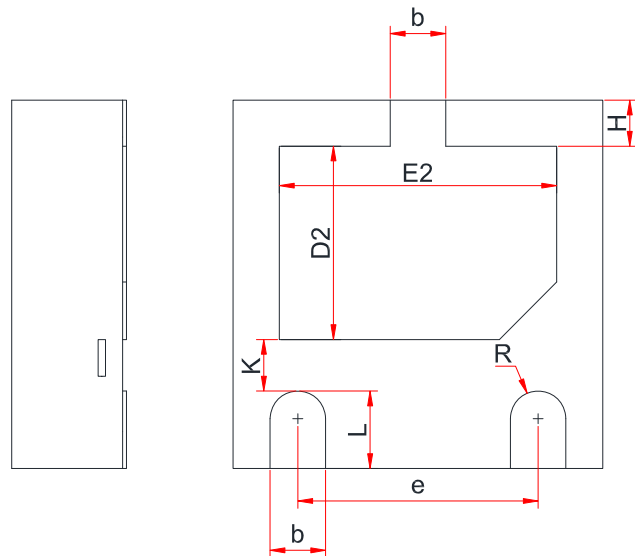
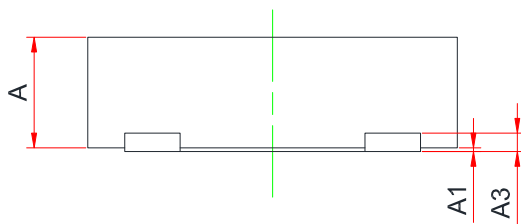
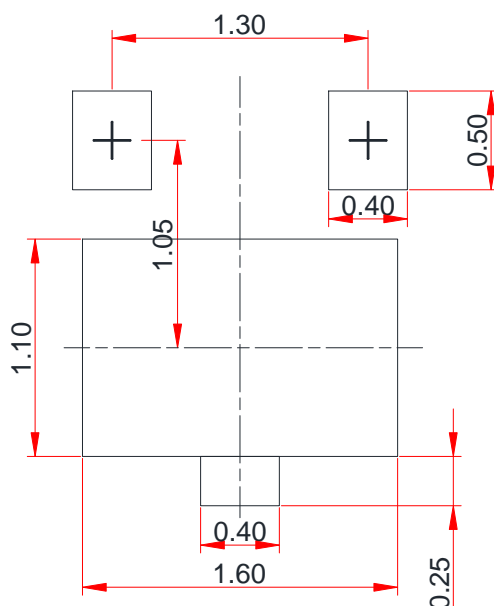
8/20 μs waveform per IEC61000-4-5

10/1000 μs waveform per IEC61643-321

Clamping voltage vs. Peak pulse current

Clamping voltage vs. Peak pulse current

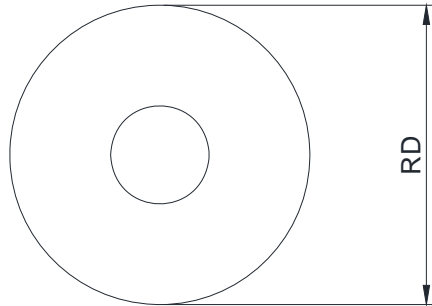
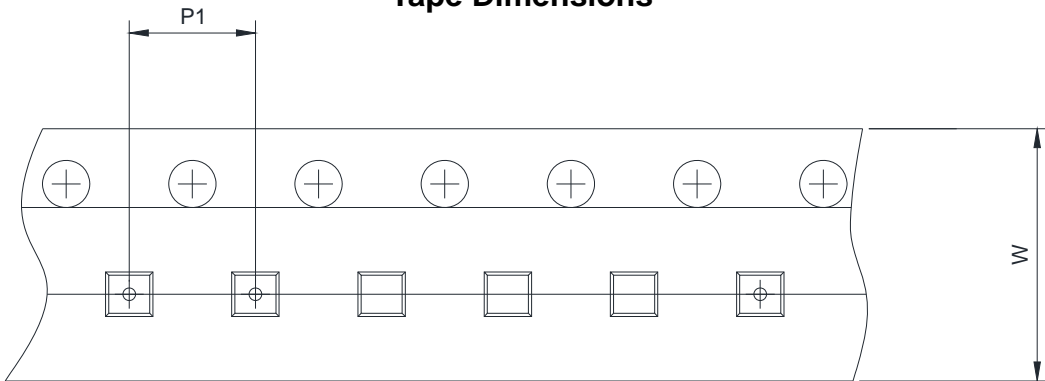
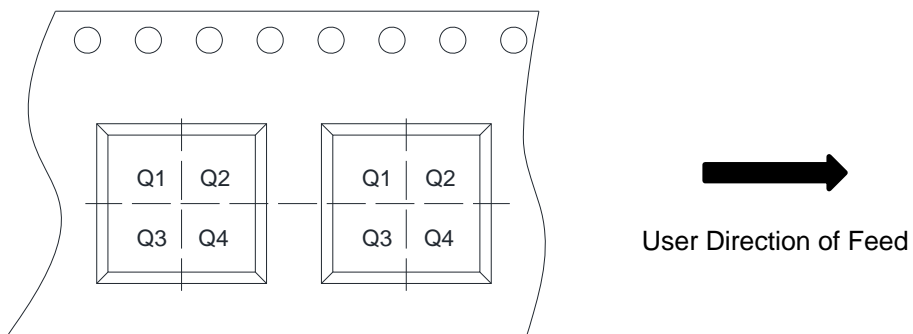
Non-repetitive peak pulse power vs. Pulse time

Power derating vs. Ambient temperature

Package outline dimensions
DFN2x2-3L

Top View

Bottom View

Side View
Recommended land pattern (Unit: mm)

Symbol	Dimensions In Millimeters		
	Min.	Typ.	Max.
A	0.50	0.58	0.65
A1	0.00	0.02	0.05
A3	0.10 REF.		
b	0.25	0.30	0.35
D	1.90	2.00	2.10
E	1.90	2.00	2.10
D2	0.95	1.05	1.15
E2	1.40	1.50	1.60
e	1.20	1.30	1.40
H	0.20	0.25	0.30
K	0.20	0.30	0.40
L	0.33	0.39	0.45
R	0.13	-	-

Notes:

This recommended land pattern is for reference purposes only. Please consult your manufacturing group to ensure your PCB design guidelines are met.

TAPE AND REEL INFORMATION
Reel Dimensions

Tape Dimensions

Quadrant Assignments For PIN1 Orientation In Tape

RD	Reel Dimension	<input checked="" type="checkbox"/> 7inch	<input type="checkbox"/> 13inch	
W	Overall width of the carrier tape	<input checked="" type="checkbox"/> 8mm	<input type="checkbox"/> 12mm	
P	Pitch between successive cavity centers	<input type="checkbox"/> 2mm	<input checked="" type="checkbox"/> 4mm	<input type="checkbox"/> 8mm
Pin1	Pin1 Quadrant	<input type="checkbox"/> Q1	<input checked="" type="checkbox"/> Q2	<input type="checkbox"/> Q3 <input type="checkbox"/> Q4

X-ON Electronics

Largest Supplier of Electrical and Electronic Components

Click to view similar products for [ESD Suppressors / TVS Diodes](#) category:

Click to view products by [Will Semiconductor](#) manufacturer:

Other Similar products are found below :

[60KS200C](#) [D18V0L1B2LP-7B](#) [D5V0F4U5P5-7](#) [DESD5V0U1BB-7](#) [NTE4902](#) [P4KE27CA](#) [P6KE11CA](#) [P6KE39CA-TP](#) [P6KE8.2A](#)
[SA110CA](#) [SA60CA](#) [SA64CA](#) [SMBJ12CATR](#) [SMBJ33CATR](#) [SMBJ8.0A](#) [ESD101-B1-02ELS E6327](#) [ESD105-B1-02EL E6327](#) [ESD112-B1-02EL E6327](#) [ESD119B1W01005E6327XTSA1](#) [ESD5V0L1B02VH6327XTSA1](#) [ESD7451N2T5G](#) [19180-510](#) [CPDT-5V0USP-HF](#)
[3.0SMCJ33CA-F](#) [3.0SMCJ36A-F](#) [HSPC16701B02TP](#) [D3V3Q1B2DLP3-7](#) [D55V0M1B2WS-7](#) [DESD5V0U1BL-7B](#) [DRTR5V0U4SL-7](#)
[SCM1293A-04SO](#) [ESD200-B1-CSP0201 E6327](#) [SM12-7](#) [SMF8.0A-TP](#) [SMLJ45CA-TP](#) [CEN955 W/DATA](#) [82350120560](#) [VESD12A1A-](#)
[HD1-GS08](#) [CPDUR5V0R-HF](#) [CPDQC5V0U-HF](#) [CPDQC5V0USP-HF](#) [CPDQC5V0-HF](#) [D1213A-01LP4-7B](#) [D1213A-02WL-7](#)
[MMAD1108/TR13](#) [5KP100A](#) [5KP15A](#) [5KP18A](#) [5KP48A](#) [5KP90A](#)