

ESD73111CZ

1-Line, Bi-directional, Ultra-low Capacitance Transient Voltage Suppressor

Descriptions

The ESD73111CZ is an ultra-low capacitance TVS (Transient Voltage Suppressor) designed to protect high speed data interfaces. It has been specifically designed to protect sensitive electronic components which are connected to data and transmission lines from over-stress caused by ESD (Electrostatic Discharge).

The ESD73111CZ incorporates one pair of ultra-low capacitance diodes.

The ESD73111CZ may be used to provide ESD protection up to $\pm 10\text{kV}$ (contact discharge) according to IEC61000-4-2, and withstand peak pulse current up to 6A (8/20 μs) according to IEC61000-4-5.

The ESD73111CZ is available in DWN0603-2L package. Standard products are Pb-free and Halogen-free.

Features

- Stand-off voltage: $\pm 5.0\text{V}$ Max.
- Transient protection for each line according to IEC61000-4-2 (ESD): $\pm 10\text{kV}$ (contact discharge)
: $\pm 15\text{kV}$ (air discharge)
IEC61000-4-5 (surge): 6A (8/20 μs)
- Low capacitance: $C_J = 0.15\text{pF}$ typ.
- Low leakage current
- Low clamping voltage: $V_{CL} = 8.0\text{V}$ typ. @ $I_{PP} = 16\text{A}$ (TLP)
- Solid-state silicon technology

Applications

- USB 3.0 and USB3.1
- HDMI 1.4 and HDMI 2.0
- Thunderbolt
- Cellular handsets

<http://www.omnivision-group.com>

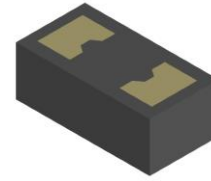

DWN0603-2L (Bottom View)

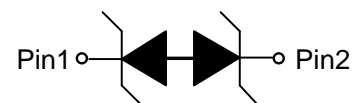

Pin configuration

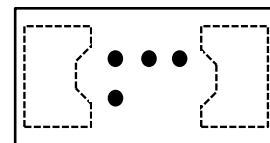

●●● Device code

Marking (Top View)

Order information

Device	Package	Shipping
ESD73111CZ-2/TR	DWN0603-2L	10000/Tape&Reel

Absolute maximum ratings

Parameter	Symbol	Rating	Unit
Peak pulse power ($t_p = 8/20\mu s$)	P_{pk}	30	W
Peak pulse current ($t_p = 8/20\mu s$)	I_{PP}	6	A
ESD according to IEC61000-4-2 air discharge	V_{ESD}	± 15	kV
ESD according to IEC61000-4-2 contact discharge		± 10	
Junction temperature	T_J	125	$^{\circ}C$
Operating temperature	T_{OP}	-40~85	$^{\circ}C$
Lead temperature	T_L	260	$^{\circ}C$
Storage temperature	T_{STG}	-55~150	$^{\circ}C$

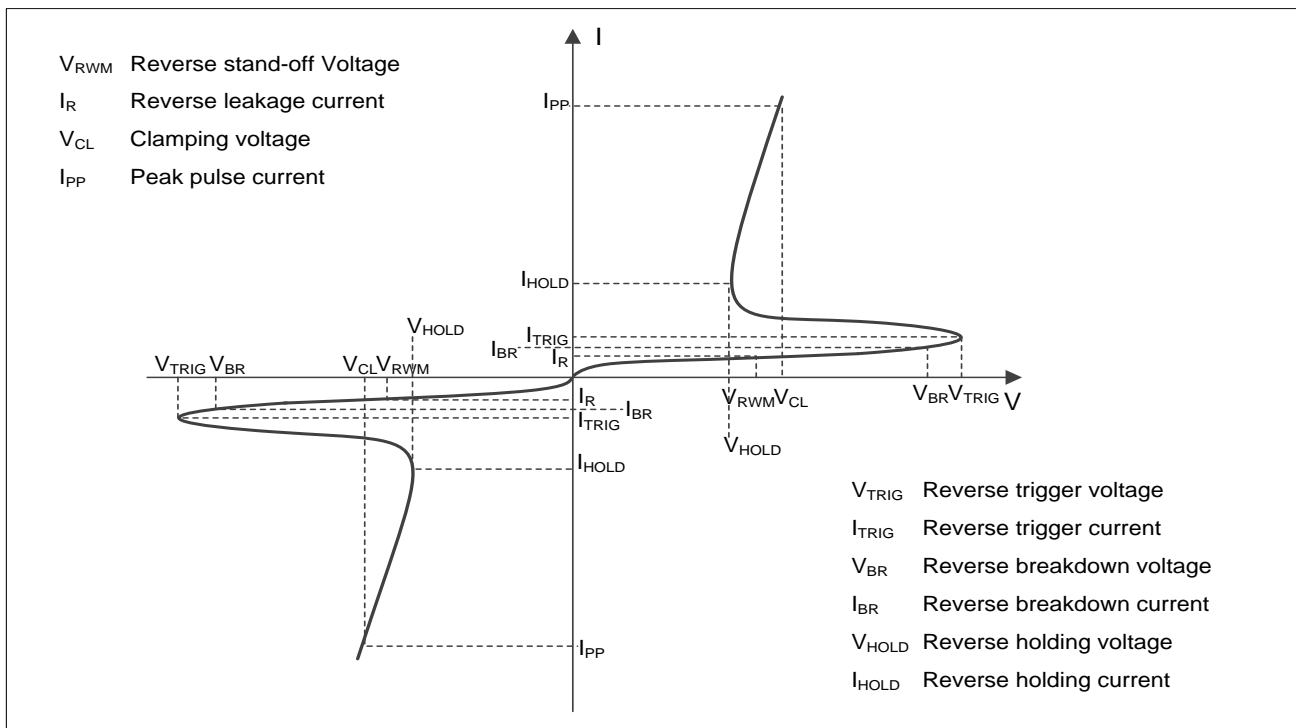
Electrical characteristics ($T_A=25^{\circ}C$, unless otherwise noted)

Definitions of electrical characteristics

Electrical characteristics (T_A=25 °C, unless otherwise noted)

Parameter	Symbol	Condition	Min.	Typ.	Max.	Unit
Reverse maximum working voltage	V _{RWM}				±5.0	V
Reverse leakage current	I _R	V _{RWM} = 5.0V			1.0	μA
Reverse breakdown voltage	V _{BR}	I _T = 1mA	9.5	11	12.5	V
Clamping voltage ¹⁾	V _{CL}	I _{PP} = 16A, t _p = 100ns		8.0		V
Dynamic resistance ¹⁾	R _{DYN}			0.34		Ω
Clamping voltage ²⁾	V _{CL}	V _{ESD} = 8kV		8.0		V
Clamping voltage ³⁾	V _{CL}	I _{PP} = 1A, t _p = 8/20μs		3.0	3.5	V
		I _{PP} = 6A, t _p = 8/20μs		5.5	6.5	V
Junction capacitance	C _J	V _R = 1.5V, f = 1MHz		0.15	0.20	pF

Notes:

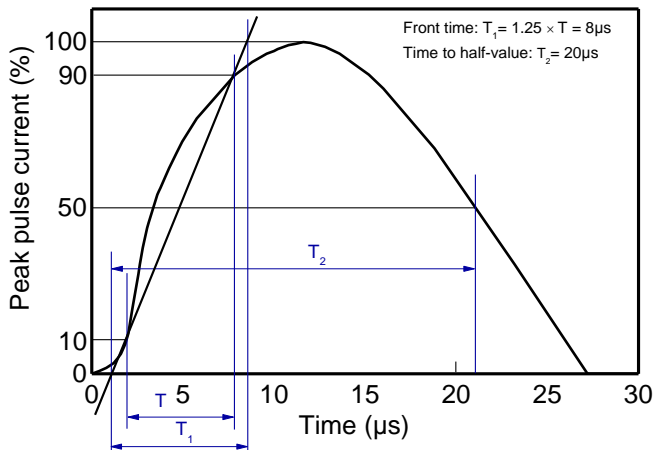
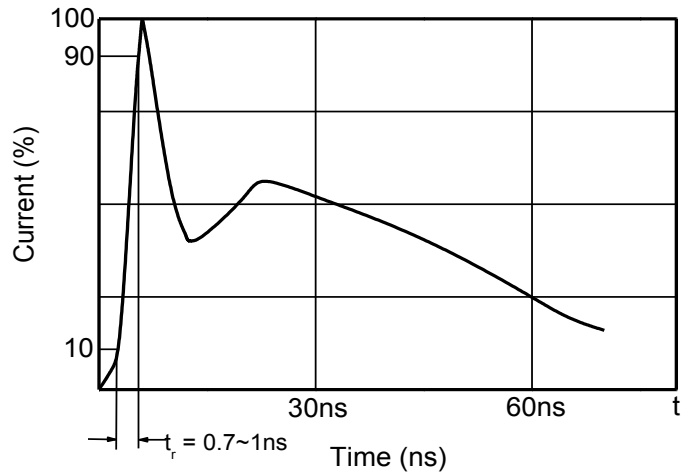
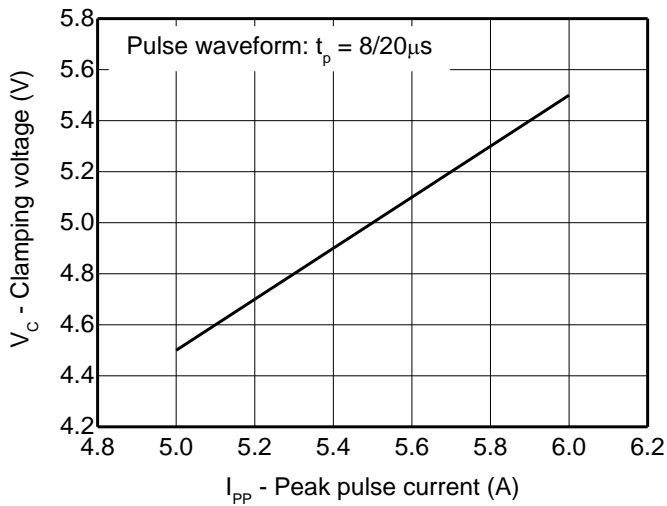
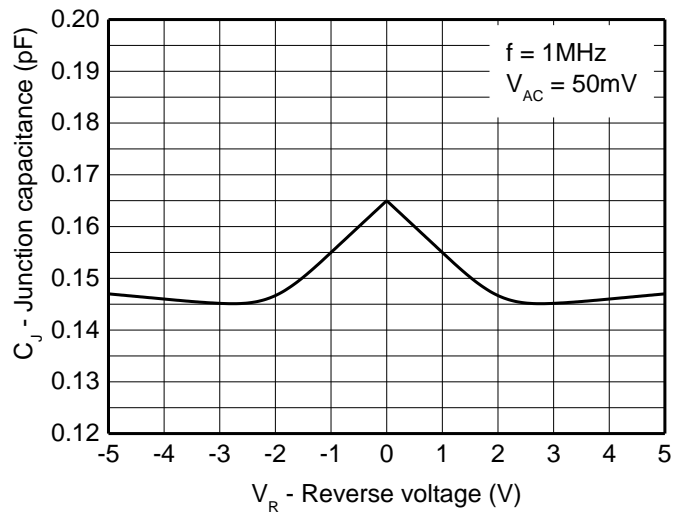
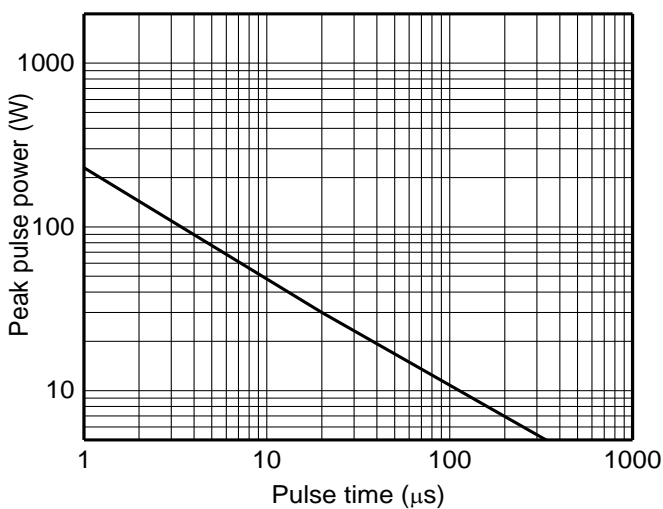
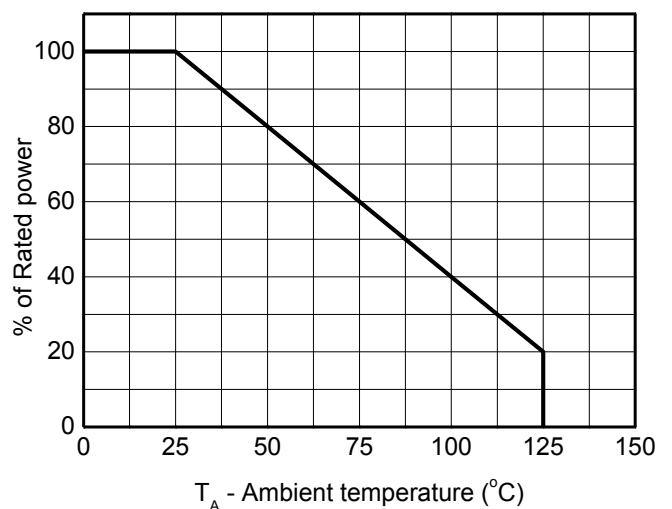
- 1) TLP parameter: Z₀ = 50Ω, t_p = 100ns, t_r = 2ns, averaging window from 60ns to 80ns. R_{DYN} is calculated from 4A to 16A.
- 2) Contact discharge mode, according to IEC61000-4-2.
- 3) Non-repetitive current pulse, according to IEC61000-4-5.

Typical characteristics ($T_A=25^\circ\text{C}$, unless otherwise noted)

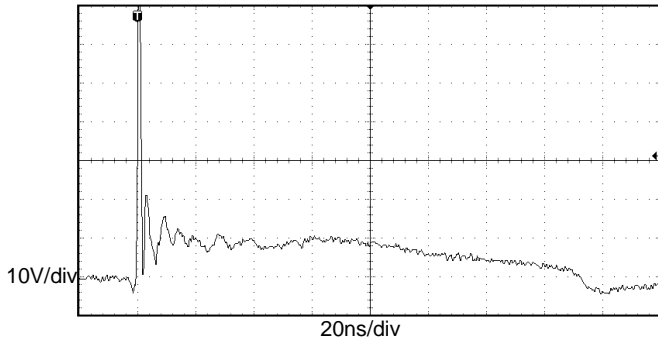
8/20μs waveform per IEC61000-4-5

Contact discharge current waveform per IEC61000-4-2

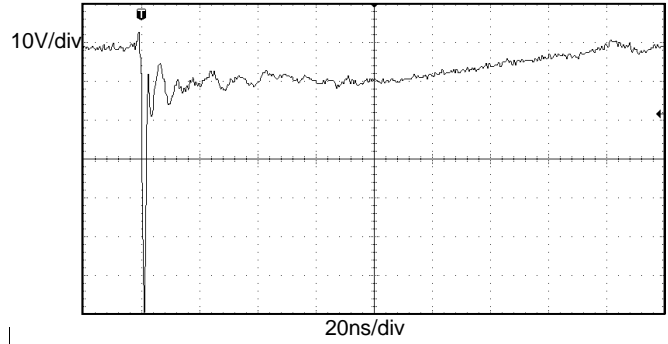
Clamping voltage vs. Peak pulse current

Capacitance vs. Reverse voltage

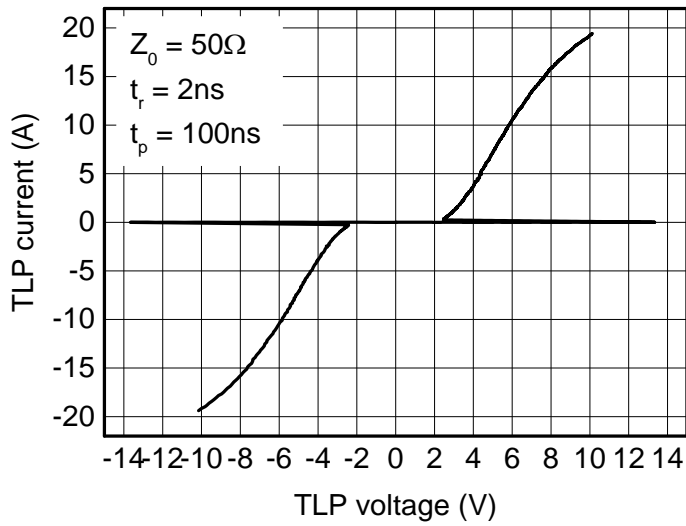
Non-repetitive peak pulse power vs. Pulse time

Power derating vs. Ambient temperature

Typical characteristics ($T_A = 25^\circ\text{C}$, unless otherwise noted)

ESD clamping
 (+8kV contact discharge per IEC61000-4-2)



ESD clamping
 (-8kV contact discharge per IEC61000-4-2)

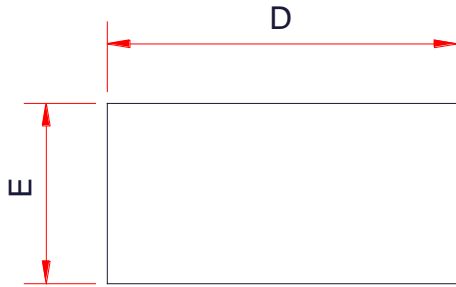
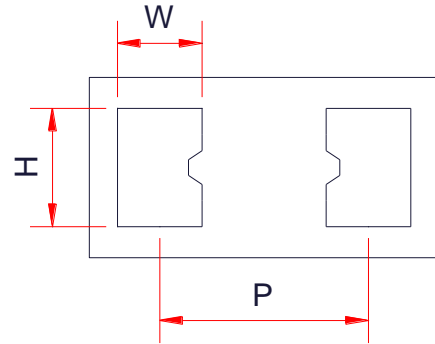
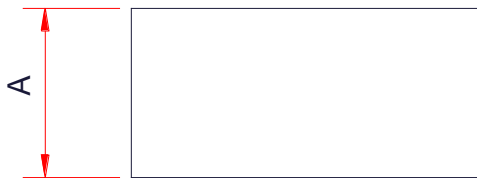

TLP Measurement

PACKAGE OUTLINE DIMENSIONS
DWN0603-2L

TOP VIEW

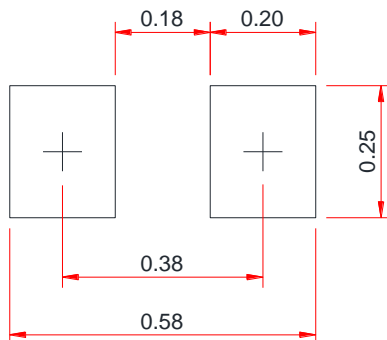
BOTTOM VIEW

SIDE VIEW

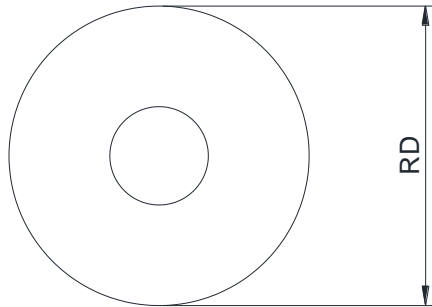
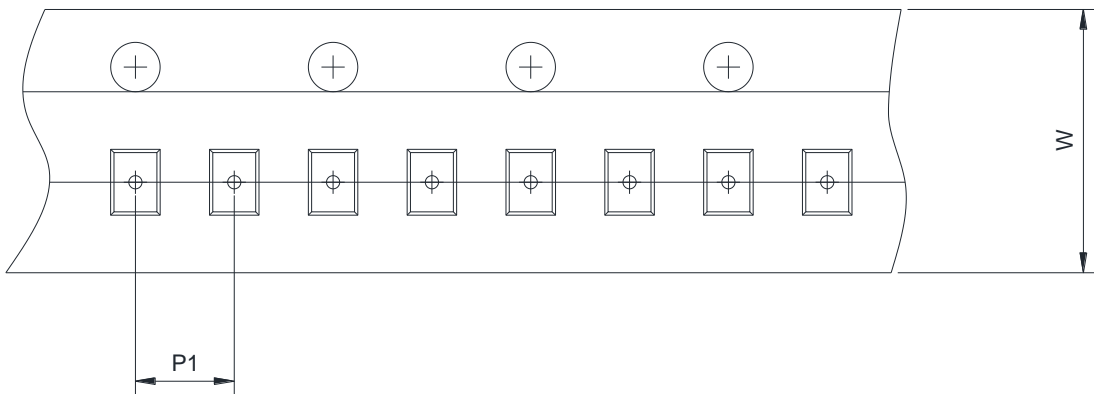
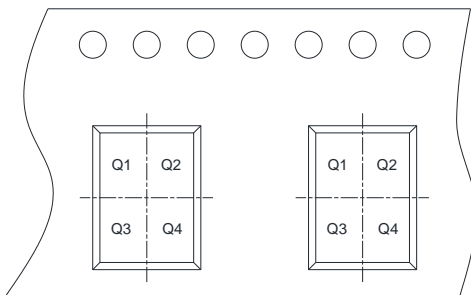
Symbol	Dimensions in Millimeters		
	Min.	Typ.	Max.
A	0.29	0.31	0.34
E	0.29	0.32	0.35
D	0.59	0.62	0.65
W	0.15Ref		
H	0.21Ref		
P	0.38Ref		

Recommend land pattern (Unit: mm)

Notes:

This recommended land pattern is for reference purposes only. Please consult your manufacturing group to ensure your PCB design guidelines are met.

TAPE AND REEL INFORMATION
Reel Dimensions

Tape Dimensions

Quadrant Assignments For PIN1 Orientation In Tape



 User Direction of Feed

RD	Reel Dimension	<input checked="" type="checkbox"/> 7inch	<input type="checkbox"/> 13inch
W	Overall width of the carrier tape	<input checked="" type="checkbox"/> 8mm	<input type="checkbox"/> 12mm <input type="checkbox"/> 16mm
P1	Pitch between successive cavity centers	<input checked="" type="checkbox"/> 2mm	<input type="checkbox"/> 4mm <input type="checkbox"/> 8mm
Pin1	Pin1 Quadrant	<input checked="" type="checkbox"/> Q1	<input checked="" type="checkbox"/> Q2 <input type="checkbox"/> Q3 <input type="checkbox"/> Q4

X-ON Electronics

Largest Supplier of Electrical and Electronic Components

Click to view similar products for [ESD Suppressors / TVS Diodes](#) category:

Click to view products by [Will Semiconductor](#) manufacturer:

Other Similar products are found below :

[60KS200C](#) [D18V0L1B2LP-7B](#) [D5V0F4U5P5-7](#) [NTE4902](#) [P4KE27CA](#) [P6KE11CA](#) [P6KE39CA-TP](#) [P6KE8.2A](#) [JANTX1N6053A](#)
[SA110CA](#) [SA60CA](#) [SA64CA](#) [SMBJ12CATR](#) [SMBJ33CATR](#) [SMBJ8.0A](#) [ESD101-B1-02ELS E6327](#) [ESD105-B1-02EL E6327](#) [ESD112-B1-02EL E6327](#) [ESD119B1W01005E6327XTSA1](#) [ESD5V0L1B02VH6327XTSA1](#) [ESD7451N2T5G](#) [19180-510](#) [CPDT-5V0USP-HF](#)
[3.0SMCJ33CA-F](#) [3.0SMCJ36A-F](#) [HSPC16701B02TP](#) [JANTX1N6126A](#) [JANTX1N6462](#) [JANTX1N6465](#) [USB50805e3/TR7](#)
[D3V3Q1B2DLP3-7](#) [D55V0M1B2WS-7](#) [DRTR5V0U4SL-7](#) [SCM1293A-04SO](#) [ESD200-B1-CSP0201 E6327](#) [SM12-7](#) [SM1605E3/TR13](#)
[SMLJ45CA-TP](#) [CEN955 W/DATA](#) [82350120560](#) [VESD12A1A-HD1-GS08](#) [CPDUR5V0R-HF](#) [CPDQC5V0U-HF](#) [CPDQC5V0USP-HF](#)
[CPDQC5V0-HF](#) [D1213A-01LP4-7B](#) [ESD101-B1-02EL E6327](#) [824500181](#) [MMAD1108/TR13](#) [5KP100A](#)