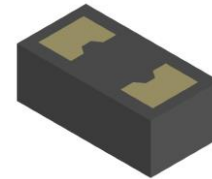

**ESD73311CZ**

**1-Line, Bi-directional, Ultra-low Capacitance Transient Voltage Suppressor**

<http://www.sh-willsemi.com>

**Descriptions**

**DWN0603-2L (Bottom View)**

The ESD73311CZ is an ultra-low capacitance TVS (Transient Voltage Suppressor) designed to protect high speed data interfaces. It has been specifically designed to protect sensitive electronic components which are connected to data and transmission lines from over-stress caused by ESD (Electrostatic Discharge).

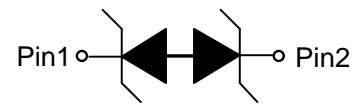

The ESD73311CZ may be used to provide ESD protection up to  $\pm 30\text{kV}$  (contact discharge) according to IEC61000-4-2, and withstand peak pulse current up to 20A (8/20 $\mu\text{s}$ ) according to IEC61000-4-5.

**Pin configuration**

The ESD73111CZ is available in DWN0603-2L package. Standard products are Pb-free and Halogen-free.

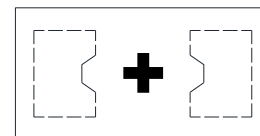

Device code

**+ Marking (Top View)**

**Features**
**Order information**

- Stand-off voltage:  $\pm 3.3\text{V}$  Max.
- Transient protection for each line according to IEC61000-4-2 (ESD):  $\pm 30\text{kV}$  (contact discharge)  
:  $\pm 30\text{kV}$  (air discharge)  
IEC61000-4-5 (surge): 20A (8/20 $\mu\text{s}$ )
- Low capacitance:  $C_J = 0.40\text{pF}$  typ.
- Low leakage current
- Low clamping voltage:  $V_{CL} = 4.5\text{V}$  typ. @  $I_{PP} = 16\text{A}$  (TLP)
- Solid-state silicon technology

Device	Package	Shipping
ESD73311CZ-2/TR	DWN0603-2L	10000/Tape&Reel

**Applications**

- High-speed interfaces
- USB 2.0 and USB 3.2
- Cellular handsets and accessories
- Portable Electronics and Notebooks
- TVs and monitors

**Absolute maximum ratings**

Parameter	Symbol	Rating	Unit
Peak pulse power ( $t_p = 8/20\mu s$ )	$P_{pk}$	130	W
Peak pulse current ( $t_p = 8/20\mu s$ )	$I_{PP}$	20	A
ESD according to IEC61000-4-2 air discharge	$V_{ESD}$	$\pm 30$	kV
ESD according to IEC61000-4-2 contact discharge		$\pm 30$	
Junction temperature	$T_J$	125	$^{\circ}C$
Operating temperature	$T_{OP}$	-40~85	$^{\circ}C$
Lead temperature	$T_L$	260	$^{\circ}C$
Storage temperature	$T_{STG}$	-55~150	$^{\circ}C$

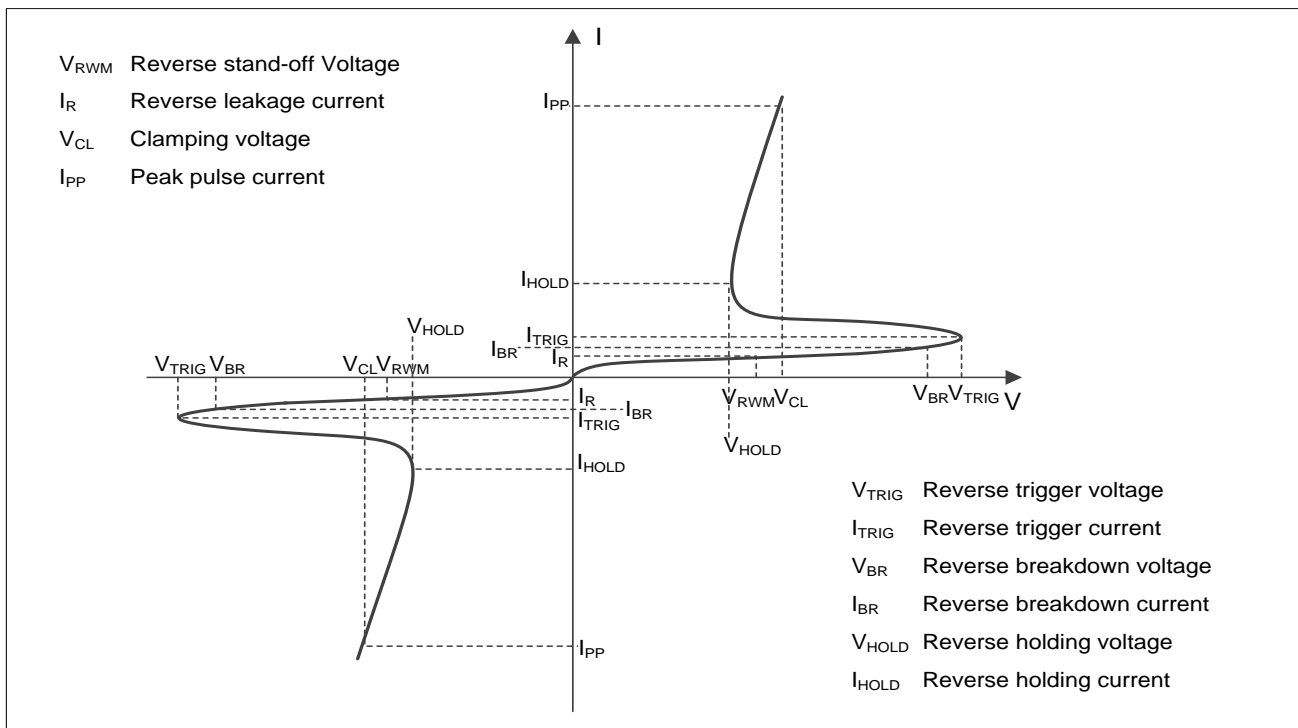
**Electrical characteristics ( $T_A=25^{\circ}C$ , unless otherwise noted)**

**Definitions of electrical characteristics**

**Electrical characteristics ( $T_A=25\text{ }^\circ\text{C}$ , unless otherwise noted)**

Parameter	Symbol	Condition	Min.	Typ.	Max.	Unit
Reverse maximum working voltage	$V_{RWM}$				$\pm 3.3$	V
Reverse leakage current	$I_R$	$V_{RWM} = 3.3V$			100	nA
Reverse breakdown voltage	$V_{BR}$	$I_T = 1mA$	6.0	7.0	8.0	V
Clamping voltage <sup>1)</sup>	$V_{CL}$	$I_{PP} = 16A, t_p = 100ns$		4.5		V
Dynamic resistance <sup>1)</sup>	$R_{DYN}$			0.12		$\Omega$
Clamping voltage <sup>2)</sup>	$V_{CL}$	$V_{ESD} = 8kV$		5.4		V
Clamping voltage <sup>3)</sup>	$V_{CL}$	$I_{PP} = 1A, t_p = 8/20\mu s$		2.5	3.5	V
		$I_{PP} = 20A, t_p = 8/20\mu s$		5.5	6.5	V
Junction capacitance	$C_J$	$V_R = 1.5V, f = 1MHz$		0.40	0.60	pF

*Notes:*

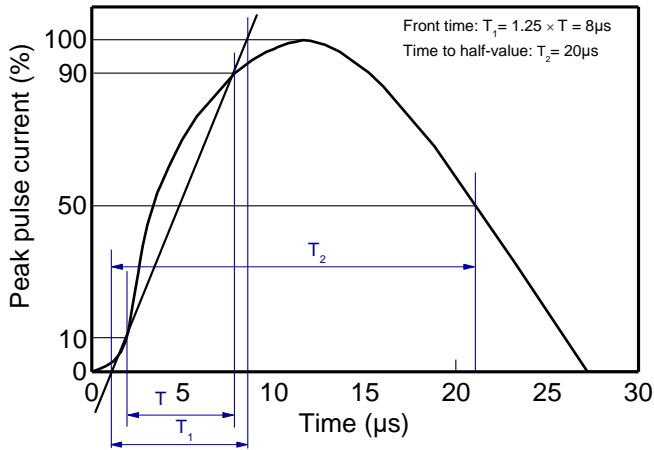
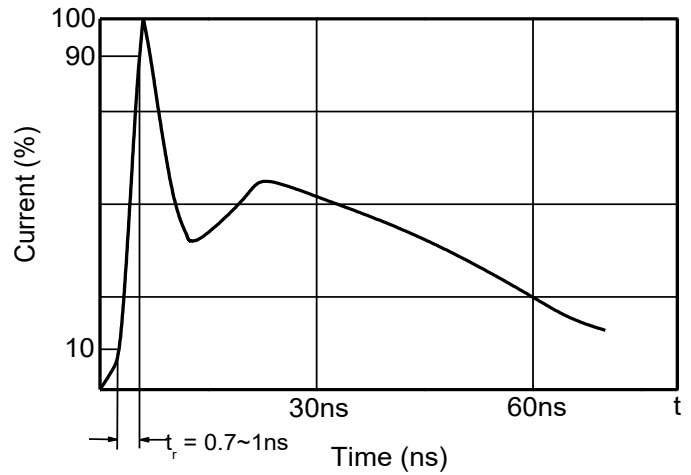
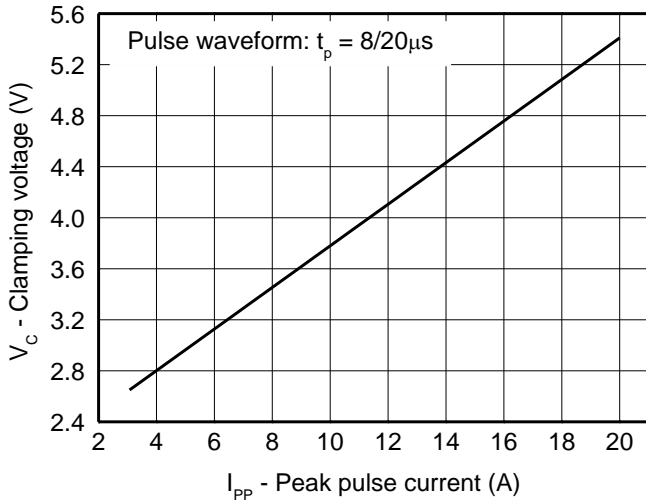
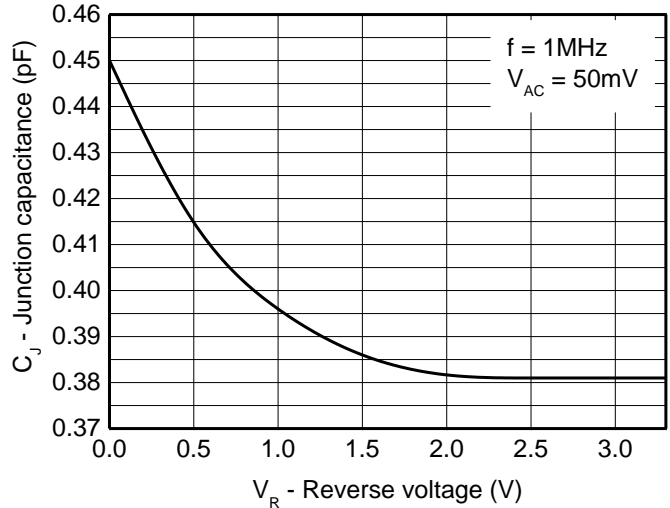
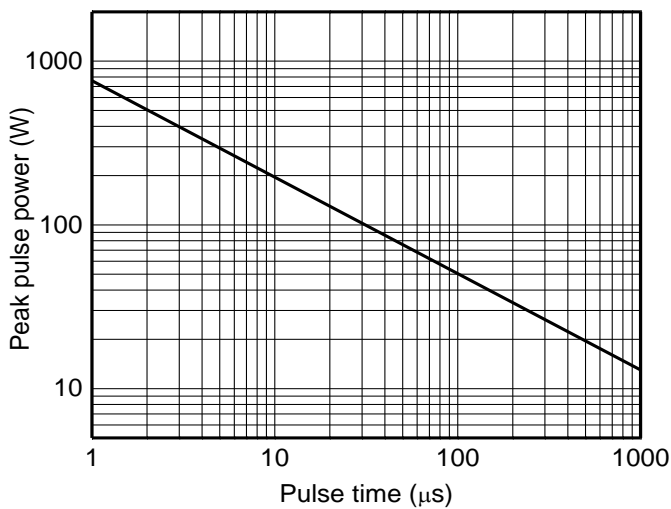
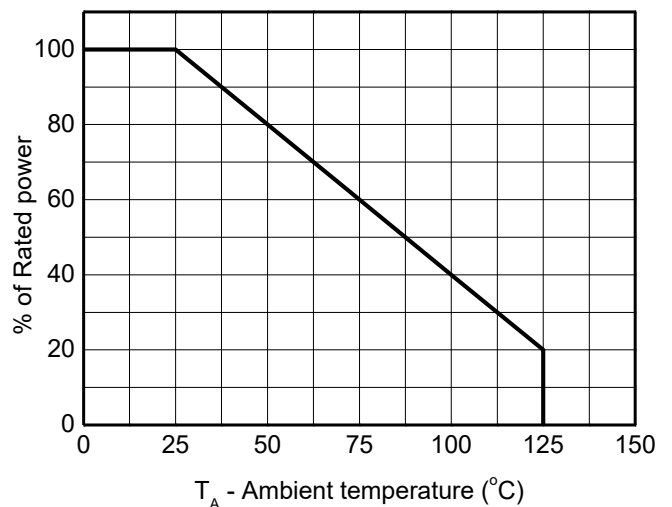
- 1) TLP parameter:  $Z_0 = 50\Omega, t_p = 100ns, t_r = 2ns$ , averaging window from 60ns to 80ns.  $R_{DYN}$  is calculated from 4A to 16A.
- 2) Contact discharge mode, according to IEC61000-4-2.
- 3) Non-repetitive current pulse, according to IEC61000-4-5.

**Typical characteristics ( $T_A=25^\circ\text{C}$ , unless otherwise noted)**

**8/20μs waveform per IEC61000-4-5**

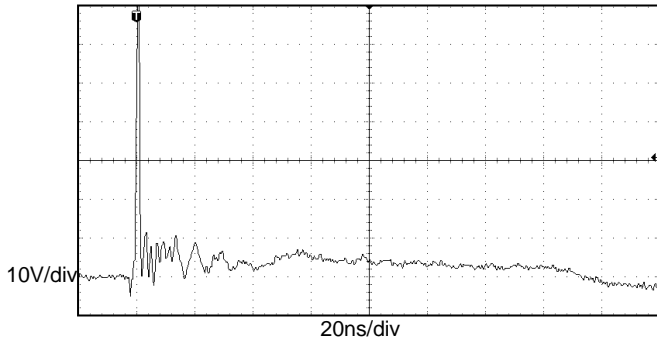
**Contact discharge current waveform per IEC61000-4-2**

**Clamping voltage vs. Peak pulse current**

**Capacitance vs. Reverse voltage**

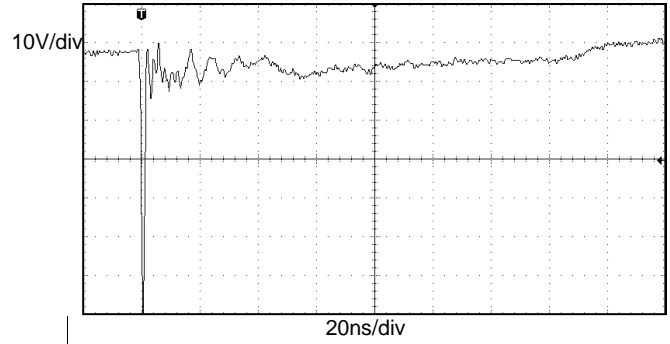
**Non-repetitive peak pulse power vs. Pulse time**

**Power derating vs. Ambient temperature**

Typical characteristics ( $T_A = 25^\circ\text{C}$ , unless otherwise noted)



**ESD clamping**

(+8kV contact discharge per IEC61000-4-2)



**ESD clamping**

(-8kV contact discharge per IEC61000-4-2)

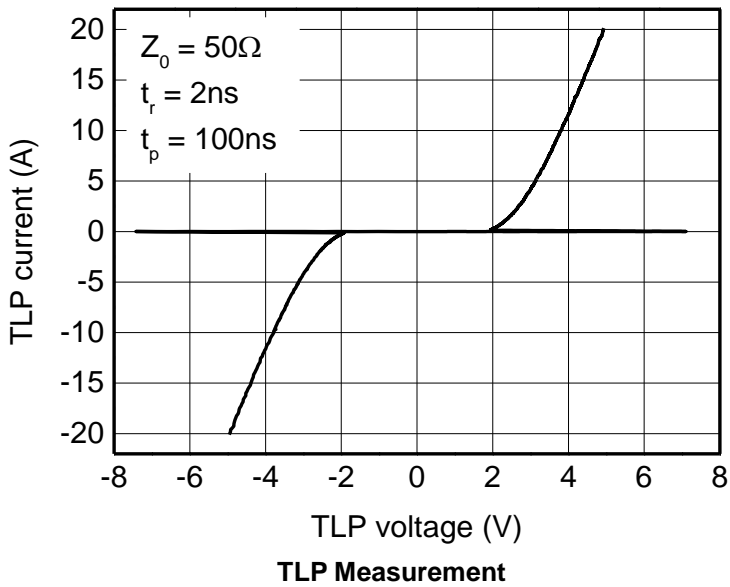

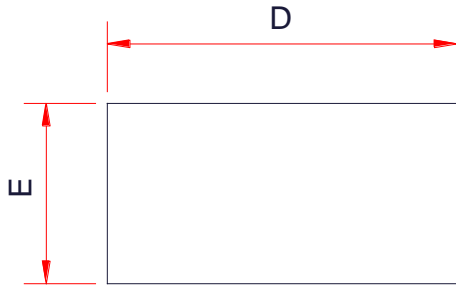
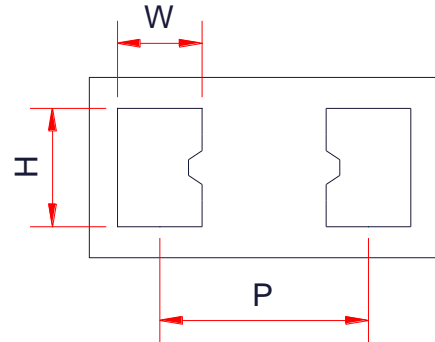
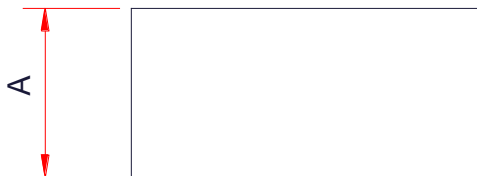
**PACKAGE OUTLINE DIMENSIONS**
**DWN0603-2L**

**TOP VIEW**

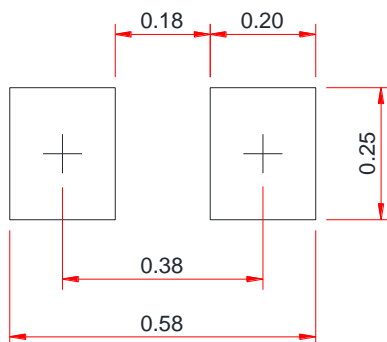
**BOTTOM VIEW**

**SIDE VIEW**

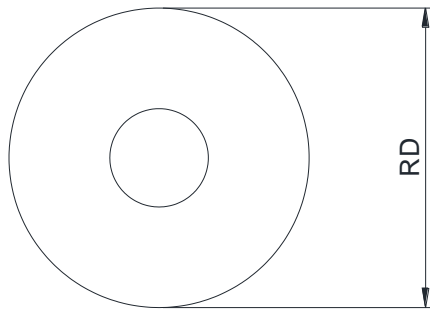
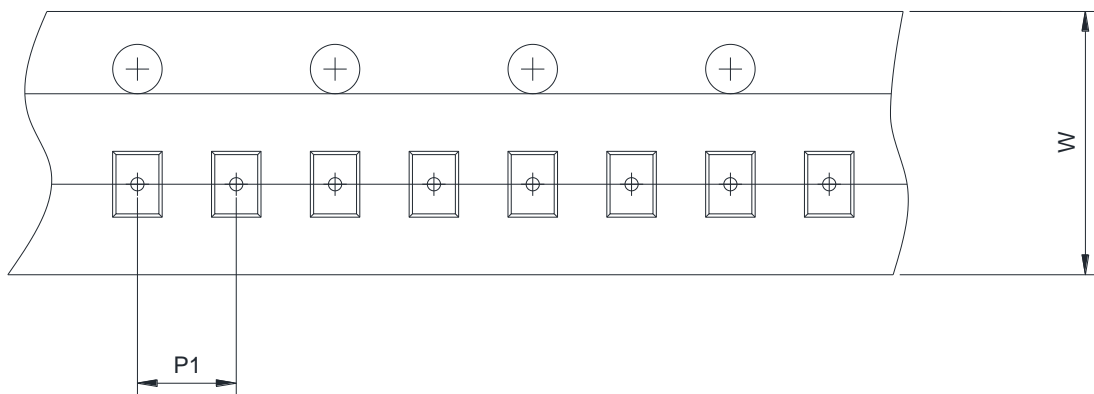
Symbol	Dimensions in Millimeters		
	Min.	Typ.	Max.
A	0.29	0.31	0.34
E	0.29	0.32	0.35
D	0.59	0.62	0.65
W	0.15Ref		
H	0.21Ref		
P	0.38Ref		

**Recommend land pattern (Unit: mm)**

**Notes:**

This recommended land pattern is for reference purposes only. Please consult your manufacturing group to ensure your PCB design guidelines are met.

**TAPE AND REEL INFORMATION**
**Reel Dimensions**

**Tape Dimensions**

RD	Reel Dimension	<input checked="" type="checkbox"/> 7inch	<input type="checkbox"/> 13inch
W	Overall width of the carrier tape	<input checked="" type="checkbox"/> 8mm	<input type="checkbox"/> 12mm
P1	Pitch between successive cavity centers	<input checked="" type="checkbox"/> 2mm	<input type="checkbox"/> 4mm <input type="checkbox"/> 8mm

## X-ON Electronics

Largest Supplier of Electrical and Electronic Components

*Click to view similar products for [ESD Suppressors / TVS Diodes](#) category:*

*Click to view products by [Will Semiconductor](#) manufacturer:*

Other Similar products are found below :

[60KS200C](#) [D18V0L1B2LP-7B](#) [D5V0F4U5P5-7](#) [NTE4902](#) [P4KE27CA](#) [P6KE11CA](#) [P6KE8.2A](#) [SA60CA](#) [SA64CA](#) [SMBJ12CATR](#)  
[SMBJ33CATR](#) [SMBJ6.5A](#) [SMBJ8.0A](#) [ESD101-B1-02ELS](#) [E6327](#) [ESD112-B1-02EL](#) [E6327](#) [ESD7451N2T5G](#) [19180-510](#) [CPDT-5V0USP-](#)  
[HF](#) [3.0SMCJ33CA-F](#) [3.0SMCJ36A-F](#) [HSPC16701B02TP](#) [JANTX1N6126A](#) [D3V3Q1B2DLP3-7](#) [D55V0M1B2WS-7](#) [SCM1293A-04SO](#)  
[ESD200-B1-CSP0201](#) [E6327](#) [SM12-7](#) [CEN955](#) [W/DATA](#) [VESD12A1A-HD1-GS08](#) [CPDQC5V0-HF](#) [D1213A-01LP4-7B](#) [ESD101-B1-02EL](#)  
[E6327](#) [AOZ8808DI-03](#) [5KP15A](#) [5KP48A](#) [5KP90A](#) [ESD3V3D7-TP](#) [15KPA36A-LF](#) [P4KE56CA](#) [P4KE68A](#) [P4KE91CATR](#) [P6KE120A](#)  
[P6KE13CA](#) [P6KE43CA](#) [P6KE6.8CA](#) [P6KE8.2](#) [P6SMBJ20CA](#) [JANTX1N6072A](#) [SR2835ESKG](#) [SA90CA](#)