

# WL2801E

Low noise, High PSRR, High speed, CMOS LDO

[Http://www.willsemi.com](http://www.willsemi.com)

## Descriptions

The WL2801E series is a high accuracy, low noise, high speed, low dropout CMOS Linear regulator with high ripple rejection. The devices offer a new level of cost effective performance in cellular phones, laptop and notebook computers, and other portable devices.

The current limiter's fold-back circuit also operates as a short circuit protection and an output current limiter at the output pin.

The WL2801E regulators are available in standard SOT-23-5L packages. Standard products are Pb-free and Halogen-free.



SOT-23-5L

## Features

- Input voltage : 2.7V~5.5V
- Output range : 1.2V~3.3V
- Output current : 200mA (@Vout<2V)( Typ.)
- : 300mA (@Vout>2V)( Typ.)
- PSRR : 75dB @ 217Hz
- Dropout voltage : 170mV @ I<sub>OUT</sub>=200mA
- Quiescent current : 70μA Typ.
- Shut-down current : < 0.1μA
- Recommend capacitor : 1uF

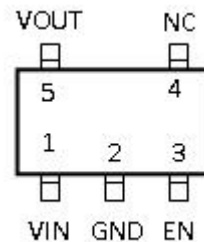

Pin Configuration (Top View)

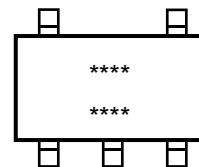

For detail marking information, please see page 10.

### Marking

## Applications

- MP3/MP4 Players
- Cellphones, radiophone, digital cameras
- Bluetooth, wireless handsets
- Others portable electronics device

## Order Information

For detail order information, please see page 10.

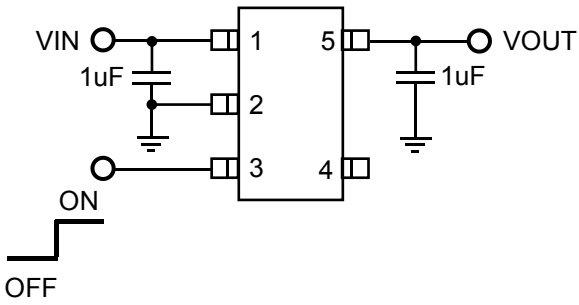
**Typical Application**

**Pin Description**

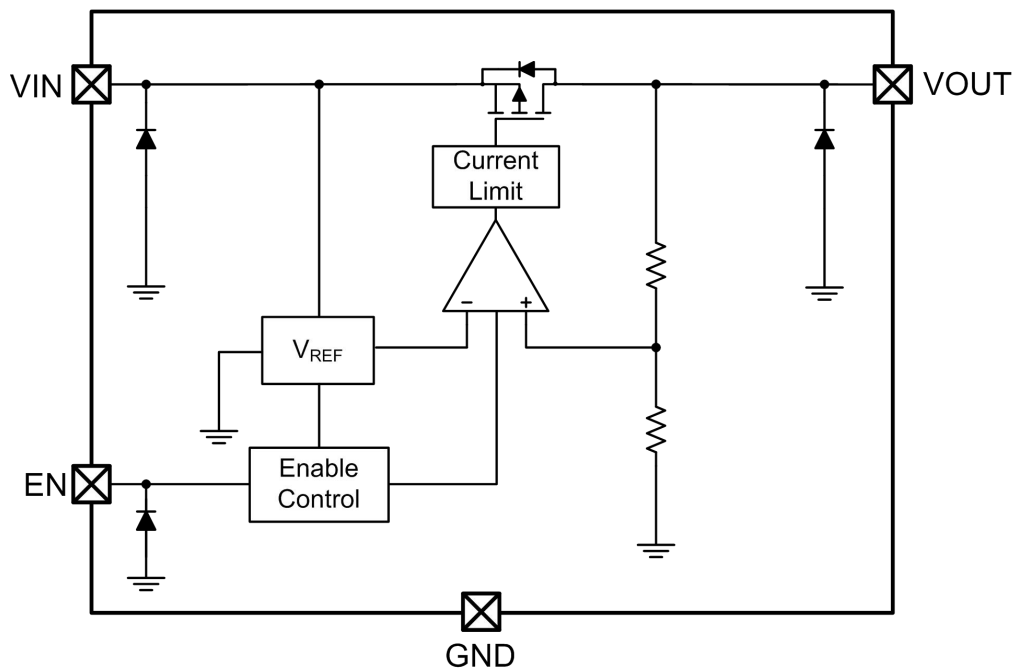
PIN	Symbol	Description
1	VIN	Input
2	GND	Ground
3	EN	Enable (Active high)
4	NC	Not connected
5	VOUT	Output

**Block Diagram**

**Absolute Maximum Ratings**

Parameter	Value	Unit
Power Dissipation	Internal limited	mW
V <sub>IN</sub> Range	-0.3~6.5	V
V <sub>EN</sub> Range	-0.3~V <sub>IN</sub>	V
V <sub>OUT</sub> Range	-0.3~V <sub>IN</sub>	V
Lead Temperature Range	260	°C
Storage Temperature Range	-55 ~ 150	°C
Operating Junction Temperature Range	150	°C

**Recommend Operating Ratings**

Parameter	Value	Unit
Operating Supply voltage	2.7~5.5	V
Operating Temperature Range	-40~85	°C
Thermal Resistance, R <sub>θJA</sub>	250	°C/W
Theta-JC	70	°C/W
Theta-JA	250	°C/W

**Electronics Characteristics (Ta=25°C, V<sub>IN</sub>=V<sub>OUT</sub>+1V, C<sub>IN</sub>=C<sub>OUT</sub>=1uF, unless otherwise noted)**

Parameter	Symbol	Condition	Min.	Typ.	Max.	Unit
Output Voltage	V <sub>OUT</sub>	V <sub>OUT</sub> < 2V, V <sub>IN</sub> =2.7V, I <sub>OUT</sub> =1mA	0.97 V <sub>OUT</sub>	V <sub>OUT</sub>	1.03 V <sub>OUT</sub>	V
		V <sub>OUT</sub> ≥ 2V, I <sub>OUT</sub> =1mA	0.98 V <sub>OUT</sub>	V <sub>OUT</sub>	1.02 V <sub>OUT</sub>	
Current Limit	I <sub>LIM</sub>	V <sub>EN</sub> =V <sub>IN</sub>	Ref. to Output Voltage vs. Output Current Chart			mA
Dropout Voltage	V <sub>DROP</sub>	V <sub>OUT</sub> =2.8V, I <sub>OUT</sub> =200mA		170	200	mV
		V <sub>OUT</sub> =2.8V, I <sub>OUT</sub> =300mA		250	300	
Line Regulation	ΔV <sub>LINE</sub>	V <sub>IN</sub> =2.7~5.5V, I <sub>OUT</sub> =1mA		0.01	0.15	%/V
Load Regulation	ΔV <sub>Load</sub>	V <sub>OUT</sub> =2.8V, I <sub>OUT</sub> =1~300mA		20	30	mV
Quiescent Current	I <sub>Q</sub>	V <sub>OUT</sub> =2.8V, I <sub>OUT</sub> =0		70	100	μA
Short Current	I <sub>SHORT</sub>	V <sub>EN</sub> =V <sub>IN</sub> , V <sub>OUT</sub> Short to GND with 1Ω		170		mA
Shut-down Current	I <sub>SHDN</sub>	V <sub>EN</sub> =0V		0.1	1.0	μA
Power Supply Rejection Rate	PSRR	V <sub>IN</sub> =(V <sub>OUT</sub> +1V) <sub>DC</sub> +0.5V <sub>P-P</sub> F=217Hz, I <sub>OUT</sub> =10mA		75		dB
		V <sub>IN</sub> =(V <sub>OUT</sub> +1V) <sub>DC</sub> +0.5V <sub>P-P</sub> F=10KHz, I <sub>OUT</sub> =10mA		65		
EN logic high voltage	V <sub>ENH</sub>	V <sub>IN</sub> =5.5V, I <sub>OUT</sub> =1mA	1.2			V
EN logic low voltage	V <sub>ENL</sub>	V <sub>IN</sub> =5.5V, V <sub>OUT</sub> =0V			0.4	V
EN Input Current	I <sub>EN</sub>	V <sub>EN</sub> = 0 to 5.5V			1.0	μA
Output Noise Voltage	e <sub>NO</sub>	10Hz to 100KHz, C <sub>OUT</sub> =1μF		100		μV <sub>RMS</sub>

Typical characteristics ( $T_a=25^\circ\text{C}$ ,  $V_{IN}=V_{OUT}+1\text{V}$ ,  $C_{IN}=C_{OUT}=1\mu\text{F}$ , unless otherwise noted)

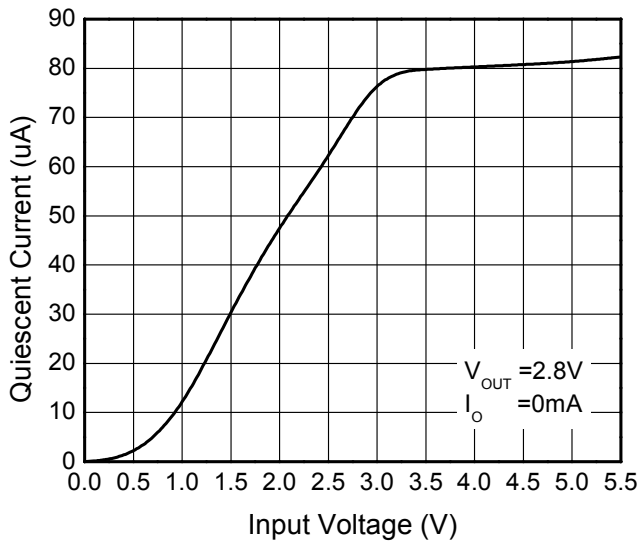

**Quiescent current vs. Supply voltage**

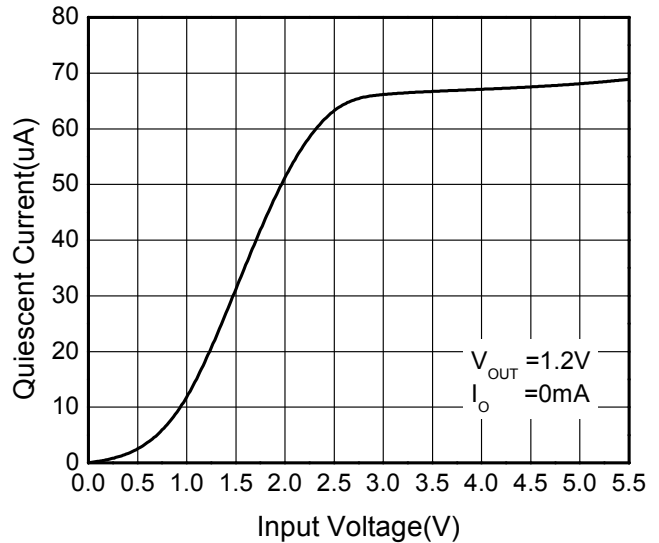

**Quiescent current vs. Supply voltage**

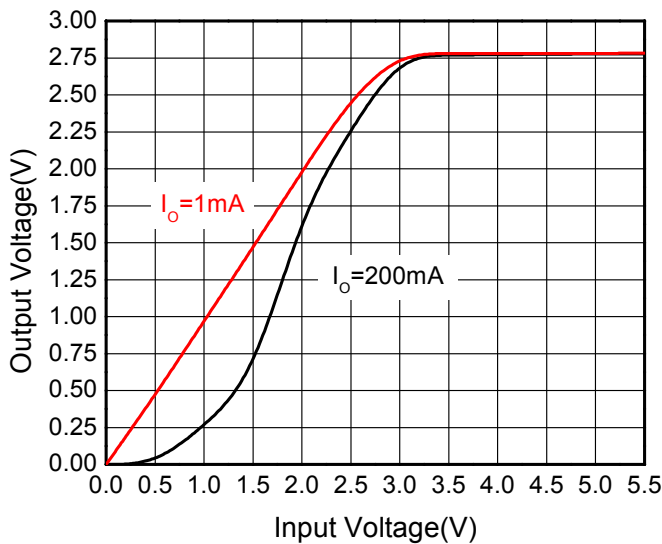

**Output voltage vs. Supply voltage**

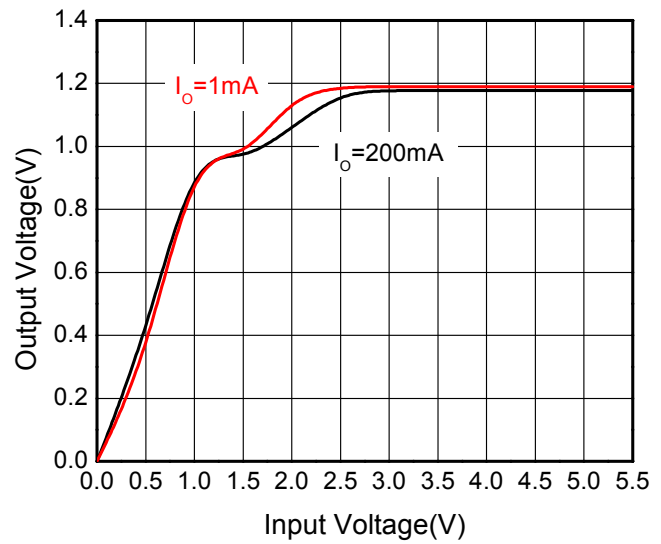

**Output voltage vs. Supply voltage**

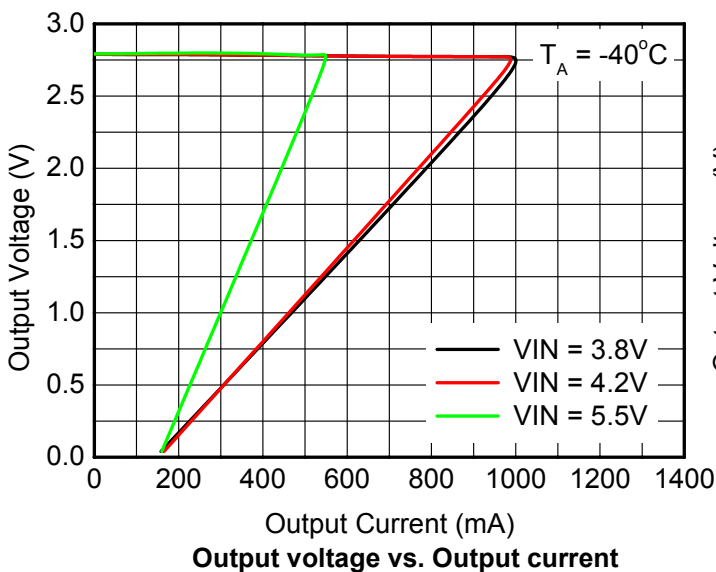

**Output voltage vs. Output current**

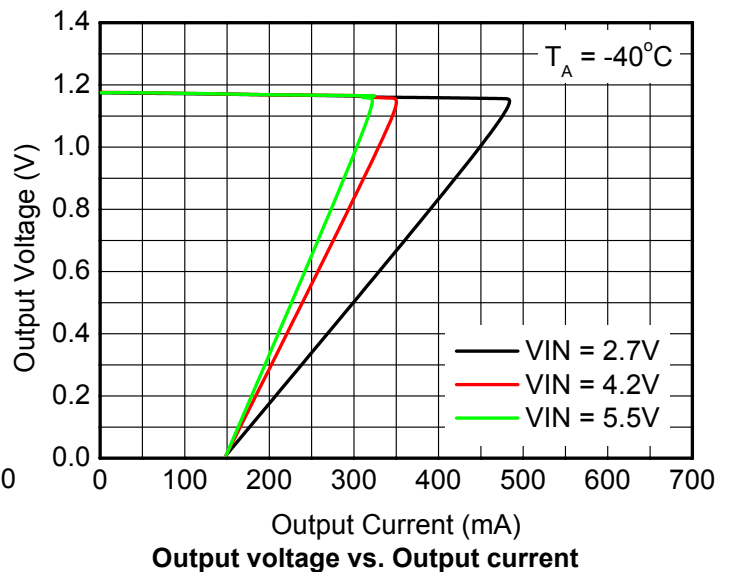

**Output voltage vs. Output current**

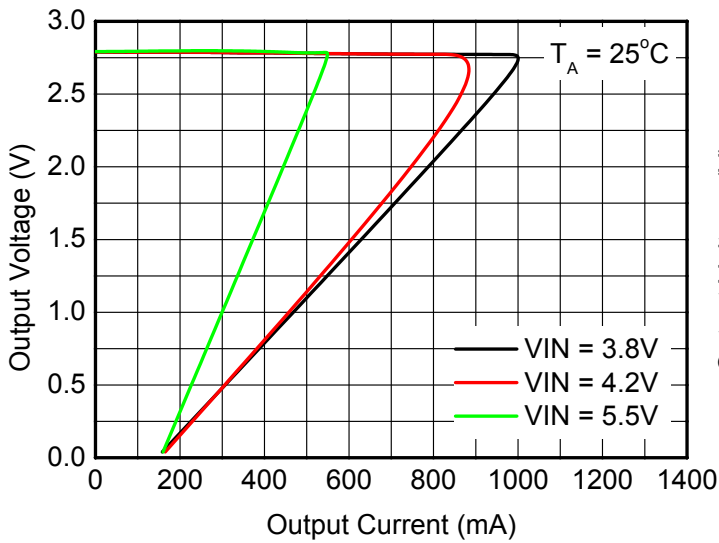
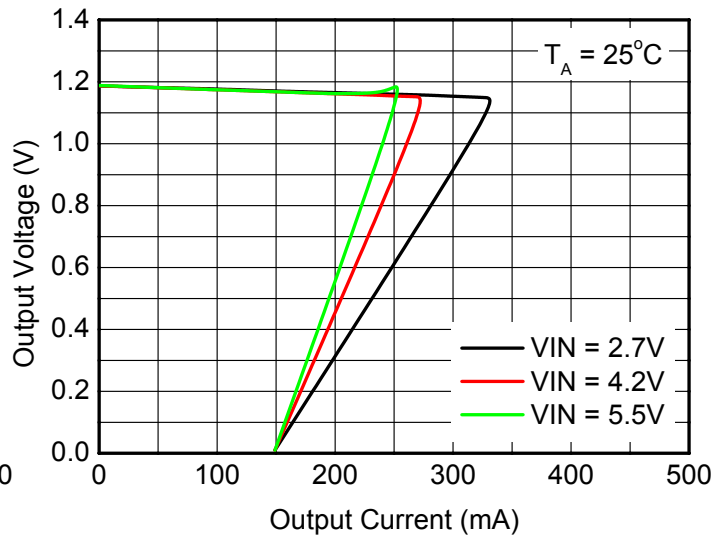
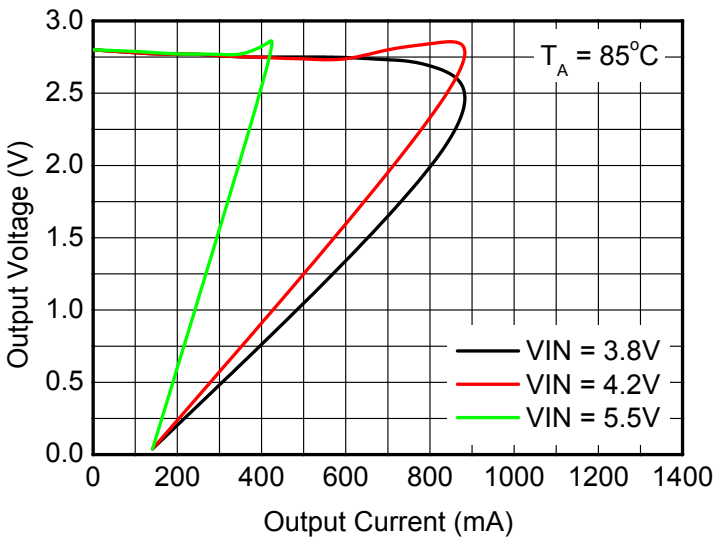
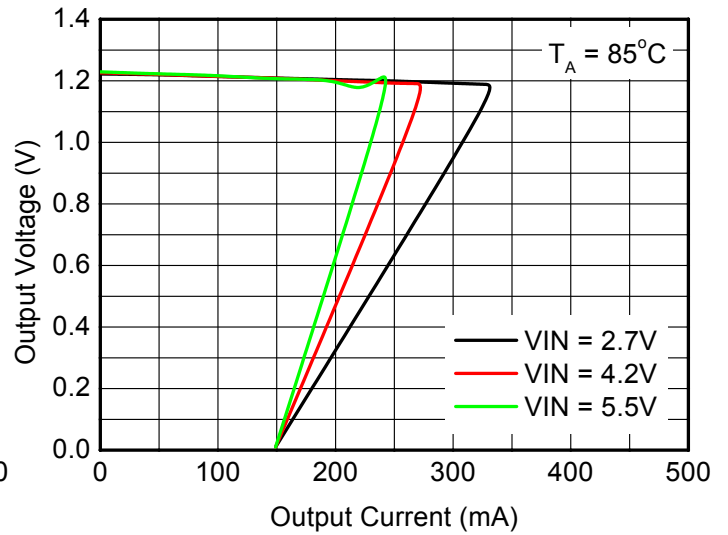
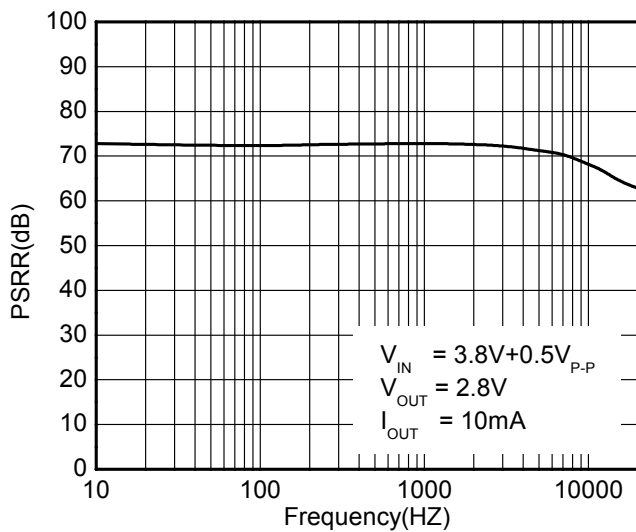
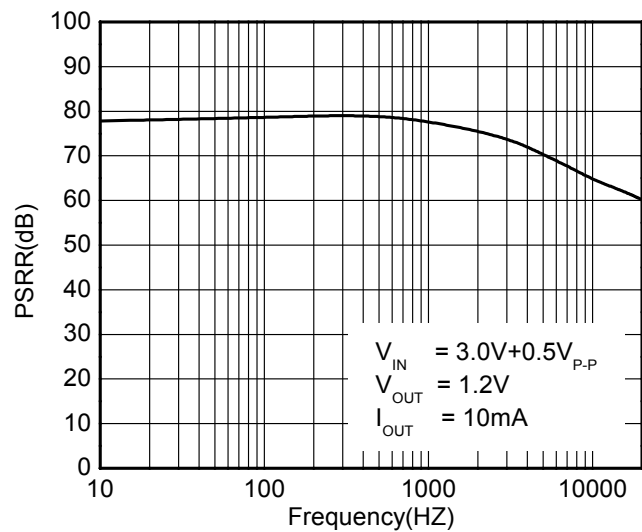
**Output voltage vs. Output current**

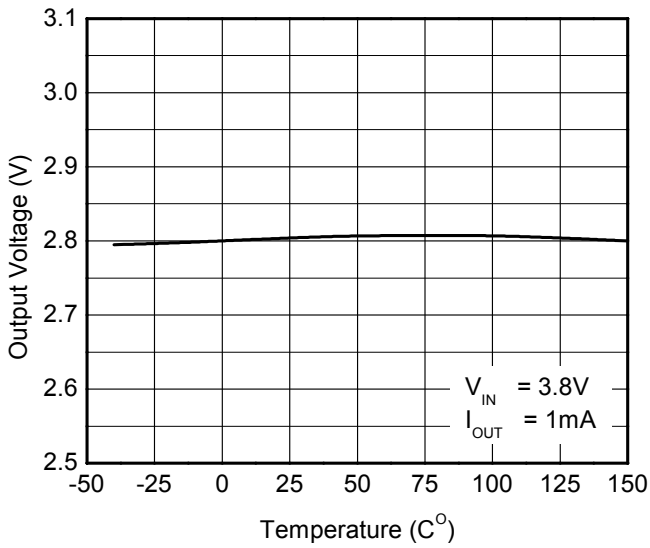
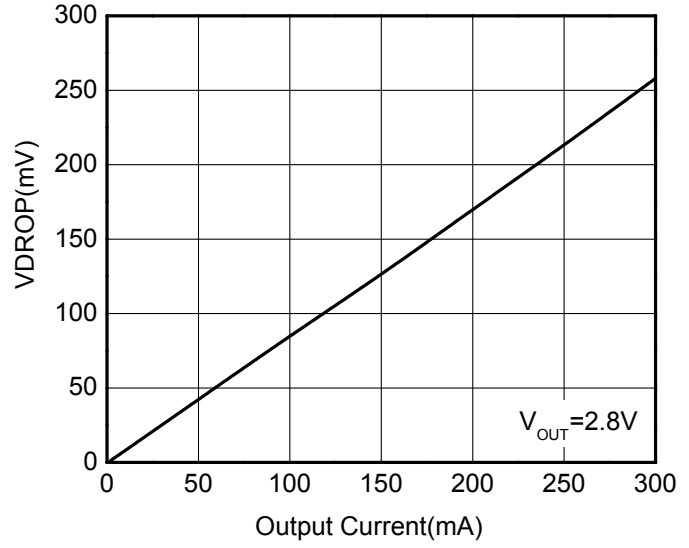
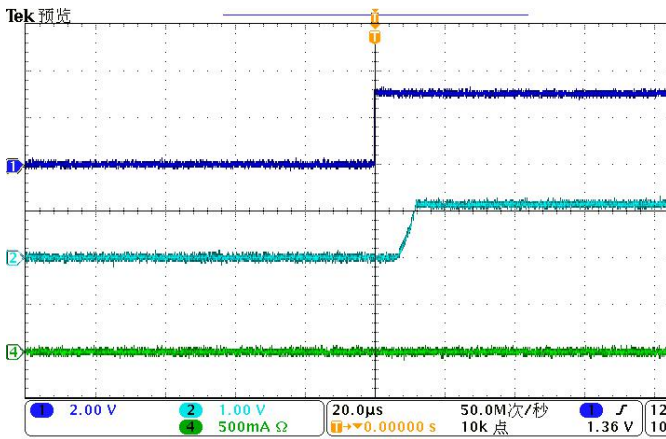
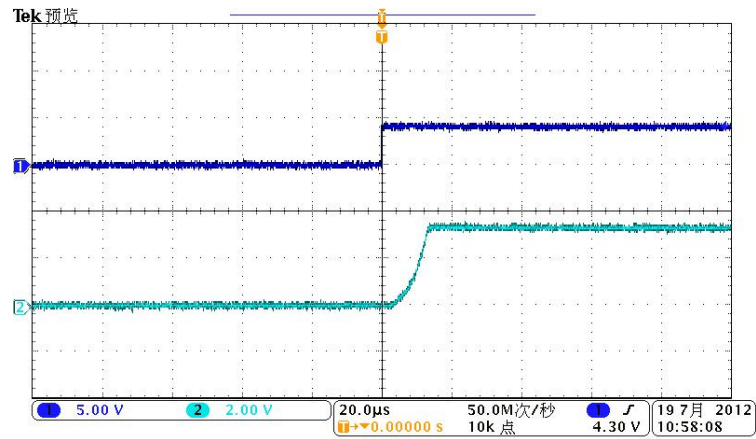
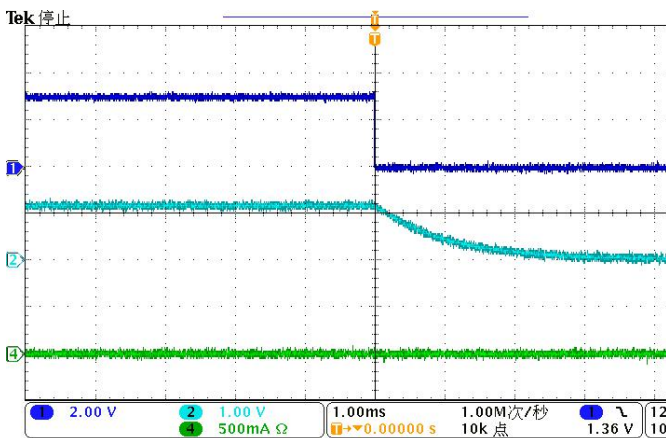
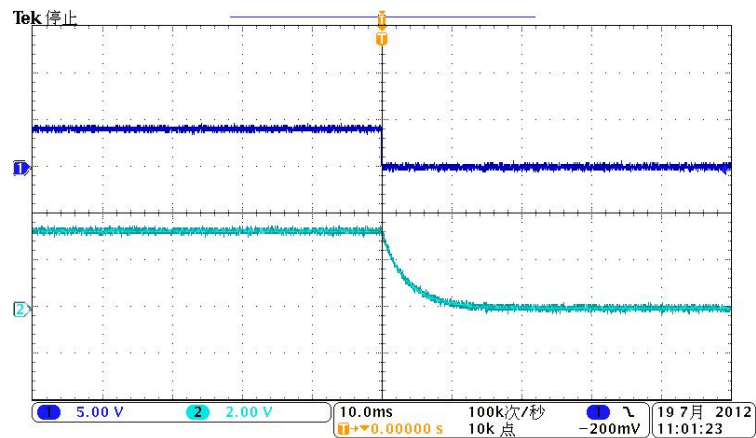
**Output voltage vs. Output current**

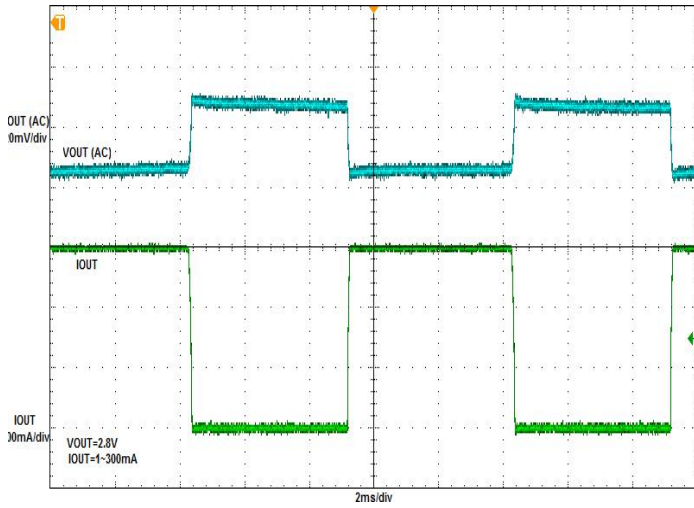
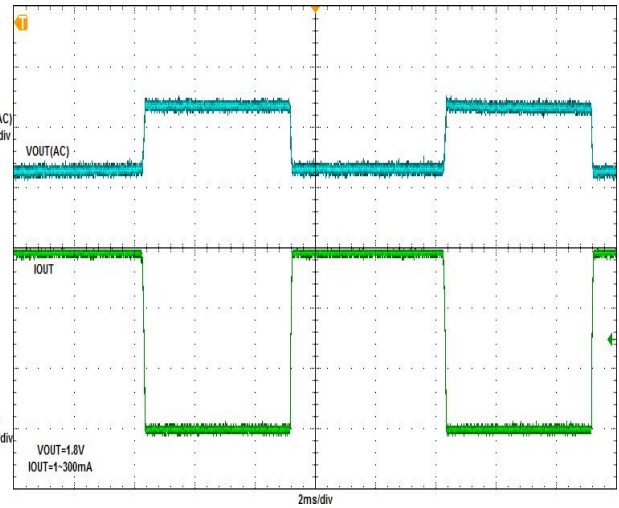
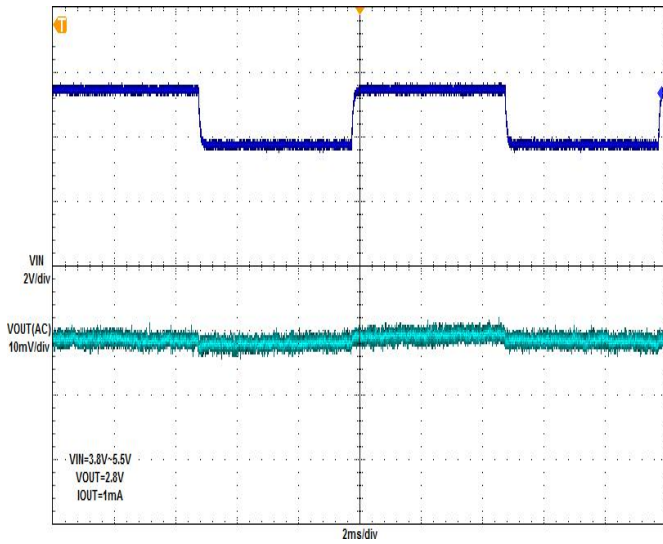
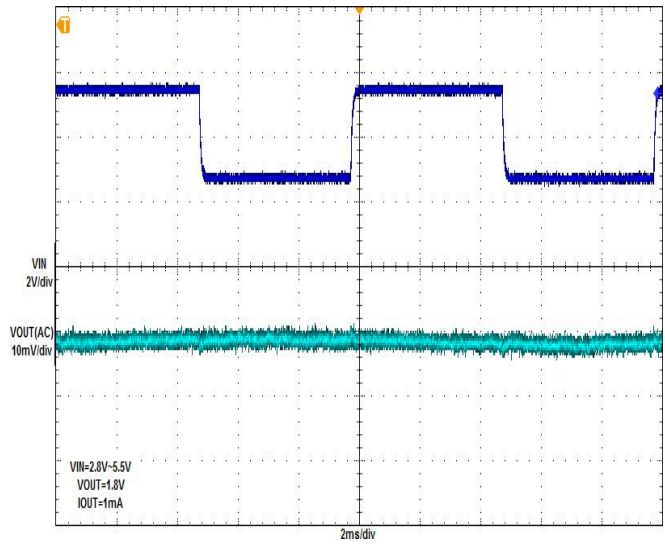
**Output voltage vs. Output current**

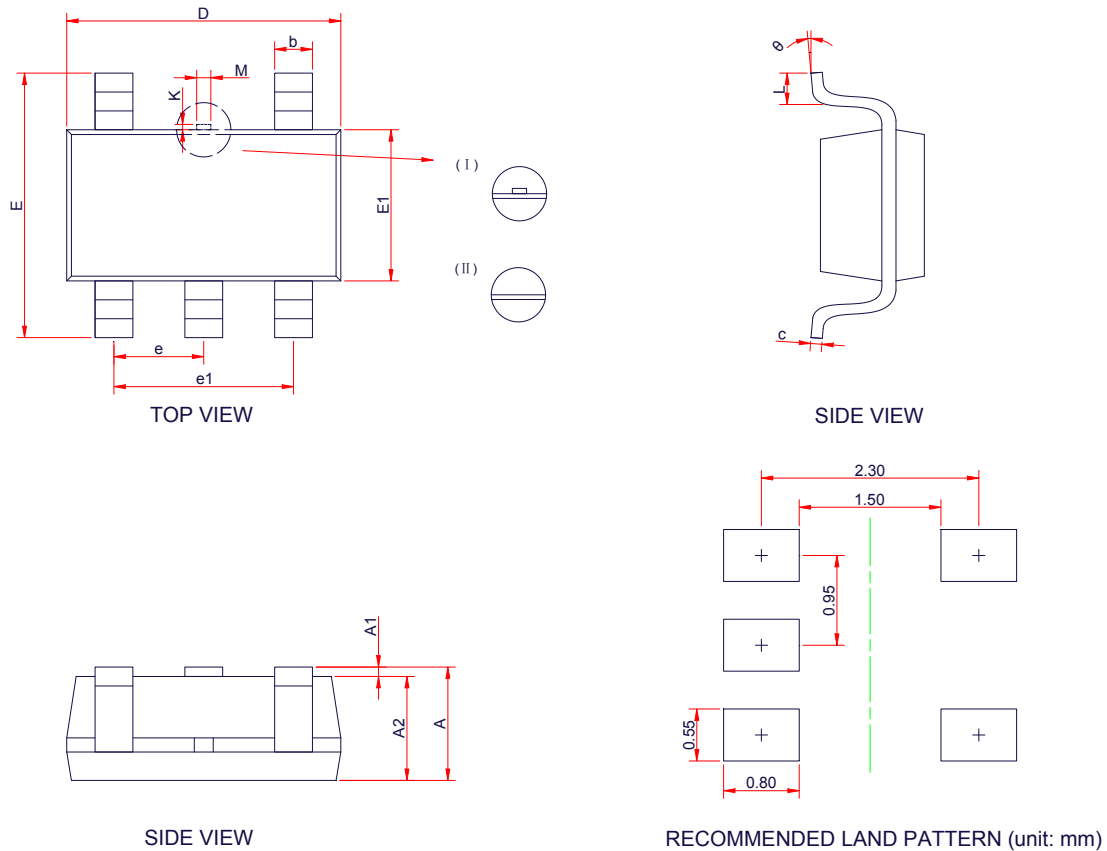
**Output voltage vs. Output current**

**PSRR**

**PSRR**



**Output voltage vs. Temperature**

**Dropout Voltage vs. Output Current**

**Start Up**

**Start Up**

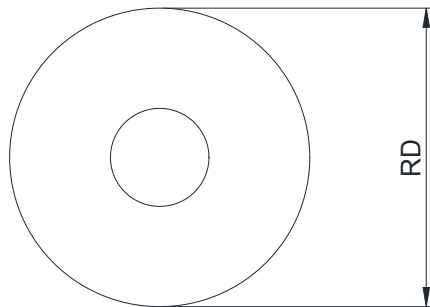
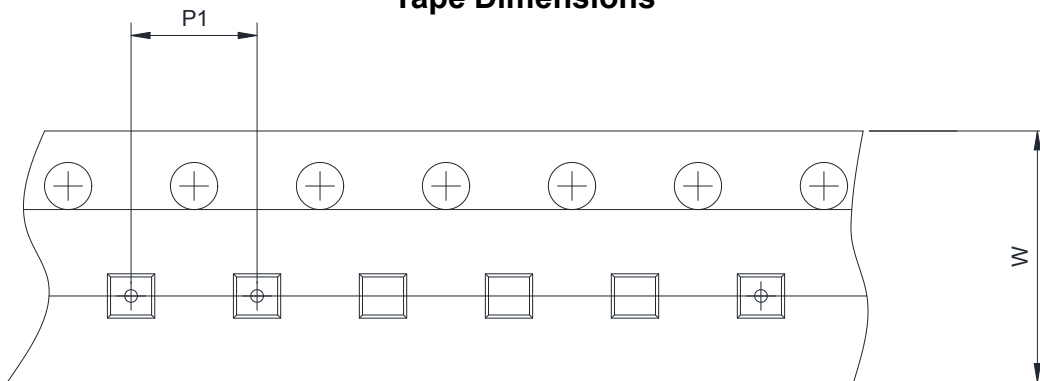
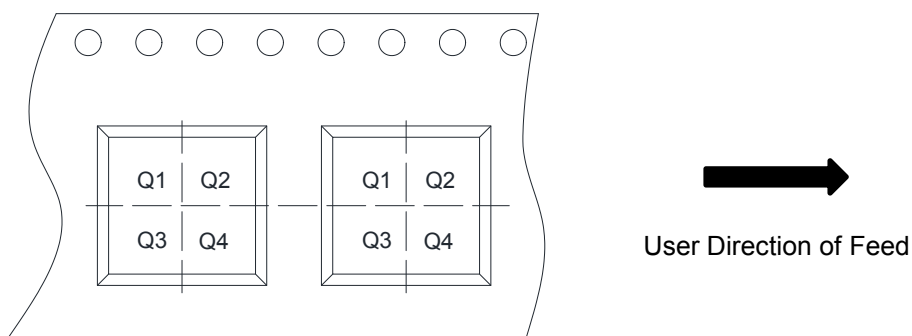
**Shutdown**

**Shutdown**

**Load Step**

**Load Step**

**Line Step**

**Line Step**

**PACKAGE OUTLINE DIMENSIONS**
**SOT-23-5L**

Symbol	Dimensions in Millimeters		
	Min.	Typ.	Max.
A	-	-	1.45
A1	0.00	-	0.15
A2	0.90	1.10	1.30
b	0.30	0.40	0.50
c	0.10	-	0.21
D	2.72	2.92	3.12
E	2.60	2.80	3.00
E1	1.40	1.60	1.80
e	0.95 BSC		
e1	1.90 BSC		
L	0.30	0.45	0.60
M	0.10	0.15	0.25
K	0.00	-	0.25
θ	0°	-	8°



**TAPE AND REEL INFORMATION**
**Reel Dimensions**

**Tape Dimensions**

**Quadrant Assignments For PIN1 Orientation In Tape**

RD	Reel Dimension	<input checked="" type="checkbox"/> 7inch	<input type="checkbox"/> 13inch
W	Overall width of the carrier tape	<input checked="" type="checkbox"/> 8mm	<input type="checkbox"/> 12mm <input type="checkbox"/> 16mm
P1	Pitch between successive cavity centers	<input type="checkbox"/> 2mm	<input checked="" type="checkbox"/> 4mm <input type="checkbox"/> 8mm
Pin1	Pin1 Quadrant	<input type="checkbox"/> Q1	<input type="checkbox"/> Q2 <input checked="" type="checkbox"/> Q3 <input type="checkbox"/> Q4

## ORDER INFORMATION

Ordering No.	Vout (V)	Package	Operating Temperature	Marking	Shipping
WL2801E12-5/TR	1.2	SOT-23-5L	-40~+85°C	WE12 YYWW	Tape and Reel, 3000
WL2801E13-5/TR	1.3	SOT-23-5L	-40~+85°C	WE13 YYWW	Tape and Reel, 3000
WL2801E15-5/TR	1.5	SOT-23-5L	-40~+85°C	WE15 YYWW	Tape and Reel, 3000
WL2801E18-5/TR	1.8	SOT-23-5L	-40~+85°C	WE18 YYWW	Tape and Reel, 3000
WL2801E25-5/TR	2.5	SOT-23-5L	-40~+85°C	WE25 YYWW	Tape and Reel, 3000
WL2801E28-5/TR	2.8	SOT-23-5L	-40~+85°C	WE28 YYWW	Tape and Reel, 3000
WL2801E30-5/TR	3.0	SOT-23-5L	-40~+85°C	WE30 YYWW	Tape and Reel, 3000
WL2801E33-5/TR	3.3	SOT-23-5L	-40~+85°C	WE33 YYWW	Tape and Reel, 3000

**Marking:**

**WE\*\*** = Device Code

**YY** = Year

**WW** = Week

## X-ON Electronics

Largest Supplier of Electrical and Electronic Components

*Click to view similar products for [Linear Voltage Regulators](#) category:*

*Click to view products by [Will Semiconductor](#) manufacturer:*

Other Similar products are found below :

[LV56831P-E](#) [LV5684PVD-XH](#) [MCDTSA6-2R](#) [L7815ACV-DG](#) [PQ3DZ53U](#) [LV56801P-E](#) [TLE42794G](#) [L78L05CZ/1SX](#) [L78LR05DL-MA-E](#) [636416C](#) [714954EB](#) [BA033LBSG2-TR](#) [LV5680P-E](#) [L78M15CV-DG](#) [TLS202B1MBV33HTSA1](#) [L79M05T-E](#) [TLS202A1MBVHTSA1](#) [L78LR05D-MA-E](#) [NCV317MBTG](#) [NTE7227](#) [LV5680NPVC-XH](#) [LT1054CN8](#) [MP2018GZD-5-Z](#) [MP2018GZD-33-Z](#) [MIC5281-3.3YMM](#) [RT9078-28GQZ](#) [MC78L06BP-AP](#) [TA48LS05F\(TE85L,F\)](#) [TA78L12F\(TE12L,F\)](#) [TC47BR5003ECT](#) [TCR2LN12,LF\(S](#) [TCR2LN28,LF\(S](#) [TCR2LN30,LF\(S](#) [TCR3DF295,LM\(CT](#) [TCR3DF40,LM\(CT](#) [BA178M20CP-E2](#) [L78M12ABDT](#) [LM7812SX/NOPB](#) [LR645N3-G-P003](#) [LR645N3-G-P013](#) [ZXTR2005P5-13](#) [SCD7812BTG](#) [TCR3DF335,LM\(CT](#) [ZXTR2012K-13](#) [TLE42994E V33](#) [ZXTR2008K-13](#) [ZXTR2005K-13](#) [LA5693D-E](#) [L88R05DL-E](#) [ADP3300ARTZ-2.7RL7](#)