

WL2808E

Low noise, High PSRR, High speed, CMOS LDO

<http://www.omnivision-group.com/>

Descriptions

The WL2808E series is a high accuracy, low noise, high speed, low dropout CMOS Linear regulator with high ripple rejection. The devices offer a new level of cost effective performance in cellular phones, laptop and notebook computers, and other portable devices.

The current limiter's fold-back circuit also operates as a short circuit protection and an output current limiter at the output pin.

The WL2808E regulators are available in standard SOT-23-5L packages. Standard products are Pb-free and Halogen-free.



SOT-23-5L

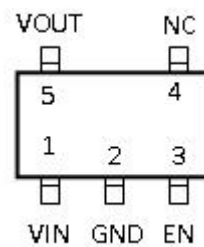

Features

- Input voltage : 2.5V~5.5V
- Output range : 1.2V~3.3V
- Output current : 200mA (@V_{OUT}<2V)(Typ.)
- : 300mA (@V_{OUT}>2V)(Typ.)
- PSRR : 75dB @ 217Hz
- Dropout voltage : 170mV @ I_{OUT}=200mA
- Quiescent current : 30μA Typ.
- Shut-down current : < 1μA
- Recommend capacitor : 1uF

Pin Configuration (Top View)

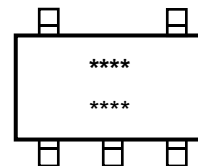

For detail marking information, please see page 8.

Marking

Applications

- MP3/MP4 Players
- Cellphones, radiophone, digital cameras
- Bluetooth, wireless handsets
- Others portable electronics device

Order Information

For detail order information, please see page 8.

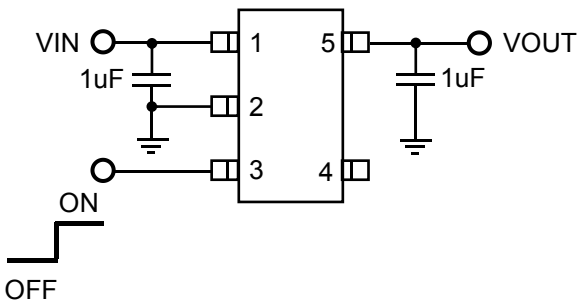
Typical Application

Pin Description

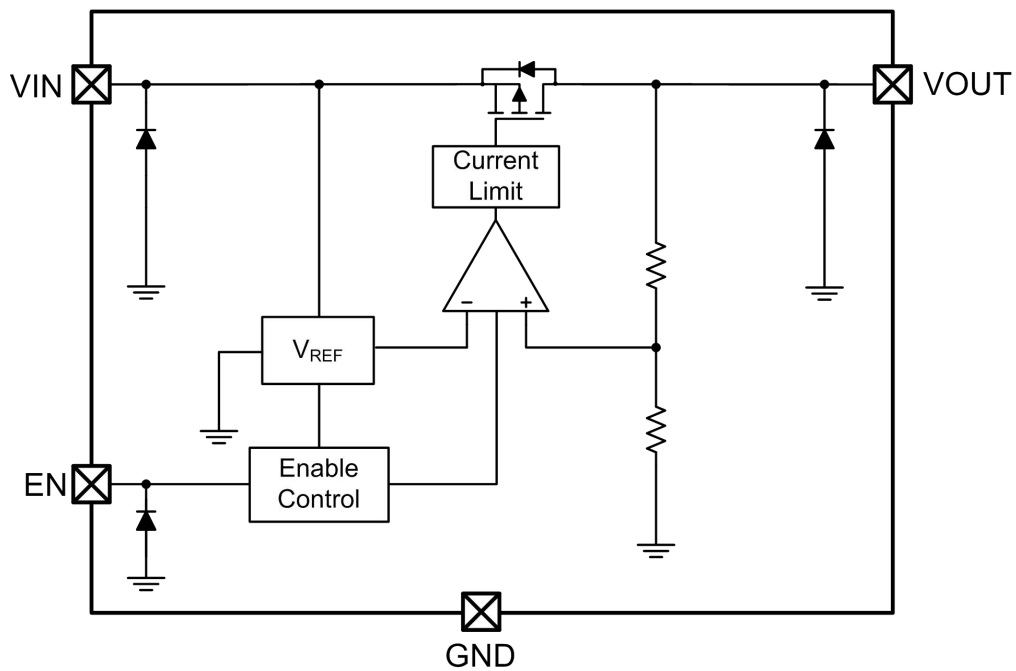
PIN	Symbol	Description
1	VIN	Input
2	GND	Ground
3	EN	Enable (Active high)
4	NC	Not connected
5	VOUT	Output

Block Diagram

Absolute Maximum Ratings

Parameter	Value	Unit
Power Dissipation	Internal limited	mW
V _{IN} Range	-0.3~6.5	V
V _{EN} Range	-0.3~V _{IN}	V
V _{OUT} Range	-0.3~V _{IN}	V
Lead Temperature Range	260	°C
Storage Temperature Range	-55 ~ 150	°C
Operating Junction Temperature Range	150	°C

Recommend Operating Ratings

Parameter	Value	Unit
Operating Supply voltage	2.5~5.5	V
Operating Temperature Range	-40~85	°C
Thermal Resistance, R _{θJA}	250	°C/W

Electronics Characteristics (Ta=25°C, V_{IN}=V_{OUT}+1V, C_{IN}=C_{OUT}=1μF, unless otherwise noted)

Parameter	Symbol	Condition	Min.	Typ.	Max.	Unit
Output Voltage	V _{OUT}	V _{OUT} < 2V, V _{IN} =2.7V, I _{OUT} =1mA	0.97 V _{OUT}	V _{OUT}	1.03 V _{OUT}	V
		V _{OUT} ≥ 2V, I _{OUT} =1mA	0.98 V _{OUT}	V _{OUT}	1.02 V _{OUT}	
Current Limit	I _{LIM}	V _{EN} =V _{IN}	Ref. to Output Voltage vs. Output Current Chart			mA
Dropout Voltage	V _{DROP}	V _{OUT} =2.8V, I _{OUT} =200mA		170	200	mV
		V _{OUT} =2.8V, I _{OUT} =300mA		250	300	
Line Regulation	ΔV _{LINE}	V _{IN} =2.7~5.5V, I _{OUT} =1mA		0.01	0.15	%/V
Load Regulation	ΔV _{Load}	V _{OUT} =2.8V, I _{OUT} =1~300mA		20	35	mV
Quiescent Current	I _Q	V _{OUT} =2.8V, I _{OUT} =0		30	50	μA
Short Current	I _{SHORT}	V _{EN} =V _{IN} , V _{OUT} Short to GND with 1Ω		90		mA
Shut-down Current	I _{SHDN}	V _{EN} =0V			1.0	μA
Power Supply Rejection Rate	PSRR	V _{IN} =(V _{OUT} +1V) _{DC} +0.5V _{P-P} F=217Hz, I _{OUT} =10mA		75		dB
		V _{IN} =(V _{OUT} +1V) _{DC} +0.5V _{P-P} F=10KHz, I _{OUT} =10mA		65		
EN logic high voltage	V _{ENH}	V _{IN} =5.5V, I _{OUT} =1mA	1.2			V
EN logic low voltage	V _{ENL}	V _{IN} =5.5V, V _{OUT} =0V			0.4	V
EN Input Current	I _{EN}	V _{EN} = 0 to 5.5V			1.0	μA
Output Noise Voltage	e _{NO}	10Hz to 100KHz, C _{OUT} =1μF		100		μV _{RMS}

Typical characteristics ($T_a=25^\circ\text{C}$, $V_{IN}=3.8\text{V}$, $V_{OUT}=2.8\text{V}$ $C_{IN}=C_{OUT}=1\mu\text{F}$, unless otherwise noted)

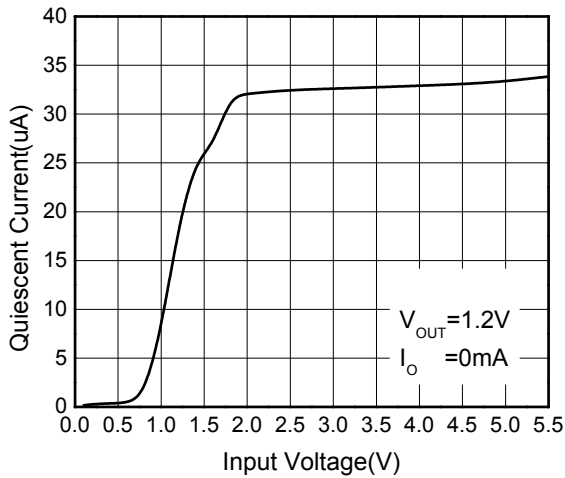

Quiescent current vs. Supply voltage

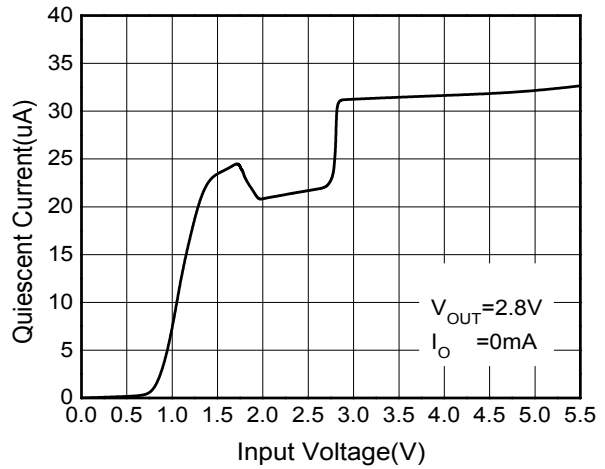

Quiescent current vs. Supply voltage

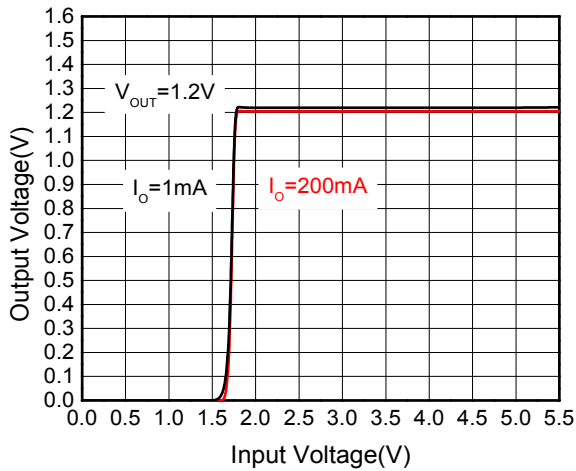

Output voltage vs. Supply voltage

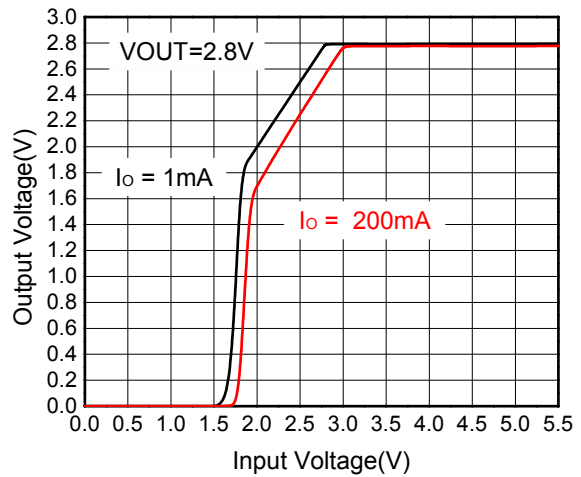

Output voltage vs. Supply voltage

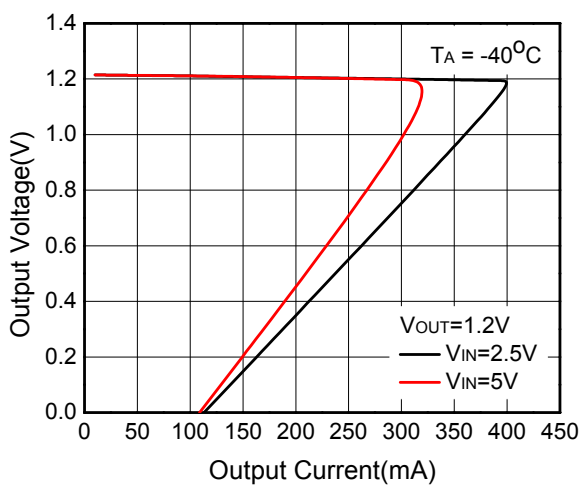

Output voltage vs. Output current

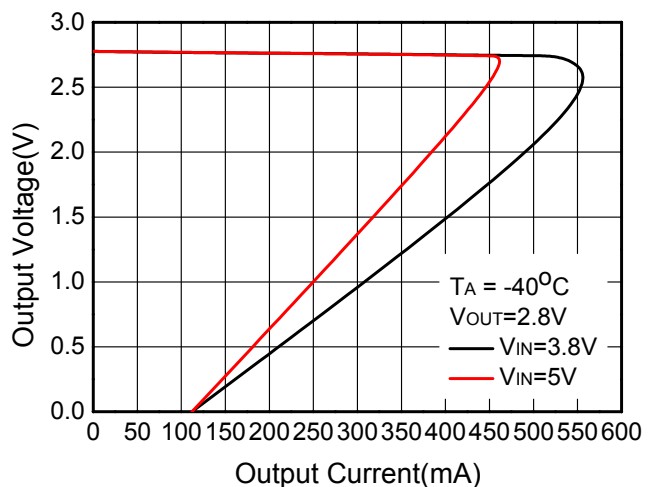

Output voltage vs. Output current

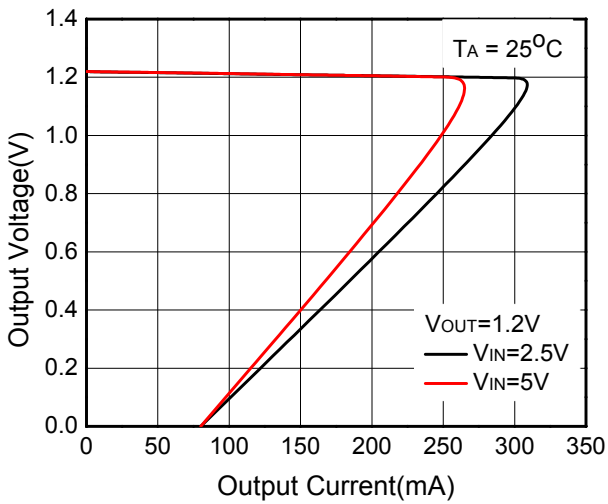
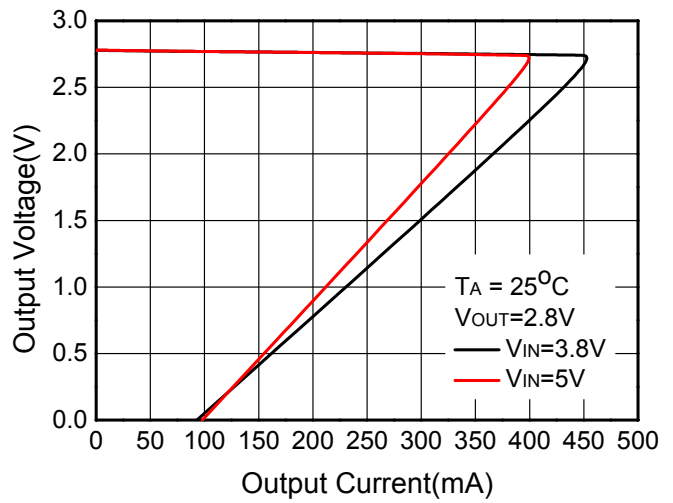
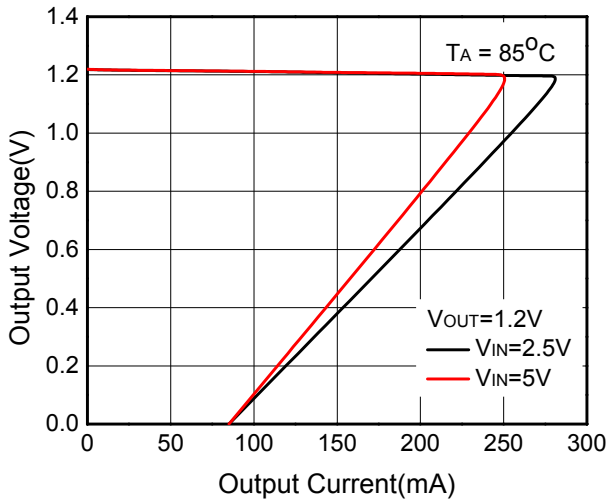
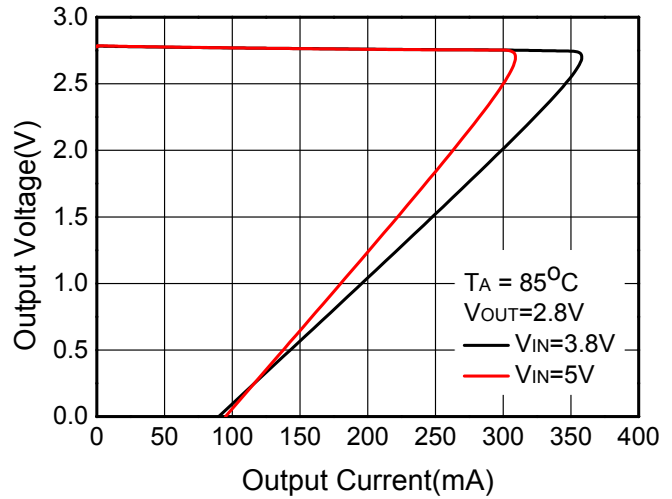
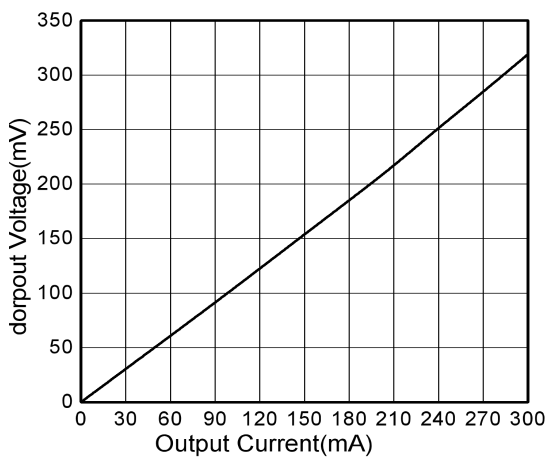
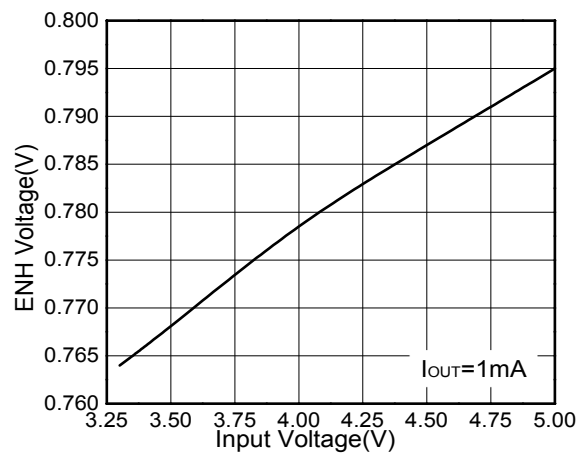
Output Voltage vs. Output Current

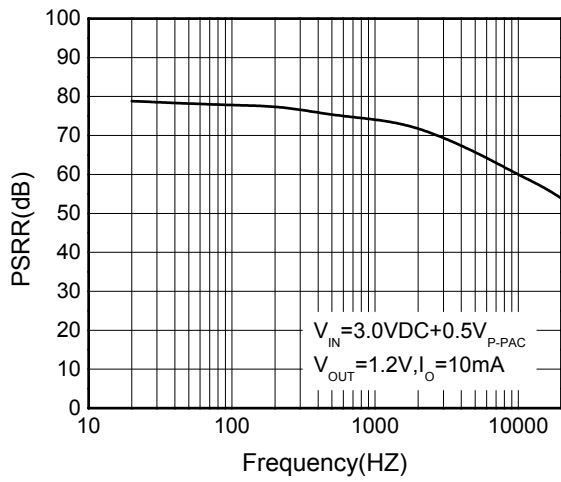
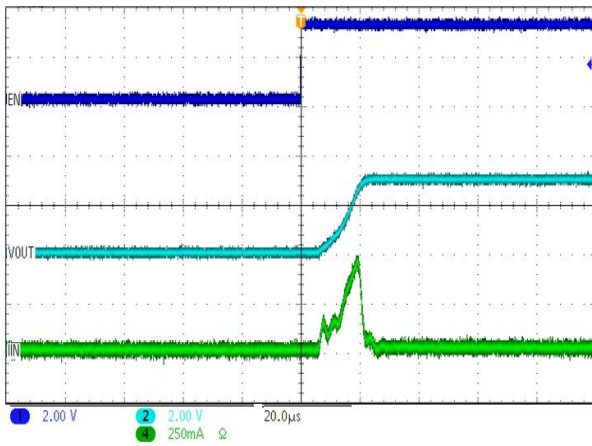
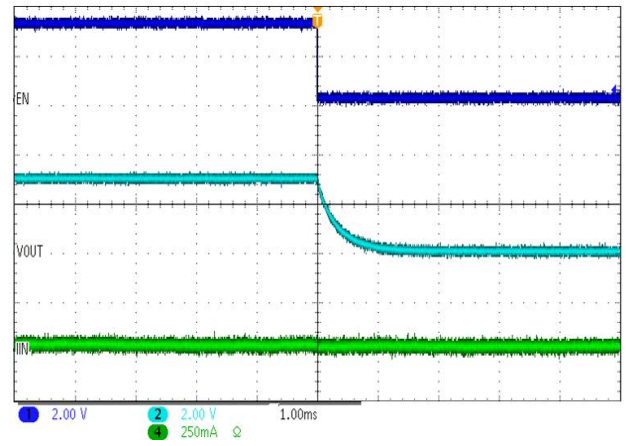
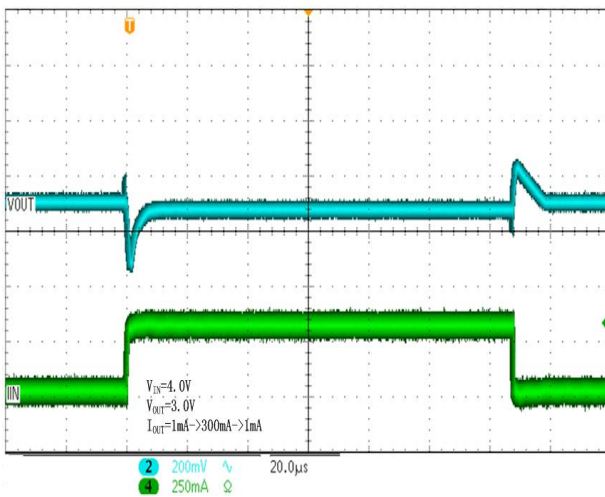
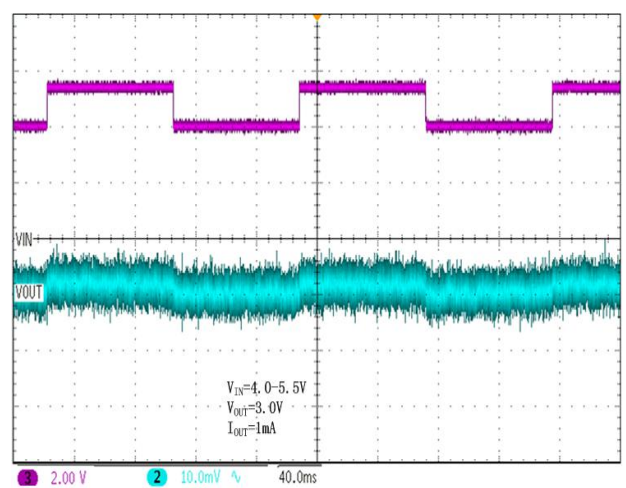
Output Voltage vs. Output Current

Output Voltage vs. Output Current

Output Voltage vs. Output Current

Dropout Voltage vs. Output Current

ENH Voltage vs. Supply Voltage



PSRR

Start Up

Shutdown

Load Step

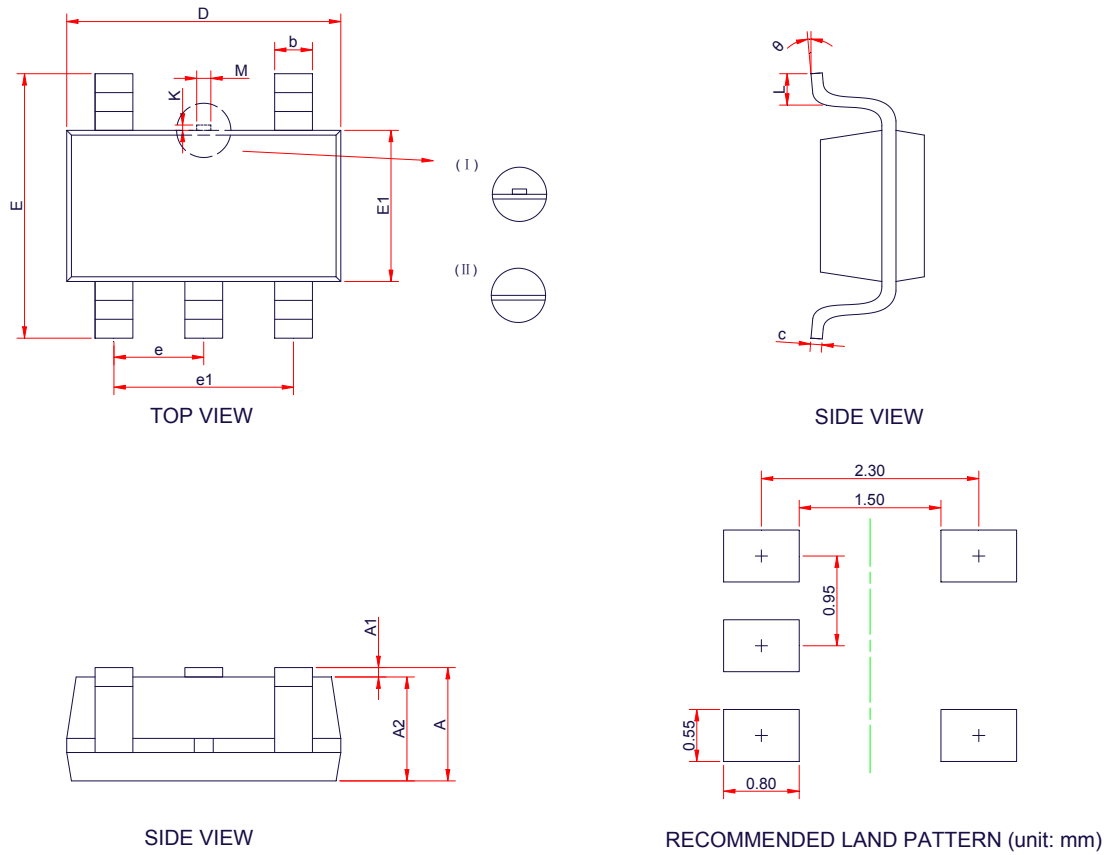
Line Step

ORDER INFORMATION

Ordering No.	Vout (V)	Package	Operating Temperature	Marking	Shipping
WL2808E12-5/TR	1.2	SOT-23-5L	-40~+85°C	WL12 EYWW	Tape and Reel, 3000
WL2808E15-5/TR	1.5	SOT-23-5L	-40~+85°C	WLBF EYWW	Tape and Reel, 3000
WL2808E18-5/TR	1.8	SOT-23-5L	-40~+85°C	WLBJ EYWW	Tape and Reel, 3000
WL2808E25-5/TR	2.5	SOT-23-5L	-40~+85°C	WLCF EYWW	Tape and Reel, 3000
WL2808E28-5/TR	2.8	SOT-23-5L	-40~+85°C	WL28 EYWW	Tape and Reel, 3000
WL2808E30-5/TR	3.0	SOT-23-5L	-40~+85°C	WLDA EYWW	Tape and Reel, 3000
WL2808E33-5/TR	3.3	SOT-23-5L	-40~+85°C	WLDD EYWW	Tape and Reel, 3000

Marking:

WL** = Device Code
Y = Year
WW = Week

PACKAGE OUTLINE DIMENSIONS
SOT-23-5L

Symbol	Dimensions in Millimeters		
	Min.	Typ.	Max.
A	-	-	1.25
A1	0.00	-	0.15
A2	1.00	1.10	1.20
b	0.30	0.40	0.50
c	0.10	-	0.21
D	2.72	2.92	3.12
E	2.60	2.80	3.00
E1	1.40	1.60	1.80
e	0.95 BSC		
e1	1.90 BSC		
L	0.30	0.45	0.60
M	0.10	0.15	0.25
K	0.00	-	0.25
θ	0°	-	8°

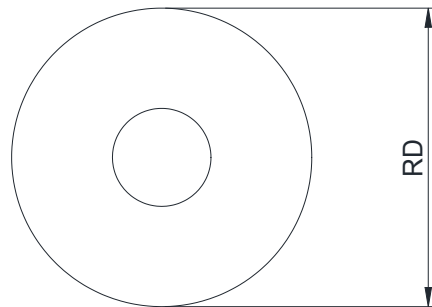
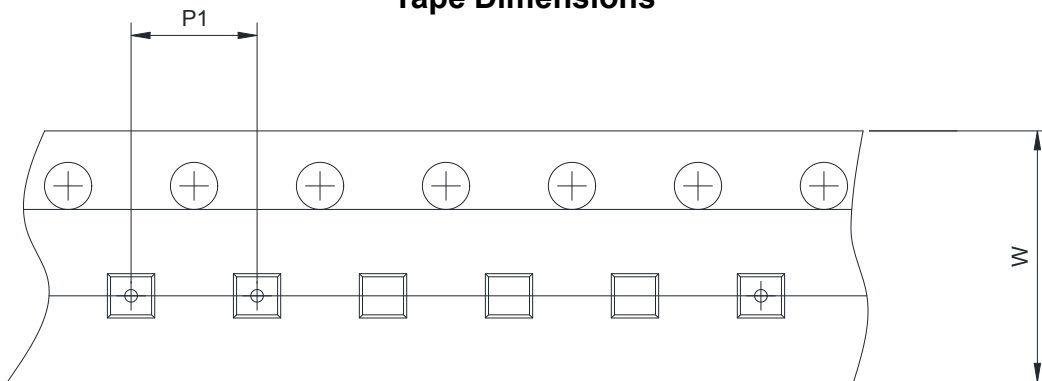
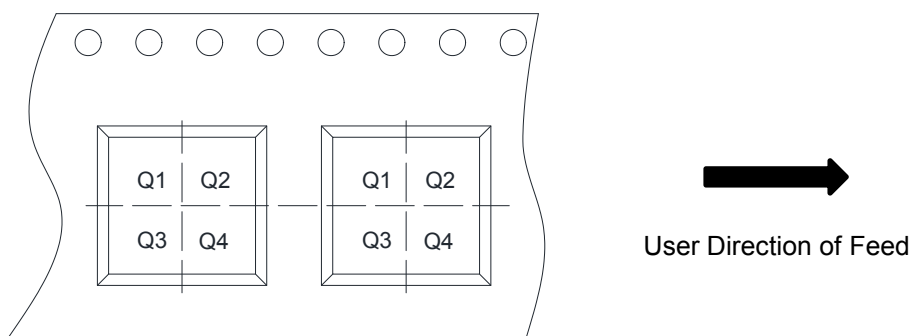
TAPE AND REEL INFORMATION
Reel Dimensions

Tape Dimensions

Quadrant Assignments For PIN1 Orientation In Tape

RD	Reel Dimension	<input checked="" type="checkbox"/> 7inch	<input type="checkbox"/> 13inch
W	Overall width of the carrier tape	<input checked="" type="checkbox"/> 8mm	<input type="checkbox"/> 12mm <input type="checkbox"/> 16mm
P1	Pitch between successive cavity centers	<input type="checkbox"/> 2mm	<input checked="" type="checkbox"/> 4mm <input type="checkbox"/> 8mm
Pin1	Pin1 Quadrant	<input type="checkbox"/> Q1	<input type="checkbox"/> Q2 <input checked="" type="checkbox"/> Q3 <input type="checkbox"/> Q4

X-ON Electronics

Largest Supplier of Electrical and Electronic Components

Click to view similar products for [Linear Voltage Regulators](#) category:

Click to view products by [Will Semiconductor](#) manufacturer:

Other Similar products are found below :

[LV5684PVD-XH](#) [MCDTSA6-2R](#) [L7815ACV-DG](#) [LV56801P-E](#) [UA7805CKC](#) [714954EB](#) [ZMR500QFTA](#) [BA033LBSG2-TR](#)
[NCV78M05ABDTRKG](#) [LV5680P-E](#) [L79M05T-E](#) [L78LR05D-MA-E](#) [NCV317MBTG](#) [NTE7227](#) [MP2018GZD-33-P](#) [MP2018GZD-5-P](#)
[LV5680NPVC-XH](#) [ZTS6538SE](#) [UA78L09CLP](#) [UA78L09CLPR](#) [CAT6221-PPTD-GT3](#) [MC78M09CDTRK](#) [NCV51190MNTAG](#)
[BL1118CS8TR1833](#) [BL8077CKETR33](#) [BL9153-33CC3TR](#) [BL9161G-28BADRN](#) [BRCO7530MMC](#) [CJ7815B-TFN-ARG](#) [LM317C](#)
[GM7333K](#) [GM7350K](#) [XC6206P332MR](#) [HT7533](#) [LM7912S/TR](#) [LT1764S/TR](#) [LM7805T](#) [LM338T](#) [LM1117IMP-3.3/TR](#) [HT1117AM-3.3](#)
[HT7550S](#) [AMS1117-3.3](#) [HT7150S](#) [78L12](#) [HT7550](#) [HT7533-1](#) [HXY6206I-2.5](#) [HT7133](#) [HT7533S](#) [662K](#)