

WL2810

Low noise, High PSRR, High speed, CMOS LDO

[Http://www.sh-willsemi.com](http://www.sh-willsemi.com)

Descriptions

The WL2810 series is a high accuracy, low noise, high speed, low dropout CMOS Linear regulator with high ripple rejection. The devices offer a new level of cost effective performance in cellular phones, laptop and notebook computers, and other portable devices.

The WL2810 has the fold-back maximum output current which depends on the output voltage. So the current limit functions both as a short circuit protection and as an output current limiter.

The WL2810 regulators are available in standard SOT-353 package and DFN1x1-4L Package. Standard products are Pb-free and Halogen-free.



SOT-353



DFN1X1-4L

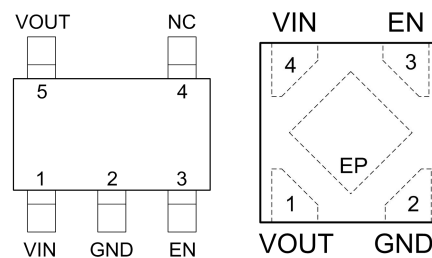

Pin Configuration (Top View)

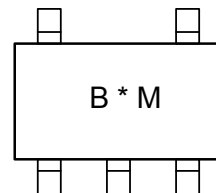

B : Package Code
***** : Voltage Code
M : Month(A~Z)

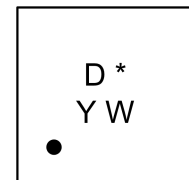

D : Package Code
***** : Voltage Code
Y : Year Code
W : Week Code

For detail marking information, please see page 10.

Marking

Features

- Input voltage : 2.2V~5.5V
- Output range : 1.0V~3.3V
- Output current : 300mA
- PSRR : 70dB @ 217Hz
- Dropout voltage : 250mV @ I_{OUT}=300mA
- Quiescent current : 42μA Typ.
- Shut-down current : < 1μA
- Recommend capacitor : 1uF

Applications

- MP3/MP4 Players
- Cellphones, radiophone, digital cameras
- Bluetooth, wireless handsets
- Others portable electronics device

Order Information

For detail order information, please see page 10.

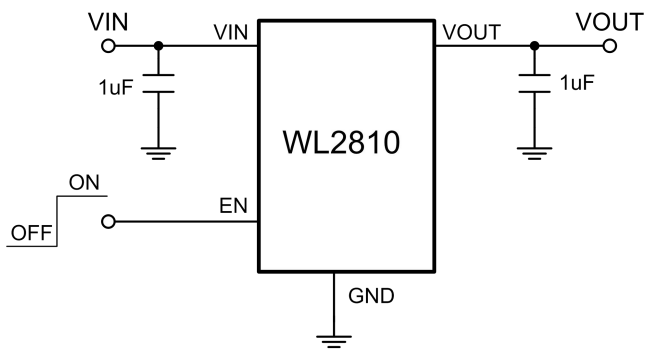
Typical Application

Pin Description
SOT-353

PIN	Symbol	Description
1	VIN	Input
2	GND	Ground
3	EN	Enable (Active high)
4	NC	Not connected
5	VOUT	Output

DFN1X1-4L

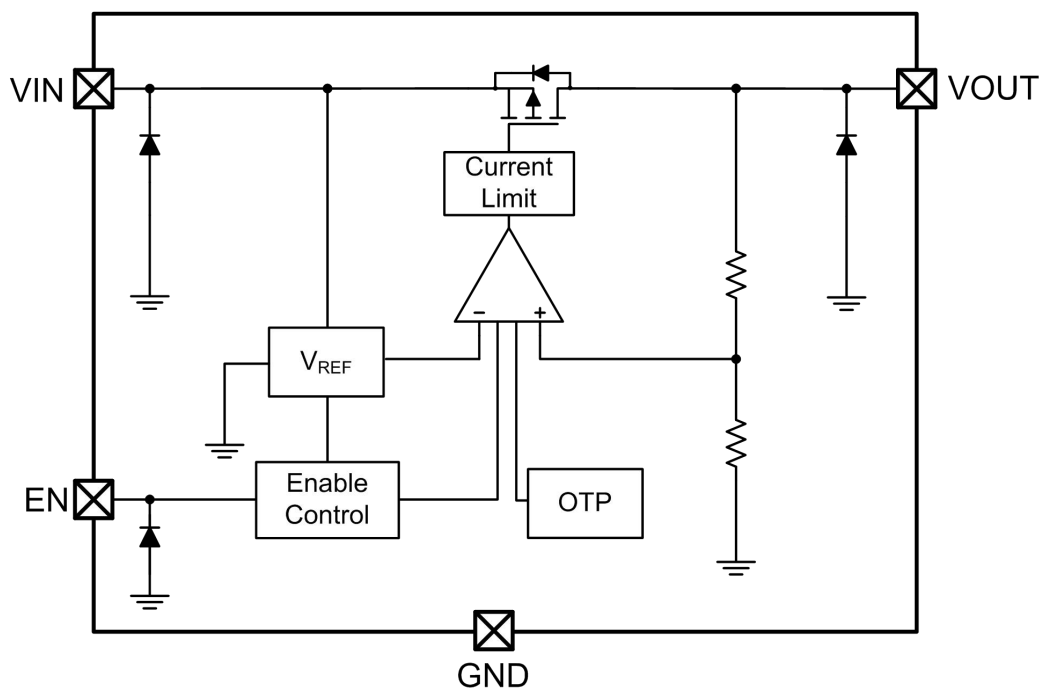
PIN	Symbol	Description
1	VOUT	Output
2	GND	Ground
3	EN	Enable (Active high)
4	VIN	Input
EP		GND level, this pin must connect to GND.

Block Diagram

Absolute Maximum Ratings

Parameter	Value	Unit	
Power Dissipation, $P_D@T_A=25^\circ\text{C}$	400	mW	
V_{IN} Range	-0.3~6.5	V	
V_{EN} Range	-0.3~ V_{IN}	V	
V_{OUT} Range	-0.3~ V_{IN}	V	
I_{OUT}	400	mA	
Lead Temperature Range	260	$^\circ\text{C}$	
Storage Temperature Range	-55 ~ 150	$^\circ\text{C}$	
Operating Junction Temperature Range	150	$^\circ\text{C}$	
ESD Ratings	HBM	8000	V
	MM	400	V

Recommend Operating Ratings

Parameter	Value	Unit
Operating Supply voltage	2.2~5.5	V
Operating Temperature Range	-40~85	$^\circ\text{C}$
Thermal Resistance, $R_{\theta JA}$ (SOT-353)	250	$^\circ\text{C/W}$
Thermal Resistance, $R_{\theta JA}$ (DFN1x1-4L)	250	$^\circ\text{C/W}$

Electronics Characteristics (Ta=25°C, V_{IN}=V_{OUT}+1V, C_{IN}=C_{OUT}=1μF, unless otherwise noted)

Parameter	Symbol	Condition	Min.	Typ.	Max.	Unit
Output Voltage	V _{OUT}	V _{OUT} ≤ 1.5V, V _{IN} =2.7V, I _{OUT} =1mA	0.97 V _{OUT}	V _{OUT}	1.03 V _{OUT}	V
		V _{OUT} > 1.5V, I _{OUT} =1mA	0.98 V _{OUT}	V _{OUT}	1.02 V _{OUT}	
Current Limit	I _{LIM}	V _{EN} =V _{IN}	300			mA
Dropout Voltage	V _{DROP}	V _{OUT} =3.3V, I _{OUT} =300mA		220	330	mV
		V _{OUT} =3.0V, I _{OUT} =300mA		240	360	
		V _{OUT} =2.8V, I _{OUT} =300mA		250	375	
		V _{OUT} =2.5V, I _{OUT} =300mA		280	420	
		V _{OUT} =1.8V, I _{OUT} =300mA		400	600	
		V _{OUT} ≤ 1.5V, I _{OUT} =300mA	V _{in-min} =2.2V			
Line Regulation	ΔV _{LINE}	V _{IN} =2.7~5.5V, I _{OUT} =1mA		0.01	0.1	%/V
Load Regulation	ΔV _{Load}	V _{OUT} =2.8V, I _{OUT} =1~300mA		10	30	mV
Quiescent Current	I _Q	V _{OUT} =2.8V, I _{OUT} =0		42	70	μA
Short Current	I _{SHORT}	V _{EN} =V _{IN} , V _{OUT} Short to GND with 1Ω		80		mA
Shut-down Current	I _{SHDN}	V _{EN} =0V			1.0	μA
Power Supply Rejection Rate	PSRR	V _{IN} =(V _{OUT} +1V) _{DC} +0.5V _{P-P} F=217Hz, I _{OUT} =10mA		70		dB
		V _{IN} =(V _{OUT} +1V) _{DC} +0.5V _{P-P} F=10KHz, I _{OUT} =10mA		60		
EN logic high voltage	V _{ENH}	V _{IN} =5.5V, I _{OUT} =1mA	1.2			V
EN logic low voltage	V _{ENL}	V _{IN} =5.5V, V _{OUT} =0V			0.4	V
EN Input Current	I _{EN}	V _{EN} = 0 to 5.5V			1.0	μA
Output Noise Voltage	e _{NO}	10Hz to 100KHz, C _{OUT} =1μF		55		μV _{RMS}
Thermal shutdown threshold	T _{SD}			165		°C
Thermal shutdown hysteresis	Δ T _{SD}			30		°C

Typical characteristics ($T_a=25^\circ\text{C}$, $V_{IN}=3.8\text{V}$, $V_{OUT}=2.8\text{V}$, $C_{IN}=C_{OUT}=1\mu\text{F}$, unless otherwise noted)

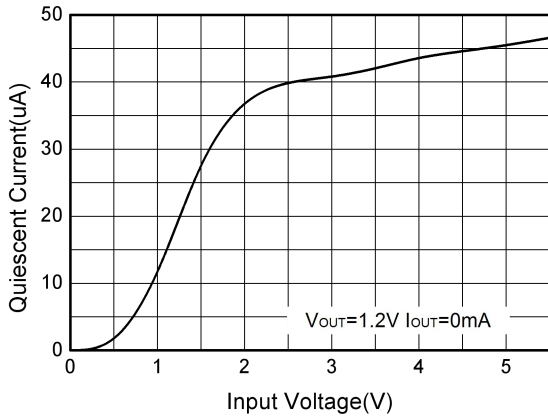

Quiescent current vs. Supply voltage

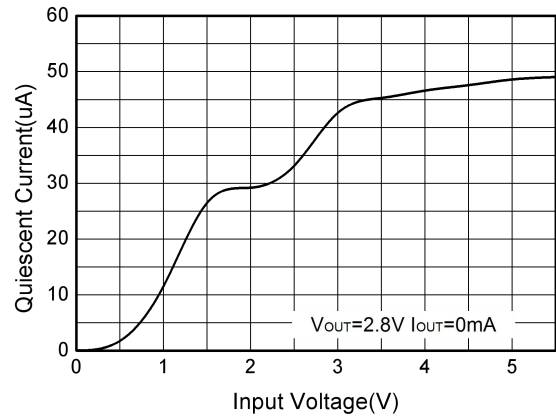

Quiescent current vs. Supply voltage

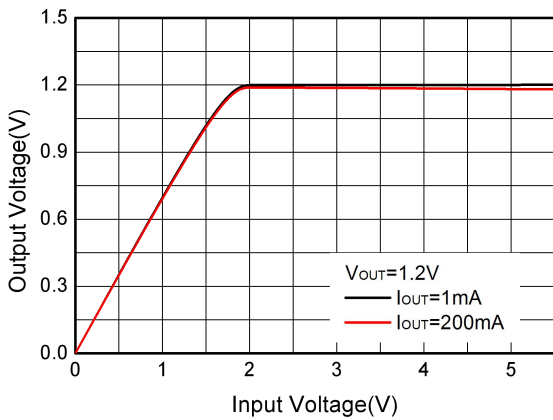

Output voltage vs. Supply voltage

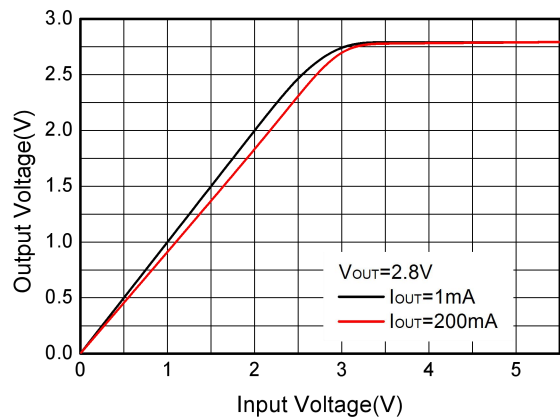

Output voltage vs. Supply voltage

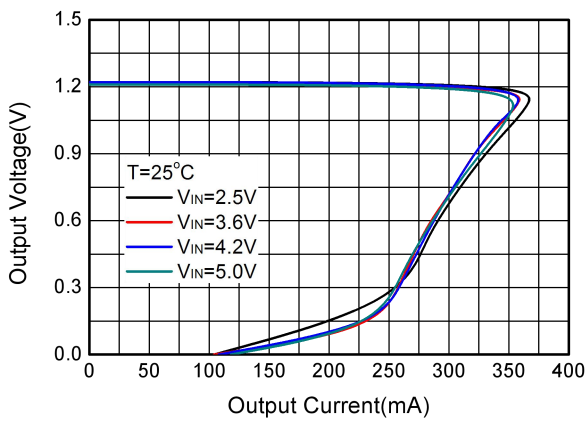

Output voltage vs. Output current

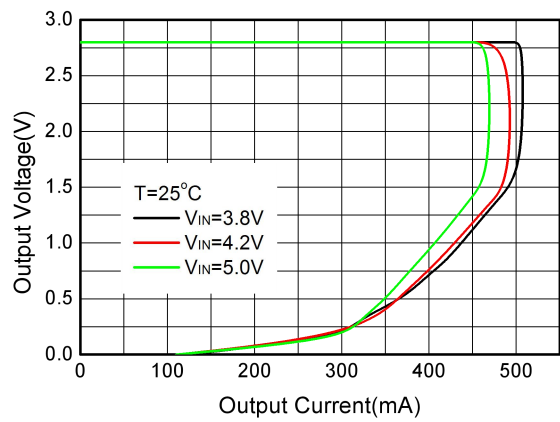

Output voltage vs. Output current

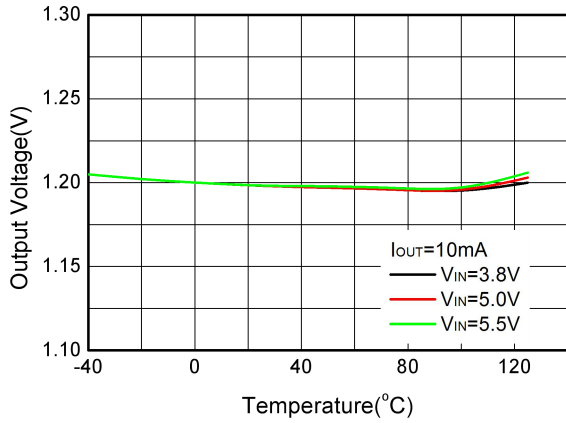
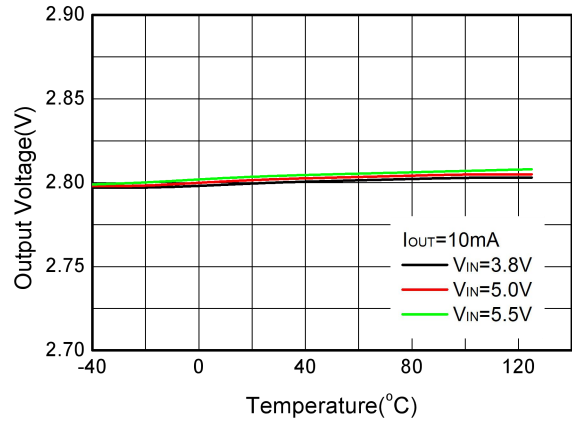
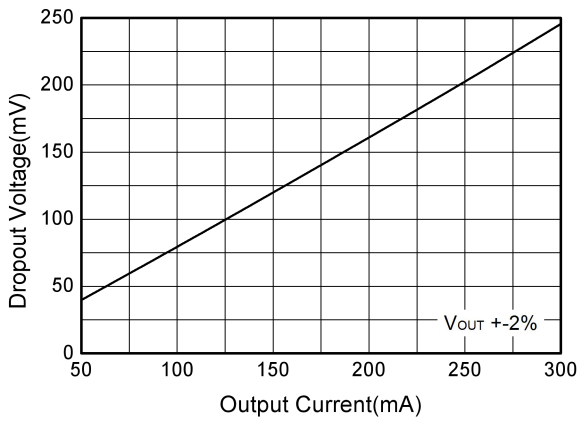
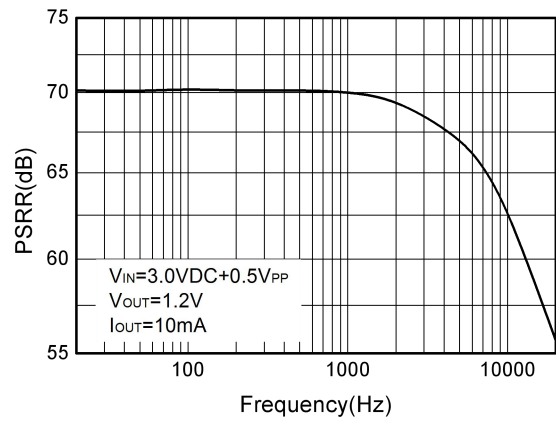
Output Voltage vs. Temperature

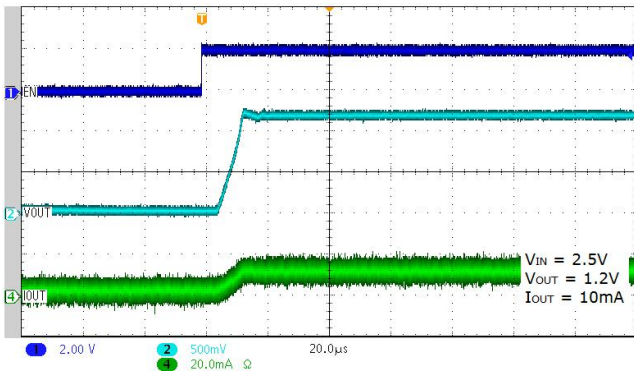
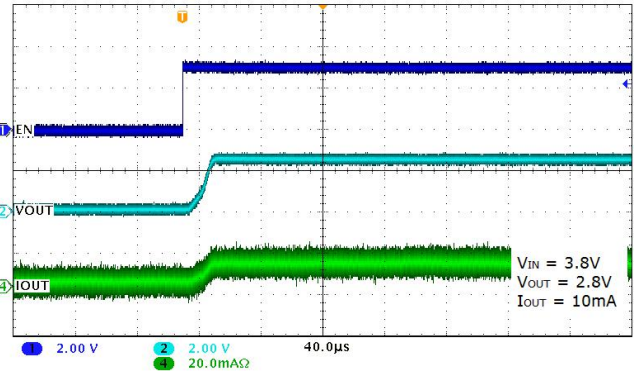
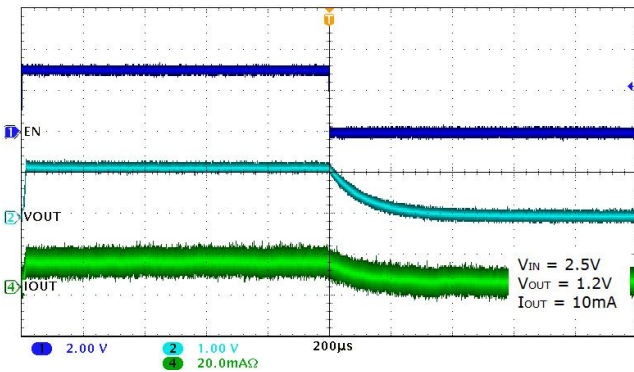
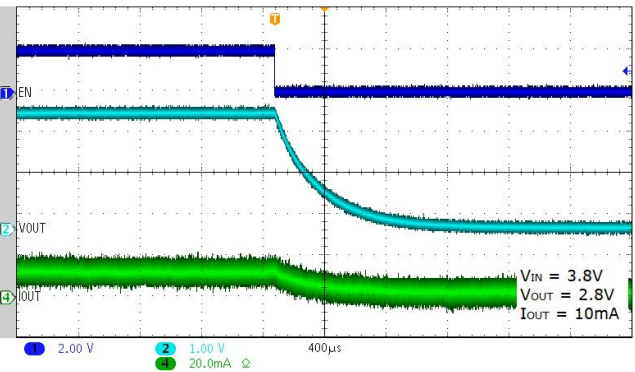
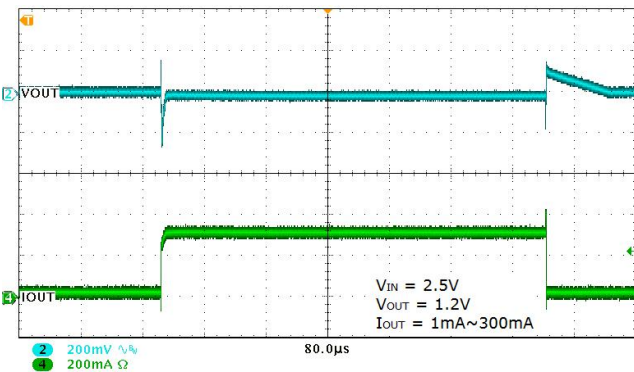
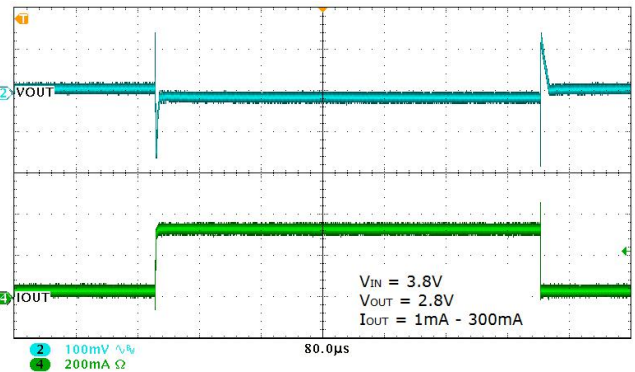
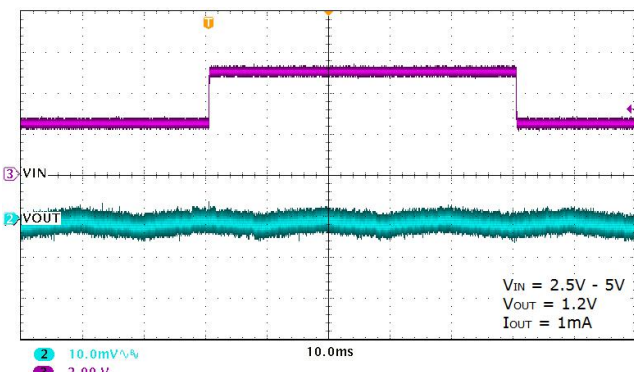
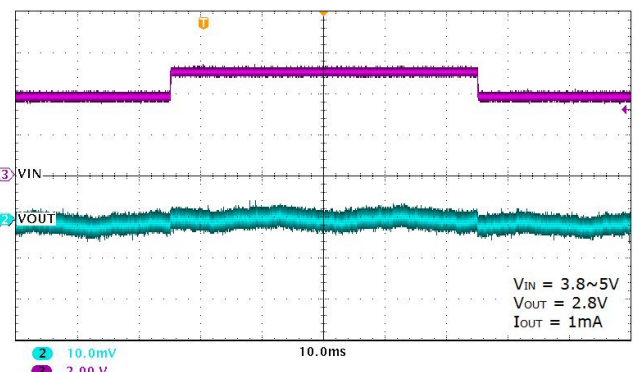
Output Voltage vs. Temperature

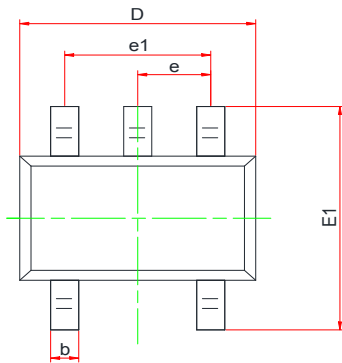
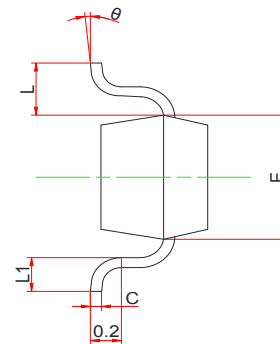
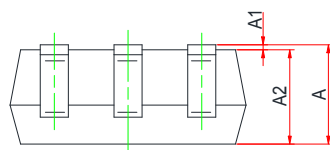
Dropout Voltage vs. Output Current

PSRR

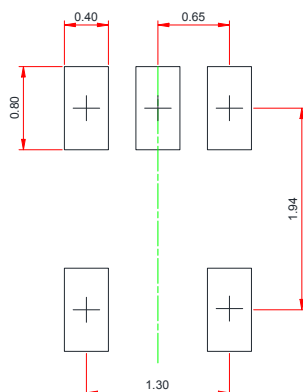

Soft Start form EN

Soft Start form EN

EN Shutdown

EN Shutdown

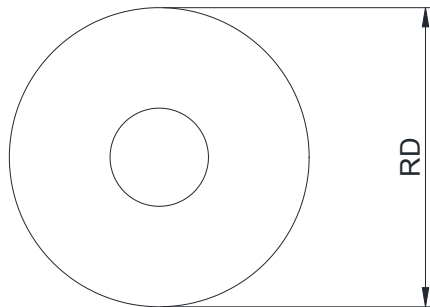
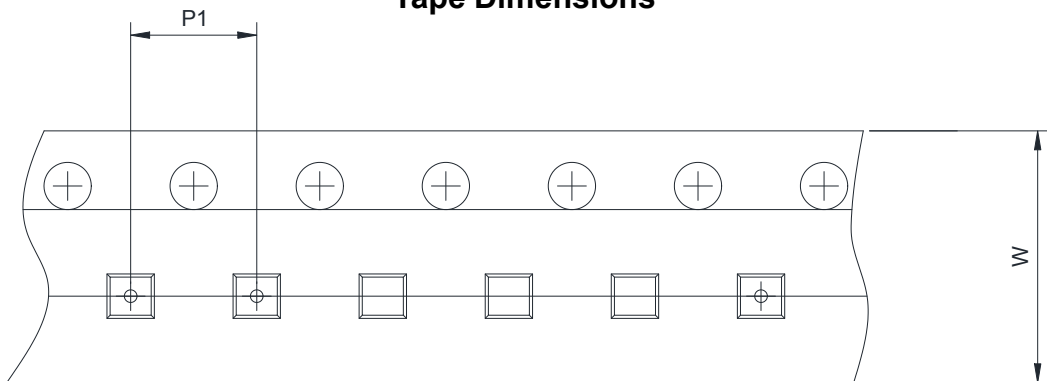
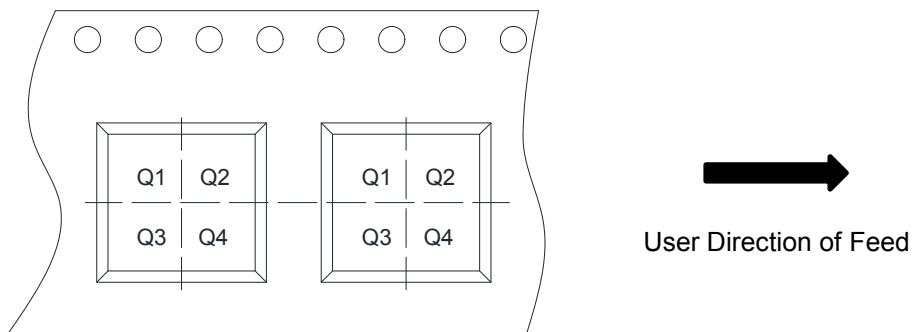
Load Step

Load Step

Line Step

Line Step

PACKAGE OUTLINE DIMENSIONS
SOT-353

TOP VIEW

SIDE VIEW

SIDE VIEW

Symbol	Dimensions in Millimeters		
	Min.	Typ.	Max.
A	0.85	-	1.10
A1	0.00	-	0.10
A2	0.80	0.90	1.00
b	0.15	0.25	0.35
c	0.08	-	0.15
D	2.00	2.10	2.20
E	1.15	1.25	1.35
E1	2.15	2.30	2.45
e	0.65 Typ.		
e1	1.20	1.30	1.40
L	0.50 Ref.		
L1	0.26	0.36	0.46
θ	0 °	-	8 °

Recommend PCB Layout (Unit: mm)

Notes:

This recommended land pattern is for reference purposes only. Please consult your manufacturing group to ensure your PCB design guidelines are met.

TAPE AND REEL INFORMATION
Reel Dimensions

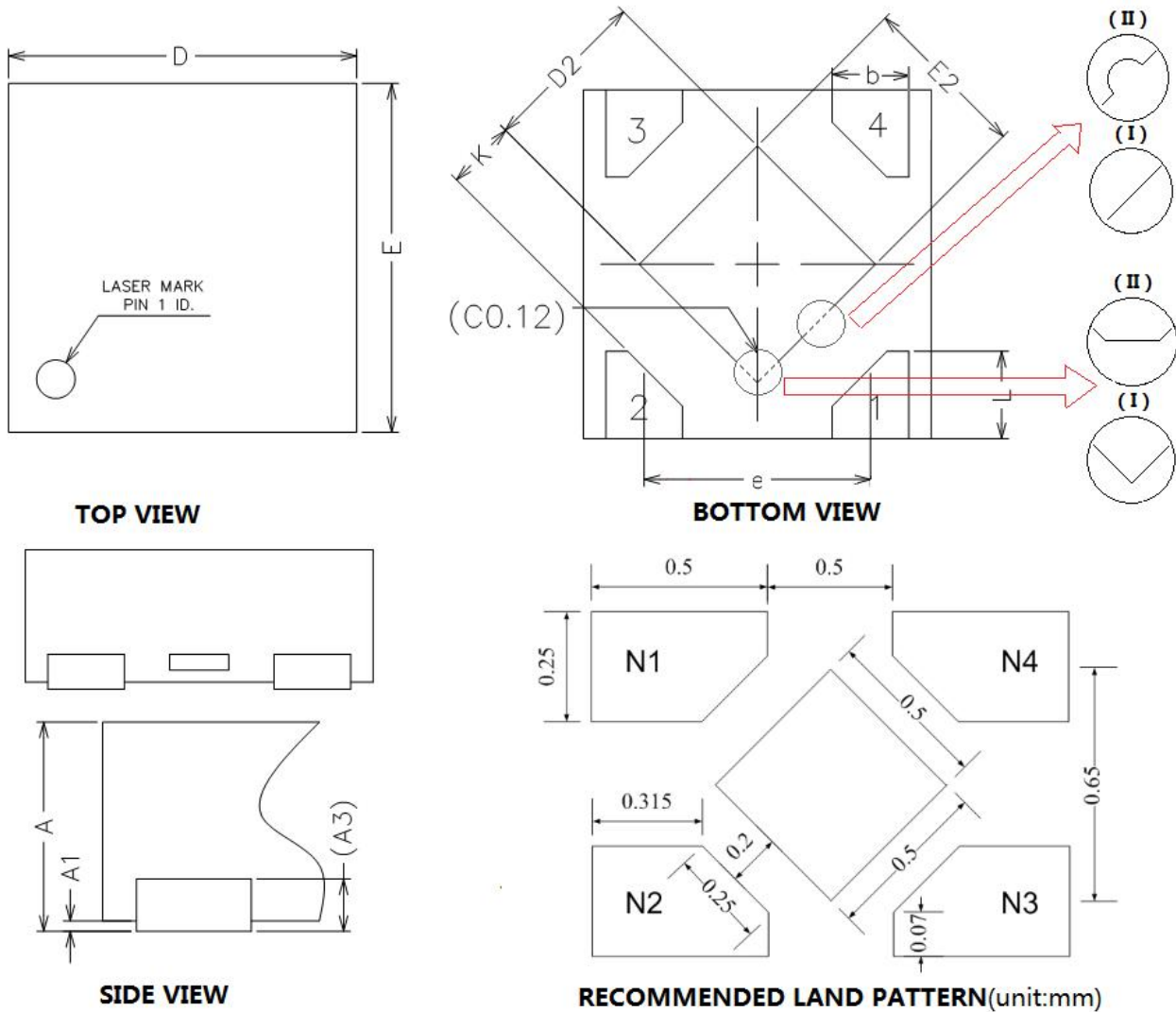
Tape Dimensions

Quadrant Assignments For PIN1 Orientation In Tape

RD	Reel Dimension	<input checked="" type="checkbox"/> 7inch	<input type="checkbox"/> 13inch		
W	Overall width of the carrier tape	<input checked="" type="checkbox"/> 8mm	<input type="checkbox"/> 12mm		
P1	Pitch between successive cavity centers	<input type="checkbox"/> 2mm	<input checked="" type="checkbox"/> 4mm	<input type="checkbox"/> 8mm	
Pin1	Pin1 Quadrant	<input type="checkbox"/> Q1	<input type="checkbox"/> Q2	<input checked="" type="checkbox"/> Q3	<input type="checkbox"/> Q4

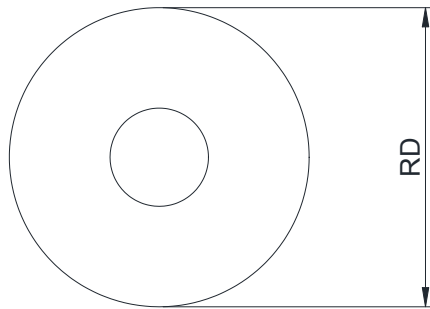
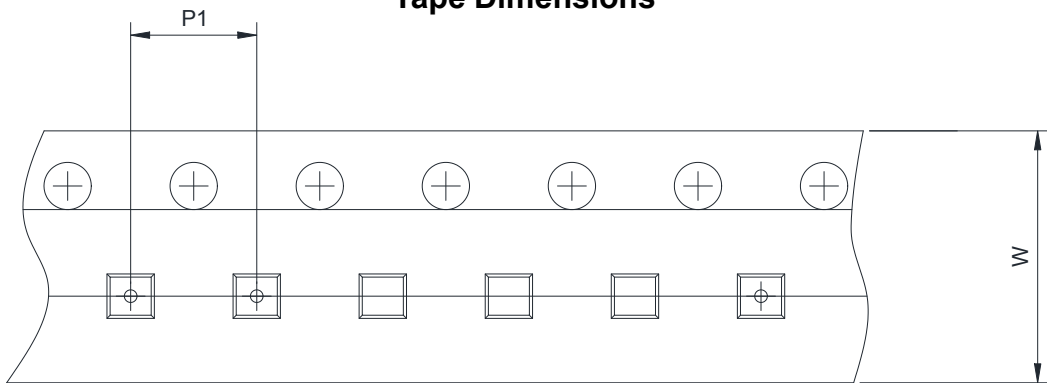
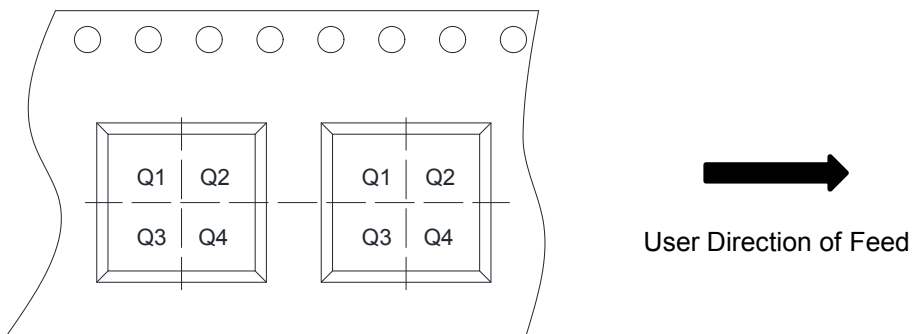
Packaging Information
DFN1x1-4L

Symbol	Dimensions In Millimeters		
	Min.	Typ.	Max.
A	0.34	0.37	0.40
A1	0.00	0.02	0.105
A3	0.10 REF		
b	0.17	0.22	0.27
D	0.95	1.00	1.05
E	0.95	1.00	1.05
D2	0.43	0.48	0.53
E2	0.43	0.48	0.53
L	0.20	0.25	0.30
e	0.60	0.65	0.70
K	0.15	-	-

TAPE AND REEL INFORMATION
Reel Dimensions

Tape Dimensions

Quadrant Assignments For PIN1 Orientation In Tape

RD	Reel Dimension	<input checked="" type="checkbox"/> 7inch	<input type="checkbox"/> 13inch
W	Overall width of the carrier tape	<input checked="" type="checkbox"/> 8mm	<input type="checkbox"/> 12mm <input type="checkbox"/> 16mm
P1	Pitch between successive cavity centers	<input checked="" type="checkbox"/> 2mm	<input type="checkbox"/> 4mm <input type="checkbox"/> 8mm
Pin1	Pin1 Quadrant	<input checked="" type="checkbox"/> Q1	<input type="checkbox"/> Q2 <input type="checkbox"/> Q3 <input type="checkbox"/> Q4

ORDER INFORMATION

Ordering No.	Vout (V)	Package	Operating Temperature	Marking	Shipping
WL2810B12-5/TR	1.2	SOT-353	-40~+85°C	BEM	Tape and Reel, 3000
WL2810B15-5/TR	1.5	SOT-353	-40~+85°C	BGM	Tape and Reel, 3000
WL2810B18-5/TR	1.8	SOT-353	-40~+85°C	BHM	Tape and Reel, 3000
WL2810B28-5/TR	2.8	SOT-353	-40~+85°C	BLM	Tape and Reel, 3000
WL2810B30-5/TR	3.0	SOT-353	-40~+85°C	BMM	Tape and Reel, 3000
WL2810B33-5/TR	3.3	SOT-353	-40~+85°C	BNM	Tape and Reel, 3000
WL2810D10-4/TR	1.0	DFN1x1-4L	-40~+85°C	DB YW	Tape and Reel, 10000
WL2810D105-4/TR	1.05	DFN1x1-4L	-40~+85°C	DC YW	Tape and Reel, 10000
WL2810D12-4/TR	1.2	DFN1x1-4L	-40~+85°C	DE YW	Tape and Reel, 10000
WL2810D13-4/TR	1.3	DFN1x1-4L	-40~+85°C	DF YW	Tape and Reel, 10000
WL2810D15-4/TR	1.5	DFN1x1-4L	-40~+85°C	DG YW	Tape and Reel, 10000
WL2810D18-4/TR	1.8	DFN1x1-4L	-40~+85°C	DH YW	Tape and Reel, 10000
WL2810D25-4/TR	2.5	DFN1x1-4L	-40~+85°C	DK YW	Tape and Reel, 10000
WL2810D28-4/TR	2.8	DFN1x1-4L	-40~+85°C	DL YW	Tape and Reel, 10000
WL2810D30-4/TR	3.0	DFN1x1-4L	-40~+85°C	DM YW	Tape and Reel, 10000
WL2810D33-4/TR	3.3	DFN1x1-4L	-40~+85°C	DN YW	Tape and Reel, 10000

Marking:

- B*** = Device Code
- D*** = Device Code
- M** = Month
- Y** = Year
- W** = Week

X-ON Electronics

Largest Supplier of Electrical and Electronic Components

Click to view similar products for [Linear Voltage Regulators](#) category:

Click to view products by [Will Semiconductor](#) manufacturer:

Other Similar products are found below :

[LV56831P-E](#) [LV5684PVD-XH](#) [MCDTSA6-2R](#) [L7815ACV-DG](#) [PQ3DZ53U](#) [LV56801P-E](#) [L78L05CZ/1SX](#) [L78LR05DL-MA-E](#) [636416C](#)
[714954EB](#) [LV5680P-E](#) [L78M15CV-DG](#) [L79M05T-E](#) [MIC5283-5.0YML-T5](#) [TLS202A1MBVHTSA1](#) [L78LR05D-MA-E](#) [NCV317MBTG](#)
[NTE7227](#) [MP2018GZD-33-P](#) [MP2018GZD-5-P](#) [LV5680NPVC-XH](#) [LT1054CN8](#) [MP2018GZD-5-Z](#) [MP2018GZD-33-Z](#) [AT55EL50ESE](#)
[APL5934DKAI-TRG](#) [CL9193A15L5M](#) [CL9036A30F4M](#) [CL9036A18F4M](#) [CL9036A25F4M](#) [CL9036A28F4M](#) [CL9036A33F4M](#)
[CL9906A18F4N](#) [CL9906A30F4N](#) [CL9908A30F4M](#) [CL9908A33F4M](#) [CL9908A18F4M](#) [CL9908A28F4M](#) [TL431ACM/TR](#) [TL431AIM/TR](#)
[LM78L05ACM/TR](#) [HT7812ARMZ](#) [HT7805ARMZ](#) [HXY6206I-3.0](#) [HXY6206I-3.3](#) [XC6206P252MR](#) [XC6206P282MR](#) [XC6206P302MR](#)
[XC6206P332MR](#) [CJ6211B12F](#)