

WL2820D

Low noise, High PSRR, High speed, CMOS LDO

[Http://www.sh-willsemi.com](http://www.sh-willsemi.com)

Descriptions

The WL2820D series is a high accuracy, low noise, high speed, low dropout CMOS Linear regulator with high ripple rejection. The devices offer a new level of cost effective performance in cellular phones, laptop and notebook computers, and other portable devices.

The WL2820D has the fold-back maximum output current which depends on the output voltage. So the current limit functions both as a short circuit protection and as an output current limiter.

The WL2820D regulators are available in standard DFN1x1-4L Package. Standard products are Pb-free and Halogen-free.



DFN1X1-4L

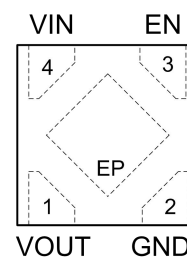

Pin Configuration (Top View)

Features

- Input voltage : 2.2V~5.5V
- Output range : 1.0V~3.8V
- Output current : 300mA
- PSRR : 70dB @ 217Hz
- Dropout voltage : 250mV @ I_{OUT}=300mA
- Quiescent current : 42μA Typ.
- Shut-down current : < 1μA
- Discharge Resistance : 100Ω
- Recommend capacitor : 1uF

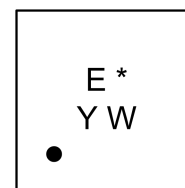

E: Package Code

*** : Voltage Code**

Y : Year Code

W: Week Code

For detail marking information, please see page 8.

Marking

Applications

- MP3/MP4 Players
- Cellphones, radiophone, digital cameras
- Bluetooth, wireless handsets
- Others portable electronics device

Order Information

For detail order information, please see page 8.

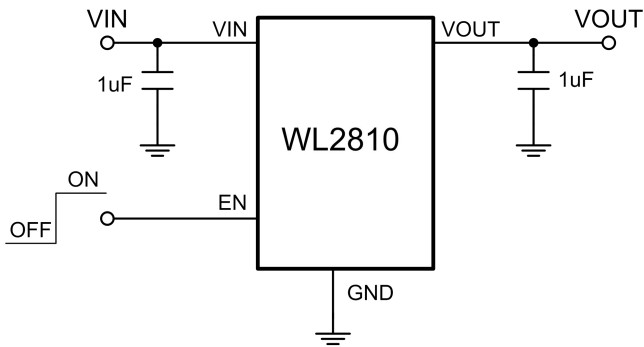
Typical Application

Pin Description
DFN1X1-4L

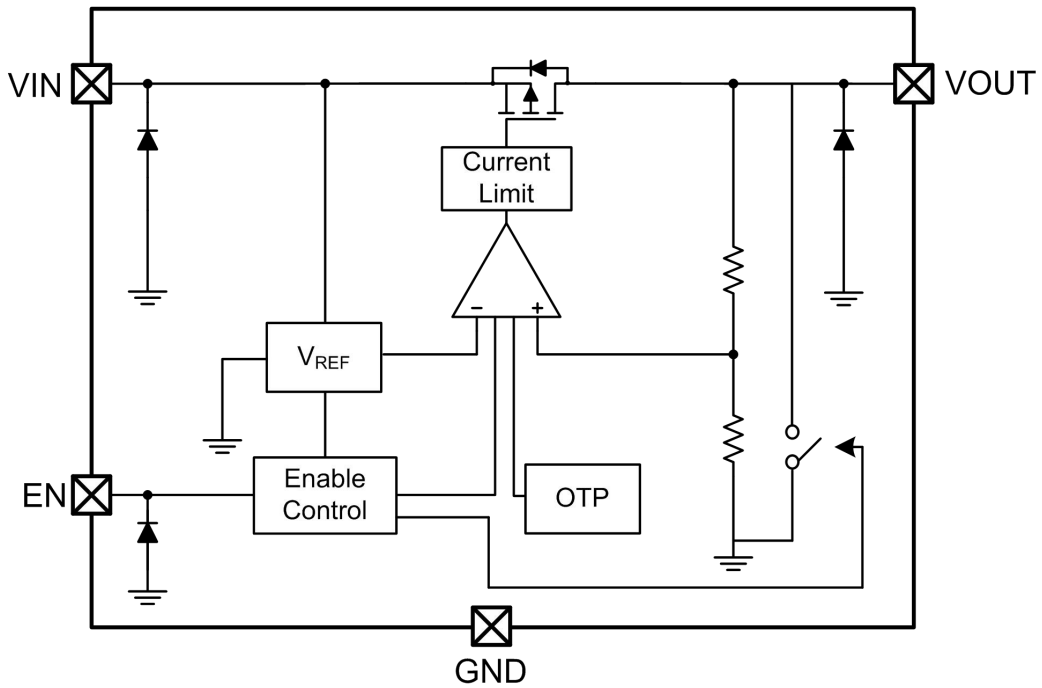
PIN	Symbol	Description
1	VOUT	Output
2	GND	Ground
3	EN	Enable (Active high)
4	VIN	Input
EP		GND level, this pin must connect to GND.

Block Diagram

Absolute Maximum Ratings

Parameter	Value	Unit	
Power Dissipation, $P_D@T_A=25^\circ\text{C}$	400	mW	
V_{IN} Range	-0.3~6.5	V	
V_{EN} Range	-0.3~ V_{IN}	V	
V_{OUT} Range	-0.3~ V_{IN}	V	
I_{OUT}	Internally Limited		
Lead Temperature Range	260	$^\circ\text{C}$	
Storage Temperature Range	-55 ~ 150	$^\circ\text{C}$	
Operating Junction Temperature Range	150	$^\circ\text{C}$	
ESD Ratings	HBM	8000	V
	MM	400	V

Recommend Operating Ratings

Parameter	Value	Unit
Operating Supply voltage	2.2~5.5	V
Operating Temperature Range	-40~85	$^\circ\text{C}$
Thermal Resistance, $R_{\theta JA}$	250	$^\circ\text{C/W}$

Electronics Characteristics (Ta=25°C, V_{IN}=V_{OUT}+1V, C_{IN}=C_{OUT}=1μF, unless otherwise noted)

Parameter	Symbol	Condition	Min.	Typ.	Max.	Unit
Output Voltage	V _{OUT}	V _{OUT} ≤ 1.5V, V _{IN} =2.7V, I _{OUT} =1mA	0.97 V _{OUT}	V _{OUT}	1.03 V _{OUT}	V
		V _{OUT} > 1.5V, I _{OUT} =1mA	0.98 V _{OUT}	V _{OUT}	1.02 V _{OUT}	
Current Limit	I _{LIM}	V _{EN} =V _{IN}	300			mA
Dropout Voltage	V _{DROP}	V _{OUT} =3.3V, I _{OUT} =300mA		220	330	mV
		V _{OUT} =3.0V, I _{OUT} =300mA		240	360	
		V _{OUT} =2.8V, I _{OUT} =300mA		250	375	
		V _{OUT} =2.5V, I _{OUT} =300mA		280	420	
		V _{OUT} =1.8V, I _{OUT} =300mA		400	600	
		V _{OUT} ≤ 1.5V, I _{OUT} =300mA	V _{in-min} =2.2V			
Line Regulation	ΔV _{LINE}	V _{IN} =2.7~5.5V, I _{OUT} =1mA		0.01	0.1	%/V
Load Regulation	ΔV _{Load}	V _{OUT} =2.8V, I _{OUT} =1~300mA		10	30	mV
Quiescent Current	I _Q	V _{OUT} =2.8V, I _{OUT} =0		42	70	μA
Short Current	I _{SHORT}	V _{EN} =V _{IN} , V _{OUT} Short to GND with 1Ω		80		mA
Shut-down Current	I _{SHDN}	V _{EN} =0V			1.0	μA
Power Supply Rejection Rate	PSRR	V _{IN} =(V _{OUT} +1V) _{DC} +0.5V _{P-P} F=217Hz, I _{OUT} =10mA		70		dB
		V _{IN} =(V _{OUT} +1V) _{DC} +0.5V _{P-P} F=10KHz, I _{OUT} =10mA		60		
EN logic high voltage	V _{ENH}	V _{IN} =5.5V, I _{OUT} =1mA	1.2			V
EN logic low voltage	V _{ENL}	V _{IN} =5.5V, V _{OUT} =0V			0.4	V
EN Input Current	I _{EN}	V _{EN} = 0 to 5.5V			1.0	μA
Output Noise Voltage	e _{NO}	10Hz to 100KHz, C _{OUT} =1μF		55		μV _{RMS}
Thermal shutdown threshold	T _{SD}			165		°C
Thermal shutdown hysteresis	Δ T _{SD}			30		°C
Auto-discharge Nch Tr. ON Resistance	R _{LOW}	V _{IN} =4.0V, V _{CE} =0V		100		Ω

Typical characteristics ($T_a=25^\circ\text{C}$, $V_{IN}=3.8\text{V}$, $V_{OUT}=2.8\text{V}$, $C_{IN}=C_{OUT}=1\mu\text{F}$, unless otherwise noted)

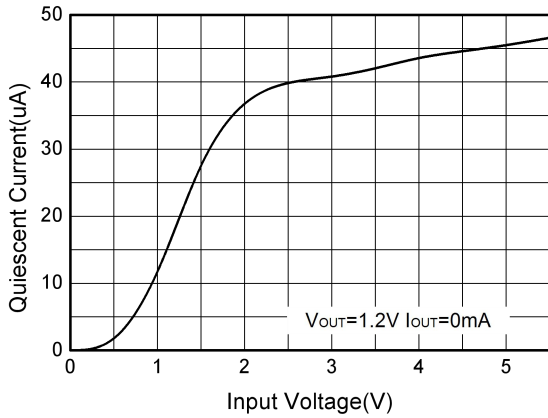

Quiescent current vs. Supply voltage

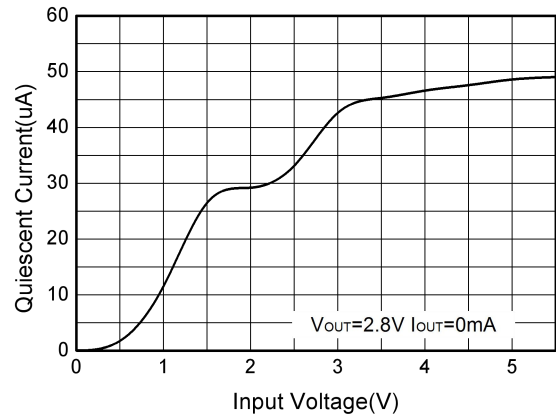

Quiescent current vs. Supply voltage

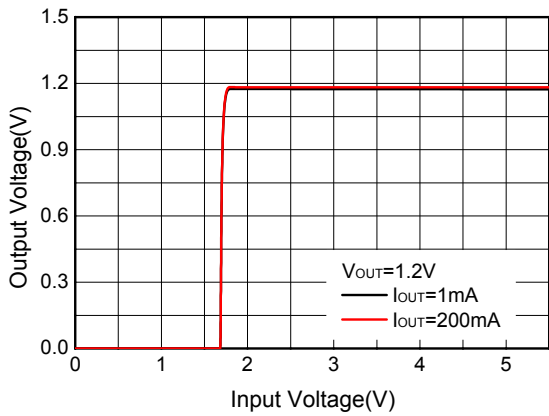

Output voltage vs. Supply voltage

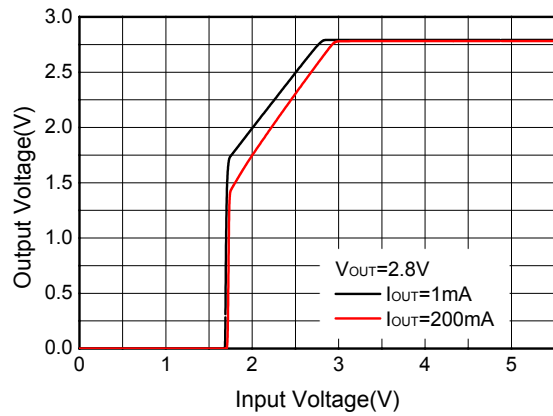

Output voltage vs. Supply voltage

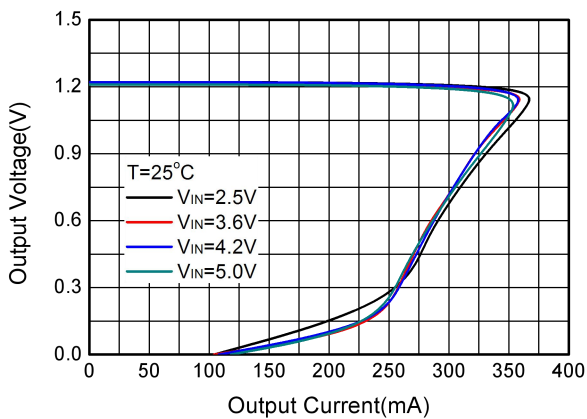

Output voltage vs. Output current

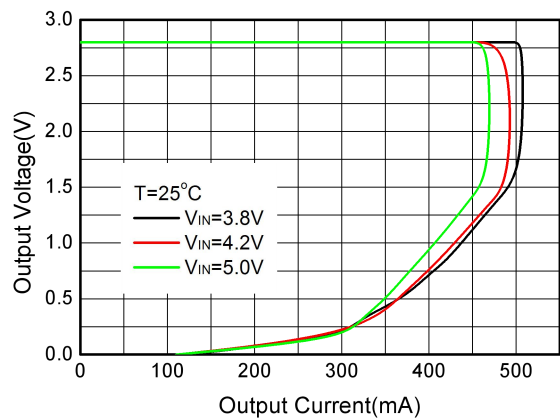

Output voltage vs. Output current

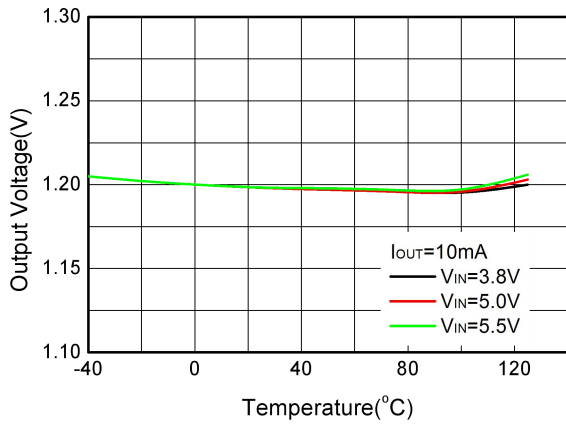
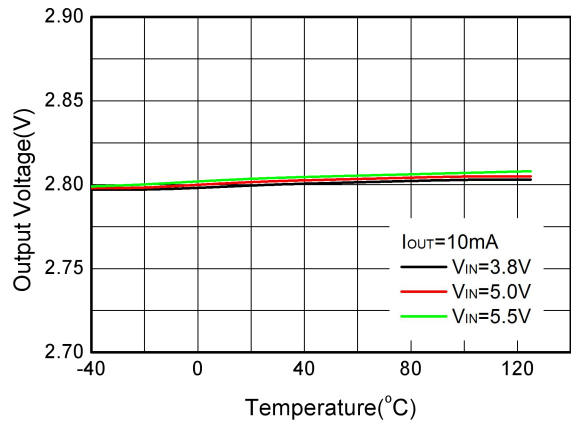
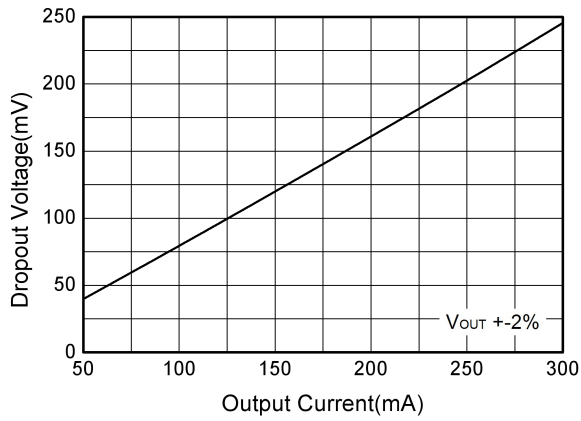
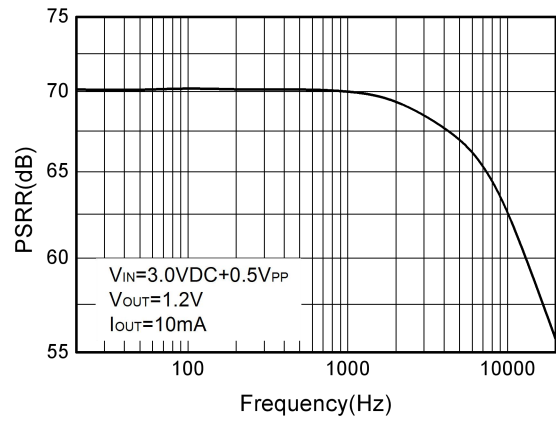
Output Voltage vs. Temperature

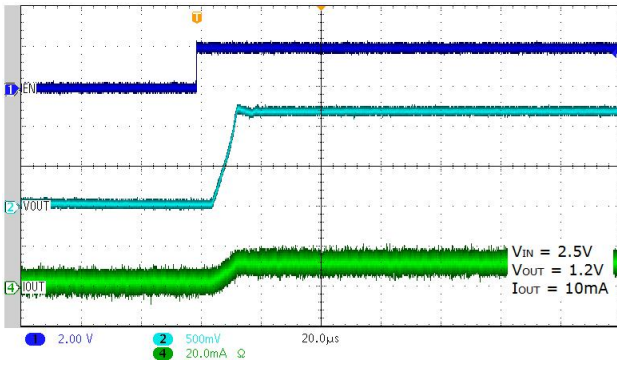
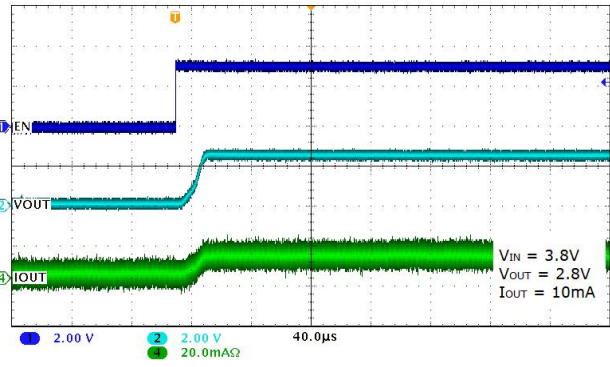
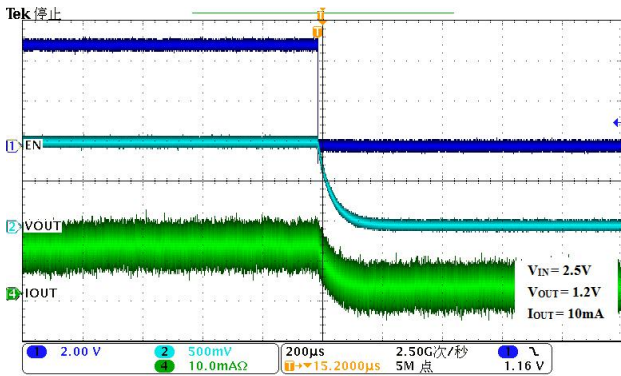
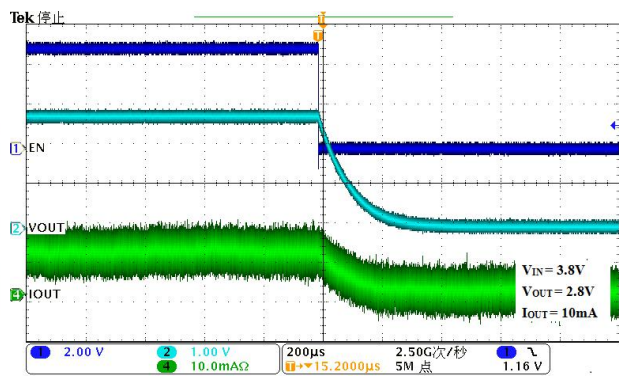
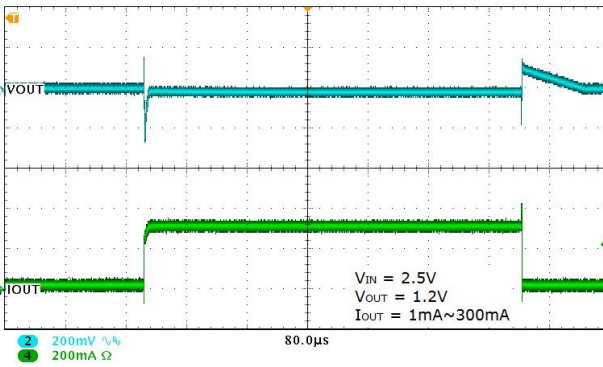
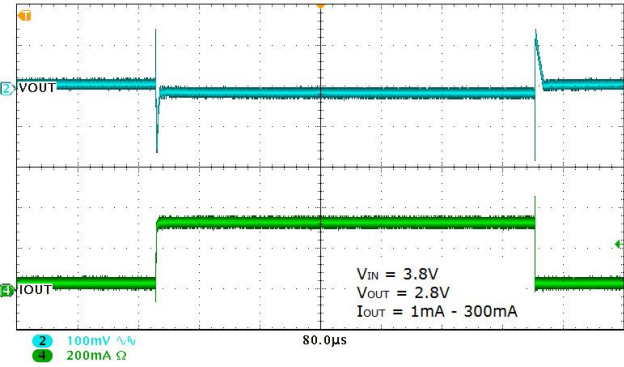
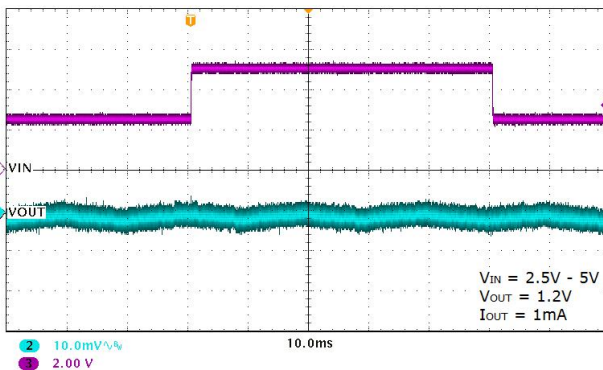
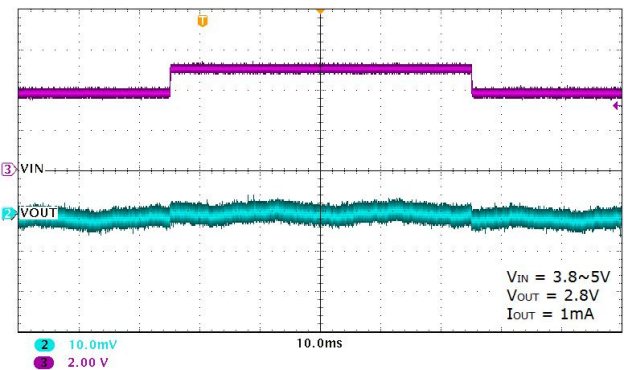
Output Voltage vs. Temperature

Dropout Voltage vs. Output Current

PSRR

Soft Start form EN

Soft Start form EN

EN Shutdown

EN Shutdown

Load Step

Load Step

Line Step

Line Step

ORDER INFORMATION

Ordering No.	Vout (V)	Package	Operating Temperature	Marking	Shipping
WL2820D105-4/TR	1.05	DFN1x1-4L	-40~+85°C	EC YW	Tape and Reel, 10000
WL2820D11-4/TR	1.1	DFN1x1-4L	-40~+85°C	ED YW	Tape and Reel, 10000
WL2820D12-4/TR	1.2	DFN1x1-4L	-40~+85°C	EE YW	Tape and Reel, 10000
WL2820D15-4/TR	1.5	DFN1x1-4L	-40~+85°C	EG YW	Tape and Reel, 10000
WL2820D18-4/TR	1.8	DFN1x1-4L	-40~+85°C	EH YW	Tape and Reel, 10000
WL2820D21-4/TR	2.1	DFN1x1-4L	-40~+85°C	EX YW	Tape and Reel, 10000
WL2820D22-4/TR	2.2	DFN1x1-4L	-40~+85°C	EJ YW	Tape and Reel, 10000
WL2820D25-4/TR	2.5	DFN1x1-4L	-40~+85°C	EK YW	Tape and Reel, 10000
WL2820D27-4/TR	2.7	DFN1x1-4L	-40~+85°C	EY YW	Tape and Reel, 10000
WL2820D28-4/TR	2.8	DFN1x1-4L	-40~+85°C	EL YW	Tape and Reel, 10000
WL2820D285-4/TR	2.85	DFN1x1-4L	-40~+85°C	EV YW	Tape and Reel, 10000
WL2820D30-4/TR	3.0	DFN1x1-4L	-40~+85°C	EM YW	Tape and Reel, 10000
WL2820D33-4/TR	3.3	DFN1x1-4L	-40~+85°C	EN YW	Tape and Reel, 10000
WL2820D38-4/TR	3.8	DFN1x1-4L	-40~+85°C	EQ YW	Tape and Reel, 10000

Marking:

E* = Device Code

Y = Year

W = Week

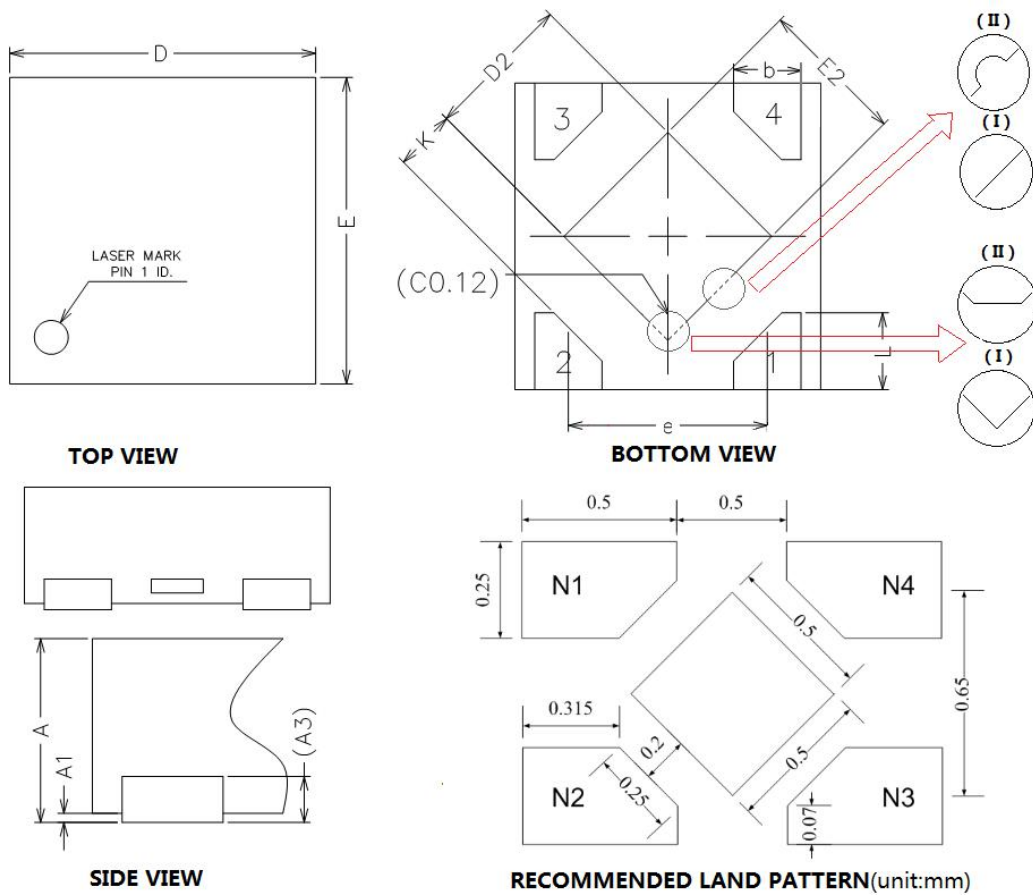
PACKAGE OUTLINE DIMENSIONS
DFN1x1-4L

Symbol	Dimensions In Millimeters		
	Min.	Typ.	Max.
A	0.34	0.37	0.40
A1	0.00	0.02	0.105
A3	0.10 REF		
b	0.17	0.22	0.27
D	0.95	1.00	1.05
E	0.95	1.00	1.05
D2	0.43	0.48	0.53
E2	0.43	0.48	0.53
L	0.20	0.25	0.30
e	0.60	0.65	0.70
K	0.15	-	-

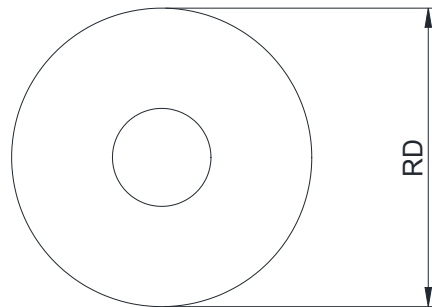
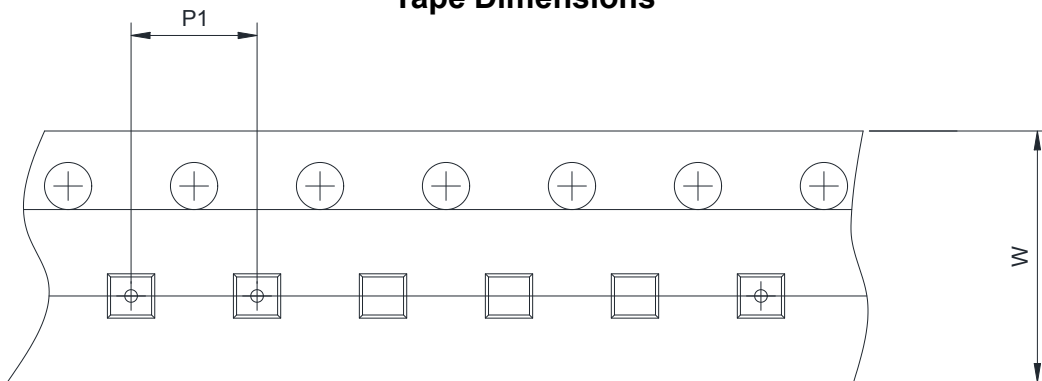
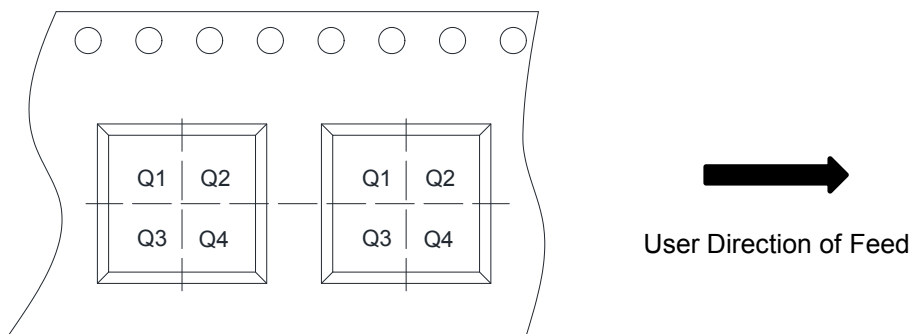
TAPE AND REEL INFORMATION
Reel Dimensions

Tape Dimensions

Quadrant Assignments For PIN1 Orientation In Tape

RD	Reel Dimension	<input checked="" type="checkbox"/> 7inch	<input type="checkbox"/> 13inch
W	Overall width of the carrier tape	<input checked="" type="checkbox"/> 8mm	<input type="checkbox"/> 12mm <input type="checkbox"/> 16mm
P1	Pitch between successive cavity centers	<input checked="" type="checkbox"/> 2mm	<input type="checkbox"/> 4mm <input type="checkbox"/> 8mm
Pin1	Pin1 Quadrant	<input checked="" type="checkbox"/> Q1	<input type="checkbox"/> Q2 <input type="checkbox"/> Q3 <input type="checkbox"/> Q4

X-ON Electronics

Largest Supplier of Electrical and Electronic Components

Click to view similar products for [Linear Voltage Regulators](#) category:

Click to view products by [Will Semiconductor](#) manufacturer:

Other Similar products are found below :

[LV56831P-E](#) [LV5684PVD-XH](#) [MCDTSA6-2R](#) [L7815ACV-DG](#) [PQ3DZ53U](#) [LV56801P-E](#) [TLE42794G](#) [L78L05CZ/1SX](#) [L78LR05DL-MA-E](#) [636416C](#) [714954EB](#) [ZMR500QFTA](#) [LV5680P-E](#) [L78M15CV-DG](#) [L79M05T-E](#) [TLS202A1MBVHTSA1](#) [L78LR05D-MA-E](#) [NCV317MBTG](#) [NTE7227](#) [MP2018GZD-33-P](#) [MP2018GZD-5-P](#) [LV5680NPVC-XH](#) [LT1054CN8](#) [MP2018GZD-5-Z](#) [MP2018GZD-33-Z](#) [AT55EL50ESE](#) [APL5934DKAI-TRG](#) [78L05U](#) [78L05](#) [CL9036A30F4M](#) [CL9036A18F4M](#) [CL9036A25F4M](#) [CL9036A28F4M](#) [CL9036A33F4M](#) [CL9906A18F4N](#) [CL9906A30F4N](#) [CL9908A30F4M](#) [CL9908A33F4M](#) [CL9908A18F4M](#) [CL9908A28F4M](#) [TL431ACM/TR](#) [TL431AIM/TR](#) [LM78L05ACM/TR](#) [HT7812ARMZ](#) [HT7805ARMZ](#) [HT317LRHZ](#) [HXY6206I-3.0](#) [HXY6206I-3.3](#) [XC6206P252MR](#) [XC6206P282MR](#) [XC6206P302MR](#)