

WL2836D

Low noise, High PSRR, High speed, CMOS LDO

[Http://www.sh-willsemi.com](http://www.sh-willsemi.com)

Descriptions

The WL2836D series is a high accuracy, low noise, high speed, high PSRR, low dropout CMOS Linear regulator with high ripple rejection. The devices offer a new level of cost effective performance in cellular phones, laptop and notebook computers, and other portable devices.

The WL2836D has the fold-back maximum output current which depends on the output voltage. So the current limit functions both as a short circuit protection and as an output current limiter.

The WL2836D regulators are available in standard DFN1x1-4L Package. Standard products are Pb-free and Halogen-free.

Features

- Input Voltage Range : 1.4V~5.5V
- Output Voltage Range : 0.9V~3.3V
- Output current : 300mA
- Quiescent current : 50μA Typ.
- Shut-down current : < 1μA
- Dropout voltage : 140mV @ I_{OUT}=0.3A
- PSRR : 78dB @ 1kHz, V_{OUT}=1.8V
- Low Output Voltage Noise : 13×V_{OUT} μV_{RMS}
- Output Voltage Tolerance : ±1% @ V_{OUT}>2V
- Recommend capacitor : 1μF
- Thermal-Overload and Short-Circuit Protection

Applications

- MP3/MP4 Players
- Cellphones, radiophone, digital cameras
- Bluetooth, wireless handsets
- Others portable electronics device



DFN1x1-4L

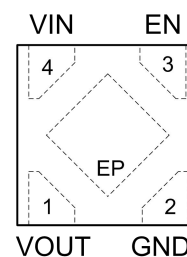

Pin Configuration (Top View)

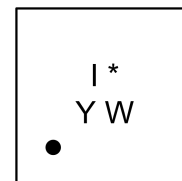

I : Device Code
***** : Voltage Code
Y : Year Code
W : Week Code

For detail marking information, please see page 14.

Marking

Order Information

For detail order information, please see page 14.

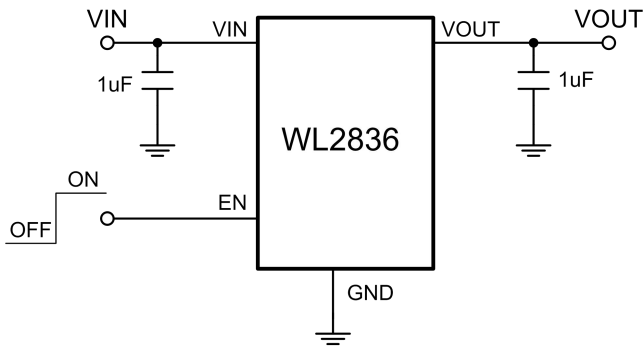
Typical Application

Pin Description
DFN1x1-4L

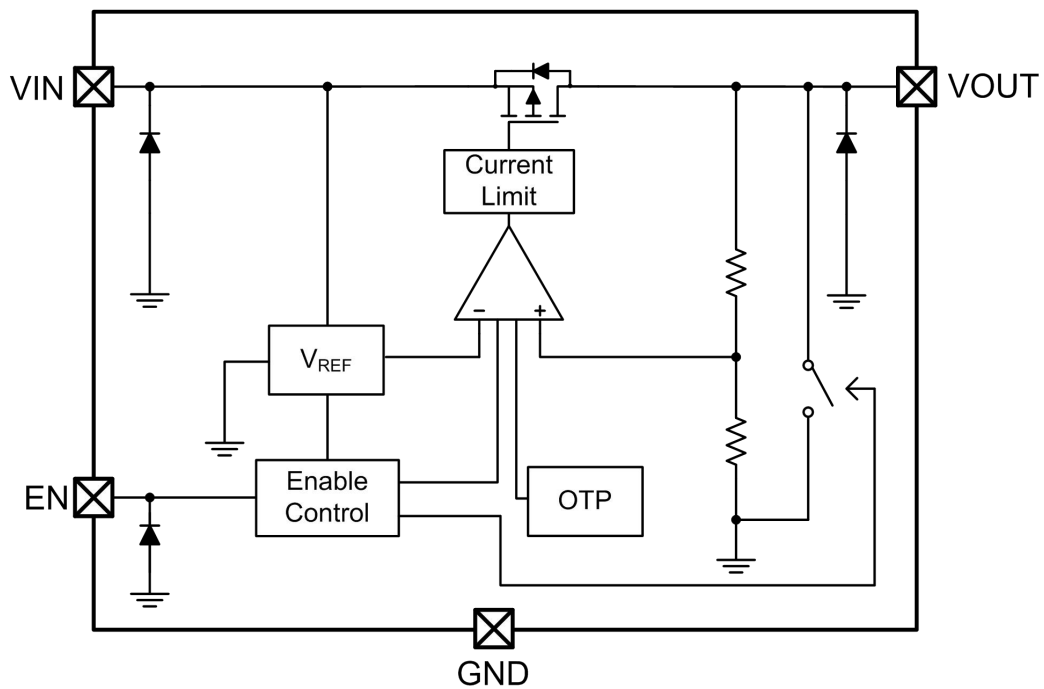
PIN	Symbol	Description
1	V _{OUT}	Output
2	GND	Ground
3	EN	Enable (Active high)
4	V _{IN}	Input
EP		GND level, this pin must connect to GND.

Block Diagram

Absolute Maximum Ratings

Parameter	Value	Unit	
Power Dissipation, $P_D@T_A=25^\circ\text{C}$	400	mW	
V_{IN} Range	-0.3~6.5	V	
V_{EN} Range	-0.3~ V_{IN}	V	
V_{OUT} Range	-0.3~ V_{IN}	V	
I_{OUT}	Internally Limited		
Lead Temperature Range	260	$^\circ\text{C}$	
Storage Temperature Range	-55 ~ 150	$^\circ\text{C}$	
Operating Junction Temperature Range	150	$^\circ\text{C}$	
MSL	Level-1		
ESD Ratings	HBM	7500	V
	MM	300	V

Recommend Operating Ratings

Parameter	Value	Unit
Operating Supply voltage	1.4~5.5	V
Operating Temperature Range	-40~85	$^\circ\text{C}$
Thermal Resistance, $R_{\theta JA}$ (DFN1x1-4L)	250	$^\circ\text{C/W}$

Electronics Characteristics
(Ta=25°C, V_{IN}=V_{OUT}+1V, C_{IN}=C_{OUT}=1 μ F, I_{OUT}=1mA, unless otherwise noted)

Parameter	Symbol	Condition	Min.	Typ.	Max.	Unit	
Output Voltage	V _{OUT}	V _{OUT} ≤ 2V	-20	V _{OUT}	+20	mV	
		V _{OUT} > 2V	0.99× V _{OUT}	V _{OUT}	1.01× V _{OUT}	V	
Input Voltage	V _{IN}		1.4		5.5	V	
Current Limit	I _{LIM}	V _{EN} =V _{IN}	300			mA	
Dropout Voltage	V _{DROP}	V _{OUT} =3.3V, I _{OUT} =300mA		118	185	mV	
		V _{OUT} =3V, I _{OUT} =300mA		122	192		
		V _{OUT} =2.8V, I _{OUT} =300mA		130	204		
		V _{OUT} =2.5V, I _{OUT} =300mA		140	220		
		V _{OUT} =1.6V, I _{OUT} =300mA		205	320		
		V _{OUT} =1V, I _{OUT} =300mA		370	555		
Line Regulation	ΔV _{LINE}	V _{IN} =V _{OUT} +0.5V~5.5V		1	5	mV	
Load Regulation	ΔV _{Load}	I _{OUT} =1~300mA		15	28	mV	
Quiescent Current	I _Q	V _{OUT} =2.8V, I _{OUT} =0		50	90	μA	
Short Current	I _{SHORT}	V _{EN} =V _{IN} , V _{OUT} Short to GND		120		mA	
Shut-down Current	I _{SHDN}	V _{EN} =0V			1.0	μA	
Power Supply Rejection Rate	PSRR	V _{IN} =(V _{OUT} +1V) _{DC} + 0.5V _{P-P} I _{OUT} =10mA, V _{OSET} =1.8V	f=100Hz		80		dB
			f=1kHz		78		dB
			f=10kHz		65		dB
			f=100kHz		56		dB
			f=1MHz		43		dB
EN logic high voltage	V _{ENH}	V _{IN} =5.5V, I _{OUT} =1mA	1			V	
EN logic low voltage	V _{ENL}	V _{IN} =5.5V, V _{OUT} =0V			0.4	V	
EN Input Current	I _{EN}	V _{EN} = 0 to 5.5V		120		nA	
Output Noise Voltage	e _{NO}	10Hz to 100KHz, C _{OUT} =1μF		13× V _{OUT}		μV _{RMS}	
Thermal shutdown threshold	T _{SD}			160		°C	
Thermal shutdown hysteresis	Δ T _{SD}			30		°C	
Auto-discharge Nch Tr, ON Resistance	R _{LOW}	V _{IN} =4V, V _{CE} =0V, V _{OUT} =2.8V		120		Ω	

Typical characteristics ($T_a=25^\circ\text{C}$, $V_{IN}=V_{OUT}+1\text{V}$, $I_{OUT}=1\text{mA}$, $C_{IN}=C_{OUT}=1\ \mu\text{F}$, unless otherwise noted)

$V_{OUT}=1.2\text{V}$

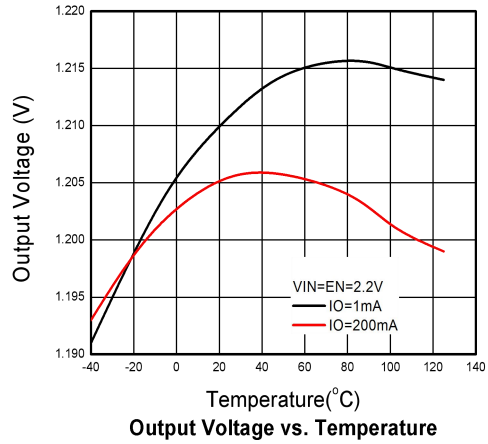
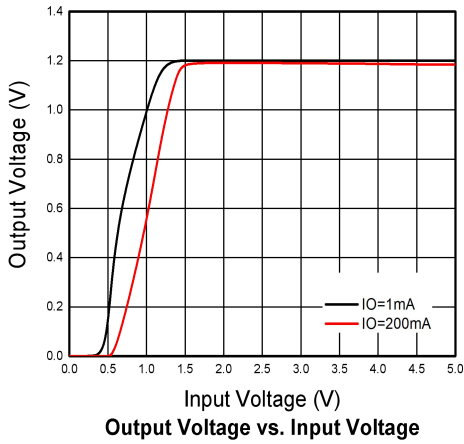

$V_{OUT}=1.8\text{V}$

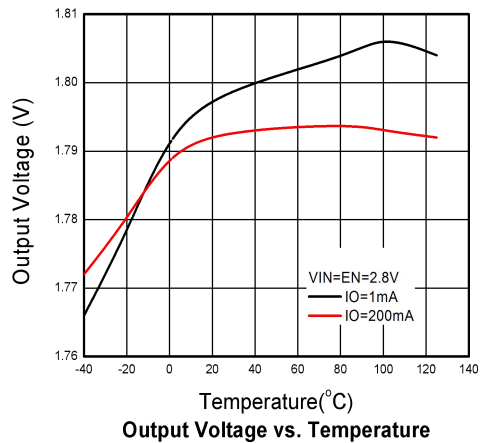
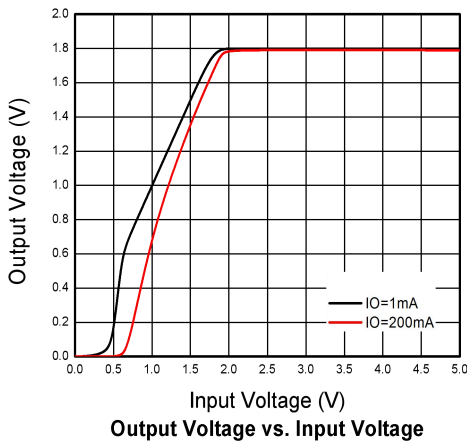

$V_{OUT}=2.8\text{V}$

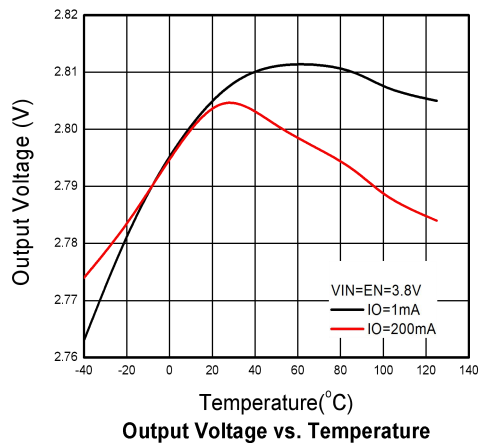
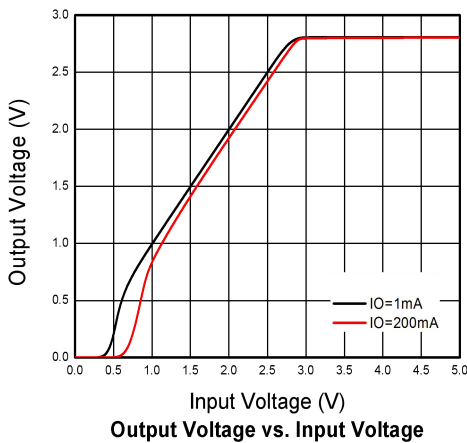

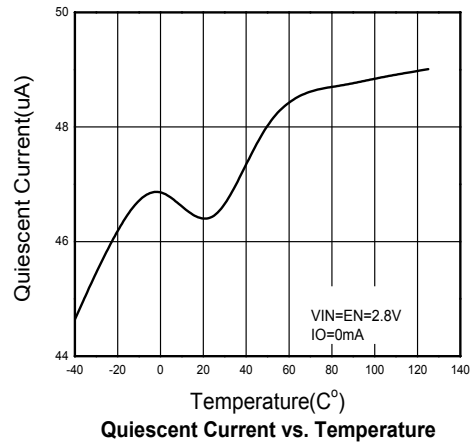
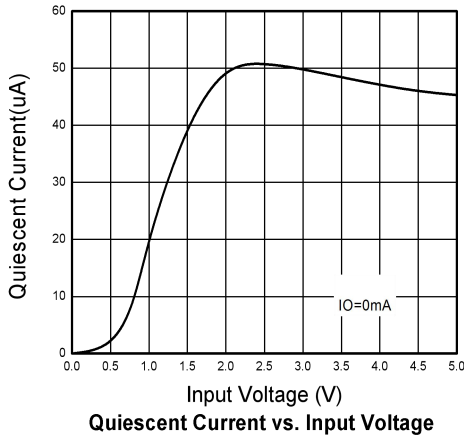
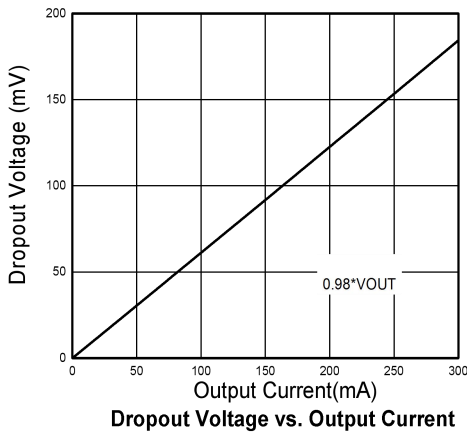
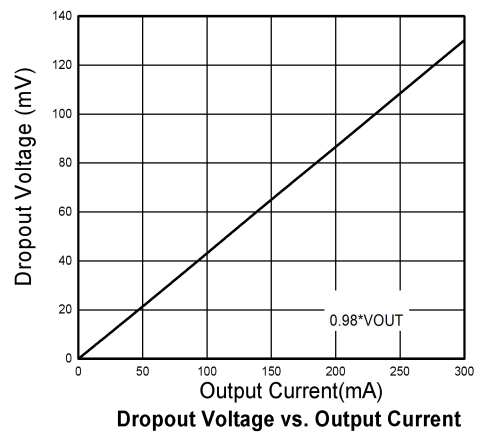
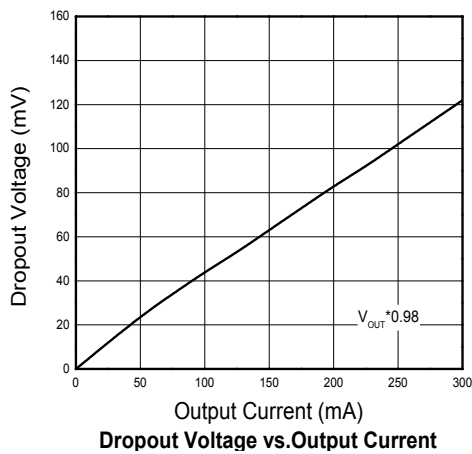
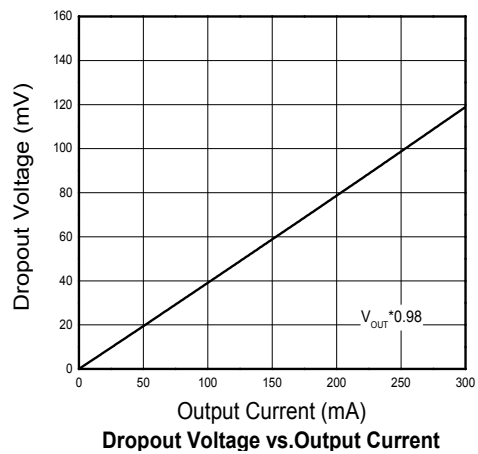
V_{OUT}=1.8V

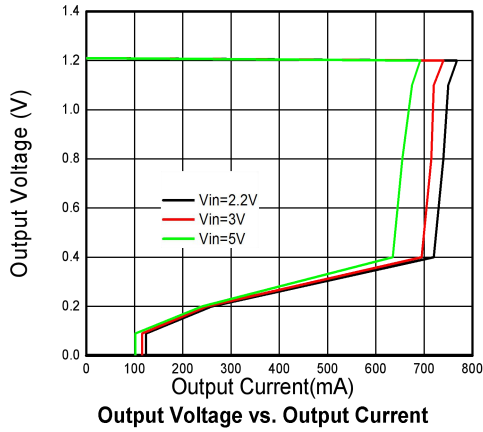
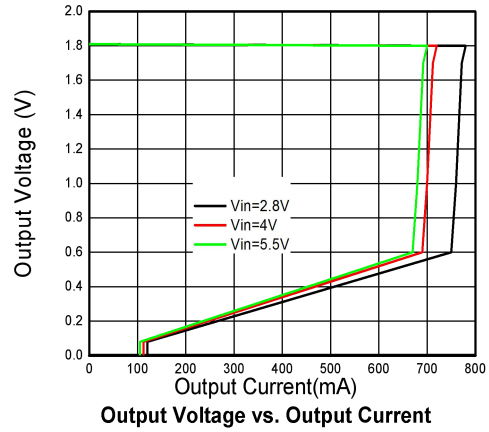
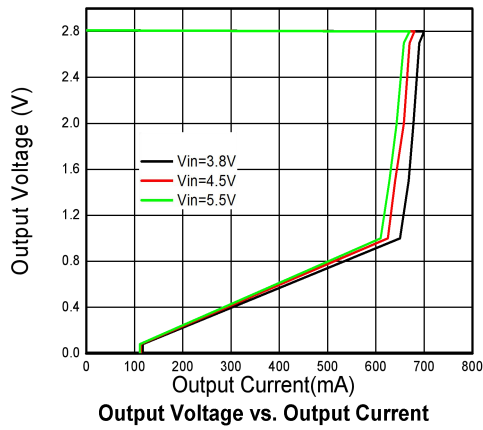
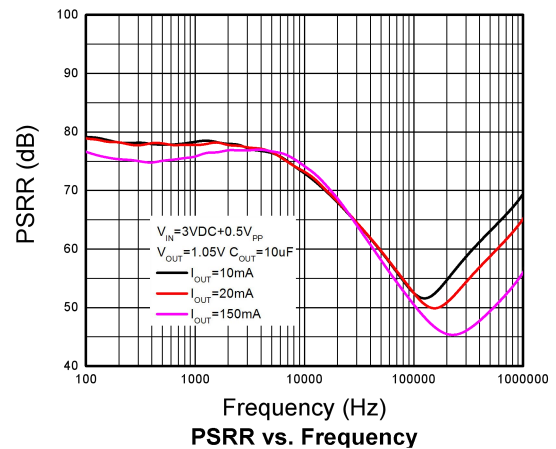
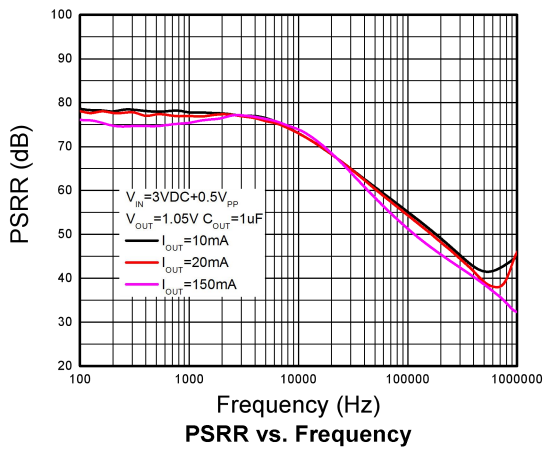
V_{OUT}=1.8V

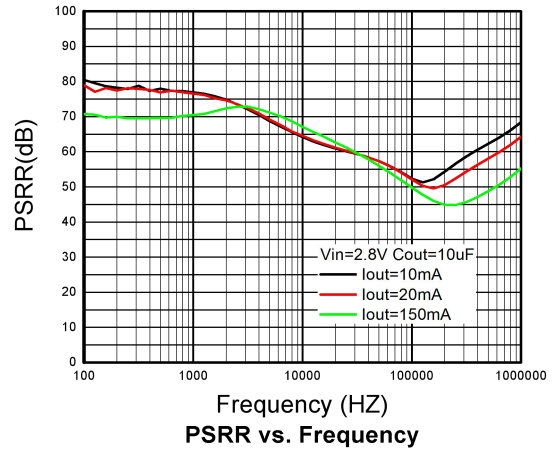
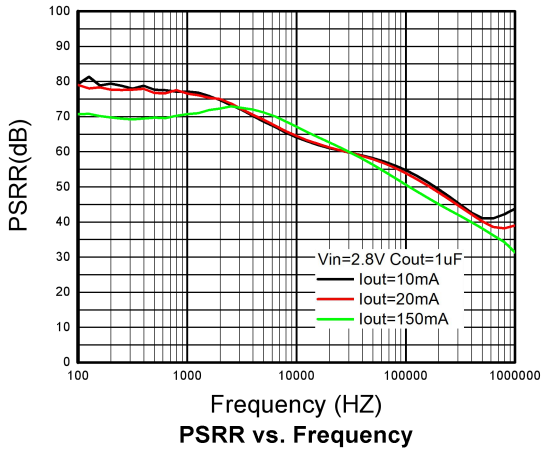
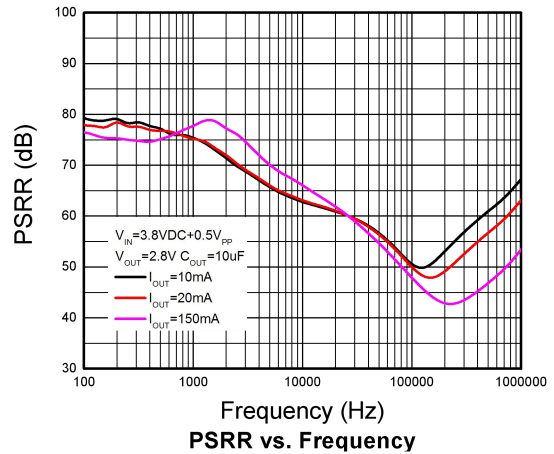
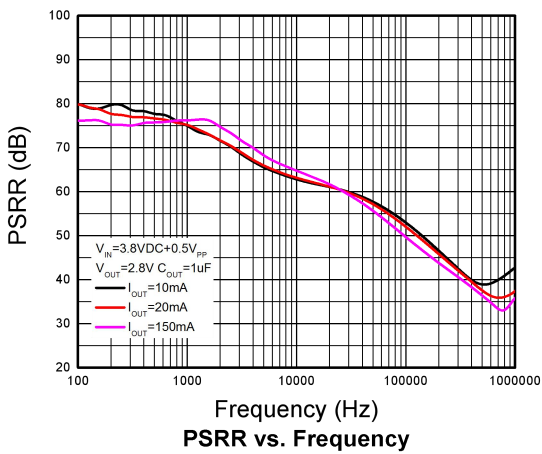
V_{OUT}=2.8V

V_{OUT}=3.0V

V_{OUT}=3.3V

Vout=1.2V

Vout=1.8V

Vout=2.8V

VOUT=1.05V

$V_{OUT}=1.8V$

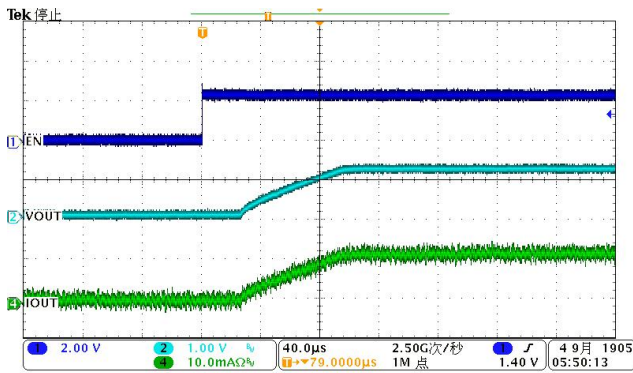
 $V_{OUT}=2.8V$

1.Start up (Soft Start from EN)

$V_{OUT}=1.2V$

$V_{IN}=2.2V, C_{OUT}=1\mu F, I_{OUT}=10mA$



$V_{IN}=2.2V, C_{OUT}=1\mu F, I_{OUT}=250mA$

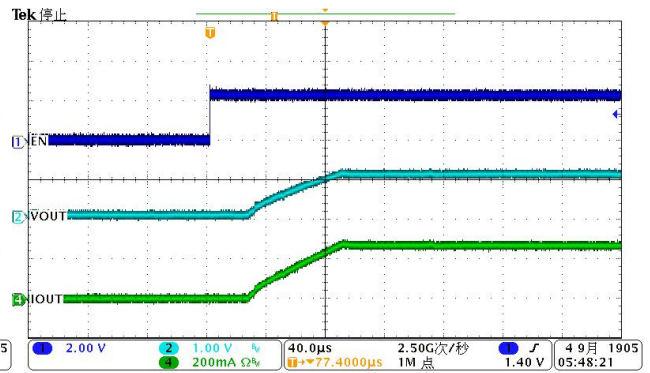

$V_{OUT}=1.8V$

$V_{IN}=2.8V, C_{OUT}=1\mu F, I_{OUT}=10mA$

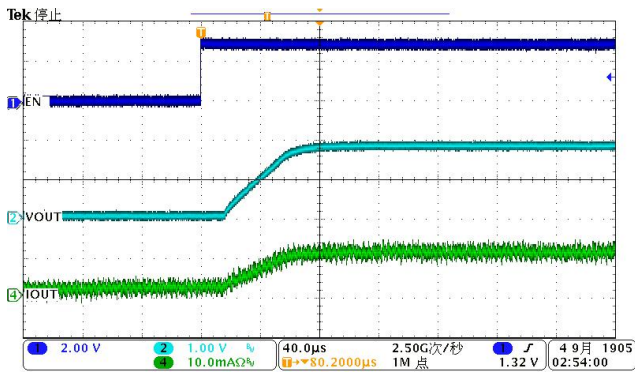

$V_{IN}=2.8V, C_{OUT}=1\mu F, I_{OUT}=300mA$

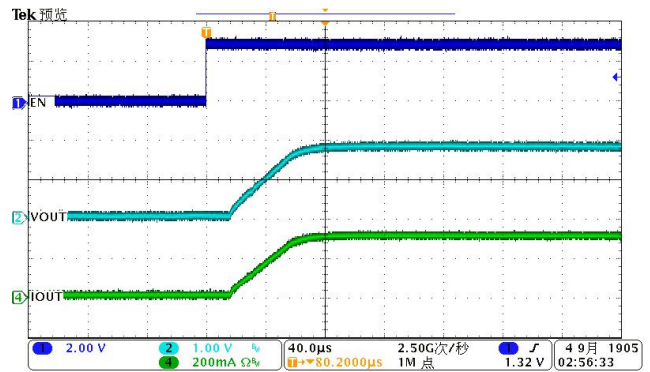

$V_{OUT}=2.8V$

$V_{IN}=3.8V, C_{OUT}=1\mu F, I_{OUT}=10mA$

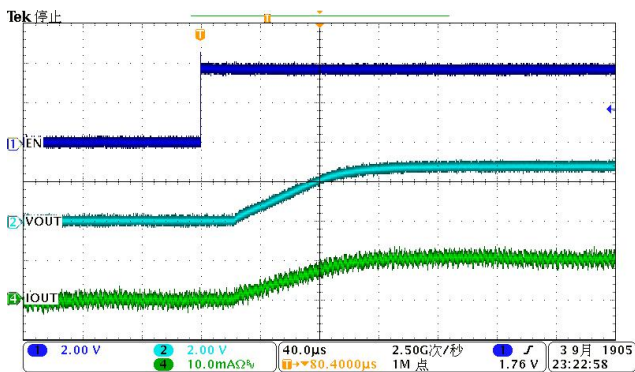

$V_{IN}=3.8V, C_{OUT}=1\mu F, I_{OUT}=300mA$

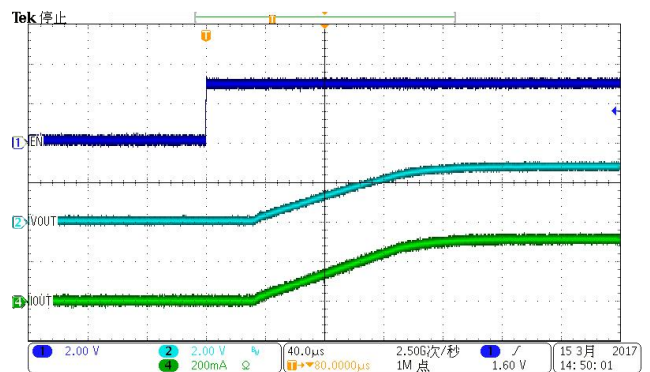

2.Shutdown (Shutdown from EN)

$V_{OUT}=1.2V$

$V_{IN}=2.2V, C_{OUT}=1\mu F, I_{OUT}=10mA$

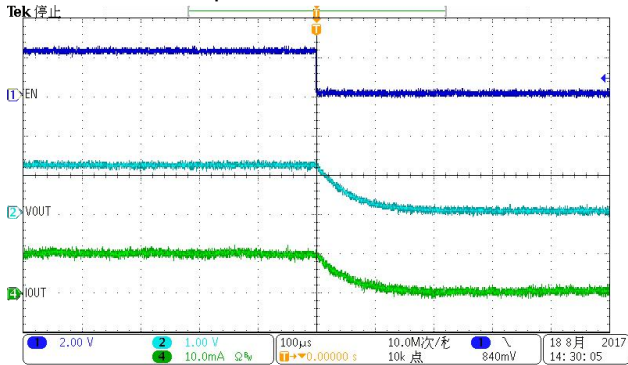

$V_{IN}=2.2V, C_{OUT}=1\mu F, I_{OUT}=300mA$

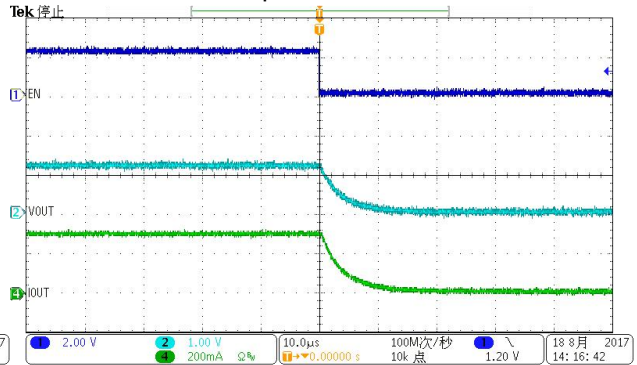

$V_{OUT}=1.8V$

$V_{IN}=2.8V, C_{OUT}=1\mu F, I_{OUT}=10mA$

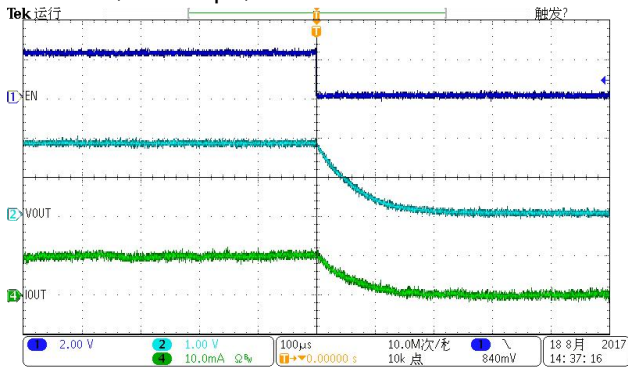

$V_{IN}=2.8V, C_{OUT}=1\mu F, I_{OUT}=300mA$

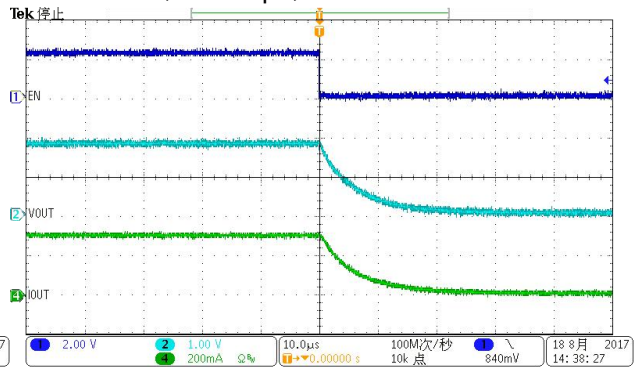

$V_{OUT}=2.8V$

$V_{IN}=3.8V, C_{OUT}=1\mu F, I_{OUT}=10mA$

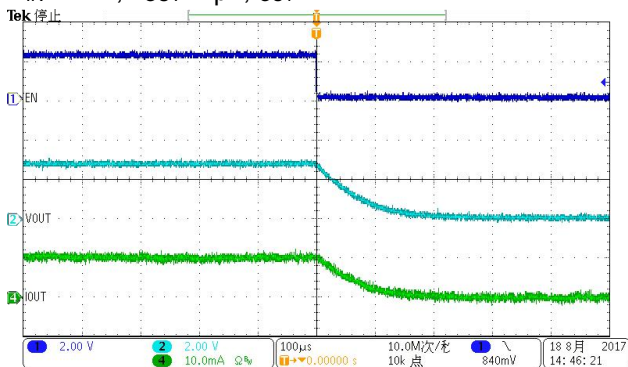

$V_{IN}=3.8V, C_{OUT}=1\mu F, I_{OUT}=300mA$

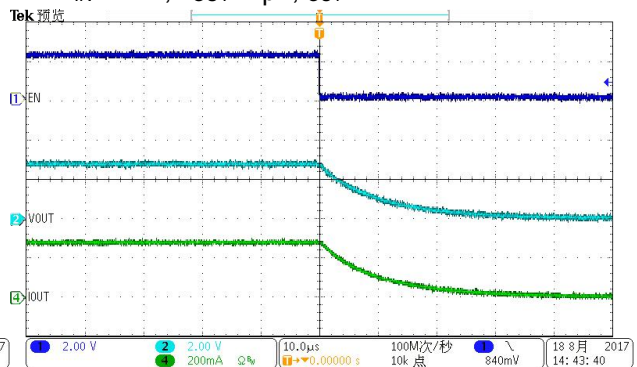

3. Load & Line Transient

Load step

$V_{OUT}=1.2V$

$V_{IN}=2.2V, C_{OUT}=1\mu F, I_{OUT}=1mA-200mA$ in $1\mu s$

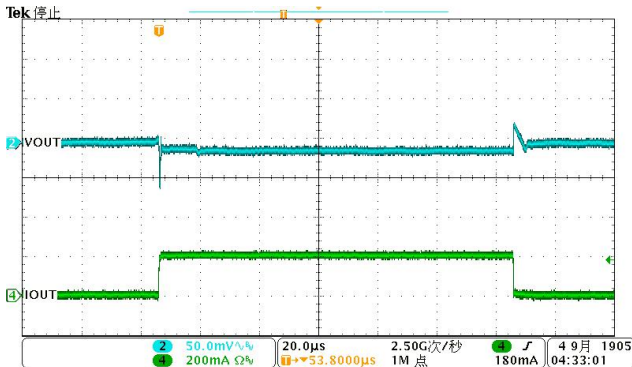

Line Step

$V_{IN}=2.2V-3.2V$ in $20\mu s, C_{OUT}=1\mu F, I_{OUT}=1mA$

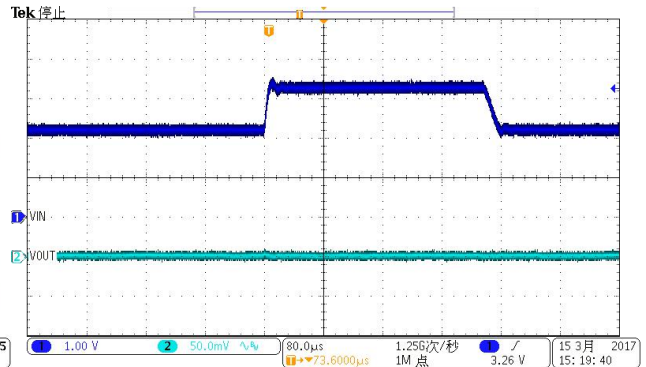

$V_{OUT}=1.8V$

$V_{IN}=2.8V, C_{OUT}=1\mu F, I_{OUT}=1mA-300mA$ in $1\mu s$

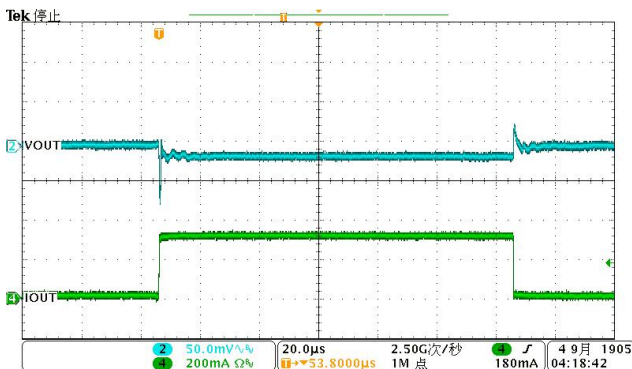

$V_{IN}=2.8V-3.8V$ in $20\mu s, C_{OUT}=1\mu F, I_{OUT}=1mA$

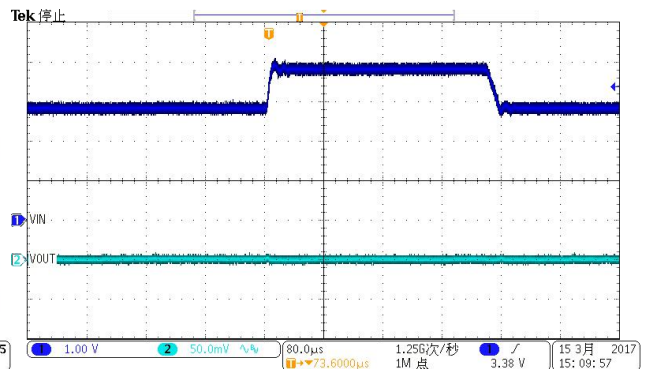

$V_{OUT}=2.8V$

$V_{IN}=3.8V, C_{OUT}=1\mu F, I_{OUT}=1mA-300mA$ in $1\mu s$

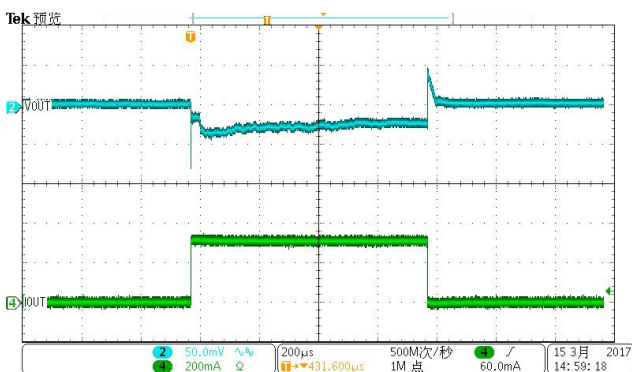

$V_{IN}=3.8V-4.8V$ in $20\mu s, C_{OUT}=1\mu F, I_{OUT}=1mA$

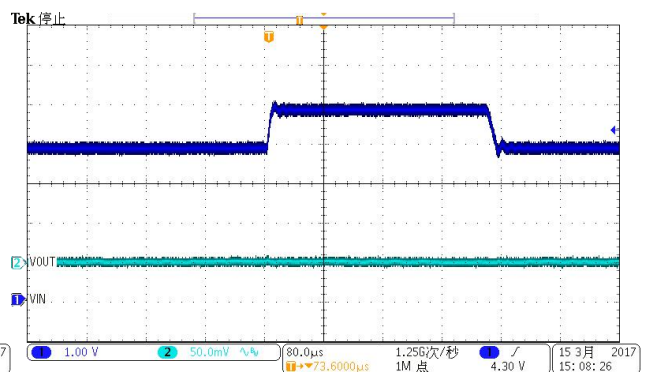

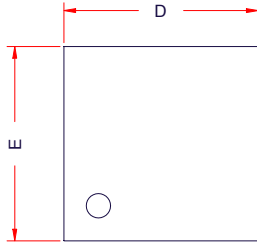
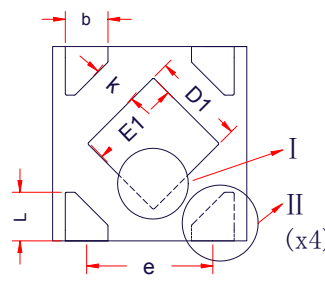
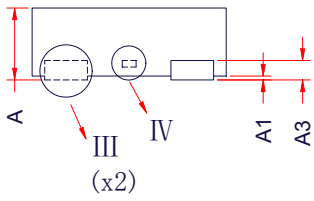
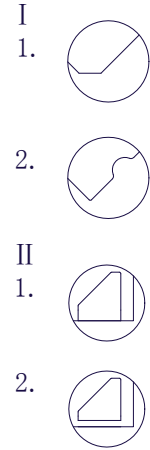
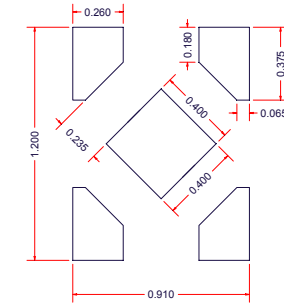
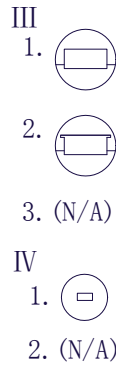
PACKAGE OUTLINE DIMENSIONS
DFN1x1-4L

TOP VIEW

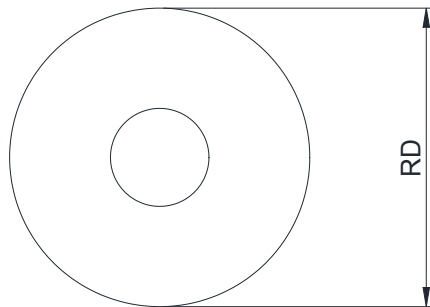
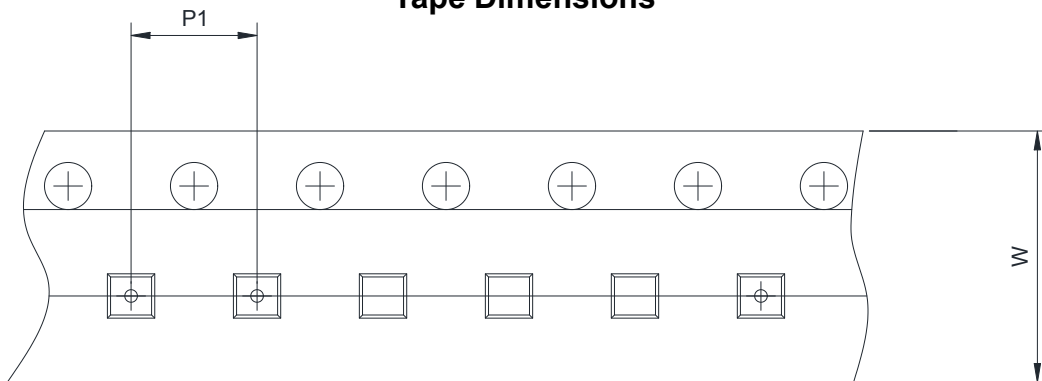
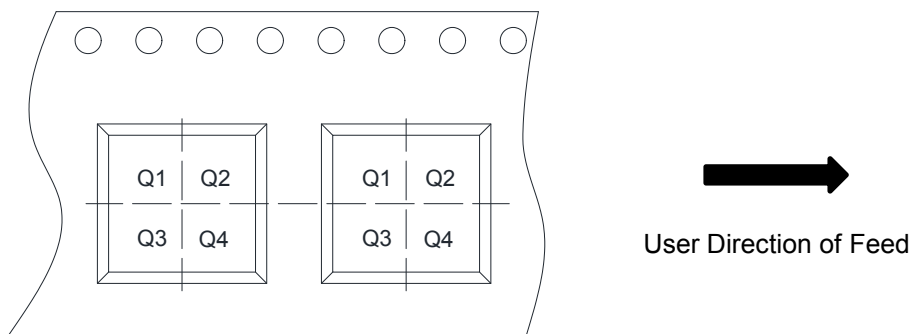
BOTTOM VIEW

SIDE VIEW

RECOMMENDED LAND PATTERN (Unit:mm)

Symbol	Dimensions in Millimeters		
	Min.	Typ.	Max.
A	0.32	0.37	0.42
A1	-	-	0.05
A3	0.10 Ref.		
b	0.17	0.22	0.28
L	0.17	-	0.30
D	0.95	1.00	1.05
E	0.95	1.00	1.05
D1	0.43	0.48	0.54
E1	0.43	0.48	0.54
K	0.14	-	-
e	0.65BSC		

TAPE AND REEL INFORMATION
Reel Dimensions

Tape Dimensions

Quadrant Assignments For PIN1 Orientation In Tape

RD	Reel Dimension	<input checked="" type="checkbox"/> 7inch	<input type="checkbox"/> 13inch
W	Overall width of the carrier tape	<input checked="" type="checkbox"/> 8mm	<input type="checkbox"/> 12mm <input type="checkbox"/> 16mm
P1	Pitch between successive cavity centers	<input checked="" type="checkbox"/> 2mm	<input type="checkbox"/> 4mm <input type="checkbox"/> 8mm
Pin1	Pin1 Quadrant	<input checked="" type="checkbox"/> Q1	<input type="checkbox"/> Q2 <input type="checkbox"/> Q3 <input type="checkbox"/> Q4

ORDER INFORMATION

Ordering No.	Vout (V)	Package	Operating Temperature	Marking	Shipping
WL2836D08-4/TR	0.8	DFN1x1-4L	-40~+85°C	Ih YW	Tape and Reel, 10000
WL2836D09-4/TR	0.9	DFN1x1-4L	-40~+85°C	IA YW	Tape and Reel, 10000
WL2836D10-4/TR	1.0	DFN1x1-4L	-40~+85°C	IB YW	Tape and Reel, 10000
WL2836D105-4/TR	1.05	DFN1x1-4L	-40~+85°C	IC YW	Tape and Reel, 10000
WL2836D11-4/TR	1.1	DFN1x1-4L	-40~+85°C	ID YW	Tape and Reel, 10000
WL2836D12-4/TR	1.2	DFN1x1-4L	-40~+85°C	IE YW	Tape and Reel, 10000
WL2836D15-4/TR	1.5	DFN1x1-4L	-40~+85°C	IG YW	Tape and Reel, 10000
WL2836D18-4/TR	1.8	DFN1x1-4L	-40~+85°C	IH YW	Tape and Reel, 10000
WL2836D25-4/TR	2.5	DFN1x1-4L	-40~+85°C	IK YW	Tape and Reel, 10000
WL2836D27-4/TR	2.7	DFN1x1-4L	-40~+85°C	IY YW	Tape and Reel, 10000
WL2836D28-4/TR	2.8	DFN1x1-4L	-40~+85°C	IL YW	Tape and Reel, 10000
WL2836D29-4/TR	2.9	DFN1x1-4L	-40~+85°C	Ig YW	Tape and Reel, 10000
WL2836D30-4/TR	3.0	DFN1x1-4L	-40~+85°C	IM YW	Tape and Reel, 10000
WL2836D33-4/TR	3.3	DFN1x1-4L	-40~+85°C	IN YW	Tape and Reel, 10000

X-ON Electronics

Largest Supplier of Electrical and Electronic Components

Click to view similar products for [LDO Voltage Regulators](#) category:

Click to view products by [Will Semiconductor](#) manufacturer:

Other Similar products are found below :

[M38D29FFHP#U1](#) [702103A](#) [717726C](#) [742457H](#) [MP20051DN-LF-Z](#) [R5F111PGGFB#30](#) [AP7363-SP-13](#) [NCP103AMX285TCG](#)
[NCV8664CST33T3G](#) [NCV8752AMX28TCG](#) [L9454](#) [AP7362-HA-7](#) [LX13043CLD](#) [TCR3DF185,LM\(CT](#) [TCR3DF24,LM\(CT](#)
[TCR3DF285,LM\(CT](#) [TCR3DF31,LM\(CT](#) [TCR3DF45,LM\(CT](#) [TLF4949EJ](#) [L9708](#) [L970813TR](#) [030014BB](#) [059985X](#) [EAN61387601](#)
[EAN61573601](#) [NCP121AMX173TCG](#) [NCP4687DH15T1G](#) [NCV8703MX30TCG](#) [701326R](#) [702087BB](#) [755078E](#) [TCR2EN28,LF\(S](#)
[LM1117DT-1.8/NO](#) [LT1086CM#TRPBF](#) [AZ1085S2-1.5TRE1](#) [MAX15101EWL+T](#) [NCV8170AXV250T2G](#) [SCD337BTG](#)
[TCR3DF27,LM\(CT](#) [TCR3DF19,LM\(CT](#) [TCR3DF125,LM\(CT](#) [TCR2EN18,LF\(S](#) [MAX15103EWL+T](#) [TS2937CZ-5.0 C0](#) [MAX8878EUK30-](#)
[T](#) [MAX663CPA](#) [NCV4269CPD50R2G](#) [NCV8716MT30TBG](#) [AZ1117IH-1.2TRG1](#) [MP2013GQ-P](#)