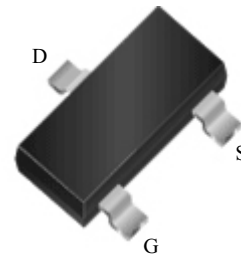
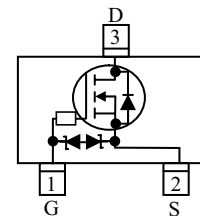
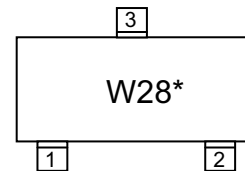

WNM2020
N-Channel, 20V, 0.90A, Small Signal MOSFET
[Http://www.sh-willsemi.com](http://www.sh-willsemi.com)

V_{DS} (V)	$R_{ds(on)}$ (Ω)
20	0.220@ $V_{GS}=4.5V$
	0.260@ $V_{GS}=2.5V$
	0.320@ $V_{GS}=1.8V$

SOT-23
Descriptions

The WNM2020 is N-Channel enhancement MOS Field Effect Transistor. Uses advanced trench technology and design to provide excellent $R_{DS(ON)}$ with low gate charge. This device is suitable for use in DC-DC conversion, power switch and charging circuit. Standard Product WNM2020 is Pb-free and Halogen-free.

Pin configuration (Top view)

W28 = Device Code

* = Month (A~Z)

Marking
Features

- Trench Technology
- Supper high density cell design
- Excellent ON resistance
- Extremely Low Threshold Voltage
- Small package SOT-23

Applications

- DC-DC converter circuit
- Small Signal Switch
- Load Switch
- Level Shift
-

Order information

Device	Package	Shipping
WNM2020-3/TR	SOT-23	3000/Reel&Tape

Absolute Maximum ratings

Parameter		Symbol	10 S	Steady State	Unit
Drain-Source Voltage		V_{DS}	20		V
Gate-Source Voltage		V_{GS}	± 6		
Continuous Drain Current ^a	$T_A=25^\circ\text{C}$	I_D	0.90	0.83	A
	$T_A=70^\circ\text{C}$		0.72	0.66	
Maximum Power Dissipation ^a	$T_A=25^\circ\text{C}$	P_D	0.38	0.32	W
	$T_A=70^\circ\text{C}$		0.24	0.20	
Continuous Drain Current ^b	$T_A=25^\circ\text{C}$	I_D	0.79	0.71	A
	$T_A=70^\circ\text{C}$		0.63	0.57	
Maximum Power Dissipation ^b	$T_A=25^\circ\text{C}$	P_D	0.29	0.24	W
	$T_A=70^\circ\text{C}$		0.19	0.15	
Pulsed Drain Current ^c		I_{DM}	1.4		A
Operating Junction Temperature		T_J	-55 to 150		$^\circ\text{C}$
Lead Temperature		T_L	260		$^\circ\text{C}$
Storage Temperature Range		T_{stg}	-55 to 150		$^\circ\text{C}$

Thermal resistance ratings

Parameter		Symbol	Typical	Maximum	Unit
Junction-to-Ambient Thermal Resistance ^a	$t \leq 10 \text{ s}$	$R_{\theta JA}$	270	325	$^\circ\text{C/W}$
	Steady State		320	385	
Junction-to-Ambient Thermal Resistance ^b	$t \leq 10 \text{ s}$	$R_{\theta JA}$	360	420	
	Steady State		425	520	
Junction-to-Case Thermal Resistance		$R_{\theta JC}$	260	300	

a Surface mounted on FR4 Board using 1 square inch pad size, 1oz copper

b Surface mounted on FR4 board using minimum pad size, 1oz copper

c Repetitive rating, pulse width limited by junction temperature, $t_p=10\mu\text{s}$, Duty Cycle=1%

d Repetitive rating, pulse width limited by junction temperature $T_J=150^\circ\text{C}$.

Electronics Characteristics (Ta=25°C, unless otherwise noted)

Parameter	Symbol	Test Conditions	Min	Typ	Max	Unit
OFF CHARACTERISTICS						
Drain-to-Source Breakdown Voltage	BV_{DSS}	$V_{GS} = 0\text{ V}, I_D = 250\mu\text{A}$	20			V
Zero Gate Voltage Drain Current	I_{DSS}	$V_{DS} = 16\text{ V}, V_{GS} = 0\text{V}$			1	μA
Gate-to-source Leakage Current	I_{GSS}	$V_{DS} = 0\text{ V}, V_{GS} = \pm 5\text{V}$			± 5	μA
ON CHARACTERISTICS						
Gate Threshold Voltage	$V_{GS(TH)}$	$V_{GS} = V_{DS}, I_D = 250\mu\text{A}$	0.45	0.58	0.85	V
Drain-to-source On-resistance	$R_{DS(on)}$	$V_{GS} = 4.5\text{V}, I_D = 0.55\text{A}$		220	310	m Ω
		$V_{GS} = 2.5\text{V}, I_D = 0.45\text{A}$		260	360	
		$V_{GS} = 1.8\text{V}, I_D = 0.35\text{A}$		320	460	
Forward Transconductance	g_{FS}	$V_{DS} = 5\text{ V}, I_D = 0.55\text{A}$		2.0		S
CHARGES, CAPACITANCES AND GATE RESISTANCE						
Input Capacitance	C_{ISS}	$V_{GS} = 0\text{ V}, f = 100\text{ kHz}, V_{DS} = 10\text{ V}$		50		pF
Output Capacitance	C_{OSS}			13		
Reverse Transfer Capacitance	C_{RSS}			8		
Total Gate Charge	$Q_{G(TOT)}$	$V_{GS} = 4.5\text{ V}, V_{DS} = 10\text{ V}, I_D = 0.55\text{A}$		1.15		nC
Threshold Gate Charge	$Q_{G(TH)}$			0.06		
Gate-to-Source Charge	Q_{GS}			0.15		
Gate-to-Drain Charge	Q_{GD}			0.23		
SWITCHING CHARACTERISTICS						
Turn-On Delay Time	$t_d(ON)$	$V_{DD} = 10\text{V}, V_{GS} = 4.5\text{V}, I_D = 0.55\text{A}, R_G = 6\Omega$		22		ns
Rise Time	t_r			80		
Turn-Off Delay Time	$t_d(OFF)$			700		
Fall Time	t_f			380		
BODY DIODE CHARACTERISTICS						
Forward Voltage	V_{SD}	$V_{GS} = 0\text{ V}, I_S = 0.35\text{A}$	0.5	0.7	1.5	V

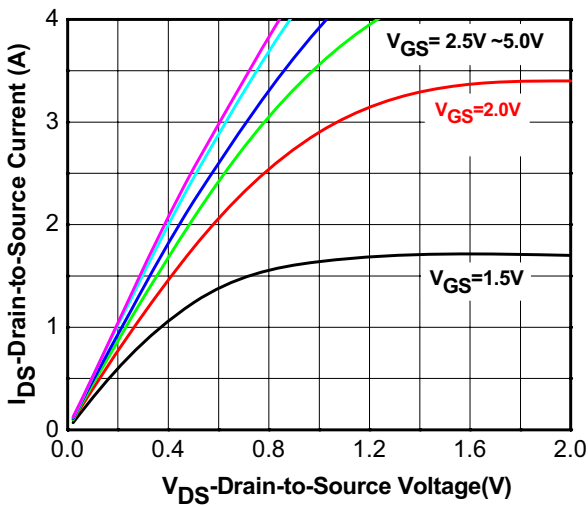
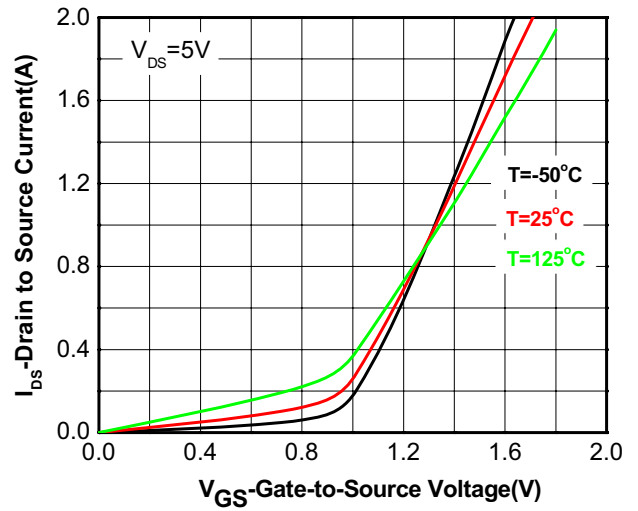
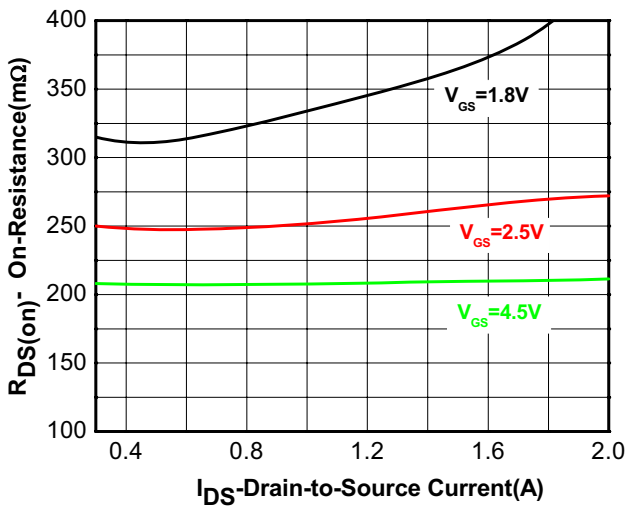
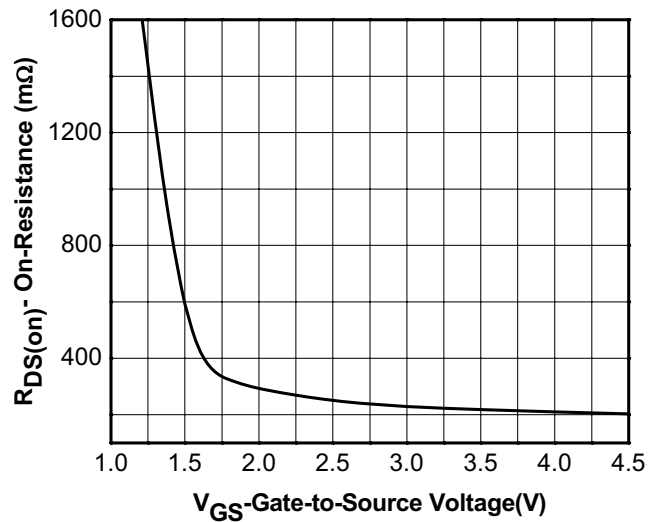
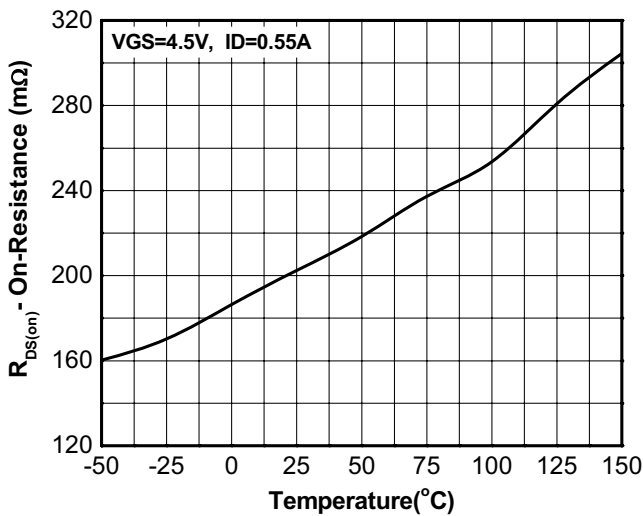
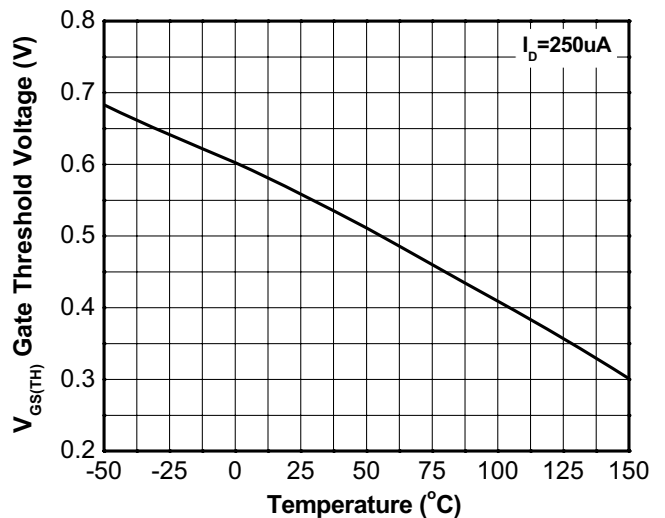
Typical Characteristics (Ta=25°C, unless otherwise noted)

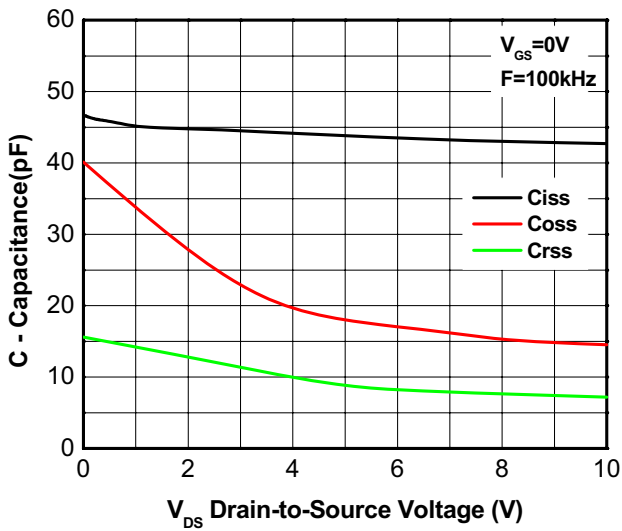
Output characteristics

Transfer characteristics

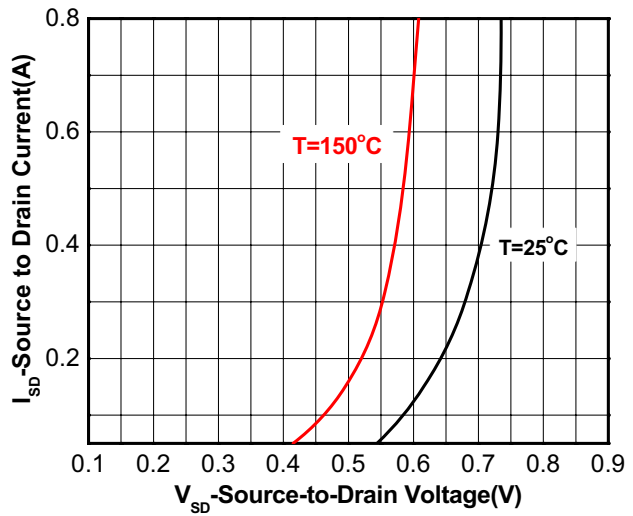
On-Resistance vs. Drain current

On-Resistance vs. Gate-to-Source voltage

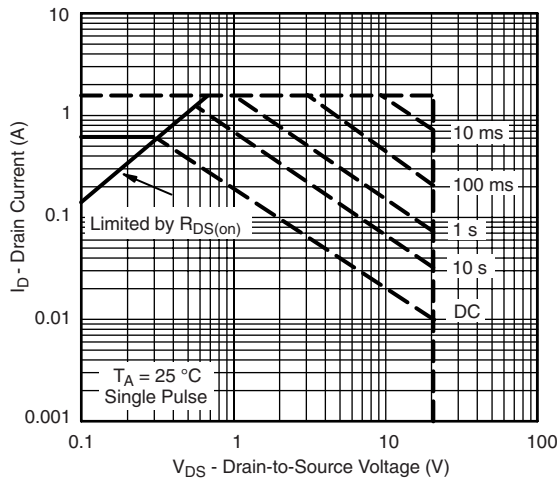
On-Resistance vs. Junction temperature

Threshold voltage vs. Temperature



Capacitance



Body diode forward voltage



Safe operating power

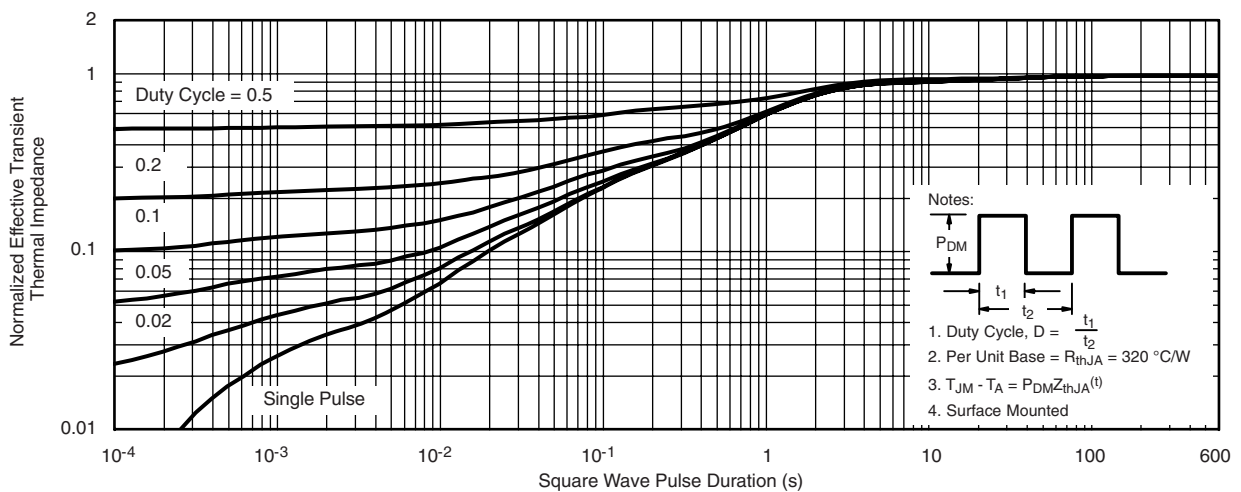

Transient thermal response (Junction-to-Ambient)

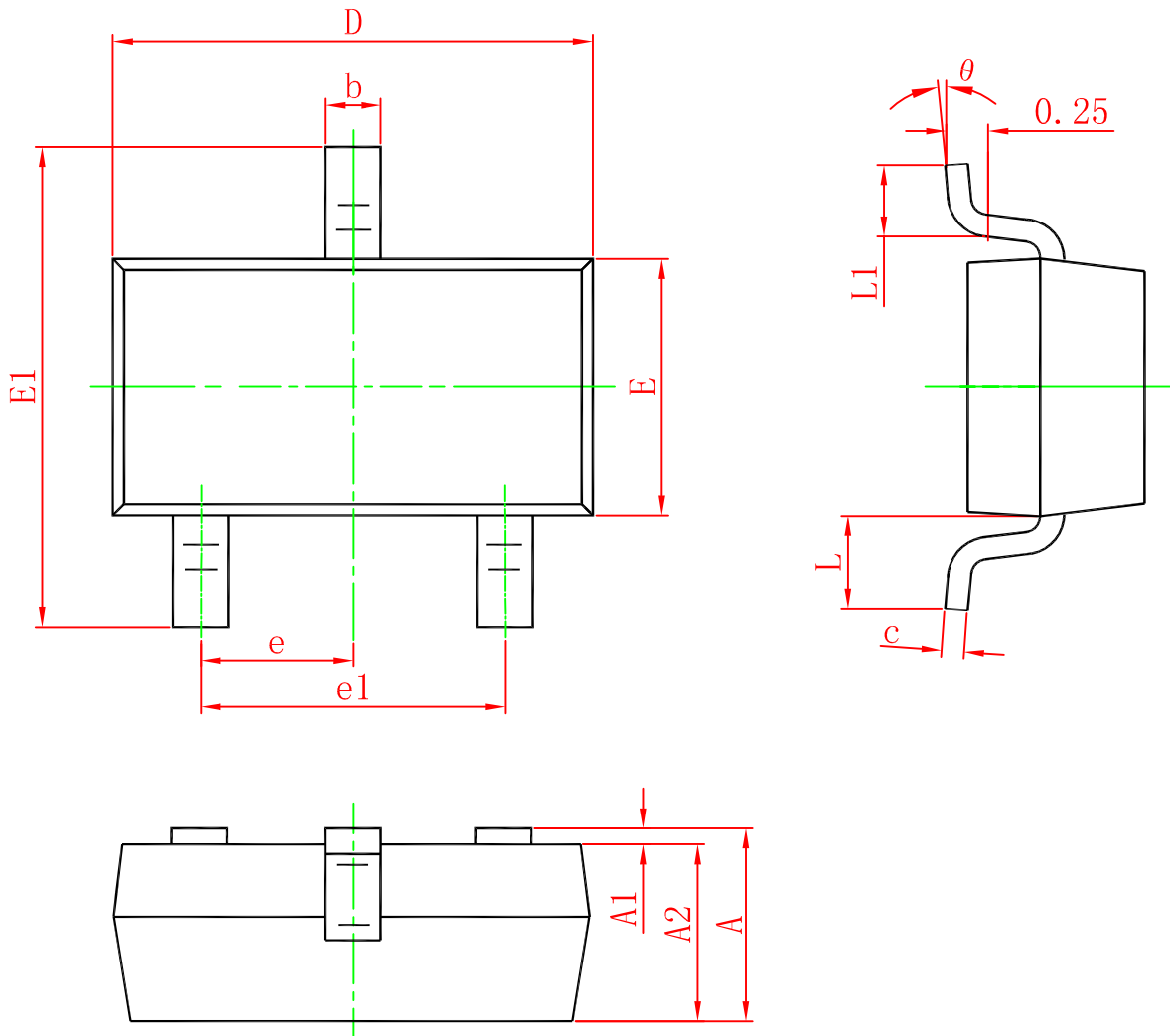
Package outline dimensions
SOT-23

Symbol	Dimensions in millimeter		
	Min.	Typ.	Max.
A	0.900	1.025	1.150
A1	0.000	0.050	0.100
A2	0.900	0.975	1.050
b	0.300	0.400	0.500
c	0.080	0.115	0.150
D	2.800	2.900	3.000
E	1.200	1.300	1.400
E1	2.250	2.400	2.550
e	0.950TYP		
e1	1.800	1.900	2.000
L	0.550REF		
L1	0.300		0.500
θ	0°		8°

X-ON Electronics

Largest Supplier of Electrical and Electronic Components

Click to view similar products for [MOSFET](#) category:

Click to view products by [Will Semiconductor](#) manufacturer:

Other Similar products are found below :

[614233C](#) [648584F](#) [MCH3443-TL-E](#) [MCH6422-TL-E](#) [FDPF9N50NZ](#) [IRFD120](#) [IRFF430](#) [JANTX2N5237](#) [2N7000](#) [FCA20N60_F109](#)
[FDZ595PZ](#) [2SK2267\(Q\)](#) [2SK2545\(Q,T\)](#) [405094E](#) [423220D](#) [MIC4420CM-TR](#) [VN1206L](#) [614234A](#) [715780A](#) [SSM6J414TU,LF\(T](#) [751625C](#)
[PSMN4R2-30MLD](#) [TK31J60W5,S1VQ\(O](#) [2SK2614\(TE16L1,Q\)](#) [DMN1017UCP3-7](#) [EFC2J004NUZTDG](#) [FCAB21350L1](#) [P85W28HP2F-](#)
[7071](#) [DMN1053UCP4-7](#) [NTE2384](#) [NTE2969](#) [NTE6400A](#) [DMN61D9UWQ-13](#) [US6M2GTR](#) [DMN31D5UDJ-7](#) [SSM6P54TU,LF](#)
[DMP22D4UFO-7B](#) [IPS60R3K4CEAKMA1](#) [DMN1006UCA6-7](#) [DMN16M9UCA6-7](#) [STF5N65M6](#) [STU5N65M6](#) [C3M0021120D](#)
[DMN13M9UCA6-7](#) [BSS340NWH6327XTSA1](#) [MCM3400A-TP](#) [DMTH10H4M6SPS-13](#) [IPS60R1K0PFD7SAKMA1](#)
[IPS60R360PFD7SAKMA1](#) [IPS60R600PFD7SAKMA1](#)