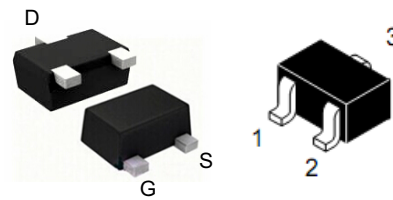
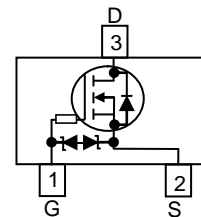
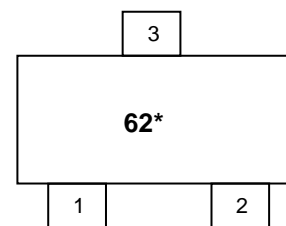

**WNM6002**
**Single N-Channel, 60V, 0.30A, Power MOSFET**
[Http://www.sh-willsemi.com](http://www.sh-willsemi.com)

$V_{DS}$ (V)	$R_{ds(on)}$ ( $\Omega$ )
60	1.4@ $V_{GS}=10V$
	1.7@ $V_{GS}=4.5V$
ESD Rating:2000V HBM	

**SOT-323**
**Descriptions**

The WNM6002 is N-Channel enhancement MOS Field Effect Transistor. Uses advanced trench technology and design to provide excellent  $R_{DS(ON)}$  with low gate charge. This device is suitable for use in DC-DC conversion, power switch and charging circuit. Standard Product WNM6002 is Pb-free and Halogen-free.

**Pin configuration (Top view)**

62 = Device Code  
 \* = Month (A~Z)

**Marking**
**Features**

- Trench Technology
- Supper high density cell design
- Excellent ON resistance for higher DC current
- Extremely Low Threshold Voltage
- Small package SOT-323

**Applications**

- Driver for Relay, Solenoid, Motor, LED etc.
- DC-DC converter circuit
- Power Switch
- Load Switch
- Charging

**Order information**

Device	Package	Shipping
WNM6002-3/TR	SOT-323	3000/Reel&Tape

Parameter		Symbol	10 s	Steady State	Unit
Drain-Source Voltage		$V_{DS}$	60		V
Gate-Source Voltage		$V_{GS}$	$\pm 20$		
Continuous Drain Current <sup>ad</sup>	$T_A=25^\circ\text{C}$	$I_D$	0.30	0.28	A
	$T_A=70^\circ\text{C}$		0.24	0.22	
Maximum Power Dissipation <sup>ad</sup>	$T_A=25^\circ\text{C}$	$P_D$	0.37	0.31	W
	$T_A=70^\circ\text{C}$		0.23	0.20	
Continuous Drain Current <sup>bd</sup>	$T_A=25^\circ\text{C}$	$I_D$	0.27	0.24	A
	$T_A=70^\circ\text{C}$		0.21	0.19	
Maximum Power Dissipation <sup>bd</sup>	$T_A=25^\circ\text{C}$	$P_D$	0.29	0.23	W
	$T_A=70^\circ\text{C}$		0.18	0.14	
Pulsed Drain Current <sup>c</sup>		$I_{DM}$	1.0		A
Operating Junction Temperature		$T_J$	-55 to 150		$^\circ\text{C}$
Lead Temperature		$T_L$	260		$^\circ\text{C}$
Storage Temperature Range		$T_{stg}$	-55 to 150		$^\circ\text{C}$

### Thermal resistance ratings

Parameter		Symbol	Typical	Maximum	Unit
Junction-to-Ambient Thermal Resistance <sup>a</sup>	$t \leq 10$ s	$R_{\theta JA}$	245	335	$^\circ\text{C/W}$
	Steady State		325	395	
Junction-to-Ambient Thermal Resistance <sup>b</sup>	$t \leq 10$ s	$R_{\theta JA}$	375	430	
	Steady State		445	535	
Junction-to-Case Thermal Resistance		$R_{\theta JC}$	260	300	

a Surface mounted on FR-4 Board using 1 square inch pad size, 1oz copper

b Surface mounted on FR-4 board using minimum pad size, 1oz copper

c Pulse width < 380 $\mu\text{s}$

d Maximum junction temperature  $T_J=150^\circ\text{C}$ .

**Electronics Characteristics (Ta=25°C, unless otherwise noted)**

Parameter	Symbol	Test Conditions	Min	Typ	Max	Unit
<b>OFF CHARACTERISTICS</b>						
Drain-to-Source Breakdown Voltage	$BV_{DSS}$	$V_{GS} = 0\text{ V}, I_D = 250\mu\text{A}$	60			V
Zero Gate Voltage Drain Current	$I_{DSS}$	$V_{DS} = 60\text{ V}, V_{GS} = 0\text{ V}$			1	$\mu\text{A}$
Gate-to-source Leakage Current	$I_{GSS}$	$V_{DS} = 0\text{ V}, V_{GS} = \pm 20\text{ V}$			$\pm 5$	$\mu\text{A}$
<b>ON CHARACTERISTICS</b>						
Gate Threshold Voltage	$V_{GS(TH)}$	$V_{GS} = V_{DS}, I_D = 250\mu\text{A}$	0.8	1.3	2	V
Drain-to-source On-resistance <sup>b, c</sup>	$R_{DS(on)}$	$V_{GS} = 10\text{ V}, I_D = 0.37\text{ A}$		1.4	2.0	$\Omega$
		$V_{GS} = 4.5\text{ V}, I_D = 0.2\text{ A}$		1.7	2.6	
Forward Transconductance	$g_{FS}$	$V_{DS} = 15\text{ V}, I_D = 0.25\text{ A}$		0.42		S
<b>CAPACITANCES, CHARGES</b>						
Input Capacitance	$C_{ISS}$	$V_{GS} = 0\text{ V},$ $f = 1.0\text{ MHz},$ $V_{DS} = 25\text{ V}$		23.37		pF
Output Capacitance	$C_{OSS}$			7.33		
Reverse Transfer Capacitance	$C_{RSS}$			5.2		
Total Gate Charge	$Q_{G(TOT)}$	$V_{GS} = 10\text{ V},$ $V_{DD} = 30\text{ V},$ $I_D = 0.37\text{ A}$		1.2		nC
Threshold Gate Charge	$Q_{G(TH)}$			0.15		
Gate-to-Source Charge	$Q_{GS}$			0.21		
Gate-to-Drain Charge	$Q_{GD}$			0.12		
<b>SWITCHING CHARACTERISTICS</b>						
Turn-On Delay Time	$t_d(ON)$	$V_{DD} = 30\text{ V}, I_D = 0.2\text{ A},$ $V_{GEN} = 10\text{ V}, R_G = 10\ \Omega$		7.6		ns
Rise Time	$t_r$			5.1		
Turn-Off Delay Time	$t_d(OFF)$			24.6		
Fall Time	$t_f$			10		
<b>BODY DIODE CHARACTERISTICS</b>						
Forward Voltage	$V_{SD}$	$V_{GS} = 0\text{ V}, I_S = 0.3\text{ A}$		0.9	1.5	V

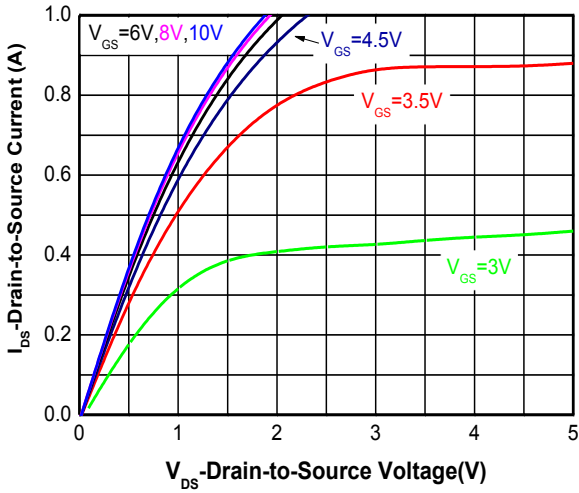
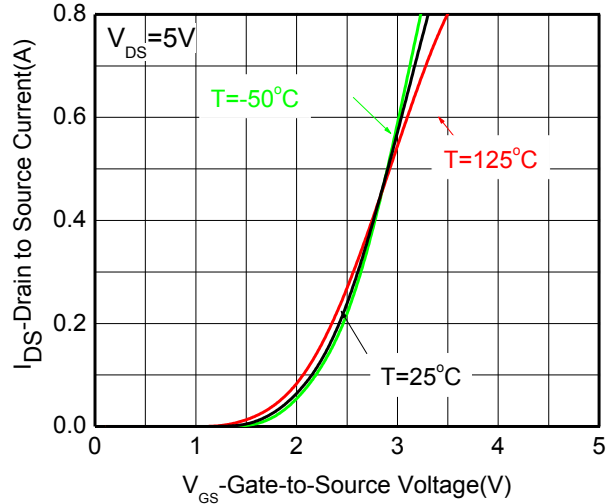
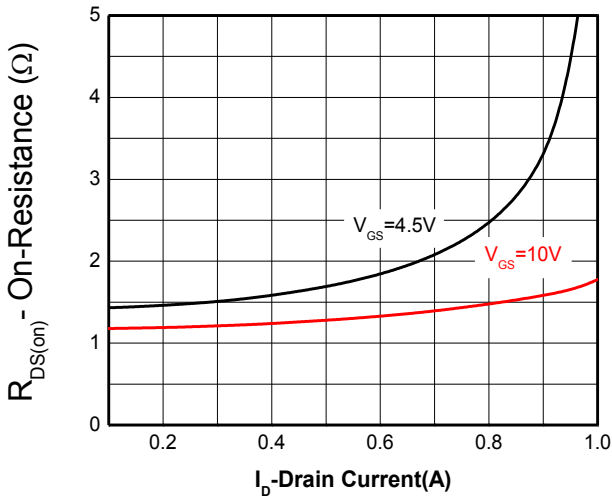
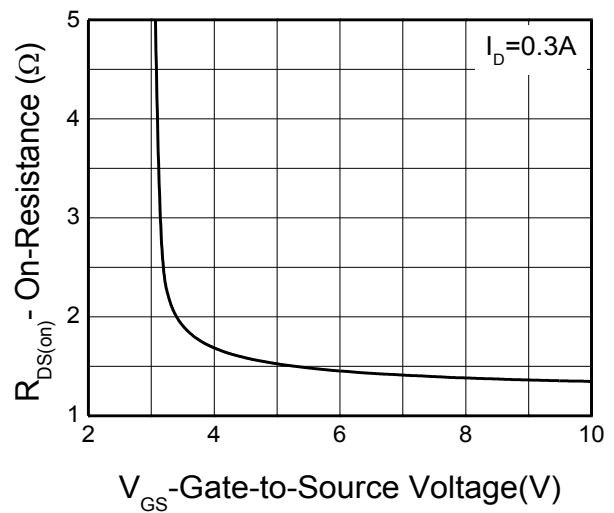
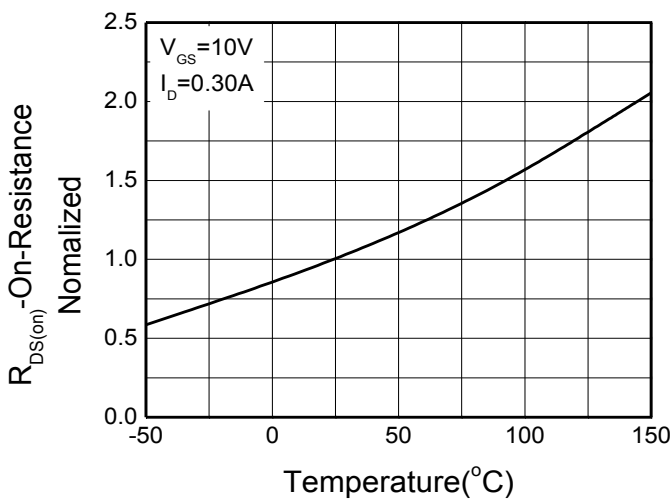
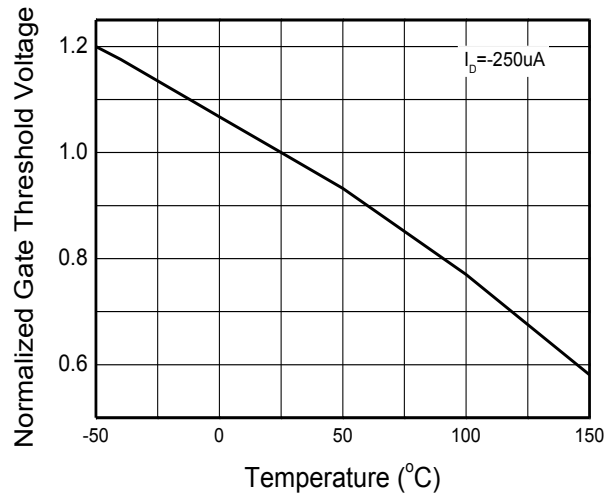
**Typical Characteristics (Ta=25°C, unless otherwise noted)**

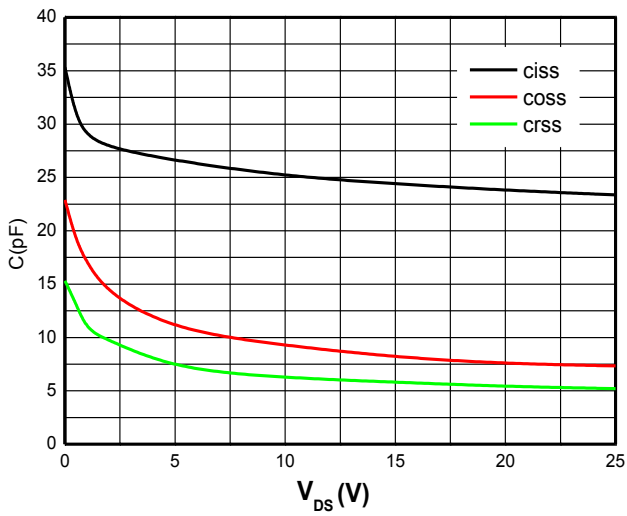
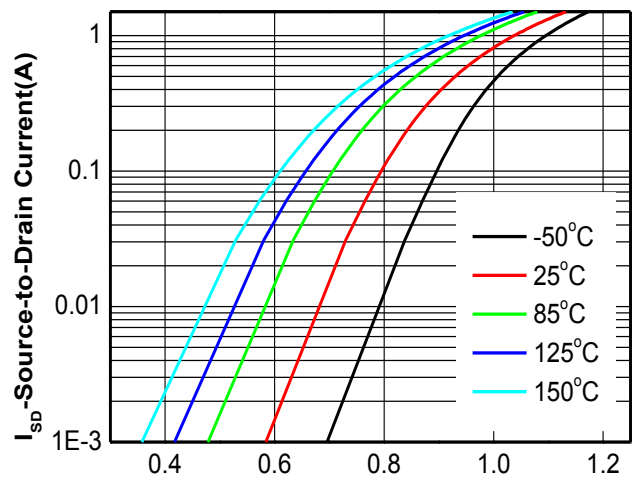
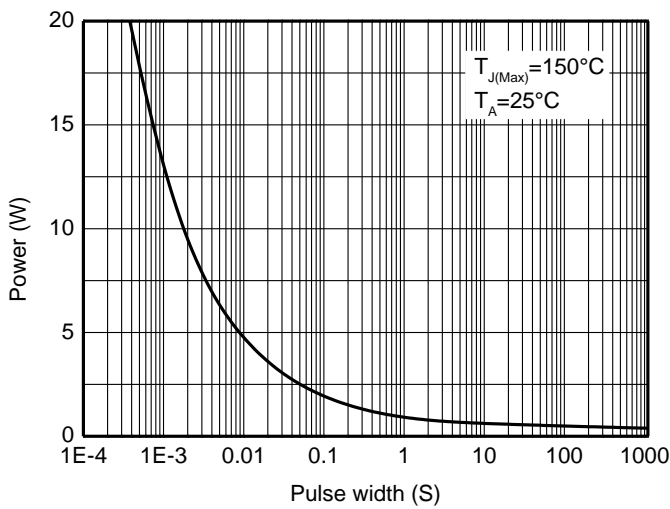
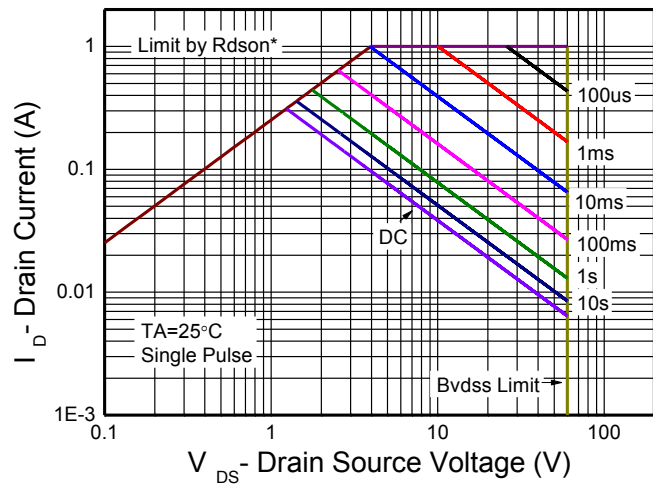
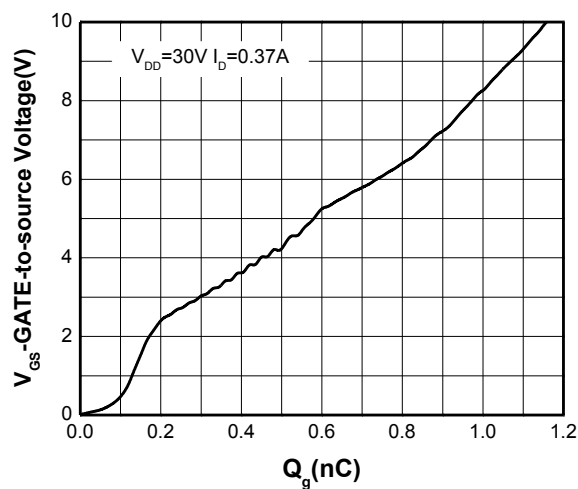
**Output characteristics**

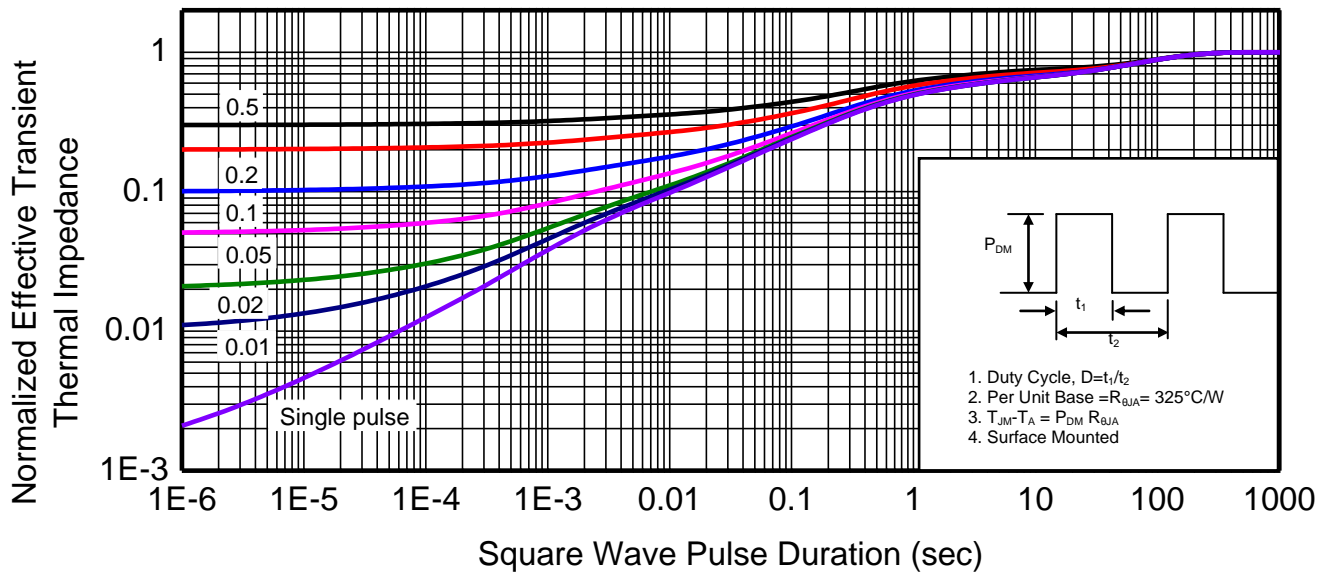
**Transfer characteristics**

**On-Resistance vs. Drain current**

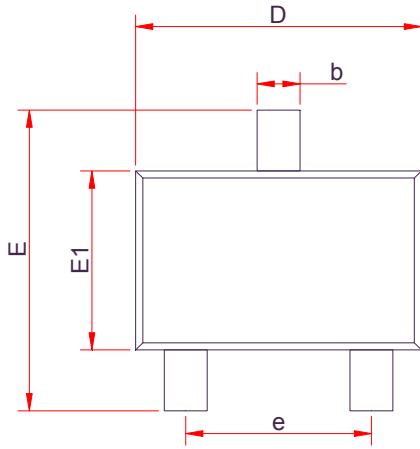
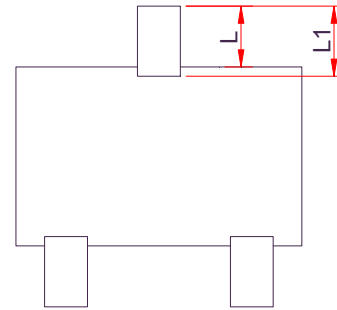
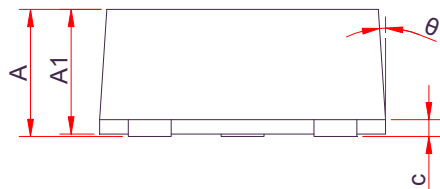
**On-Resistance vs. Gate-to-Source voltage**

**On-Resistance vs. Junction temperature**

**Threshold voltage vs. Temperature**



**Capacitance**

**Body diode forward voltage**

**Single pulse power**

**Safe operating power**

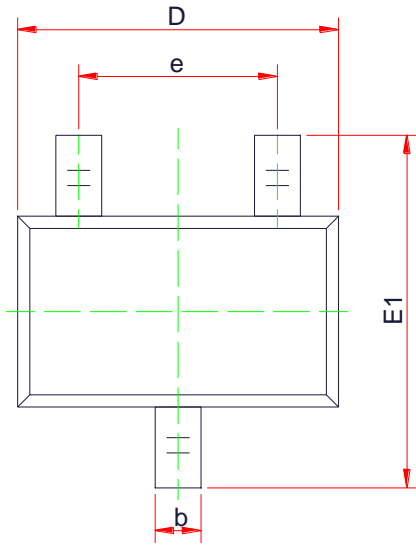
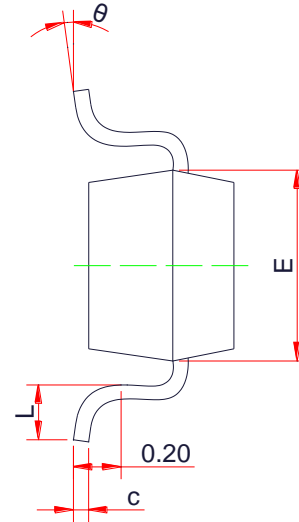
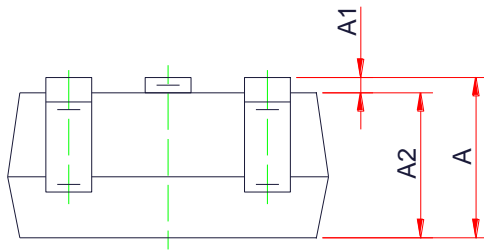
**Gate Charge Characteristics**



**Transient thermal response (Junction-to-Ambient)**

**Package outline dimensions**
**SOT-323**

**TOP VIEW**

**BOTTOM VIEW**

**SIDE VIEW**

Symbol	Dimensions in Millimeters		
	Min.	Typ.	Max.
A	0.80	0.90	1.00
A1	0.89 Ref		
b	0.28	0.30	0.35
e	1.20	1.30	1.40
c	0.11	0.13	0.18
D	1.80	2.00	2.20
E	2.00	2.10	2.20
E1	1.15	1.25	1.35
L1	0.49 Ref		
L	0.42		0.43
$\theta$	5° Ref		

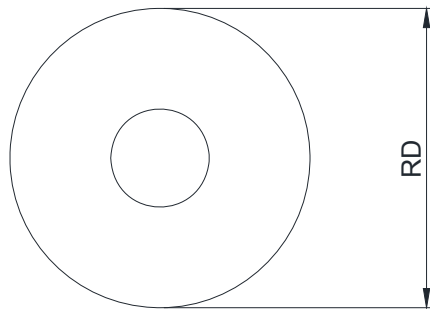
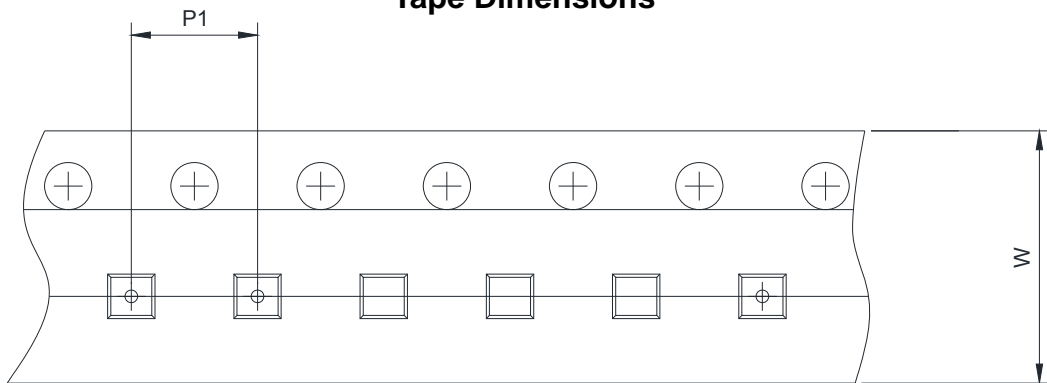
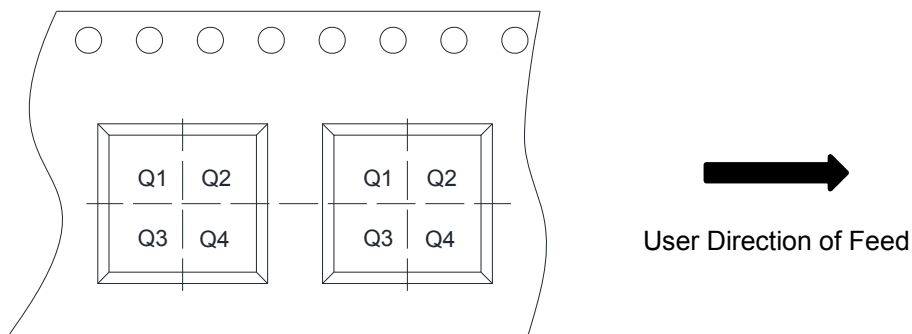
**Package outline dimensions**
**SOT-323**

**TOP VIEW**

**SIDE VIEW**

**SIDE VIEW**

Symbol	Dimensions in Millimeters		
	Min.	Typ.	Max.
A	0.80	0.95	1.10
A1	0.00	-	0.10
A2	0.80	0.90	1.00
b	0.20	0.30	0.40
c	0.05	0.10	0.15
D	1.90	2.05	2.20
E	1.15	1.25	1.25
E1	2.00	2.20	2.45
e	1.20	1.30	1.40
L	0.20	-	-
$\theta$	6° Ref		

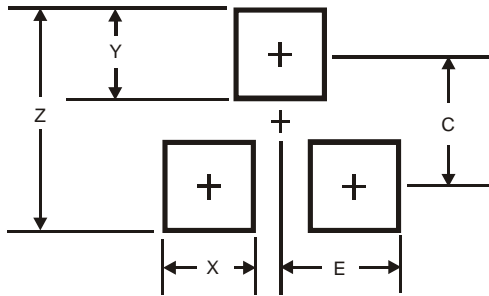

**TAPE AND REEL INFORMATION**
**Reel Dimensions**

**Tape Dimensions**

**Quadrant Assignments For PIN1 Orientation In Tape**

RD	Reel Dimension	<input checked="" type="checkbox"/> 7inch	<input type="checkbox"/> 13inch
W	Overall width of the carrier tape	<input checked="" type="checkbox"/> 8mm	<input type="checkbox"/> 12mm <input type="checkbox"/> 16mm
P1	Pitch between successive cavity centers	<input type="checkbox"/> 2mm	<input checked="" type="checkbox"/> 4mm <input type="checkbox"/> 8mm
Pin1	Pin1 Quadrant	<input type="checkbox"/> Q1	<input type="checkbox"/> Q2 <input checked="" type="checkbox"/> Q3 <input type="checkbox"/> Q4

**Recommend PCB Layout**
**Recommend PCB Layout (Unit: mm)**

Dimensions	SOT323
Z	2.8
X	0.7
Y	0.9
C	1.9
E	1.0

**Notes:**

This recommended land pattern is for reference purposes only. Please consult your manufacturing group to ensure your PCB design guidelines are met.

## X-ON Electronics

Largest Supplier of Electrical and Electronic Components

*Click to view similar products for [MOSFET](#) category:*

*Click to view products by [Will Semiconductor](#) manufacturer:*

Other Similar products are found below :

[614233C](#) [648584F](#) [MCH3443-TL-E](#) [MCH6422-TL-E](#) [FDPF9N50NZ](#) [FW216A-TL-2W](#) [FW231A-TL-E](#) [APT5010JVR](#) [NTNS3A92PZT5G](#)  
[IRF100S201](#) [JANTX2N5237](#) [2SK2464-TL-E](#) [2SK3818-DL-E](#) [FCA20N60\\_F109](#) [FDZ595PZ](#) [STD6600NT4G](#) [FSS804-TL-E](#) [2SJ277-DL-E](#)  
[2SK1691-DL-E](#) [2SK2545\(Q,T\)](#) [D2294UK](#) [405094E](#) [423220D](#) [MCH6646-TL-E](#) [TPCC8103,L1Q\(CM](#) [367-8430-0972-503](#) [VN1206L](#)  
[424134F](#) [026935X](#) [051075F](#) [SBVS138LT1G](#) [614234A](#) [715780A](#) [NTNS3166NZT5G](#) [751625C](#) [873612G](#) [IRF7380TRHR](#)  
[IPS70R2K0CEAKMA1](#) [RJK60S3DPP-E0#T2](#) [RJK60S5DPK-M0#T0](#) [APT5010JVFR](#) [APT12031JFLL](#) [APT12040JVR](#) [DMN3404LQ-7](#)  
[NTE6400](#) [JANTX2N6796U](#) [JANTX2N6784U](#) [JANTXV2N5416U4](#) [SQM110N05-06L-GE3](#) [SIHF35N60E-GE3](#)