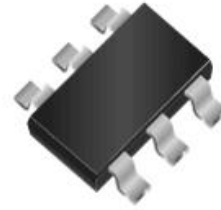
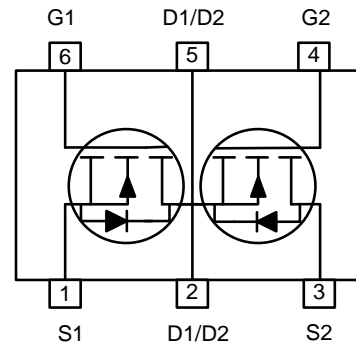

WNMD2167
Dual N-Channel, 20V, 6.3A, Power MOSFET
[Http://www.willsemi.com](http://www.willsemi.com)

V_{DS} (V)	Typical $R_{ds(on)}$ (Ω)
20	0.016 @ $V_{GS}=4.5V$
	0.0175 @ $V_{GS}=3.8V$
	0.018 @ $V_{GS}=3.1V$
	0.020 @ $V_{GS}=2.5V$

SOT-23-6L
Descriptions

The WNMD2167 is N-Channel enhancement MOS Field Effect Transistor. Uses advanced trench technology and design to provide excellent $R_{DS(ON)}$ with low gate charge. This device is suitable for use in DC-DC conversion, power switch and charging circuit. Standard Product WNMD2167 is Pb-free.

Features

- Trench Technology
- Supper high density cell design
- Excellent ON resistance for higher DC current
- Extremely Low Threshold Voltage
- Small package SOT-23-6L

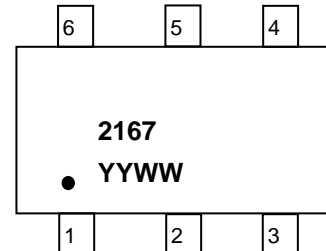
Pin configuration (Top view)

2167 = Device Code
 YY = Year
 WW = Week

Applications

- Driver for Relay, Solenoid, Motor, LED etc.
- DC-DC converter circuit
- Power Switch
- Load Switch
- Charging

Marking
Order information

Device	Package	Shipping
WNMD2167-6/TR	SOT-23-6L	3000/Reel&Tape

Absolute Maximum ratings

Parameter	Symbol	10 S	Steady State	Unit	
Drain-Source Voltage	V_{DS}	20		V	
Gate-Source Voltage	V_{GS}	± 10			
Continuous Drain Current ^{a d}	I_D	$T_A=25^{\circ}\text{C}$	6.3	5.7	A
		$T_A=70^{\circ}\text{C}$	5.0	4.6	
Maximum Power Dissipation ^{a d}	P_D	$T_A=25^{\circ}\text{C}$	1.1	0.9	W
		$T_A=70^{\circ}\text{C}$	0.7	0.6	
Continuous Drain Current ^b	I_D	$T_A=25^{\circ}\text{C}$	5.8	5.2	A
		$T_A=70^{\circ}\text{C}$	4.6	4.1	
Maximum Power Dissipation ^b	P_D	$T_A=25^{\circ}\text{C}$	0.9	0.7	W
		$T_A=70^{\circ}\text{C}$	0.6	0.5	
Pulsed Drain Current ^c	I_{DM}	30		A	
Operating Junction Temperature	T_J	-55 to 150		$^{\circ}\text{C}$	
Lead Temperature	T_L	260		$^{\circ}\text{C}$	
Storage Temperature Range	T_{stg}	-55 to 150		$^{\circ}\text{C}$	

Thermal resistance ratings

Single Operation					
Parameter		Symbol	Typical	Maximum	Unit
Junction-to-Ambient Thermal Resistance ^a	$t \leq 10 \text{ s}$	$R_{\theta JA}$	76	94	$^{\circ}\text{C}/\text{W}$
	Steady State		115	145	
Junction-to-Ambient Thermal Resistance ^b	$t \leq 10 \text{ s}$	$R_{\theta JA}$	92	115	
	Steady State		135	175	
Junction-to-Case Thermal Resistance	Steady State	$R_{\theta JC}$	63	78	
Dual Operation					
Junction-to-Ambient Thermal Resistance ^a	$t \leq 10 \text{ s}$	$R_{\theta JA}$	79	97	$^{\circ}\text{C}/\text{W}$
	Steady State		118	148	
Junction-to-Ambient Thermal Resistance ^b	$t \leq 10 \text{ s}$	$R_{\theta JA}$	96	118	
	Steady State		138	180	
Junction-to-Case Thermal Resistance	Steady State	$R_{\theta JC}$	66	81	

a Surface mounted on FR-4 Board using 1 square inch pad size, 1oz copper

b Surface mounted on FR-4 board using minimum pad size, 1oz copper

c Pulse width < 380 μs , Duty Cycle < 2%

d Maximum junction temperature $T_J=150^{\circ}\text{C}$.

Electronics Characteristics (Ta=25°C, unless otherwise noted)

Parameter	Symbol	Test Conditions	Min	Typ	Max	Unit
OFF CHARACTERISTICS						
Drain-to-Source Breakdown Voltage	BV_{DSS}	$V_{GS} = 0\text{ V}, I_D = 250\mu\text{A}$	20			V
Zero Gate Voltage Drain Current	I_{DSS}	$V_{DS} = 16\text{ V}, V_{GS} = 0\text{ V}$			1	μA
Gate-to-source Leakage Current	I_{GSS}	$V_{DS} = 0\text{ V}, V_{GS} = \pm 10\text{ V}$			± 1	μA
ON CHARACTERISTICS						
Gate Threshold Voltage	$V_{GS(TH)}$	$V_{GS} = V_{DS}, I_D = 250\mu\text{A}$	0.5	0.7	1.0	V
Drain-to-source On-resistance ^{b, c}	$R_{DS(on)}$	$V_{GS} = 4.5\text{ V}, I_D = 6.3\text{ A}$	12	16	21	m Ω
		$V_{GS} = 3.8\text{ V}, I_D = 6.0\text{ A}$	13	17.5	22	
		$V_{GS} = 3.1\text{ V}, I_D = 6.0\text{ A}$	14	18	23	
		$V_{GS} = 2.5\text{ V}, I_D = 5.5\text{ A}$	15	20	26	
Forward Transconductance	g_{FS}	$V_{DS} = 5.0\text{ V}, I_D = 6.3\text{ A}$		16		S
CHARGES, CAPACITANCES AND GATE RESISTANCE						
Input Capacitance	C_{ISS}	$V_{GS} = 0\text{ V}, f = 1\text{ MHz},$ $V_{DS} = 10\text{ V}$		850		pF
Output Capacitance	C_{OSS}			127		
Reverse Transfer Capacitance	C_{RSS}			115		
Total Gate Charge	$Q_{G(TOT)}$	$V_{GS} = 4.5\text{ V}, V_{DD} = 10\text{ V},$ $I_D = 6.3\text{ A}$		10.9		nC
Threshold Gate Charge	$Q_{G(TH)}$			0.62		
Gate-to-Source Charge	Q_{GS}			1.92		
Gate-to-Drain Charge	Q_{GD}			2.0		
SWITCHING CHARACTERISTICS						
Turn-On Delay Time	$t_d(ON)$	$V_{GS} = 4.5\text{ V}, V_{DD} = 10\text{ V},$ $R_L = 2\Omega, R_G = 6\Omega$		22		ns
Rise Time	t_r			18		
Turn-Off Delay Time	$t_d(OFF)$			62		
Fall Time	t_f			28		
BODY DIODE CHARACTERISTICS						
Forward Voltage	V_{SD}	$V_{GS} = 0\text{ V}, I_S = 1.0\text{ A}$		0.65	1.5	V

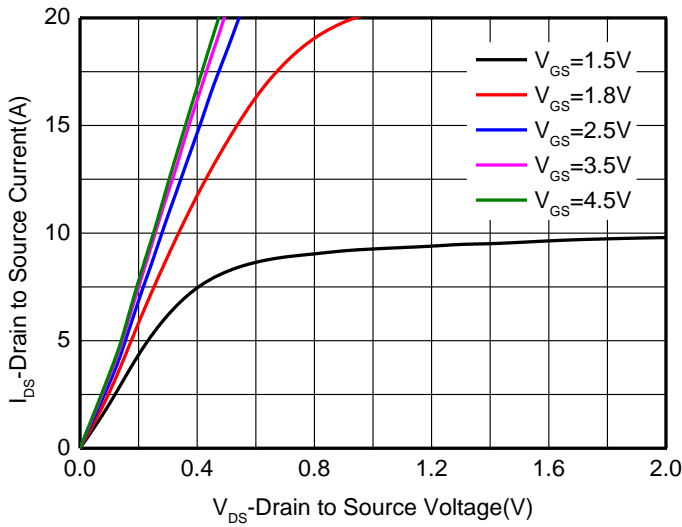
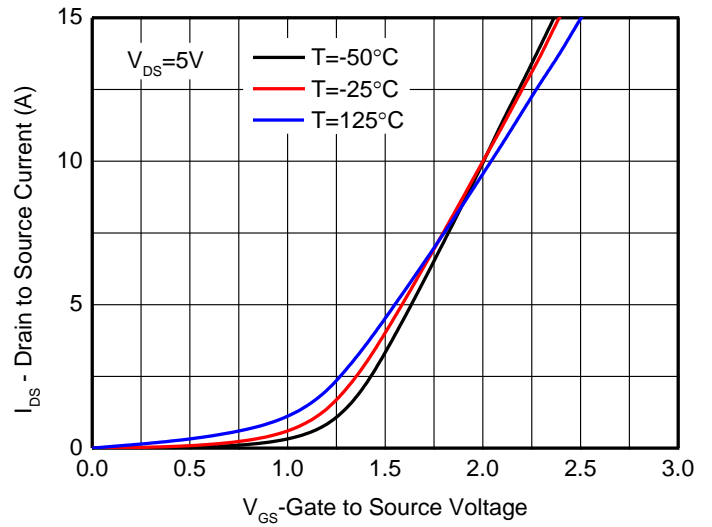
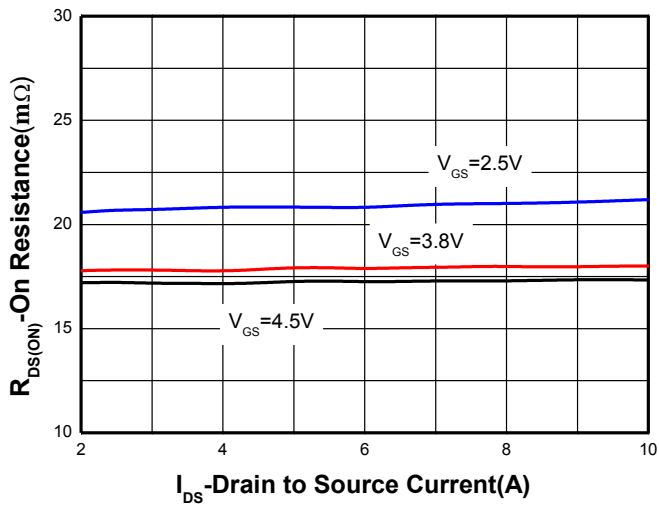
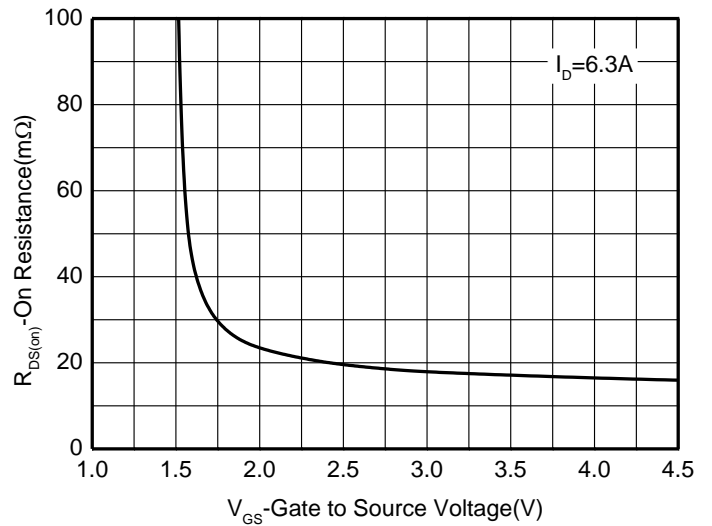
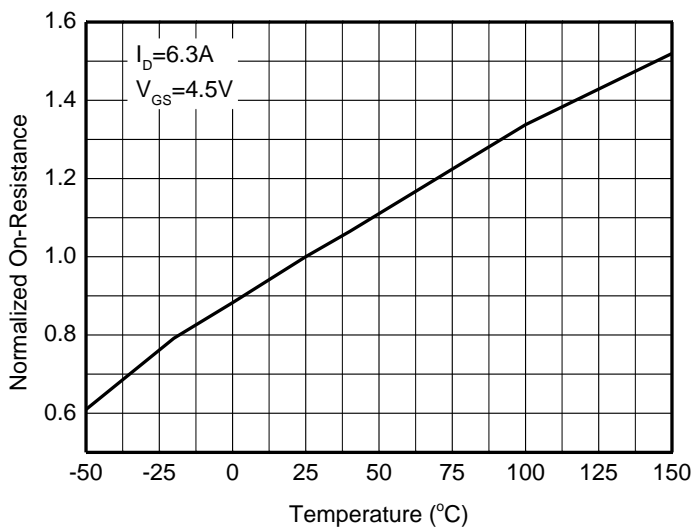
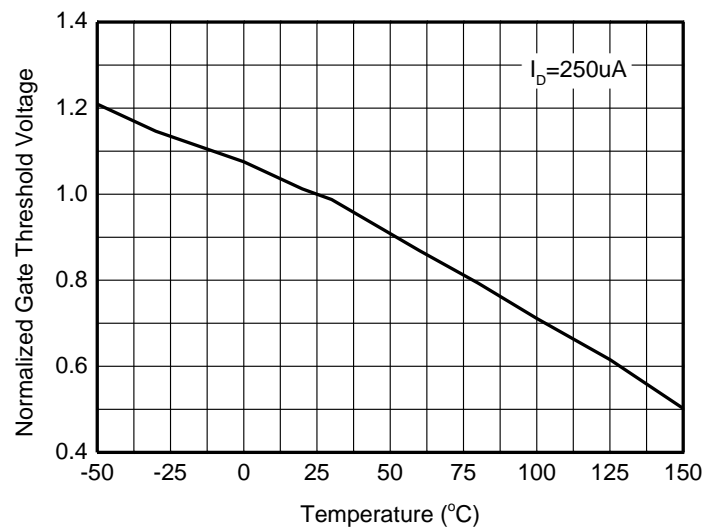
Typical Characteristics (Ta=25°C, unless otherwise noted)

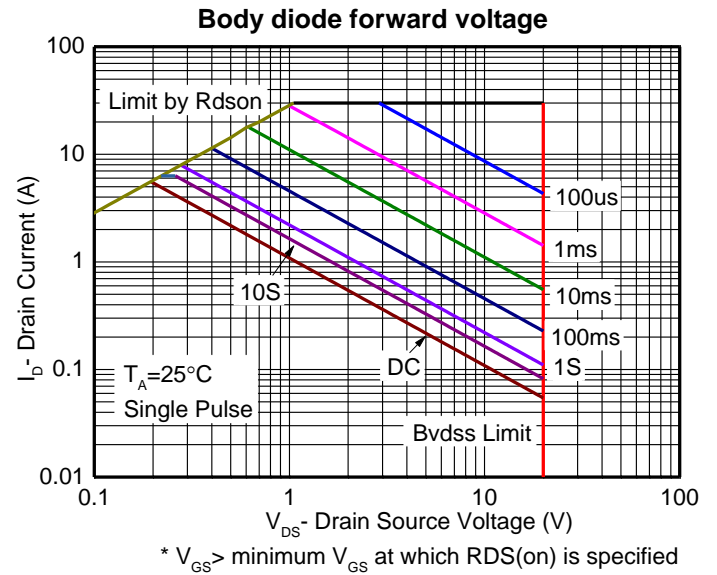
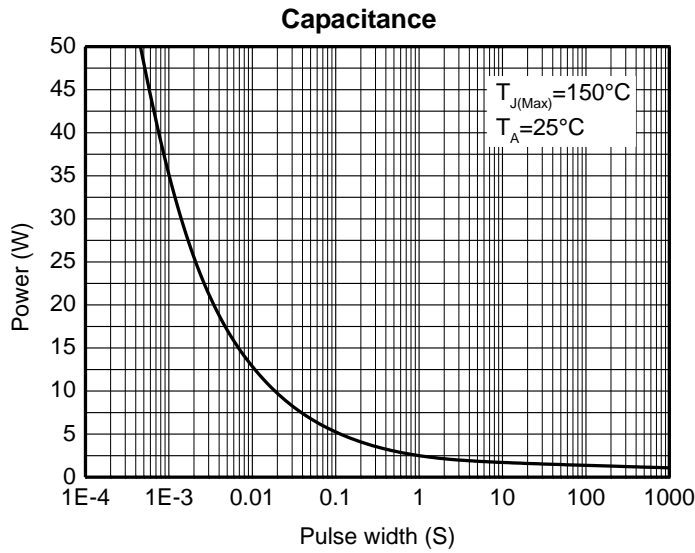
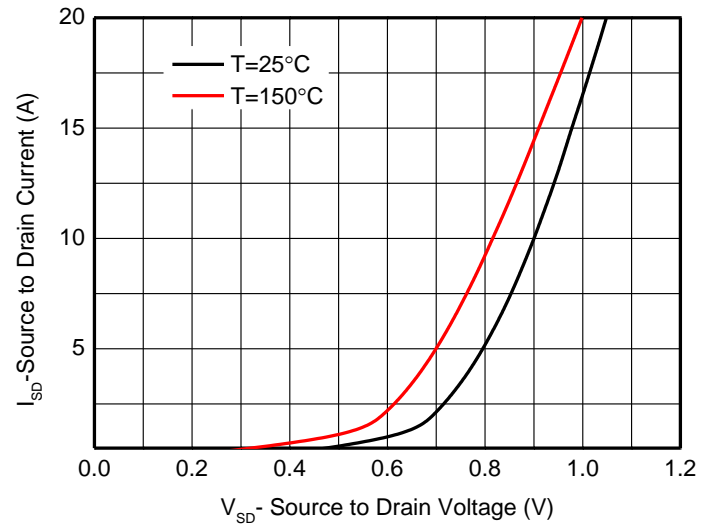
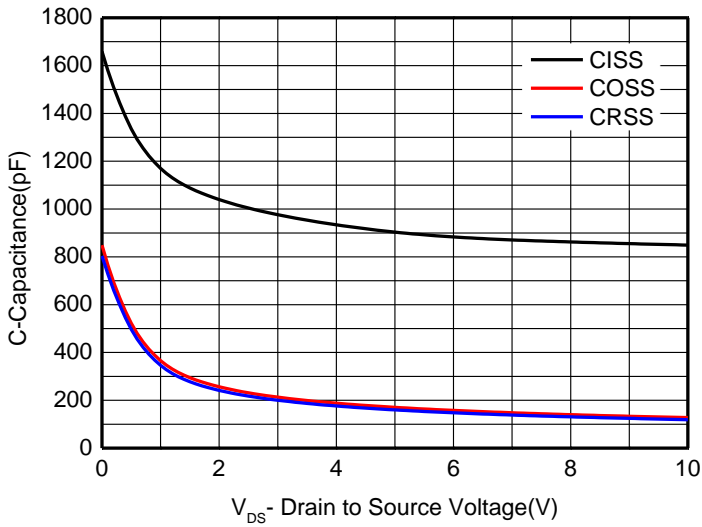
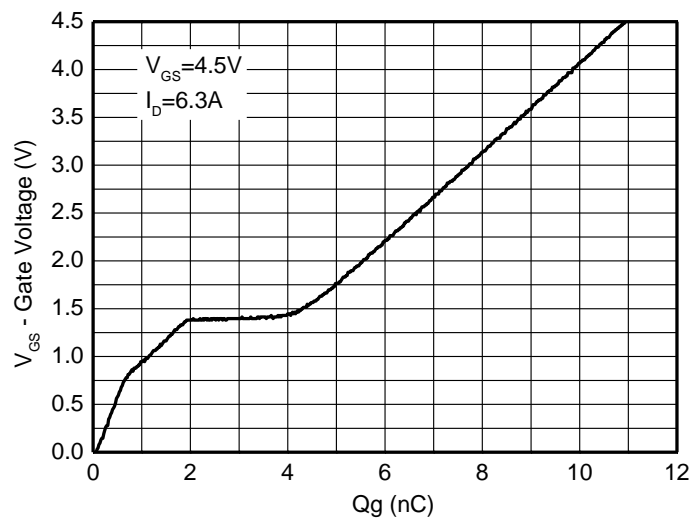
Output characteristics

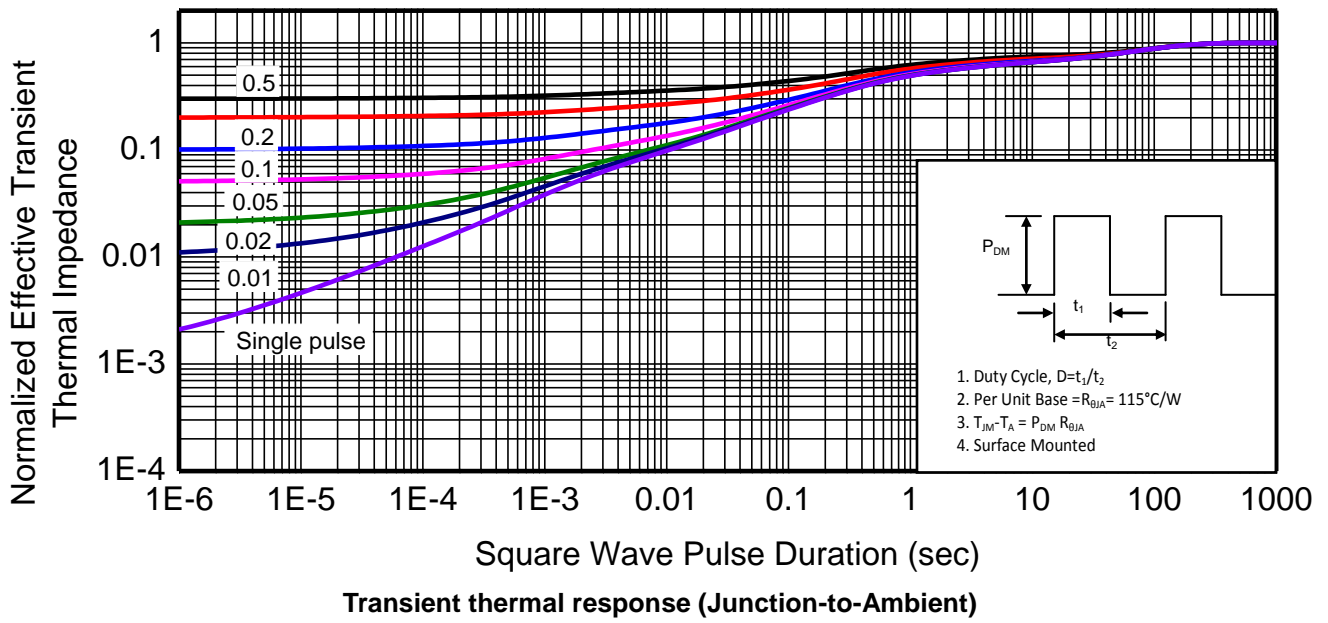
Transfer characteristics

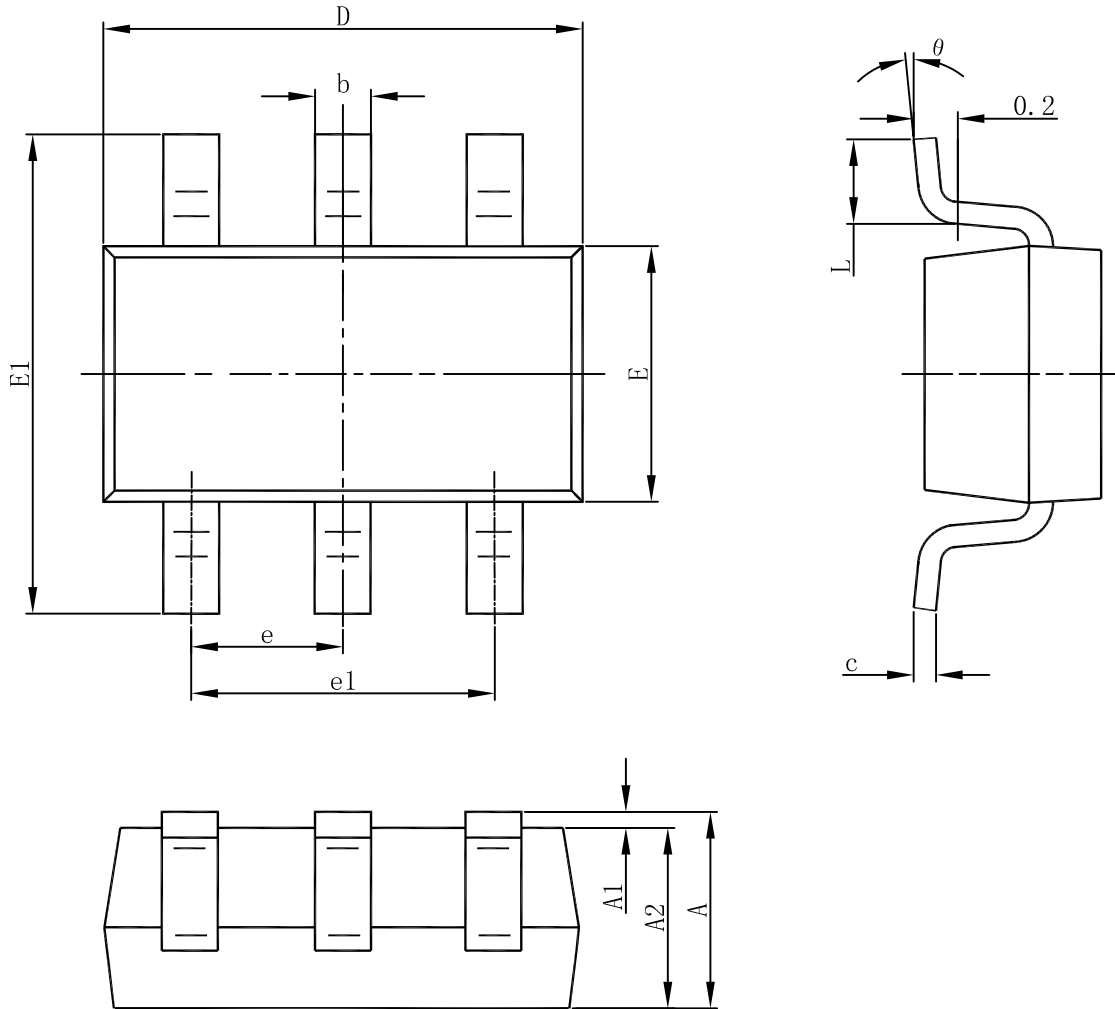
On-Resistance vs. Drain current

On-Resistance vs. Gate-to-Source voltage

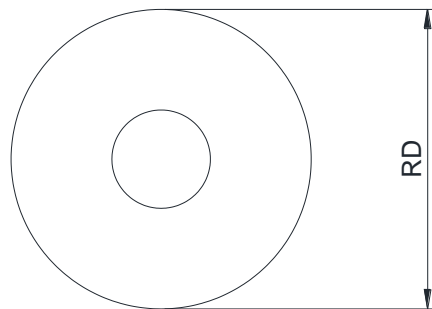
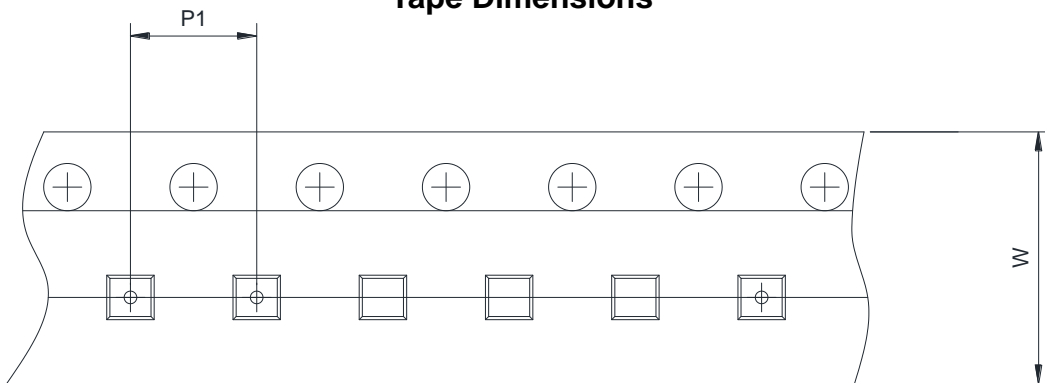
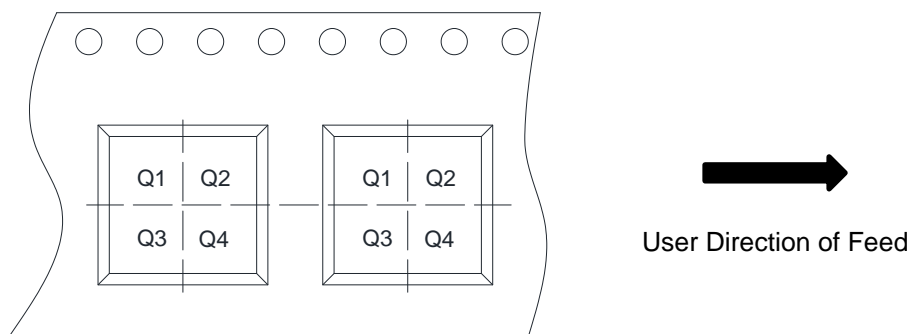
On-Resistance vs. Junction temperature

Threshold voltage vs. Temperature

Single pulse power
Safe operating power

Gate Charge Characteristics



Package outline dimensions
SOT-23-6

Symbol	Dimensions in Millimeters		
	Min.	Typ.	Max.
A	1.05	-	1.45
A1	0	-	0.15
A2	1.00	1.15	1.30
b	0.30	0.40	0.50
c	0.10	-	0.21
D	2.72	2.92	3.12
E1	2.60	2.80	3.00
E	1.40	1.60	1.80
e	0.85	0.95	1.05
e1	1.80	1.90	2.00
L	0.30	-	0.60
L1	0.25 BSC		
θ	0 °	-	8 °

TAPE AND REEL INFORMATION
Reel Dimensions

Tape Dimensions

Quadrant Assignments For PIN1 Orientation In Tape

RD	Reel Dimension	<input checked="" type="checkbox"/> 7inch	<input type="checkbox"/> 13inch
W	Overall width of the carrier tape	<input checked="" type="checkbox"/> 8mm	<input type="checkbox"/> 12mm <input type="checkbox"/> 16mm
P1	Pitch between successive cavity centers	<input type="checkbox"/> 2mm	<input checked="" type="checkbox"/> 4mm <input type="checkbox"/> 8mm
Pin1	Pin1 Quadrant	<input type="checkbox"/> Q1	<input type="checkbox"/> Q2 <input checked="" type="checkbox"/> Q3 <input type="checkbox"/> Q4

X-ON Electronics

Largest Supplier of Electrical and Electronic Components

Click to view similar products for [MOSFET](#) category:

Click to view products by [Will Semiconductor](#) manufacturer:

Other Similar products are found below :

[614233C](#) [648584F](#) [FDPF9N50NZ](#) [IRFD120](#) [IRFF430](#) [JANTX2N5237](#) [2N7000](#) [FCA20N60_F109](#) [FDZ595PZ](#) [2SK2267\(Q\)](#) [2SK2545\(Q,T\)](#)
[405094E](#) [423220D](#) [MIC4420CM-TR](#) [VN1206L](#) [614234A](#) [715780A](#) [SSM6J414TU,LF\(T](#) [751625C](#) [PSMN4R2-30MLD](#)
[TK31J60W5,S1VQ\(O](#) [2SK2614\(TE16L1,Q\)](#) [DMN1017UCP3-7](#) [EFC2J004NUZTDG](#) [FCAB21350L1](#) [P85W28HP2F-7071](#) [DMN1053UCP4-7](#)
[NTE2384](#) [NTE2969](#) [NTE6400A](#) [DMN61D9UWQ-13](#) [US6M2GTR](#) [DMN31D5UDJ-7](#) [SSM6P54TU,LF](#) [DMP22D4UFO-7B](#)
[IPS60R3K4CEAKMA1](#) [DMN1006UCA6-7](#) [DMN16M9UCA6-7](#) [STF5N65M6](#) [STU5N65M6](#) [C3M0021120D](#) [DMN13M9UCA6-7](#)
[BSS340NWH6327XTSA1](#) [MCM3400A-TP](#) [DMTH10H4M6SPS-13](#) [IPS60R1K0PFD7SAKMA1](#) [IPS60R360PFD7SAKMA1](#)
[IPS60R600PFD7SAKMA1](#) [IPS60R210PFD7SAKMA1](#) [DMN2990UFB-7B](#)