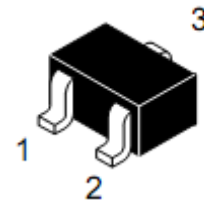
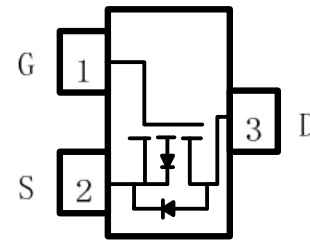

WPM1483
Single P-Channel, -12V, -3.5A, Power MOSFET
[Http://www.sh-willsemi.com](http://www.sh-willsemi.com)

V_{DS} (V)	Typical $R_{ds(on)}$ ()
-12	0.031 @ $V_{GS} = -4.5V$
	0.040 @ $V_{GS} = -2.5V$
	0.056 @ $V_{GS} = -1.8V$

SOT-23
Descriptions

The WPM1483 is P-Channel enhancement MOS Field Effect Transistor. Uses advanced trench technology and design to provide excellent $R_{DS(ON)}$ with low gate charge. This device is suitable for use in DC-DC conversion, power switch and charging circuit. Standard Product WPM1483 is Pb-free and Halogen-free.

Pin configuration (Top view)
Features

- Trench Technology
- Supper high density cell design
- Excellent ON resistance for higher DC current
- Extremely Low Threshold Voltage
- Small package SOT-23

Applications

- Driver for Relay, Solenoid, Motor, LED etc.
- DC-DC converter circuit
- Power Switch
- Load Switch
- Charging

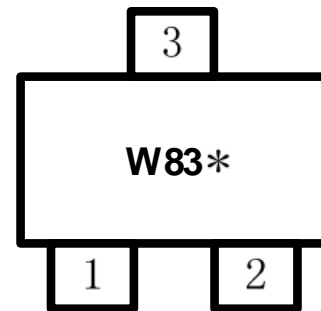
W=Willsemi
83= Device Code
***= Month (A-Z)**
Marking
Order information

Device	Package	Shipping
WPM1483 -3/TR	SOT-23	3000/Reel&Tape

Absolute Maximum ratings

Parameter		Symbol	10 S	Steady State	Unit
Drain-Source Voltage		V_{DS}	-12		V
Gate-Source Voltage		V_{GS}	± 8		
Continuous Drain Current ^{a d}	$T_A=25^\circ\text{C}$	I_D	-3.5	-3.2	A
	$T_A=70^\circ\text{C}$		-2.9	-2.5	
Maximum Power Dissipation ^{a d}	$T_A=25^\circ\text{C}$	P_D	0.74	0.57	W
	$T_A=70^\circ\text{C}$		0.47	0.37	
Continuous Drain Current ^b	$T_A=25^\circ\text{C}$	I_D	-3.4	-2.9	A
	$T_A=70^\circ\text{C}$		-2.7	-2.3	
Maximum Power Dissipation ^b	$T_A=25^\circ\text{C}$	P_D	0.67	0.49	W
	$T_A=70^\circ\text{C}$		0.43	0.31	
Pulsed Drain Current ^c		I_{DM}	-10		A
Operating Junction Temperature		T_J	150		$^\circ\text{C}$
Lead Temperature		T_L	260		$^\circ\text{C}$
Storage Temperature Range		T_{stg}	-55 to 150		$^\circ\text{C}$

Thermal resistance ratings

Parameter		Symbol	Typical	Maximum	Unit
Junction-to-Ambient Thermal Resistance ^a	t 10 s	R_{JA}	140	168	$^\circ\text{C}/\text{W}$
	Steady State		180	216	
Junction-to-Ambient Thermal Resistance ^b	t 10 s	R_{JA}	155	186	
	Steady State		212	254	
Junction-to-Case Thermal Resistance		R_{JC}	63	78	

a Surface mounted on FR-4 Board using 1 square inch pad size, 1oz copper

b Surface mounted on FR-4 board using minimum pad size, 1oz copper

c Pulse width<380 μs , Duty Cycle<2%

d Maximum junction temperature $T_J=150^\circ\text{C}$.

Electronics Characteristics (Ta=25°C, unless otherwise noted)

Parameter	Symbol	Test Conditions	Min	Typ	Max	Unit
OFF CHARACTERISTICS						
Drain-to-Source Breakdown Voltage	BV_{DSS}	$V_{GS} = 0\text{ V}, I_D = -250\mu\text{A}$	-12			V
Zero Gate Voltage Drain Current	I_{DSS}	$V_{DS} = -10\text{ V}, V_{GS} = 0\text{ V}$			-1	μA
Gate-to-source Leakage Current	I_{GSS}	$V_{DS} = 0\text{ V}, V_{GS} = \pm 8\text{ V}$			± 1	μA
ON CHARACTERISTICS						
Gate Threshold Voltage	$V_{GS(TH)}$	$V_{GS} = V_{DS}, I_D = -250\mu\text{A}$	-0.45	-0.55	-0.85	V
Drain-to-source On-resistance ^{b, c}	$R_{DS(on)}$	$V_{GS} = -4.5\text{ V}, I_D = -3.5\text{ A}$		31	37	m
		$V_{GS} = -2.5\text{ V}, I_D = -3.0\text{ A}$		40	55	
		$V_{GS} = -1.8\text{ V}, I_D = -2.0\text{ A}$		56	88	
Forward Trans conductance	g_{fs}	$V_{DS} = -5.0\text{ V}, I_D = -2.0\text{ A}$		8.5		S
CAPACITANCES, CHARGES						
Input Capacitance	C_{ISS}	$V_{GS} = 0\text{ V},$ $f = 1.0\text{ MHz},$ $V_{DS} = -10\text{ V}$		1152		pF
Output Capacitance	C_{OSS}			253		
Reverse Transfer Capacitance	C_{RSS}			236		
Total Gate Charge	$Q_{G(TOT)}$	$V_{GS} = -4.5\text{ V},$ $V_{DD} = -10\text{ V},$ $I_D = -3.5\text{ A}$		14.6		nC
Threshold Gate Charge	$Q_{G(TH)}$			1.35		
Gate-to-Source Charge	Q_{GS}			2.3		
Gate-to-Drain Charge	Q_{GD}			5.7		
SWITCHING CHARACTERISTICS						
Turn-On Delay Time	$t_d(ON)$	$V_{GS} = -4.5\text{ V},$ $V_{DD} = -10\text{ V},$ $R_L = 3\ \Omega,$ $R_G = 6\ \Omega$		26		ns
Rise Time	t_r			23		
Turn-Off Delay Time	$t_d(OFF)$			68		
Fall Time	t_f			45		
BODY DIODE CHARACTERISTICS						
Forward Voltage	V_{SD}	$V_{GS} = 0\text{ V}, I_S = -1.0\text{ A}$		-0.8	-1.5	V

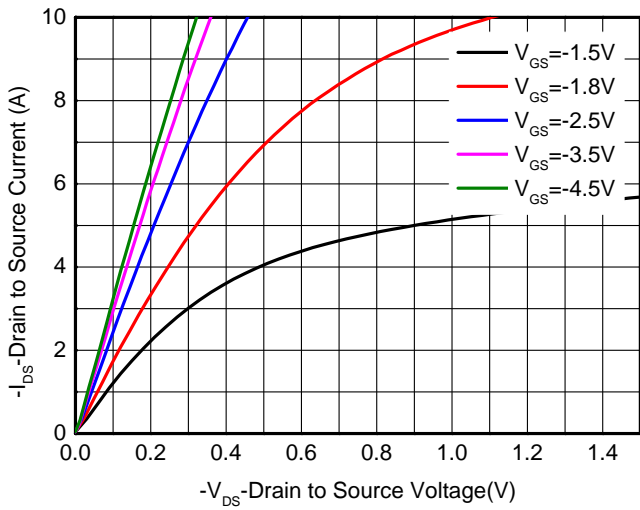
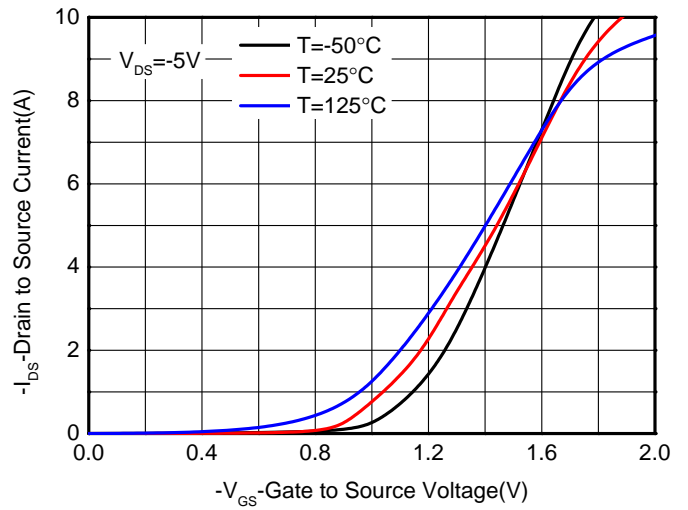
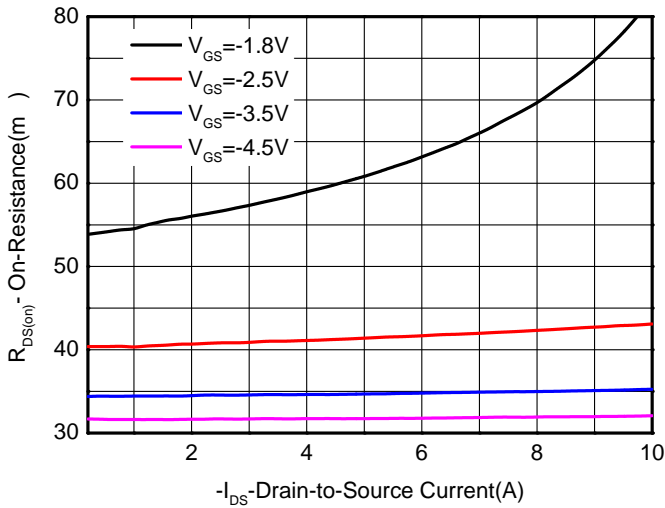
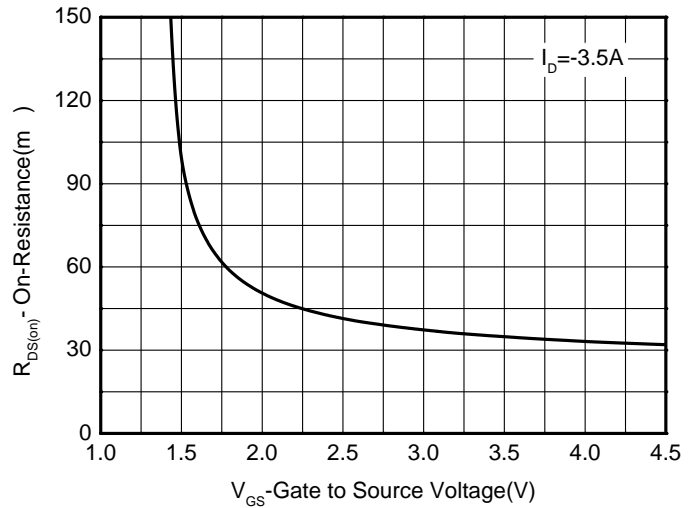
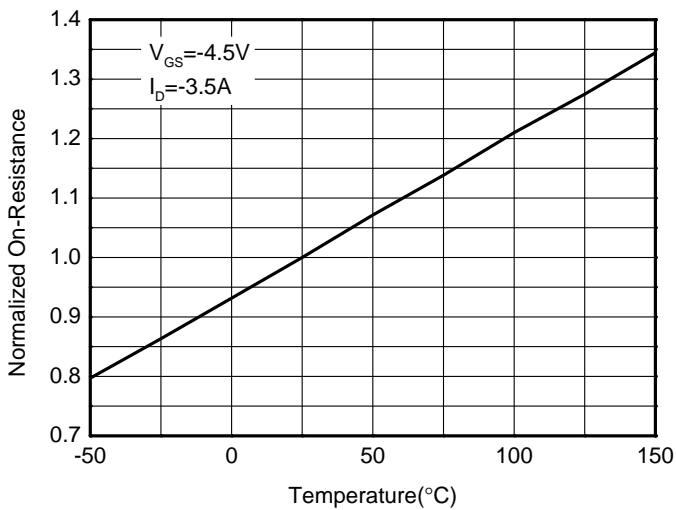
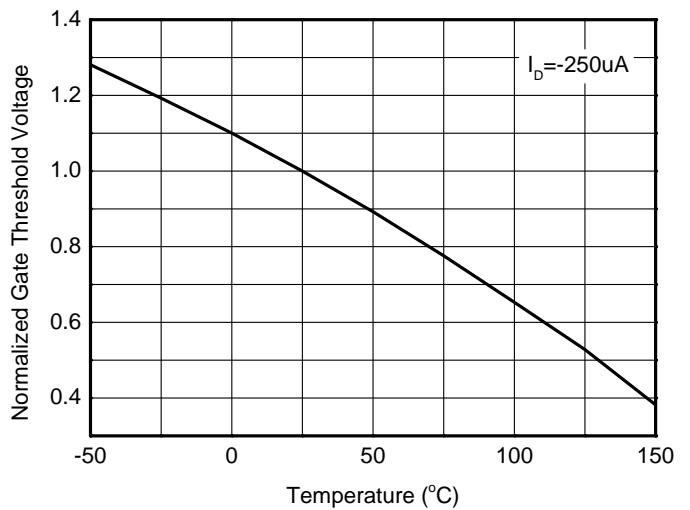
Typical Characteristics (Ta=25°C, unless otherwise noted)

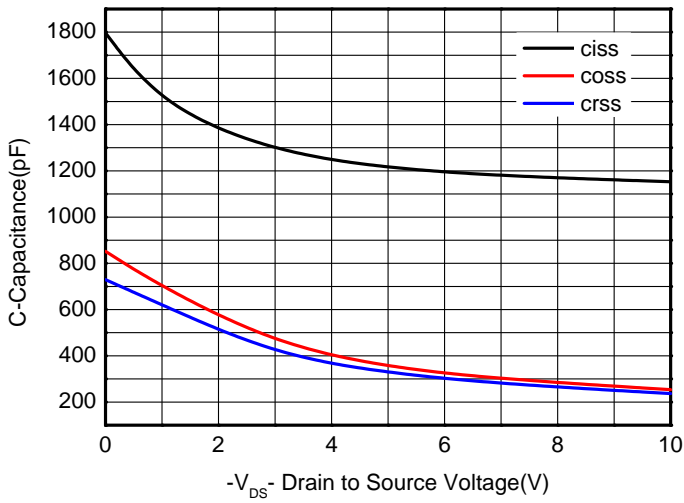
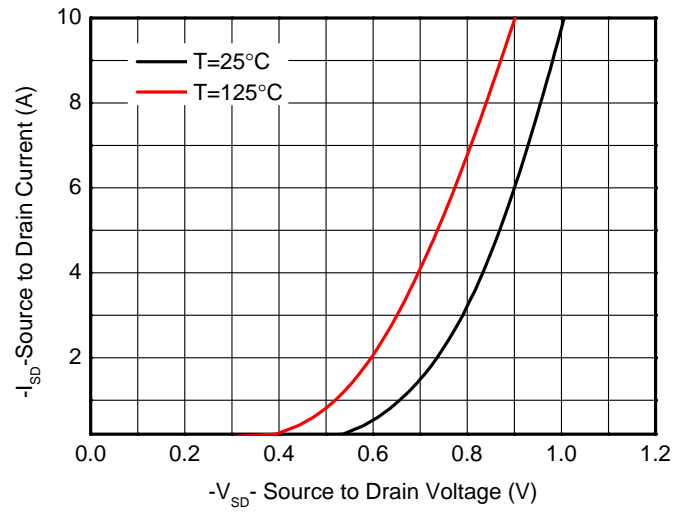
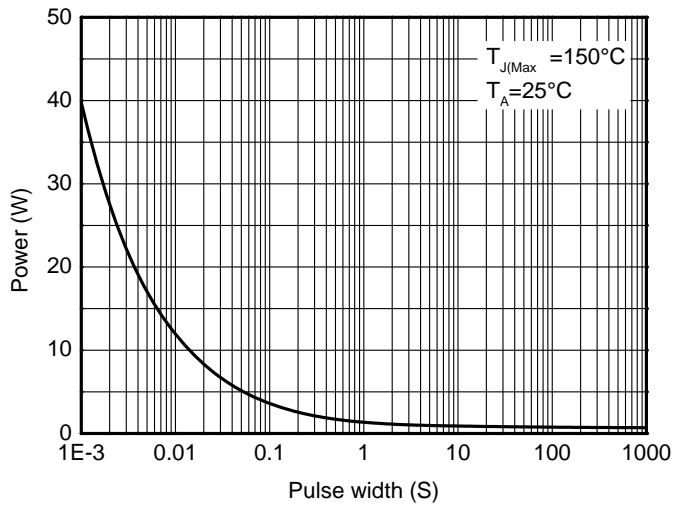
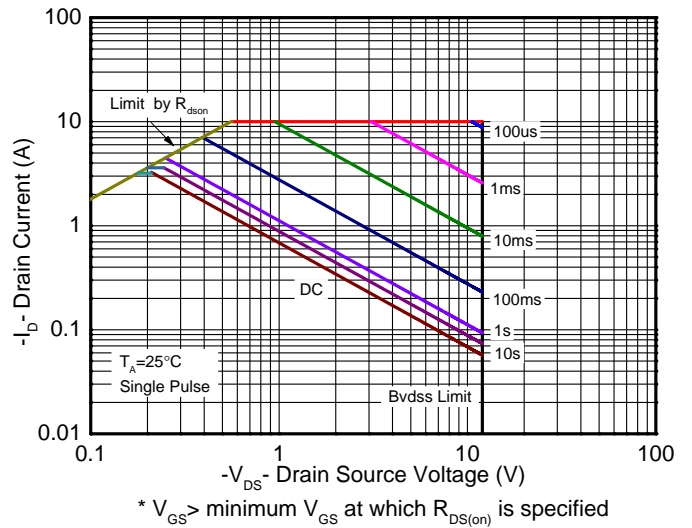
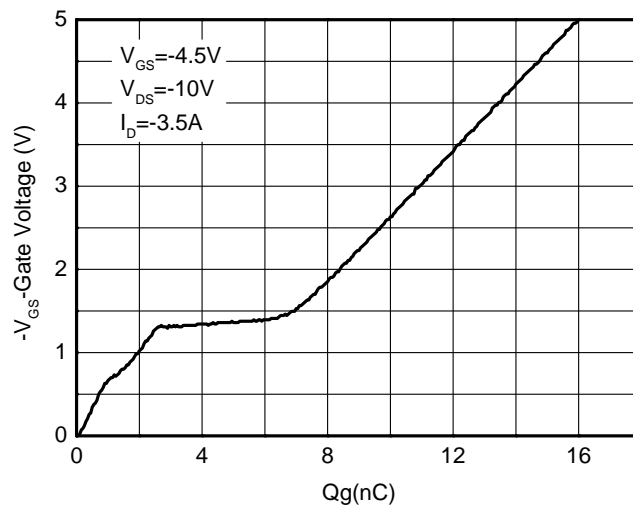
Output characteristics

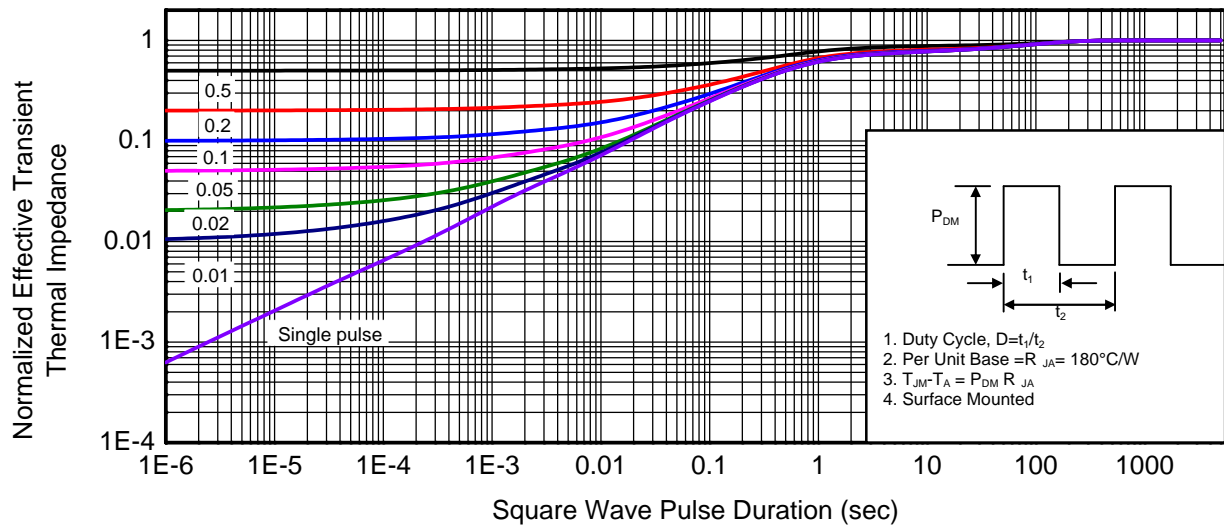
Transfer characteristics

On-Resistance vs. Drain current

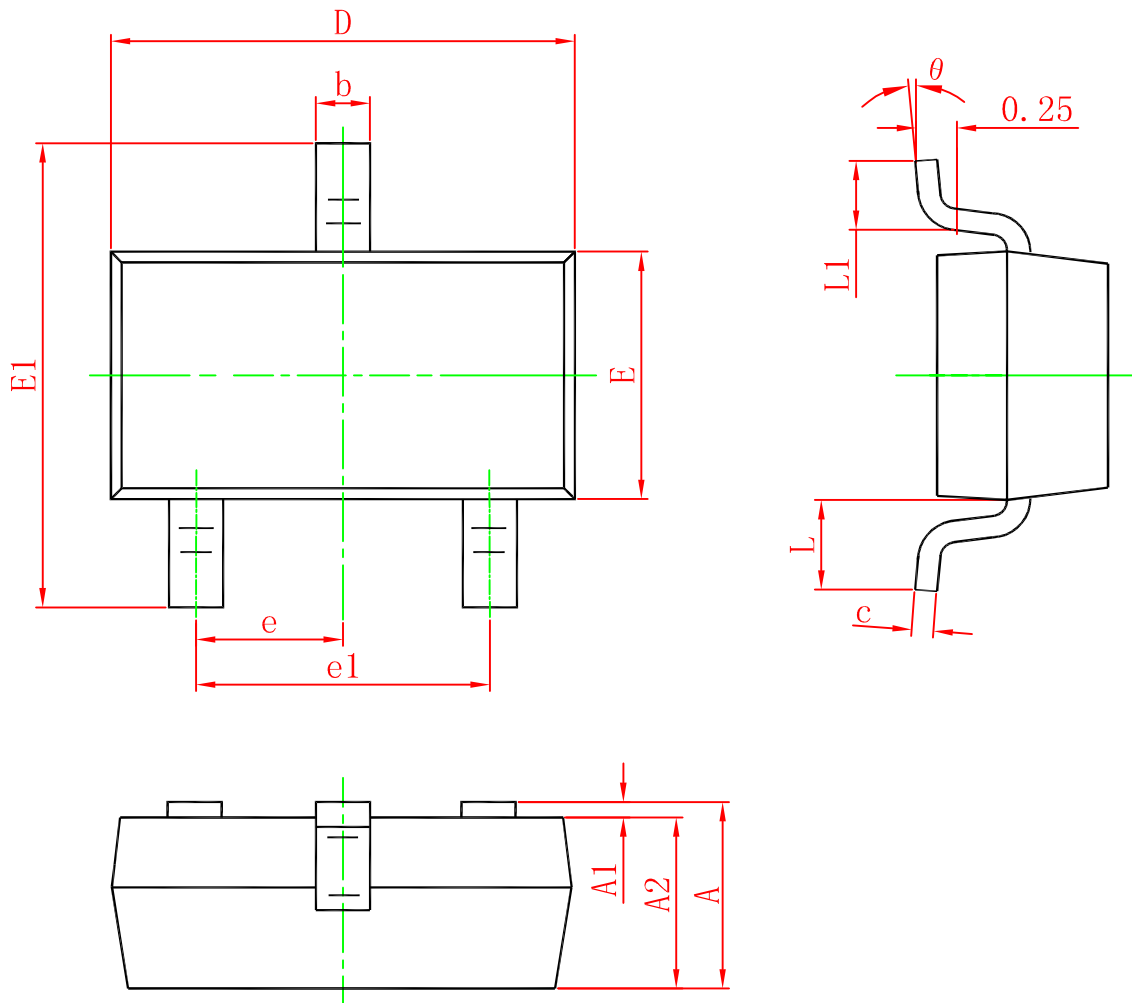
On-Resistance vs. Gate-to-Source voltage

On-Resistance vs. Junction temperature

Threshold voltage vs. Temperature

Capacitance

Body diode forward voltage

Single pulse power

Safe operating power

Gate charge Characteristics



Transient thermal response (Junction-to-Ambient)

Package outline dimensions
SOT-23

Symbol	Dimensions In Millimeters		Dimensions In Inches	
	Min.	Max.	Min.	Max.
A	0.900	1.150	0.035	0.045
A1	0.000	0.100	0.000	0.004
A2	0.900	1.050	0.035	0.041
b	0.300	0.500	0.012	0.020
c	0.080	0.150	0.003	0.006
D	2.800	3.000	0.110	0.118
E	1.200	1.400	0.047	0.055
E1	2.250	2.550	0.089	0.100
e	0.950 TYP.		0.037 TYP.	
e1	1.800	2.000	0.071	0.079
L	0.550 REF.		0.022 REF.	
L1	0.300	0.500	0.012	0.020
θ	0°	8°	0°	8°

X-ON Electronics

Largest Supplier of Electrical and Electronic Components

Click to view similar products for [MOSFET](#) category:

Click to view products by [Will Semiconductor](#) manufacturer:

Other Similar products are found below :

[614233C](#) [648584F](#) [FDPF9N50NZ](#) [IRFD120](#) [IRFF430](#) [JANTX2N5237](#) [2N7000](#) [FCA20N60_F109](#) [FDZ595PZ](#) [2SK2267\(Q\)](#) [2SK2545\(Q,T\)](#)
[405094E](#) [423220D](#) [MIC4420CM-TR](#) [VN1206L](#) [614234A](#) [715780A](#) [SSM6J414TU,LF\(T](#) [751625C](#) [PSMN4R2-30MLD](#)
[TK31J60W5,S1VQ\(O](#) [2SK2614\(TE16L1,Q\)](#) [DMN1017UCP3-7](#) [EFC2J004NUZTDG](#) [FCAB21350L1](#) [P85W28HP2F-7071](#) [DMN1053UCP4-7](#)
[NTE2384](#) [NTE2969](#) [NTE6400A](#) [DMN61D9UWQ-13](#) [US6M2GTR](#) [DMN31D5UDJ-7](#) [SSM6P54TU,LF](#) [DMP22D4UFO-7B](#)
[IPS60R3K4CEAKMA1](#) [DMN1006UCA6-7](#) [DMN16M9UCA6-7](#) [STF5N65M6](#) [STU5N65M6](#) [C3M0021120D](#) [DMN13M9UCA6-7](#)
[BSS340NWH6327XTSA1](#) [MCM3400A-TP](#) [DMTH10H4M6SPS-13](#) [IPS60R1K0PFD7SAKMA1](#) [IPS60R360PFD7SAKMA1](#)
[IPS60R600PFD7SAKMA1](#) [IPS60R210PFD7SAKMA1](#) [DMN2990UFB-7B](#)