

WPM1485
Single P-Channel, -12V, -7.4A, Power MOSFET
[Http://www.willsemi.com](http://www.willsemi.com)

V _{DS} (V)	R _{ds(on)} (Ω)
-12	0.016@ V _{GS} =-4.5V
	0.022@ V _{GS} =-2.5V
	0.032@ V _{GS} =-1.8V



DFN2×2-6L

Descriptions

The WPM1485 is P-Channel enhancement MOS Field Effect Transistor. Uses advanced trench technology and design to provide excellent R_{DS(ON)} with low gate charge. This device is suitable for use in DC-DC conversion, power switch and charging circuit. Standard Product WPM1485 is Pb-free and Halogen-free.

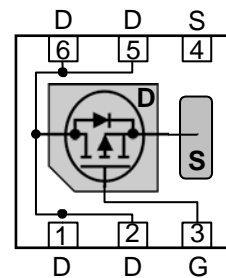
Pin configuration (Top view)
Features

- Trench Technology
- Supper high density cell design
- Excellent ON resistance for higher DC current
- Extremely Low Threshold Voltage
- Small package DFN2×2-6L

Applications

- Driver for Relay, Solenoid, Motor, LED etc.
- DC-DC converter circuit
- Power Switch
- Load Switch
- Charging

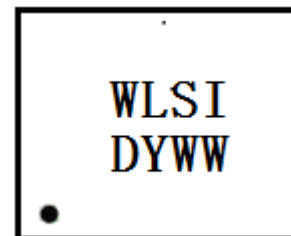

WLSI = Willsemi
 D = Device Code
 YY = Year
 WW = Week

Marking
Order information

Device	Package	Shipping
WPM1485-6/TR	DFN2×2-6L	3000/Reel&Tape

Absolute Maximum ratings

Parameter		Symbol	10 S	Steady State	Unit
Drain-Source Voltage		V_{DS}	-12		V
Gate-Source Voltage		V_{GS}	± 8		
Continuous Drain Current ^a	$T_A=25^\circ\text{C}$	I_D	-7.4	-6.4	A
	$T_A=70^\circ\text{C}$		-5.9	-5.1	
Maximum Power Dissipation ^a	$T_A=25^\circ\text{C}$	P_D	1.8	1.3	W
	$T_A=70^\circ\text{C}$		1.1	0.8	
Continuous Drain Current ^b	$T_A=25^\circ\text{C}$	I_D	-5.7	-4.6	A
	$T_A=70^\circ\text{C}$		-4.5	-3.6	
Maximum Power Dissipation ^b	$T_A=25^\circ\text{C}$	P_D	1.0	0.6	W
	$T_A=70^\circ\text{C}$		0.6	0.4	
Pulsed Drain Current ^c		I_{DM}	-30		A
Operating Junction Temperature		T_J	-55~+150		$^\circ\text{C}$
Lead Temperature		T_L	260		$^\circ\text{C}$
Storage Temperature Range		T_{stg}	-55 to 150		$^\circ\text{C}$

Thermal resistance ratings

Parameter		Symbol	Typical	Maximum	Unit
Junction-to-Ambient Thermal Resistance ^a	$t \leq 10 \text{ s}$	$R_{\theta JA}$	55	69	$^\circ\text{C/W}$
	Steady State		70	91	
Junction-to-Ambient Thermal Resistance ^b	$t \leq 10 \text{ s}$	$R_{\theta JA}$	88	115	
	Steady State		125	179	
Junction-to-Case Thermal Resistance		$R_{\theta JC}$	34	44	

a Surface mounted on FR-4 Board using 1 square inch pad size, 1oz copper

b Surface mounted on FR-4 board using minimum pad size, 1oz copper

c Pulse width<380 μs , Duty Cycle<2%

d Maximum junction temperature $T_J=150^\circ\text{C}$.

Electronics Characteristics (Ta=25°C, unless otherwise noted)

Parameter	Symbol	Test Conditions	Min	Typ	Max	Unit
OFF CHARACTERISTICS						
Drain-to-Source Breakdown Voltage	BV _{DSS}	V _{GS} = 0 V, I _D = -250uA	-12			V
Zero Gate Voltage Drain Current	I _{DSS}	V _{DS} = -10V, V _{GS} = 0V			-1	uA
Gate-to-source Leakage Current	I _{GSS}	V _{DS} = 0 V, V _{GS} = ±8V			±100	nA
ON CHARACTERISTICS						
Gate Threshold Voltage	V _{GS(TH)}	V _{GS} = V _{DS} , I _D = -250uA	-0.45	-0.60	-0.95	V
Drain-to-source On-resistance ^{b, c}	R _{DS(on)}	V _{GS} = -4.5V, I _D = -7.4A		16	19	mΩ
		V _{GS} = -4V, I _D = -7A		17	20	
		V _{GS} = -2.5V, I _D = -6.5A		22	25	
		V _{GS} = -1.8V, I _D = -2.3A		32	50	
Forward Transconductance	g _{FS}	V _{DS} = -5.0V, I _D = -7.4A		21		S
CAPACITANCES, CHARGES						
Input Capacitance	C _{ISS}	V _{GS} = 0 V, f = 1.0 MHz, V _{DS} = -10 V		2620		pF
Output Capacitance	C _{OSS}			570		
Reverse Transfer Capacitance	C _{RSS}			530		
Total Gate Charge	Q _{G(TOT)}	V _{GS} = -4.5 V, V _{DS} = -6.0 V, I _D = -7.4A		30.75		nC
Threshold Gate Charge	Q _{G(TH)}			1.90		
Gate-to-Source Charge	Q _{GS}			6.10		
Gate-to-Drain Charge	Q _{GD}			7.60		
SWITCHING CHARACTERISTICS						
Turn-On Delay Time	td(ON)	V _{GS} = -4.5 V, V _{DD} = -6.0 V, I _D = -7.4A, R _G = 6 Ω		22		ns
Rise Time	tr			40		
Turn-Off Delay Time	td(OFF)			90		
Fall Time	tf			65		
BODY DIODE CHARACTERISTICS						
Forward Voltage	V _{SD}	V _{GS} = 0 V, I _S = -8.0A		-0.88	-1.5	V

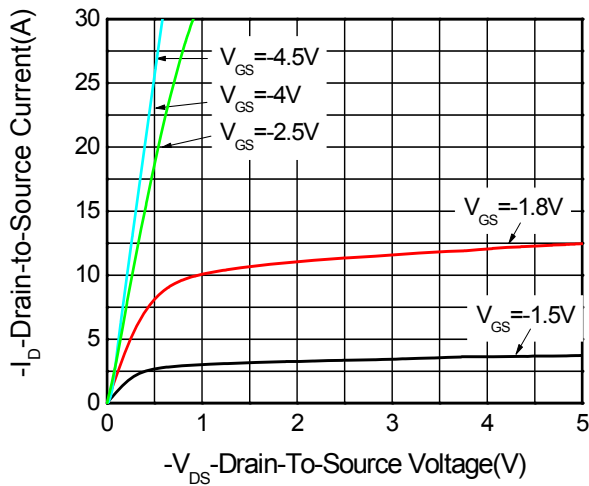
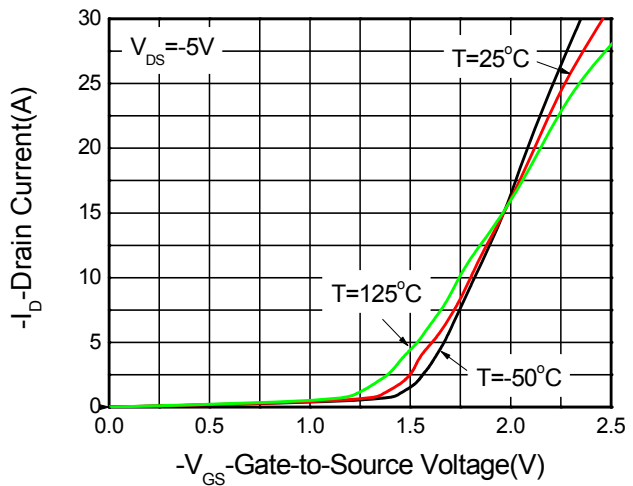
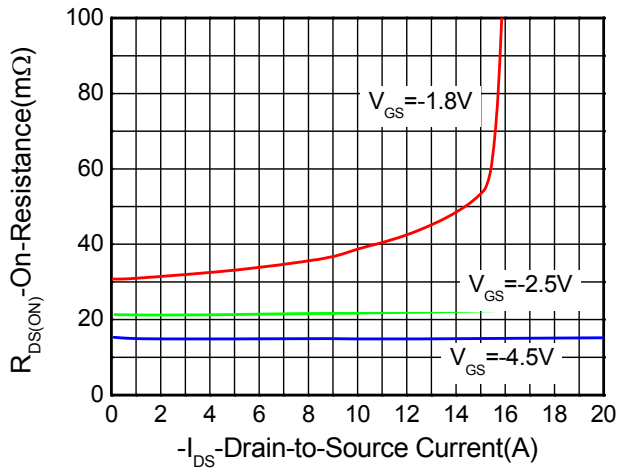
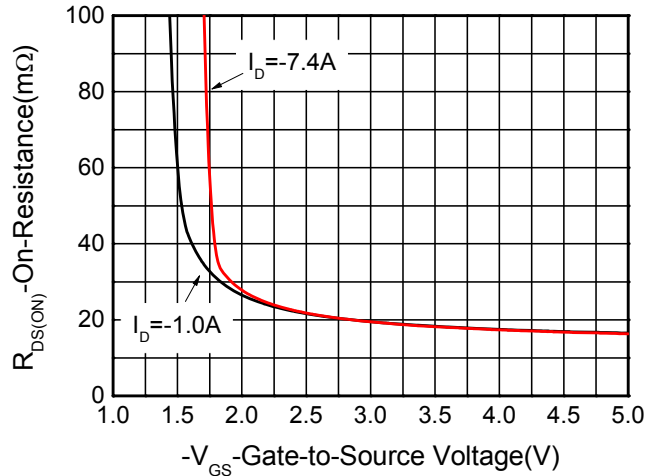
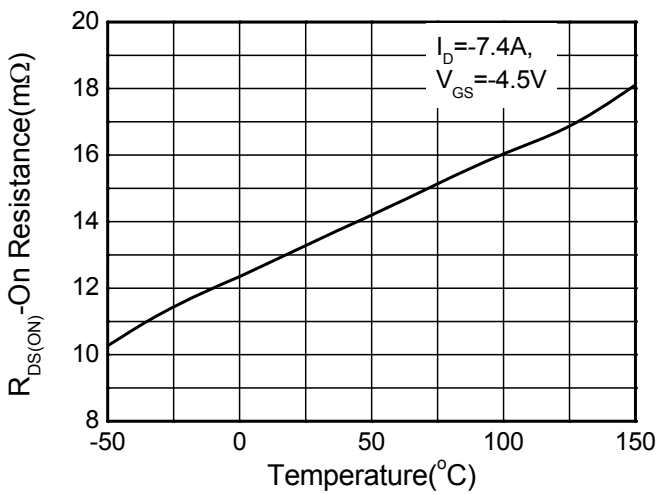
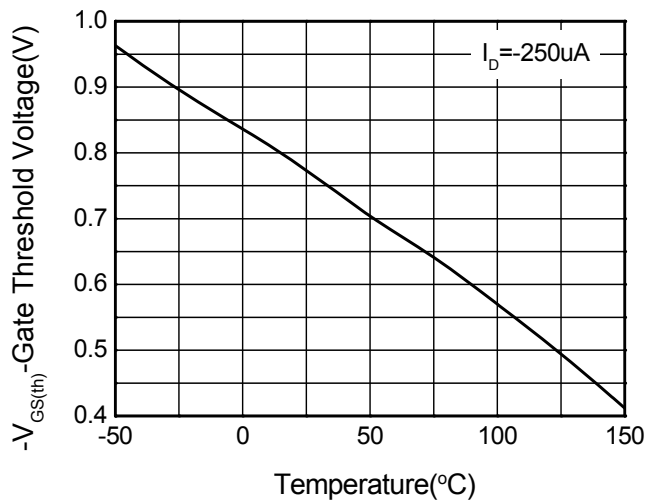
Typical Characteristics (Ta=25°C, unless otherwise noted)

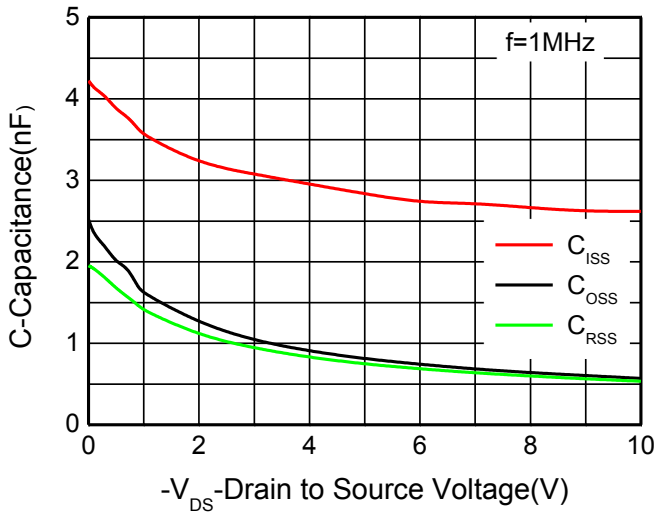
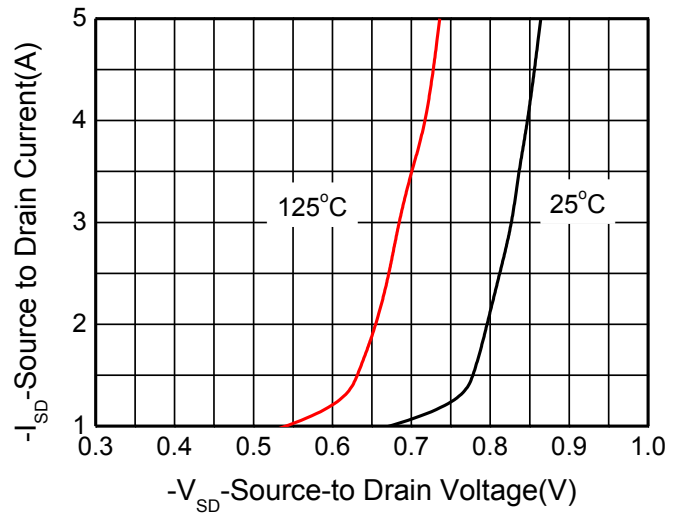
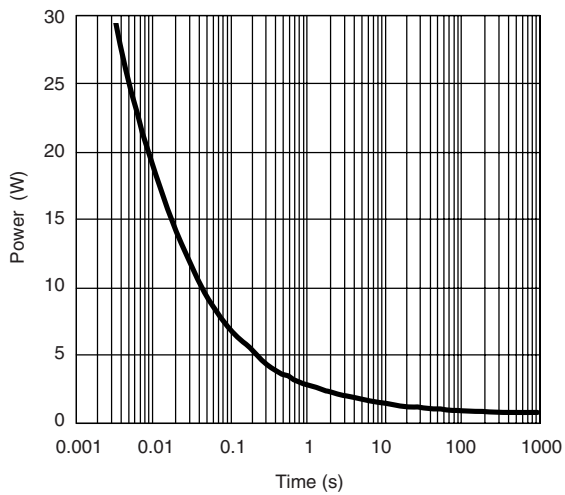
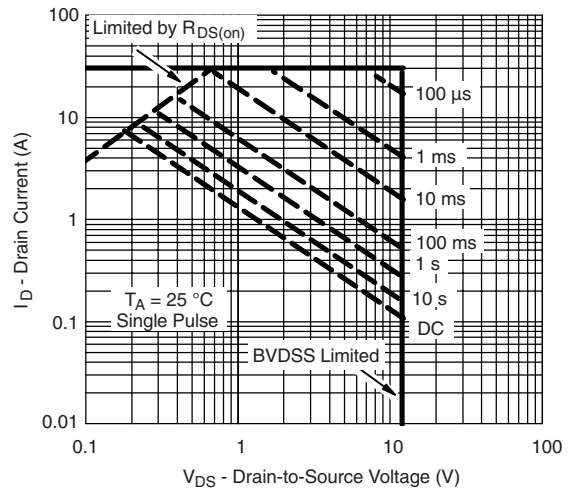
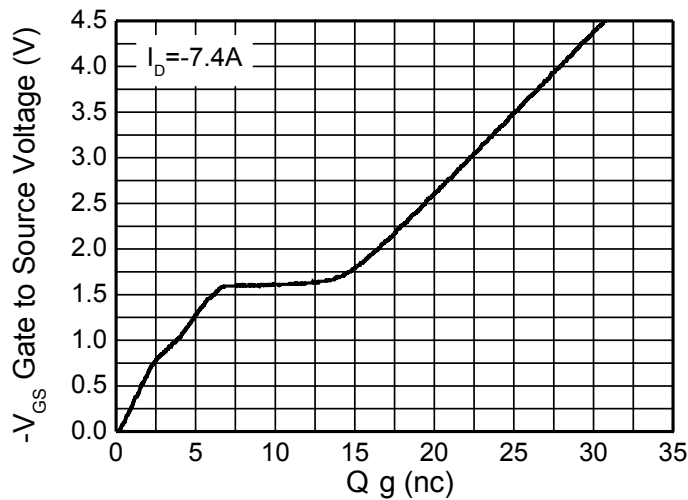
Output characteristics

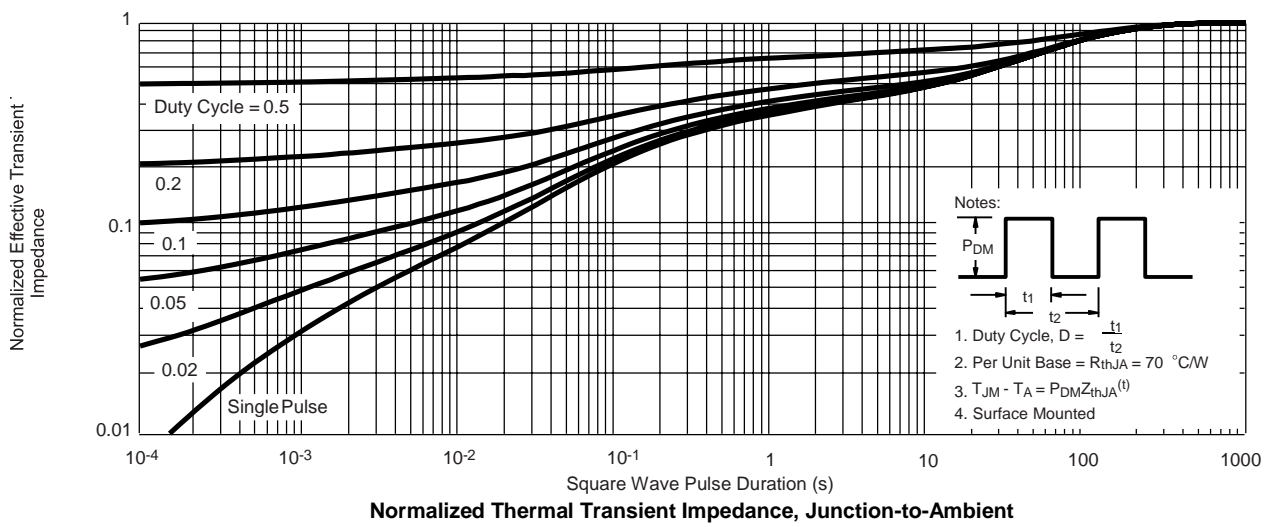
Transfer characteristics

On-Resistance vs. Drain current

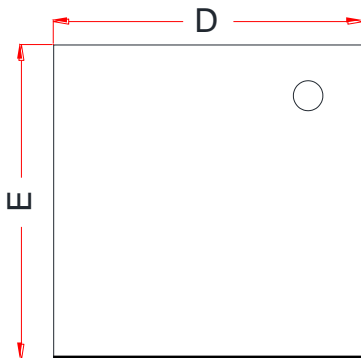
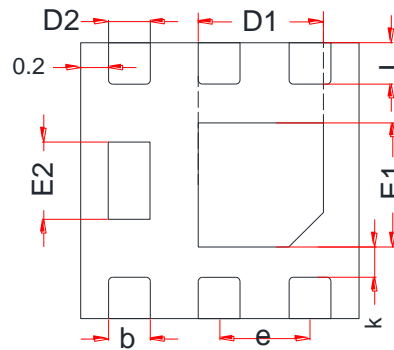
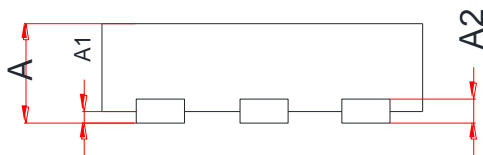
On-Resistance vs. Gate-to-Source voltage

On-Resistance vs. Junction temperature

Threshold voltage vs. Temperature



Capacitance

Body diode forward voltage

Single Pulse Power, Junction-to-Ambient

Safe Operating Area, Junction-to-Ambient

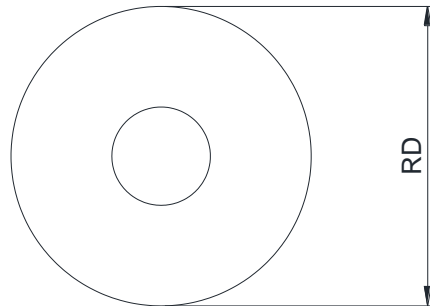
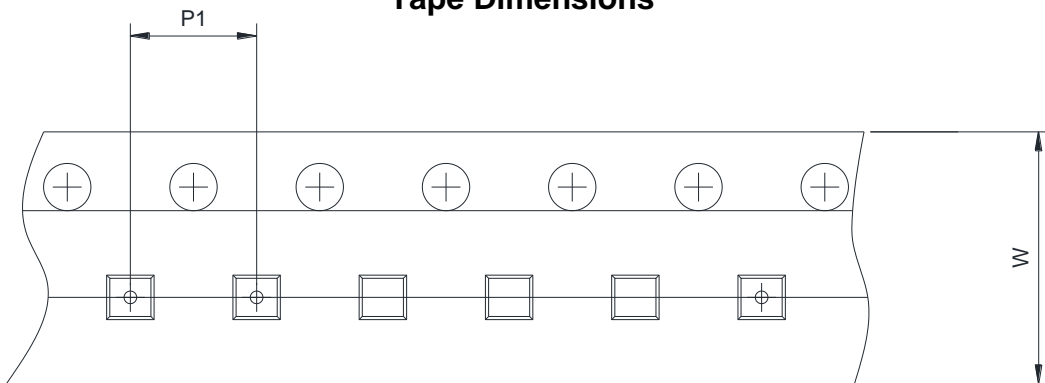
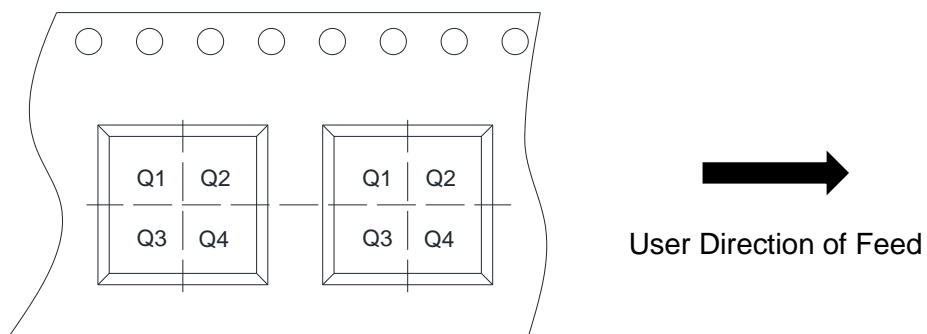
Gate Charge Characteristics



Transient thermal response (Junction-to-Ambient)

PACKAGE OUTLINE DIMENSIONS
DFN2x2-6L

TOP VIEW

BOTTOM VIEW

SIDE VIEW

Symbol	Dimensions in Millimeters		
	Min.	Typ.	Max.
A	0.70	0.75	0.85
A1	0.00	0.02	0.05
A2	0.20 Ref.		
b	0.25	0.30	0.35
D	1.95	2.00	2.05
D1	0.85	0.90	0.95
D2	0.25	0.30	0.35
E	1.95	2.00	2.05
E1	0.75	0.80	0.85
E2	0.56 Ref.		
e	0.65 BSC.		
L	0.30	0.35	0.40
K	0.20	-	-

TAPE AND REEL INFORMATION
Reel Dimensions

Tape Dimensions

Quadrant Assignments For PIN1 Orientation In Tape

RD	Reel Dimension	<input checked="" type="checkbox"/> 7inch	<input type="checkbox"/> 13inch
W	Overall width of the carrier tape	<input checked="" type="checkbox"/> 8mm	<input type="checkbox"/> 12mm <input type="checkbox"/> 16mm
P1	Pitch between successive cavity centers	<input type="checkbox"/> 2mm	<input checked="" type="checkbox"/> 4mm <input type="checkbox"/> 8mm
Pin1	Pin1 Quadrant	<input checked="" type="checkbox"/> Q1	<input type="checkbox"/> Q2 <input type="checkbox"/> Q3 <input type="checkbox"/> Q4

X-ON Electronics

Largest Supplier of Electrical and Electronic Components

Click to view similar products for [MOSFET](#) category:

Click to view products by [Will Semiconductor](#) manufacturer:

Other Similar products are found below :

[IRFD120](#) [JANTX2N5237](#) [2SK2267\(Q\)](#) [BUK455-60A/B](#) [TK100A10N1,S4X\(S](#) [MIC4420CM-TR](#) [VN1206L](#) [NDP4060](#) [SI4482DY](#)
[IRS2092STRPBF-EL](#) [IPS70R2K0CEAKMA1](#) [TK31J60W5,S1VQ\(O](#) [TK31J60W,S1VQ\(O](#) [TK16J60W,S1VQ\(O](#) [2SK2614\(TE16L1,Q\)](#)
[DMN1017UCP3-7](#) [EFC2J004NUZTDG](#) [P85W28HP2F-7071](#) [DMN1053UCP4-7](#) [NTE2384](#) [DMC2700UDMQ-7](#) [DMN2080UCB4-7](#)
[DMN61D9UWQ-13](#) [US6M2GTR](#) [DMN31D5UDJ-7](#) [DMP22D4UFO-7B](#) [IPS60R3K4CEAKMA1](#) [DMN1006UCA6-7](#) [DMN16M9UCA6-7](#)
[STF5N65M6](#) [IRF40H233XTMA1](#) [STU5N65M6](#) [DMN6022SSD-13](#) [DMN13M9UCA6-7](#) [DMTH10H4M6SPS-13](#) [IPS60R360PFD7SAKMA1](#)
[DMN2990UFB-7B](#) [SSM3K35CT,L3F](#) [IPLK60R1K0PFD7ATMA1](#) [2N7002W-G](#) [MCAC30N06Y-TP](#) [IPWS65R035CFD7AXKSA1](#)
[MCQ7328-TP](#) [SSM3J143TU,LXHF](#) [DMN12M3UCA6-7](#) [PJMF280N65E1_T0_00201](#) [PJMF380N65E1_T0_00201](#)
[PJMF280N60E1_T0_00201](#) [PJMF600N65E1_T0_00201](#) [PJMF900N65E1_T0_00201](#)