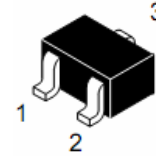
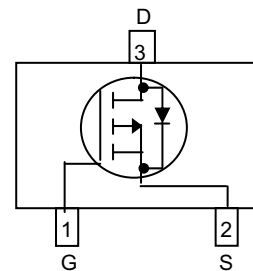
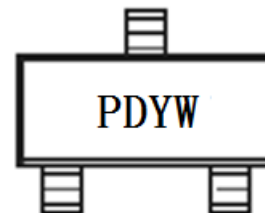

**WPM2080**
**Single P-Channel, -20V, -4.0A, Power MOSFET**
[Http://www.sh-willsemi.com](http://www.sh-willsemi.com)

$V_{DS}$ (V)	Typical $R_{DS(on)}$ (m $\Omega$ )
-20	43 @ $V_{GS}=-4.5V$
	55 @ $V_{GS}=-2.5V$
	81 @ $V_{GS}=-1.8V$

**SOT-23-3L**

**Pin configuration (Top view)**

PD = Device Code  
 Y = Year  
 W = Week(A~z)

**Marking**
**Descriptions**

The WPM2080 is P-Channel enhancement MOS Field Effect Transistor. Uses advanced trench technology and design to provide excellent  $R_{DS(ON)}$  with low gate charge. This device is suitable for use in DC-DC conversion, power switch and charging circuit. Standard Product WPM2080 is Pb-free.

**Features**

- Trench Technology
- Supper high density cell design
- Excellent ON resistance
- Extremely Low Threshold Voltage
- Small package SOT-23-3L

**Applications**

- DC/DC converters
- Power supply converters circuit
- Load/Power Switching for portable device

**Order information**

Device	Package	Shipping
WPM2080-3/TR	SOT-23-3L	3000/Tape&Reel

**Absolute Maximum ratings**

Parameter	Symbol	10 s	Steady State	Unit	
Drain-Source Voltage	$V_{DS}$	-20		V	
Gate-Source Voltage	$V_{GS}$	$\pm 12$			
Continuous Drain Current <sup>a d</sup>	$I_D$	$T_A=25^\circ\text{C}$	-4.0	-3.4	A
		$T_A=70^\circ\text{C}$	-3.2	-2.7	
Maximum Power Dissipation <sup>a d</sup>	$P_D$	$T_A=25^\circ\text{C}$	1.4	1.0	W
		$T_A=70^\circ\text{C}$	0.9	0.6	
Continuous Drain Current <sup>b d</sup>	$I_D$	$T_A=25^\circ\text{C}$	-3.5	-3.2	A
		$T_A=70^\circ\text{C}$	-2.8	-2.6	
Maximum Power Dissipation <sup>b d</sup>	$P_D$	$T_A=25^\circ\text{C}$	1.1	0.9	W
		$T_A=70^\circ\text{C}$	0.7	0.6	
Pulsed Drain Current <sup>c</sup>	$I_{DM}$	-20		A	
Operating Junction Temperature	$T_J$	-55 to 150		$^\circ\text{C}$	
Lead Temperature	$T_L$	260		$^\circ\text{C}$	
Storage Temperature Range	$T_{stg}$	-55 to 150		$^\circ\text{C}$	

**Thermal resistance ratings**

Single Operation					
Parameter		Symbol	Typical	Maximum	Unit
Junction-to-Ambient Thermal Resistance <sup>a</sup>	$t \leq 10 \text{ s}$	$R_{\theta JA}$	70	90	$^\circ\text{C/W}$
	Steady State		90	125	
Junction-to-Ambient Thermal Resistance <sup>b</sup>	$t \leq 10 \text{ s}$	$R_{\theta JA}$	89	115	
	Steady State		115	140	
Junction-to-Case Thermal Resistance	Steady State	$R_{\theta JC}$	40	60	

a Surface mounted on FR4 Board using 1 square inch pad size, 1oz copper

b Surface mounted on FR4 board using minimum pad size, 1oz copper

c Repetitive rating, pulse width limited by junction temperature,  $t_p=10\mu\text{s}$ , Duty Cycle=1%

d Repetitive rating, pulse width limited by junction temperature  $T_J=150^\circ\text{C}$ .

**Electronics Characteristics (Ta=25°C, unless otherwise noted)**

Parameter	Symbol	Test Conditions	Min	Typ	Max	Unit
<b>OFF CHARACTERISTICS</b>						
Drain-to-Source Breakdown Voltage	$BV_{DSS}$	$V_{GS} = 0\text{ V}, I_D = -250\mu\text{A}$	-20			V
Zero Gate Voltage Drain Current	$I_{DSS}$	$V_{DS} = -16\text{ V}, V_{GS} = 0\text{ V}$			-1	$\mu\text{A}$
Gate-to-source Leakage Current	$I_{GSS}$	$V_{DS} = 0\text{ V}, V_{GS} = \pm 12\text{ V}$			$\pm 100$	nA
<b>ON CHARACTERISTICS</b>						
Gate Threshold Voltage	$V_{GS(TH)}$	$V_{GS} = V_{DS}, I_D = -250\mu\text{A}$	-0.35	-0.65	-1	V
Drain-to-source On-resistance	$R_{DS(on)}$	$V_{GS} = -4.5\text{ V}, I_D = -4.0\text{ A}$		43	57	m $\Omega$
		$V_{GS} = -2.5\text{ V}, I_D = -3.0\text{ A}$		55	70	
		$V_{GS} = -1.8\text{ V}, I_D = -2.5\text{ A}$		81	120	
Forward Transconductance	$g_{FS}$	$V_{DS} = -5\text{ V}, I_D = -4\text{ A}$		6	16	S
<b>CHARGES, CAPACITANCES AND GATE RESISTANCE</b>						
Input Capacitance	$C_{ISS}$	$V_{GS} = 0\text{ V}, f = 1.0\text{ MHz}, V_{DS} = -6\text{ V}$		1062		pF
Output Capacitance	$C_{OSS}$			146		
Reverse Transfer Capacitance	$C_{RSS}$			124		
Total Gate Charge	$Q_{G(TOT)}$	$V_{GS} = -4.5\text{ V}, V_{DS} = -10\text{ V}, I_D = -3.3\text{ A}$		10		nC
Threshold Gate Charge	$Q_{G(TH)}$			0.8		
Gate-to-Source Charge	$Q_{GS}$			1.8		
Gate-to-Drain Charge	$Q_{GD}$			1.7		
<b>SWITCHING CHARACTERISTICS</b>						
Turn-On Delay Time	$t_d(ON)$	$V_{GS} = -4.5\text{ V}, V_{DS} = -6\text{ V}, I_D = -3.3\text{ A}, R_G = 6\Omega$		11.4		ns
Rise Time	$t_r$			6.8		
Turn-Off Delay Time	$t_d(OFF)$			67.6		
Fall Time	$t_f$			16.8		
<b>BODY DIODE CHARACTERISTICS</b>						
Forward Voltage	$V_{SD}$	$V_{GS} = 0\text{ V}, I_S = -2.5\text{ A}$		-0.8	-1.5	V

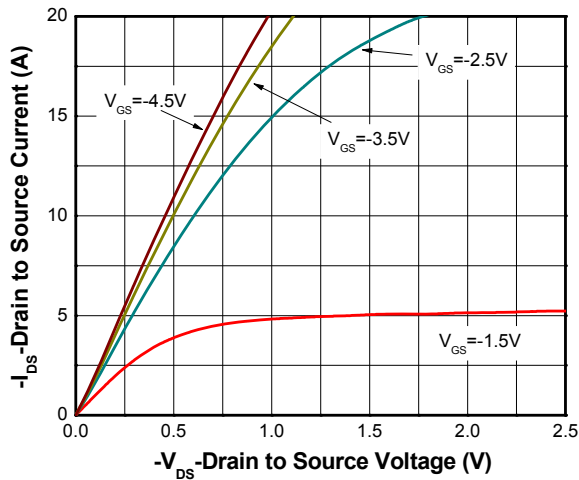
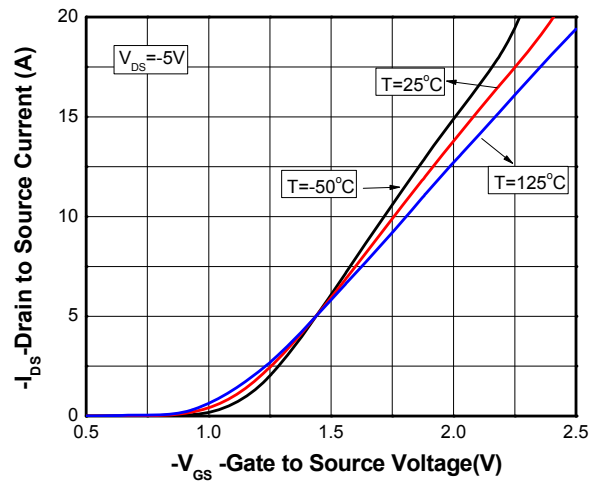
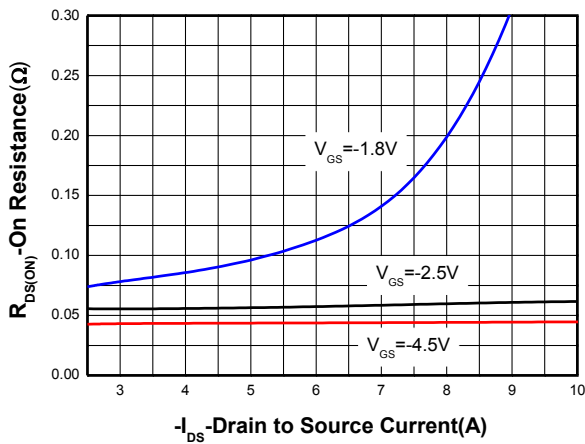
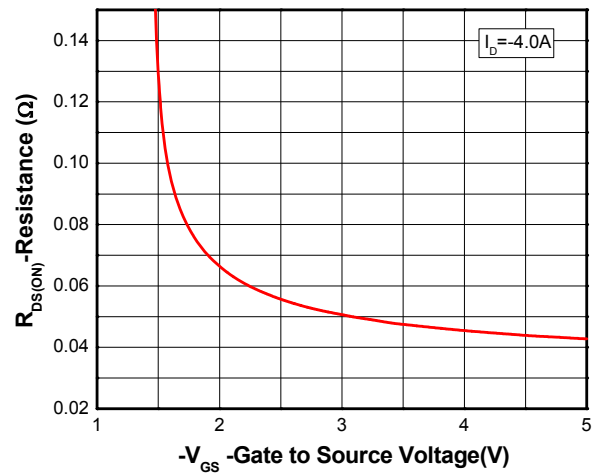
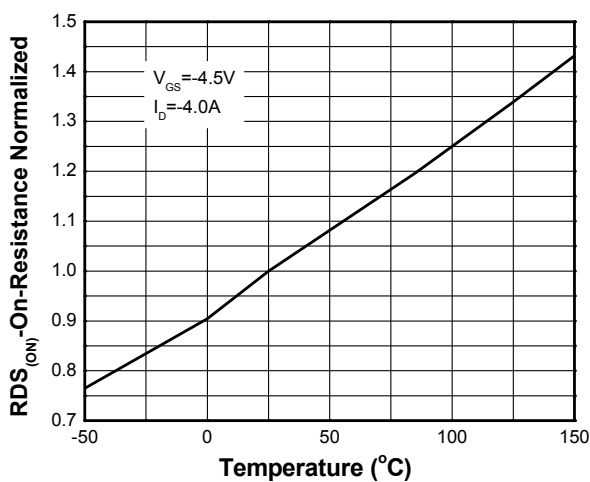
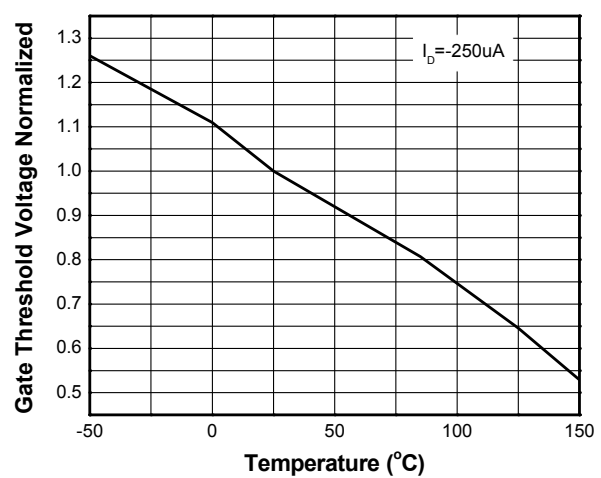
**Typical Characteristics (Ta=25°C, unless otherwise noted)**

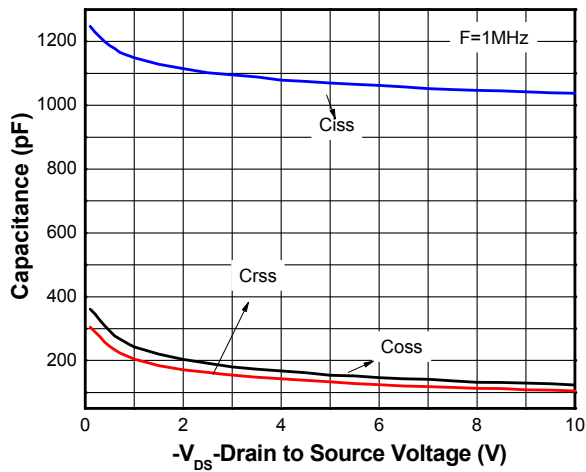
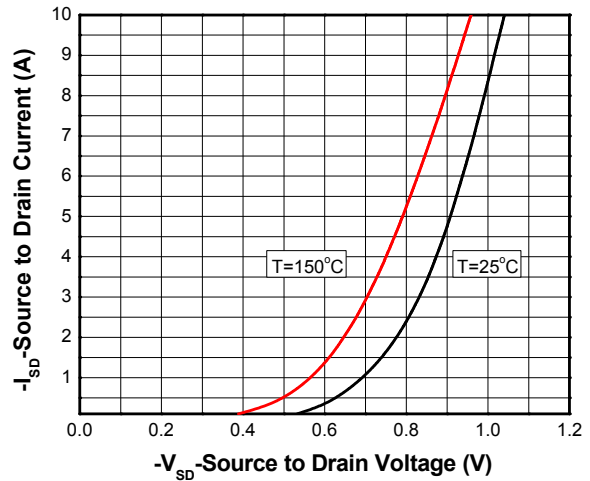
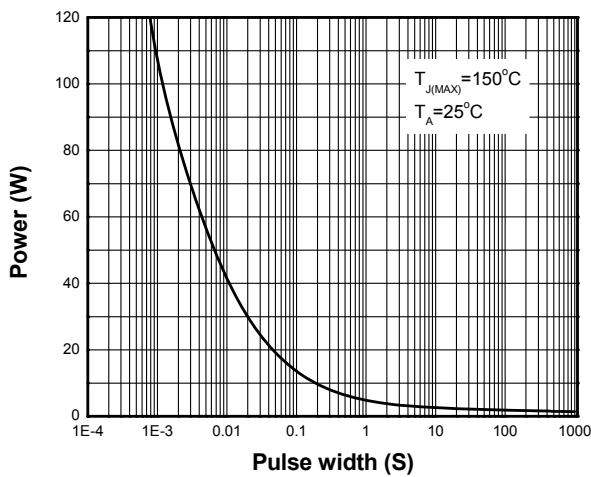
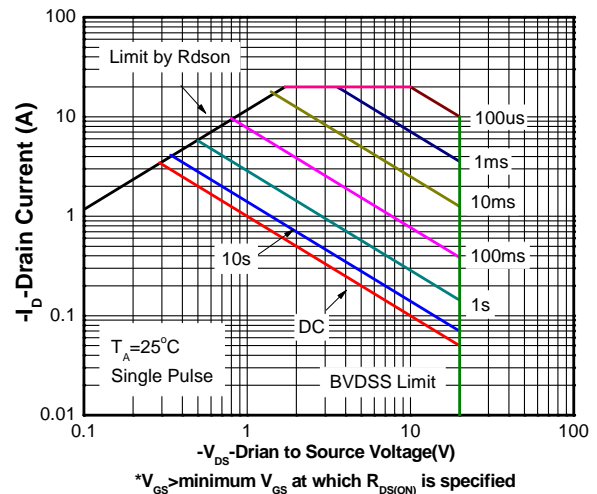
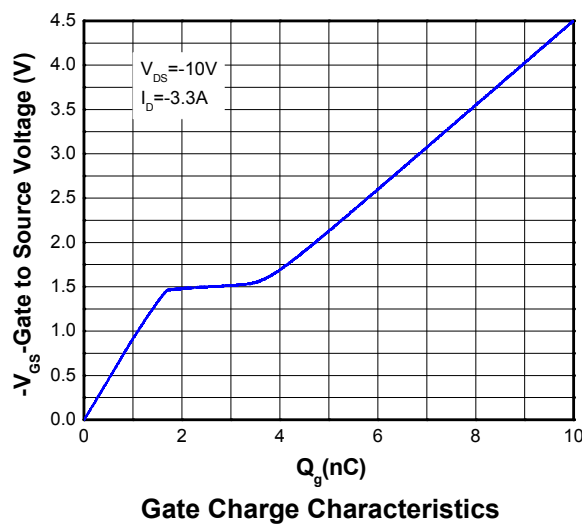
**Output characteristics**

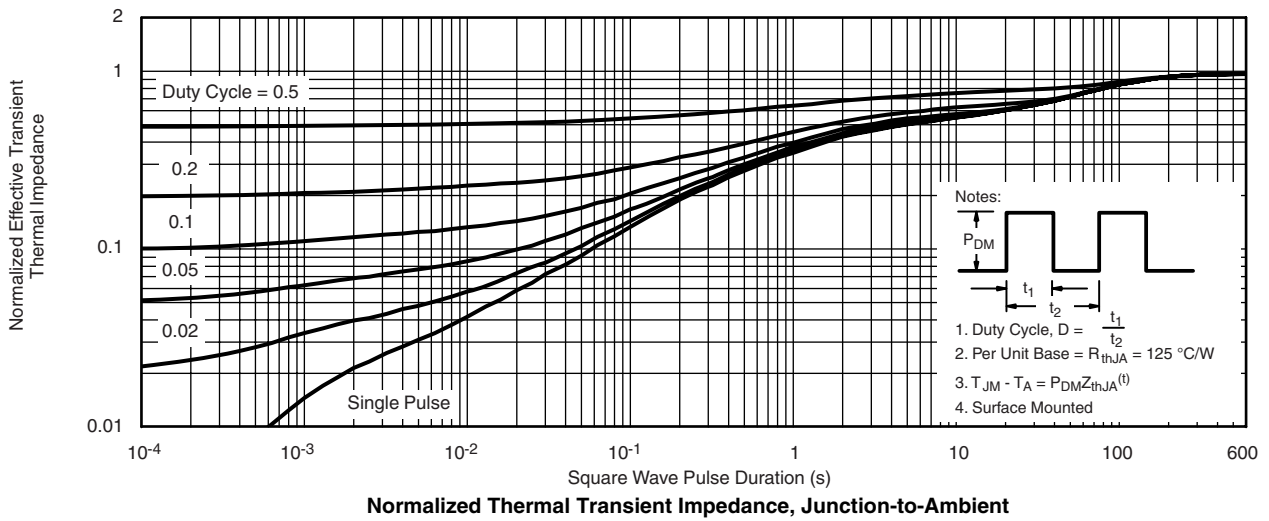
**Transfer characteristics**

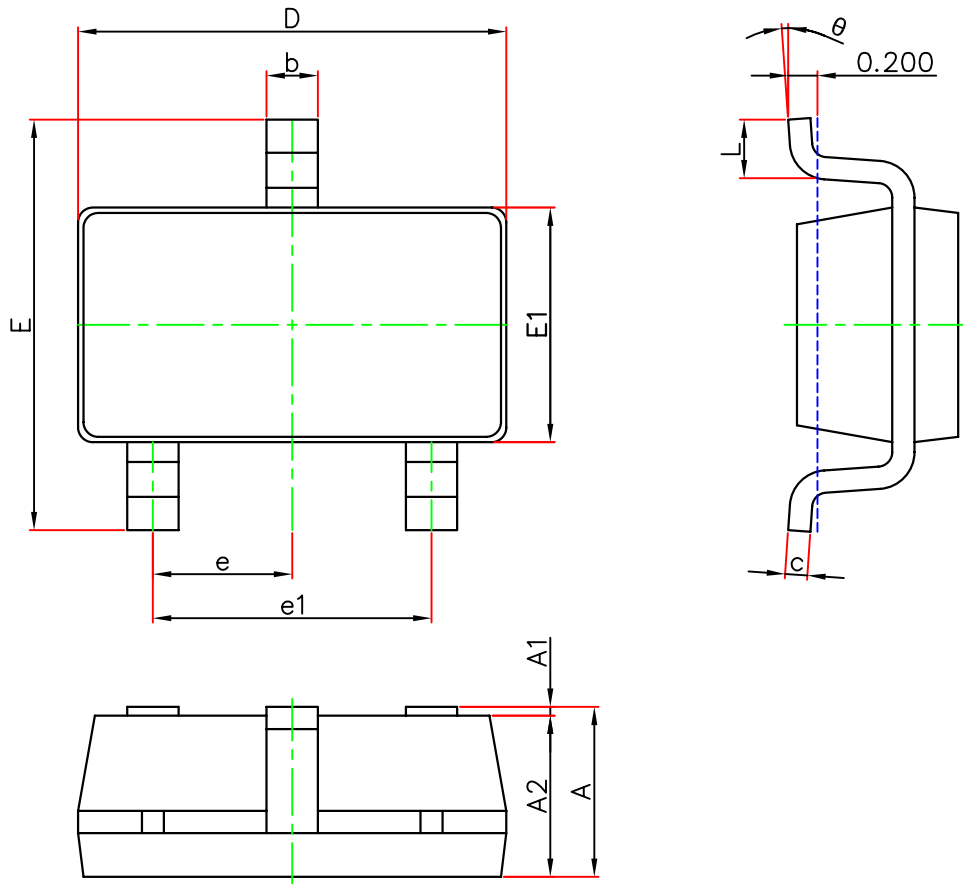
**On-Resistance vs. Drain current**

**On-Resistance vs. Gate-to-source voltage**

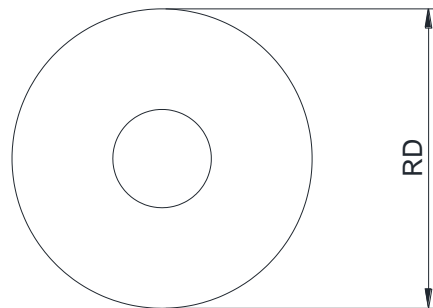
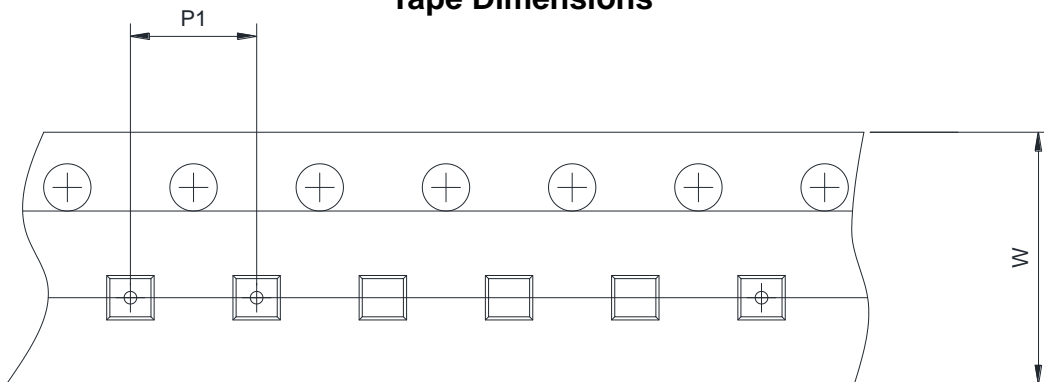
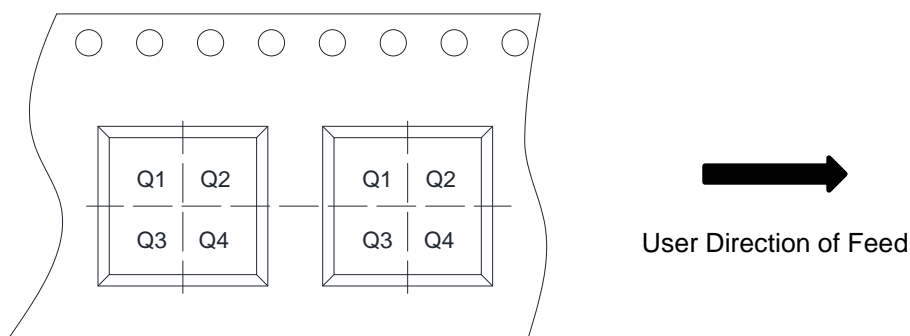
**On-Resistance vs. Junction temperature**

**Threshold voltage vs. Temperature**

**Capacitance**

**Body diode forward voltage**

**Single pulse power**

**Safe operating power**

**Gate Charge Characteristics**

**Transient thermal response (Junction-to-Ambient)**

**Package outline dimensions**
**SOT-23-3L**

Symbol	Dimensions in Millimeters		
	Min.	Typ.	Max.
A	-	-	1.250
A1	0.000	-	0.150
A2	1.000	1.100	1.200
b	0.300	-	0.500
c	0.140	-	0.200
D	2.820	-	3.026
E	2.600	2.800	3.000
E1	1.500	-	1.726
e	0.950 BSC		
e1	1.800	1.900	2.000
L	0.300	0.450	0.600
θ	0 °	-	8 °

**TAPE AND REEL INFORMATION**
**Reel Dimensions**

**Tape Dimensions**

**Quadrant Assignments For PIN1 Orientation In Tape**

RD	Reel Dimension	<input checked="" type="checkbox"/> 7inch	<input type="checkbox"/> 13inch
W	Overall width of the carrier tape	<input checked="" type="checkbox"/> 8mm	<input type="checkbox"/> 12mm <input type="checkbox"/> 16mm
P1	Pitch between successive cavity centers	<input type="checkbox"/> 2mm	<input checked="" type="checkbox"/> 4mm <input type="checkbox"/> 8mm
Pin1	Pin1 Quadrant	<input type="checkbox"/> Q1	<input type="checkbox"/> Q2 <input checked="" type="checkbox"/> Q3 <input type="checkbox"/> Q4



## X-ON Electronics

Largest Supplier of Electrical and Electronic Components

*Click to view similar products for [MOSFET](#) category:*

*Click to view products by [Will Semiconductor](#) manufacturer:*

Other Similar products are found below :

[IRFD120](#) [JANTX2N5237](#) [2SK2267\(Q\)](#) [BUK455-60A/B](#) [TK100A10N1,S4X\(S](#) [MIC4420CM-TR](#) [VN1206L](#) [NDP4060](#) [SI4482DY](#)  
[IRS2092STRPBF-EL](#) [IPS70R2K0CEAKMA1](#) [SQM120N06-3M5L-GE3](#) [TK31J60W5,S1VQ\(O](#) [TK31J60W,S1VQ\(O](#) [TK16J60W,S1VQ\(O](#)  
[2SK2614\(TE16L1,Q\)](#) [DMN1017UCP3-7](#) [EFC2J004NUZTDG](#) [P85W28HP2F-7071](#) [NTE2384](#) [DMC2700UDMQ-7](#) [DMN2080UCB4-7](#)  
[DMN61D9UWQ-13](#) [US6M2GTR](#) [DMN31D5UDJ-7](#) [DMP22D4UFO-7B](#) [IPS60R3K4CEAKMA1](#) [DMN1006UCA6-7](#) [DMN16M9UCA6-7](#)  
[STF5N65M6](#) [IRF40H233XTMA1](#) [STU5N65M6](#) [DMN6022SSD-13](#) [DMN13M9UCA6-7](#) [DMTH10H4M6SPS-13](#) [IPS60R360PFD7SAKMA1](#)  
[DMN2990UFB-7B](#) [SSM3K35CT,L3F](#) [IPLK60R1K0PFD7ATMA1](#) [2N7002W-G](#) [MCAC30N06Y-TP](#) [IPWS65R035CFD7AXKSA1](#)  
[MCQ7328-TP](#) [SSM3J143TU,LXHF](#) [PJMF280N65E1\\_T0\\_00201](#) [PJMF380N65E1\\_T0\\_00201](#) [PJMF280N60E1\\_T0\\_00201](#)  
[PJMF600N65E1\\_T0\\_00201](#) [PJMF900N65E1\\_T0\\_00201](#) [PJMF900N60E1\\_T0\\_00201](#)