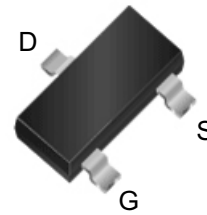
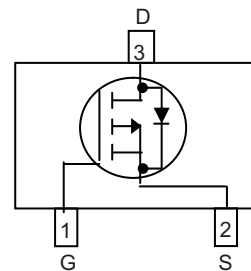

WPM2081
Single P-Channel, -20V, -3.2A, Power MOSFET
[Http://www.sh-willsemi.com](http://www.sh-willsemi.com)

V_{DS} (V)	Typical $R_{DS(on)}$ (m Ω)
-20	43 @ $V_{GS}=-4.5V$
	55 @ $V_{GS}=-2.5V$

SOT-23

Pin configuration (Top view)
Descriptions

The WPM2081 is P-Channel enhancement MOS Field Effect Transistor. Uses advanced trench technology and design to provide excellent $R_{DS(ON)}$ with low gate charge. This device is suitable for use in DC-DC conversion, power switch and charging circuit. Standard Product WPM2081 is Pb-free.

Features

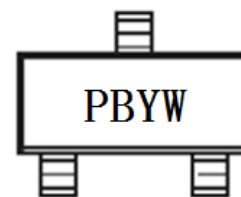
- Trench Technology
- Supper high density cell design
- Excellent ON resistance
- Extremely Low Threshold Voltage
- Small package SOT-23



PB = Device Code
 Y = Year
 W = Week(A~z)

Marking
Applications

- DC/DC converters
- Power supply converters circuit
- Load/Power Switching for portable device

Order information

Device	Package	Shipping
WPM2081-3/TR	SOT-23	3000/Tape&Reel

Absolute Maximum ratings

Parameter	Symbol	10 s	Steady State	Unit	
Drain-Source Voltage	V_{DS}	-20		V	
Gate-Source Voltage	V_{GS}	±12			
Continuous Drain Current ^{a d}	I_D	$T_A=25^{\circ}C$	-3.2	-2.9	A
		$T_A=70^{\circ}C$	-2.6	-2.3	
Maximum Power Dissipation ^{a d}	P_D	$T_A=25^{\circ}C$	0.96	0.80	W
		$T_A=70^{\circ}C$	0.62	0.52	
Continuous Drain Current ^{b d}	I_D	$T_A=25^{\circ}C$	-2.9	-2.6	A
		$T_A=70^{\circ}C$	-2.3	-2.1	
Maximum Power Dissipation ^{b d}	P_D	$T_A=25^{\circ}C$	0.78	0.66	W
		$T_A=70^{\circ}C$	0.50	0.42	
Pulsed Drain Current ^c	I_{DM}	-12		A	
Operating Junction Temperature	T_J	-55 to 150		°C	
Lead Temperature	T_L	260		°C	
Storage Temperature Range	T_{stg}	-55 to 150		°C	

Thermal resistance ratings

Single Operation					
Parameter	Symbol	Typical	Maximum	Unit	
Junction-to-Ambient Thermal Resistance ^a	$R_{\theta JA}$	$t \leq 10$ s	105	130	°C/W
		Steady State	120	155	
Junction-to-Ambient Thermal Resistance ^b	$R_{\theta JA}$	$t \leq 10$ s	130	160	
		Steady State	145	190	
Junction-to-Case Thermal Resistance	$R_{\theta JC}$	40	60		

a Surface mounted on FR4 Board using 1 square inch pad size, 1oz copper

b Surface mounted on FR4 board using minimum pad size, 1oz copper

c Repetitive rating, pulse width limited by junction temperature, $t_p=10\mu s$, Duty Cycle=1%

d Repetitive rating, pulse width limited by junction temperature $T_J=150^{\circ}C$.

Electronics Characteristics (Ta=25°C, unless otherwise noted)

Parameter	Symbol	Test Conditions	Min	Typ	Max	Unit
OFF CHARACTERISTICS						
Drain-to-Source Breakdown Voltage	BV_{DSS}	$V_{GS} = 0\text{ V}, I_D = -250\mu\text{A}$	-20			V
Zero Gate Voltage Drain Current	I_{DSS}	$V_{DS} = -16\text{ V}, V_{GS} = 0\text{ V}$			-1	μA
Gate-to-source Leakage Current	I_{GSS}	$V_{DS} = 0\text{ V}, V_{GS} = \pm 12\text{ V}$			± 100	nA
ON CHARACTERISTICS						
Gate Threshold Voltage	$V_{GS(TH)}$	$V_{GS} = V_{DS}, I_D = -250\mu\text{A}$	-0.35	-0.65	-1	V
Drain-to-source On-resistance	$R_{DS(on)}$	$V_{GS} = -4.5\text{ V}, I_D = -3.2\text{ A}$		43	65	m Ω
		$V_{GS} = -2.5\text{ V}, I_D = -3.0\text{ A}$		55	81	
		$V_{GS} = -1.8\text{ V}, I_D = -2.5\text{ A}$		72	110	
Forward Transconductance	g_{FS}	$V_{DS} = -5\text{ V}, I_D = -4\text{ A}$		6	16	S
CHARGES, CAPACITANCES AND GATE RESISTANCE						
Input Capacitance	C_{ISS}	$V_{GS} = 0\text{ V}, f = 1.0\text{ MHz}, V_{DS} = -6\text{ V}$		1062		pF
Output Capacitance	C_{OSS}			146		
Reverse Transfer Capacitance	C_{RSS}			124		
Total Gate Charge	$Q_{G(TOT)}$	$V_{GS} = -4.5\text{ V}, V_{DS} = -10\text{ V}, I_D = -3.3\text{ A}$		10		nC
Threshold Gate Charge	$Q_{G(TH)}$			0.8		
Gate-to-Source Charge	Q_{GS}			1.8		
Gate-to-Drain Charge	Q_{GD}			1.7		
SWITCHING CHARACTERISTICS						
Turn-On Delay Time	$t_d(ON)$	$V_{GS} = -4.5\text{ V}, V_{DS} = -6\text{ V}, I_D = -3.3\text{ A}, R_G = 6\Omega$		11.4		ns
Rise Time	t_r			6.8		
Turn-Off Delay Time	$t_d(OFF)$			67.6		
Fall Time	t_f			16.8		
BODY DIODE CHARACTERISTICS						
Forward Voltage	V_{SD}	$V_{GS} = 0\text{ V}, I_S = -3.2\text{ A}$		-0.8	-1.5	V

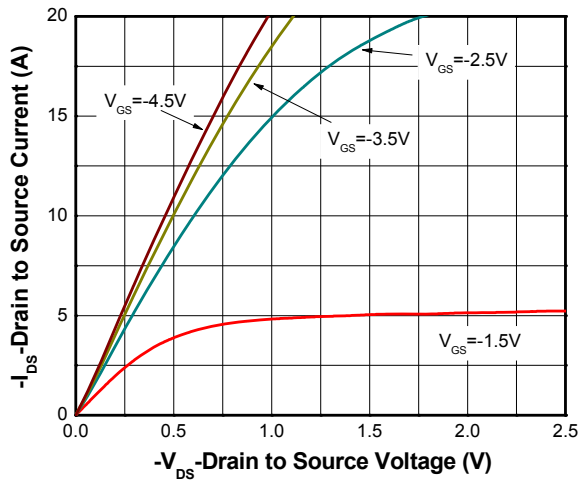
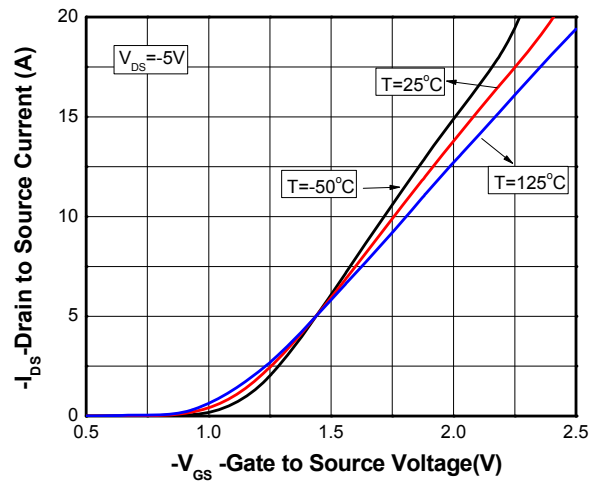
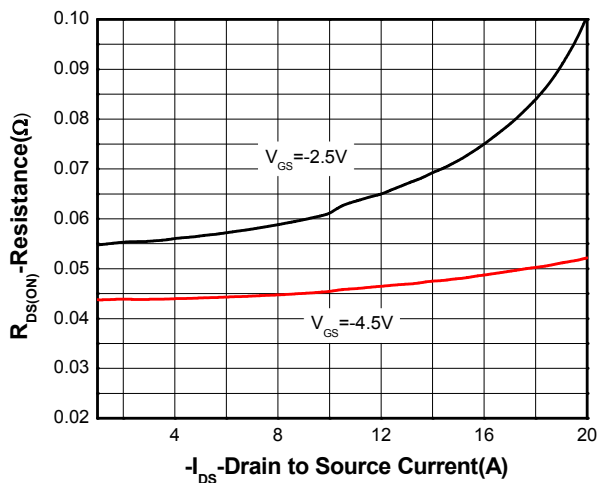
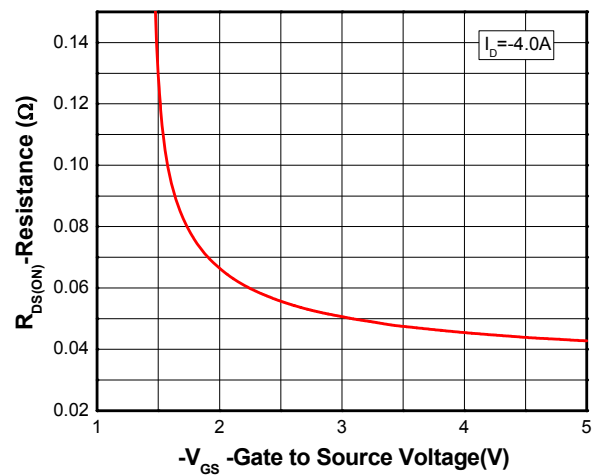
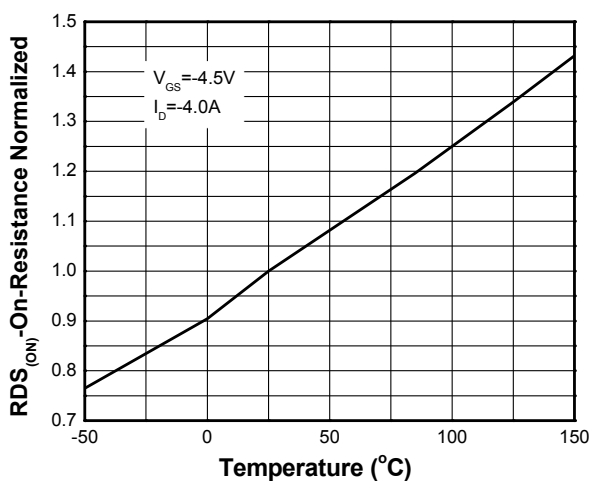
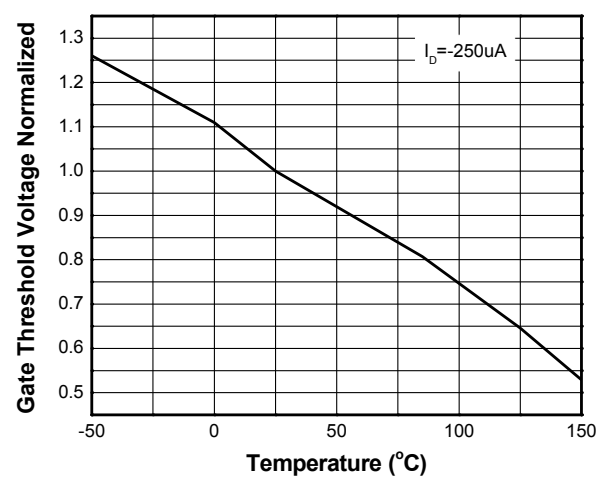
Typical Characteristics (Ta=25°C, unless otherwise noted)

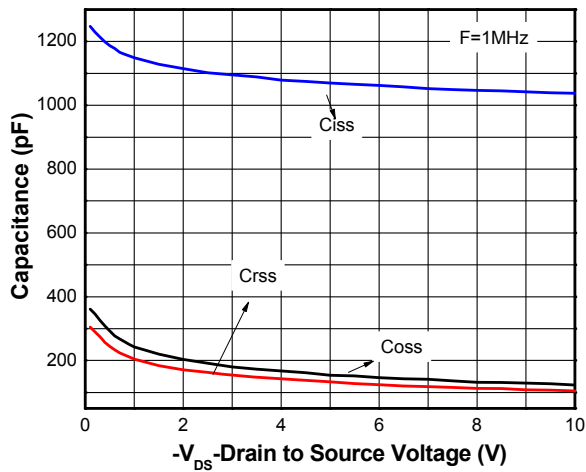
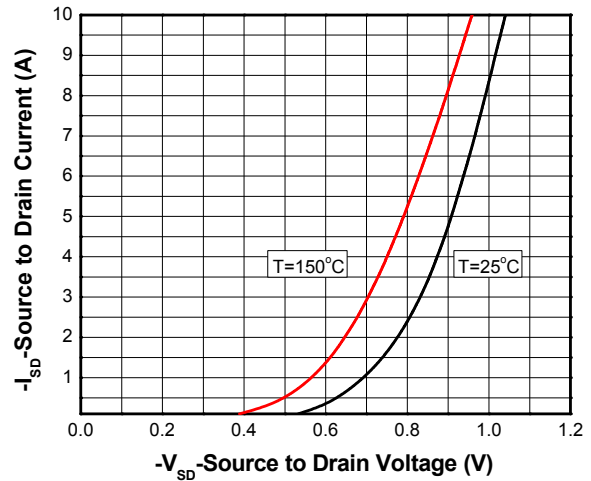
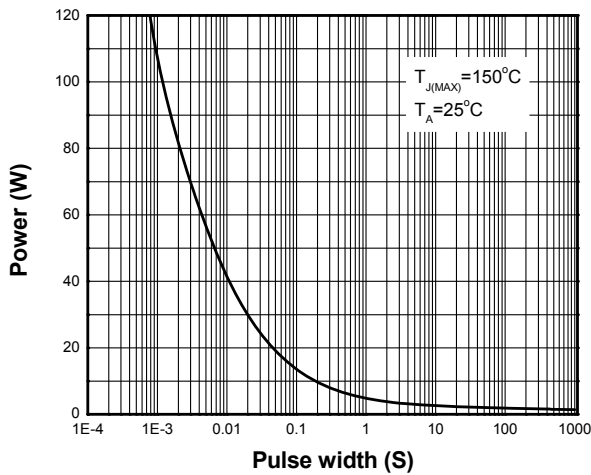
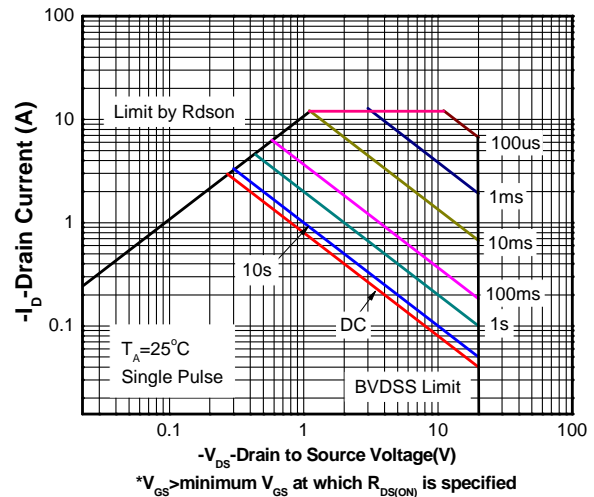
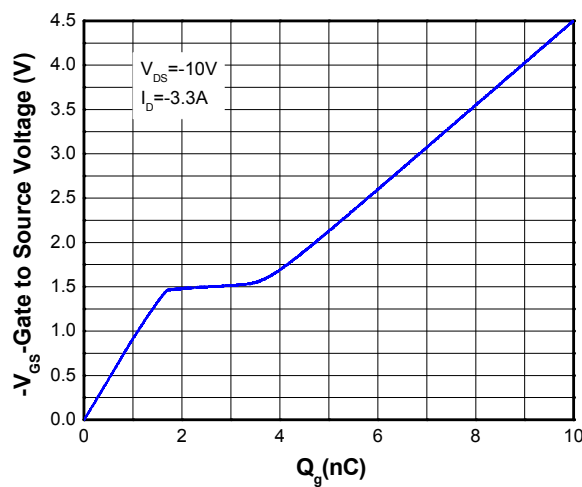
Output characteristics

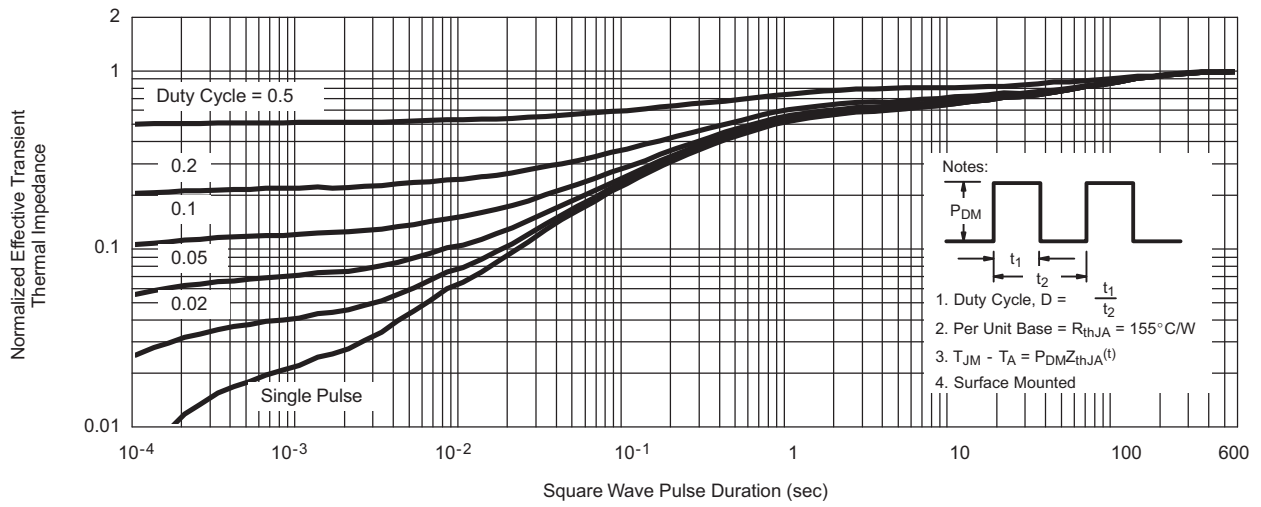
Transfer characteristics

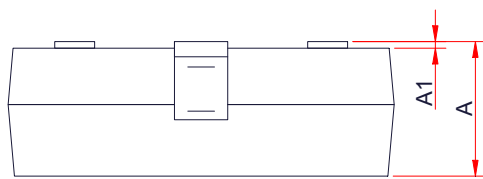
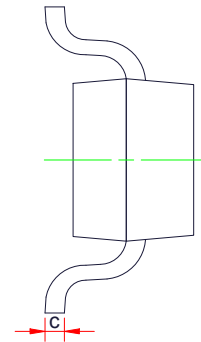
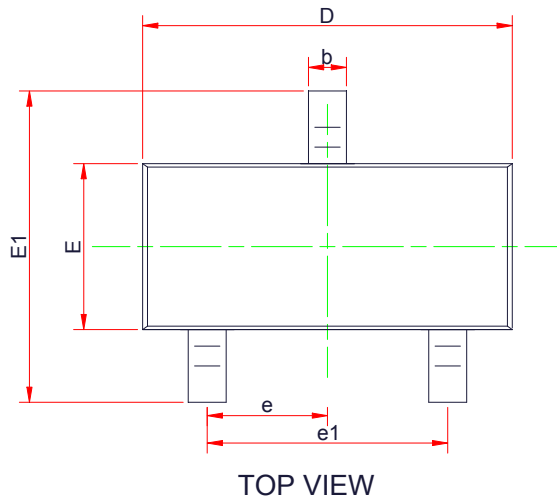
On-Resistance vs. Drain current

On-Resistance vs. Gate-to-source voltage

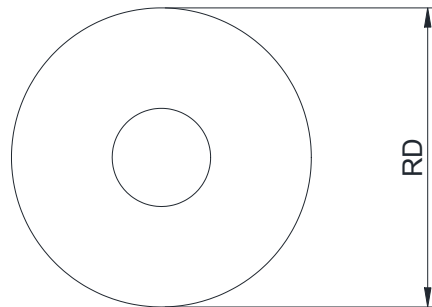
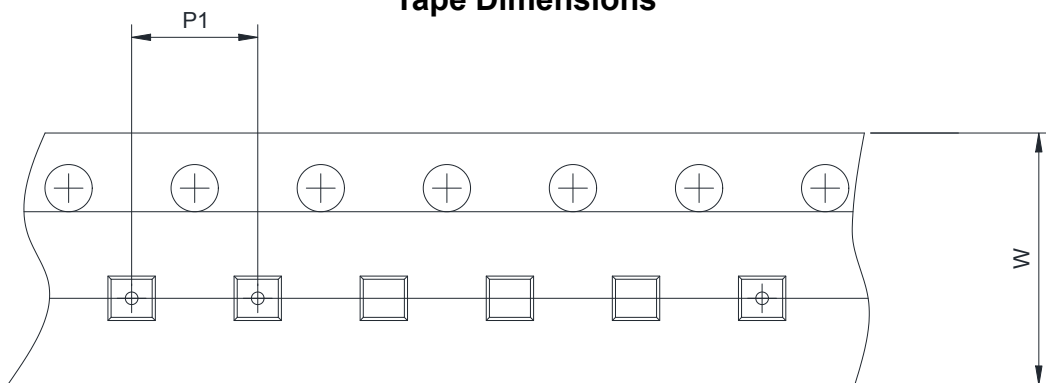
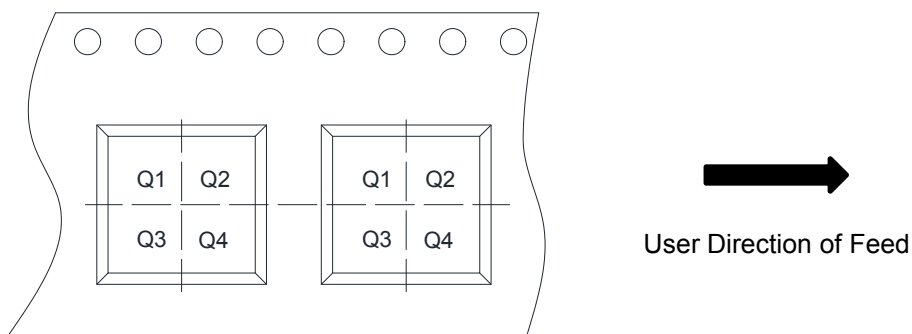
On-Resistance vs. Junction temperature

Threshold voltage vs. Temperature

Capacitance

Body diode forward voltage

Single pulse power

Safe operating power

Gate Charge Characteristics

Transient thermal response (Junction-to-Ambient)

Package outline dimensions
SOT-23

SIDE VIEW

Symbol	Dimensions in Millimeters		
	Min.	Typ.	Max.
A	0.89	1.10	1.30
A1	0.00	-	0.10
b	0.30	0.43	0.55
c	0.05	-	0.20
D	2.70	2.90	3.10
E	1.15	1.33	1.50
E1	2.10	2.40	2.70
e	0.95 Typ.		
e1	1.70	1.90	2.10

TAPE AND REEL INFORMATION
Reel Dimensions

Tape Dimensions

Quadrant Assignments For PIN1 Orientation In Tape

RD	Reel Dimension	<input checked="" type="checkbox"/> 7inch	<input type="checkbox"/> 13inch
W	Overall width of the carrier tape	<input checked="" type="checkbox"/> 8mm	<input type="checkbox"/> 12mm <input type="checkbox"/> 16mm
P1	Pitch between successive cavity centers	<input type="checkbox"/> 2mm	<input checked="" type="checkbox"/> 4mm <input type="checkbox"/> 8mm
Pin1	Pin1 Quadrant	<input type="checkbox"/> Q1	<input type="checkbox"/> Q2 <input checked="" type="checkbox"/> Q3 <input type="checkbox"/> Q4

X-ON Electronics

Largest Supplier of Electrical and Electronic Components

Click to view similar products for [MOSFET](#) category:

Click to view products by [Will Semiconductor](#) manufacturer:

Other Similar products are found below :

[614233C](#) [648584F](#) [MCH3443-TL-E](#) [MCH6422-TL-E](#) [FDPF9N50NZ](#) [FW216A-TL-2W](#) [FW231A-TL-E](#) [APT5010JVR](#) [NTNS3A92PZT5G](#)
[IRF100S201](#) [JANTX2N5237](#) [2SK2464-TL-E](#) [2SK3818-DL-E](#) [FCA20N60_F109](#) [FDZ595PZ](#) [STD6600NT4G](#) [FSS804-TL-E](#) [2SJ277-DL-E](#)
[2SK1691-DL-E](#) [2SK2545\(Q,T\)](#) [D2294UK](#) [405094E](#) [423220D](#) [MCH6646-TL-E](#) [TPCC8103,L1Q\(CM](#) [367-8430-0972-503](#) [VN1206L](#)
[424134F](#) [026935X](#) [051075F](#) [SBVS138LT1G](#) [614234A](#) [715780A](#) [NTNS3166NZT5G](#) [751625C](#) [873612G](#) [IRF7380TRHR](#)
[IPS70R2K0CEAKMA1](#) [RJK60S3DPP-E0#T2](#) [RJK60S5DPK-M0#T0](#) [APT5010JVFR](#) [APT12031JFLL](#) [APT12040JVR](#) [DMN3404LQ-7](#)
[NTE6400](#) [JANTX2N6796U](#) [JANTX2N6784U](#) [JANTXV2N5416U4](#) [SQM110N05-06L-GE3](#) [SIHF35N60E-GE3](#)