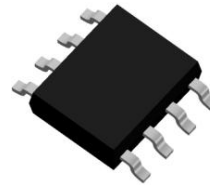
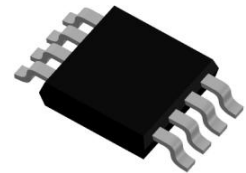
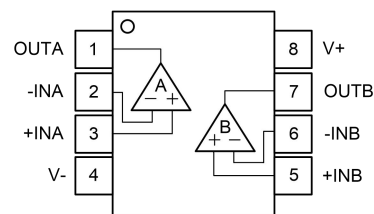

WS72142
300nA Nano-Power Rail-to-Rail Input Output Operational Amplifiers
[Http://www.willsemi.com](http://www.willsemi.com)
Descriptions

The WS72142 is a dual low-voltage operational amplifier with rail-to-rail input/output swing. Ultra low power makes this amplifier ideal for battery-powered and portable applications. The WS72142 has a gain-bandwidth product of 13kHz (TYP) and is unity gain stable. These specifications make this operational amplifier appropriate for low frequency applications, such as battery current monitoring and sensor conditioning.

WS72142 is available with MSL 3 Level in SOP-8L package and MSOP-8L package. Standard products are Pb-Free and halogen-Free.

SOP-8L

MSOP-8L

SOP-8L/MSOP-8L
Pin configuration (Top view)
Applications

- Handsets and Mobile Accessories
- Current Sensing
- Wireless Remote Sensors, Active RFID Readers
- Environment/Gas/Oxygen Sensors
- Threshold Detectors/Discriminators
- Low Power Filters
- Battery or Solar Powered Devices
- Sensor Network Powered by Energy Scavenging

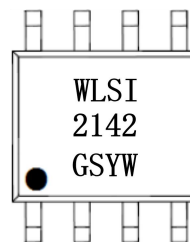
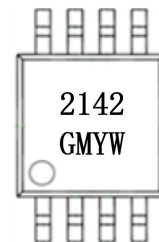
Features

- Wide Supply Voltage : 1.6~5.5V
- Quiescent Current per Amplifier : 300nA Typical
- GBWP : 13kHz
- Rail-to-Rail Input/Output Swing
- Unity Gain Stable
- -40°C to 125°C Operation Temperature Range
- Available in Green SOP-8L and MSOP-8L Packages

SOP-8L

MSOP-8L
Marking

- 2142** = Device code
- GS** = Special code
- GM** = Special code
- Y** = Year code
- W** = Week code

Order Information

Device	Package	Shipping
WS72142S-8/TR	SOP-8L	4000/Reel & Tape
WS72142M-8/TR	MSOP-8L	4000/Reel & Tape

Pin Descriptions

Pin Number	Symbol	Descriptions
1	OUTA	Output
2	-INA	Inverting input
3	+INA	Non-inverting input
4	V-	Negative supply
5	+INB	Non-inverting input
6	-INB	Inverting input
7	OUTB	Output
8	V+	Positive supply

Absolute Maximum Ratings⁽¹⁾

Parameter	Symbol	Value	Unit
Supply Voltage, ([V+] - [V-])	$V_S^{(2)}$	6	V
Input Common Mode Voltage Range	V_{ICR}	(V ⁻)-0.3 to (V ⁺)+0.3	V
Output Short-Circuit Duration	$t_{SO}^{(3)}$	Unlimited	/
Operating Free-Air Temperature Range	T_A	-40 to 125	°C
Storage Temperature Range	T_{STG}	-65 to 150	°C
Junction Temperature Range	T_J	150	°C
Lead Temperature Range	T_L	260	°C

Note:

- Stresses beyond those listed under Absolute Maximum Ratings may cause permanent damage to the device. These are only stress ratings, and functional operation of the device at these or any other conditions beyond those indicated under recommended operating conditions are not implied. Exposure to absolute-maximum-rated conditions for extended periods may affect device reliability.
- All voltage values, except differential voltage are with respect to network terminal.
- A heat sink may be required to keep the junction temperature below the absolute maximum, depends on the power supply voltage and how many amplifiers are shorted. Thermal resistance varies the amount of PC board metal connected to the package. The specified values are for short traces connected to leads.

ESD, Electrostatic Discharge Protection

Symbol	Parameter	Condition	Minimum level	Unit
HBM	Human Body Model ESD	MIL-STD-883H Method 3015.8 JEDEC-EIA/JESD22-A114A	±8000	V
CDM	Charged Device Model ESD	JEDEC-EIA/JESD22-C101E	±2000	V
MM	Machine Model ESD	JEDEC-EIA/JESD22-A115	±400	V

Electronics Characteristics

The *denotes the specifications which apply over the full operating temperature range, otherwise specifications are at $T_A = 27^\circ\text{C}$. $V_S = 5\text{V}$, $V_{\text{CM}} = V_{\text{OUT}} = V_S/2$, $R_{\text{load}} = 100\text{k}\Omega$, $C_{\text{load}} = 60\text{pF}$.

Symbol	Parameter		Conditions	Min.	Typ.	Max.	Unit
V_{OS}	Input Offset Voltage		$V_{\text{CM}} = V_S/2$ and $V_{\text{CM}} = \text{GND}$ *	-3.5	± 0.1	3.5	mV
α_{VOS}	Input Offset Voltage Drift				1.6		$\mu\text{V}/^\circ\text{C}$
I_{IB}	Input Bias Current				<10		pA
I_{OS}	Input Offset Current				<10		pA
V_n	Input Voltage Noise		$f = 0.1\text{Hz to } 10\text{Hz}$		8		$\mu\text{V}_{\text{P-P}}$
e_n	Input Voltage Noise Density		$f = 1\text{kHz}$		80		$\text{nV}/\sqrt{\text{Hz}}$
R_{IN}	Input Resistance				>1		T Ω
CMRR	Common Mode Rejection Ratio		$V_{\text{CM}} = 0.1\text{V to } 4.9\text{V}$ *	55	75		dB
V_{CM}	Common Mode Input Voltage Range			$(V^-) - 0.3$		$(V^+) + 0.3$	V
PSRR	Power Supply Rejection Ratio			65	91		dB
A_{VOL}	Open Loop Large Signal Gain		$V_{\text{OUT}} = 2.5\text{V}, R_{\text{load}} = 100\text{k}\Omega$		118		dB
			$V_{\text{OUT}} = 0.1\text{V to } 4.9\text{V}, R_{\text{load}} = 100\text{k}\Omega$ *	85	118		dB
$V_{\text{OL}}, V_{\text{OH}}$	Output Swing from Supply Rail		$R_{\text{load}} = 100\text{k}\Omega$		5		mV
R_{OUT}	Closed-Loop Output Impedance		$G = 1, f = 1\text{kHz}, I_{\text{OUT}} = 0$		4.3		Ω
I_{SC}	Output Short-Circuit Current		Sink or Source Current	12	15		mA
V_{DD}	Supply Voltage			1.6		5.5	V
I_{Q}	Quiescent Current per Amplifier				300	450	nA
PM	Phase Margin		$R_{\text{load}} = 100\text{k}\Omega, C_{\text{load}} = 60\text{pF}$		80		degrees
GM	Gain Margin		$R_{\text{load}} = 100\text{k}\Omega, C_{\text{load}} = 60\text{pF}$		18		dB
GBWP	Gain-Bandwidth Product		$f = 1\text{kHz}$		13		kHz
t_s	Settling Time	1.5 to 3.5V, Unity Gain	0.1%		0.4		ms
		2.45 to 2.55V, Unity Gain	0.1%		0.04		
SR	Slew Rate		$A_V = 1, V_{\text{OUT}} = 1.5\text{V to } 3.5\text{V}, R_{\text{load}} = 100\text{k}\Omega, C_{\text{load}} = 60\text{pF}$		7		$\text{mV}/\mu\text{s}$
FPBW	Full Power Bandwidth ^{Note1}		$2V_{\text{P-P}}$		300		Hz

Note:

1. Full power bandwidth is calculated from the slew rate $\text{FPBW} = \text{SR}/(\pi \cdot V_{\text{P-P}})$.

Typical Characteristics
 $T_A=25^\circ\text{C}$, $V_S=5\text{V}$, $V_{\text{CM}}=V_S/2$, unless otherwise noted

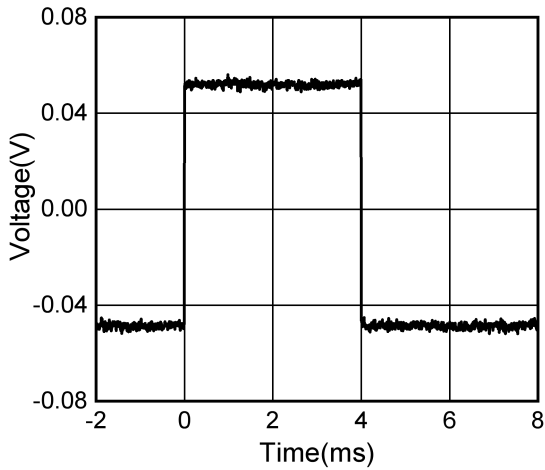
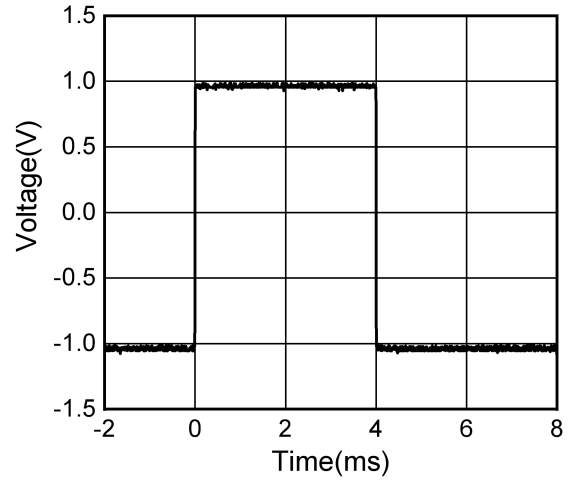
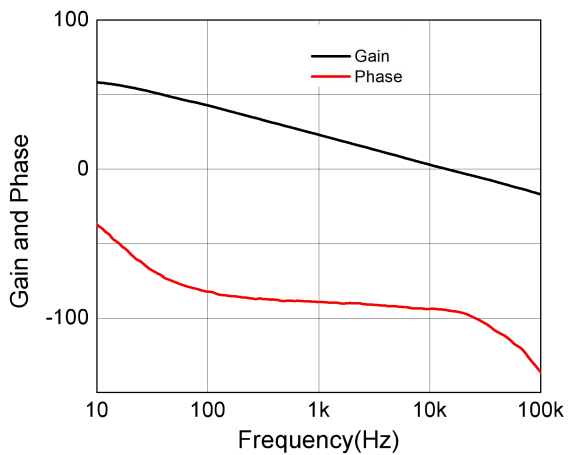
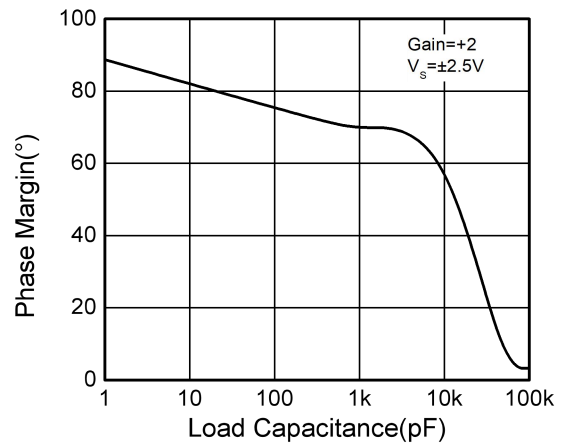
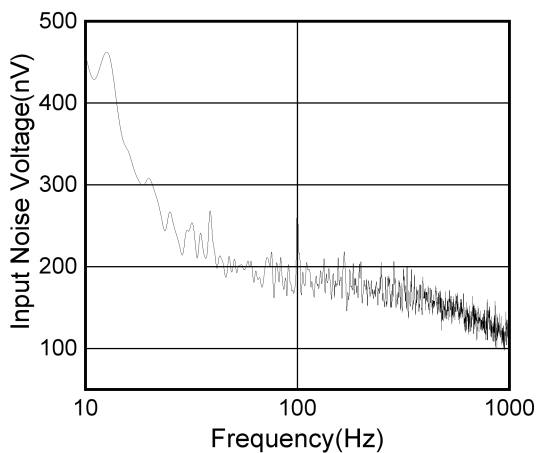
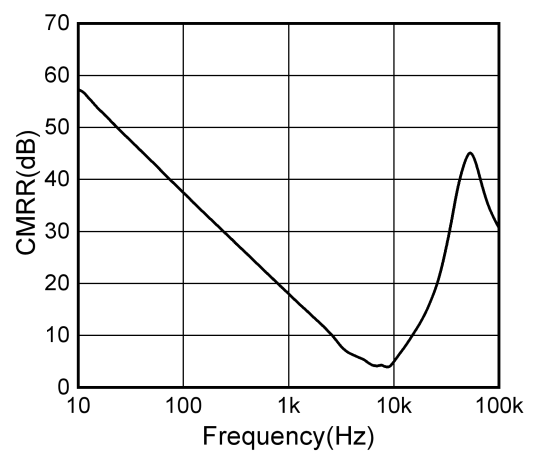
Small-Signal Step Response, 100mV Step

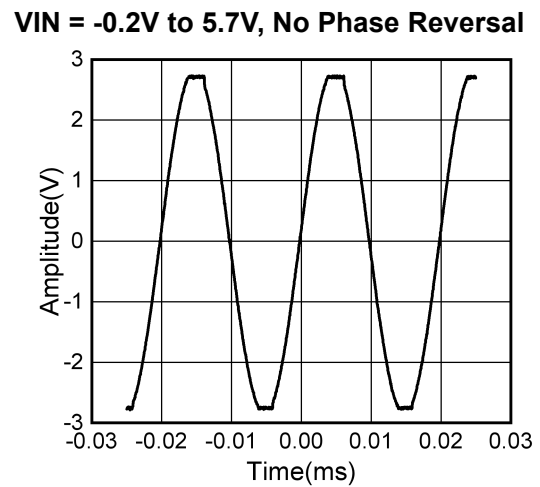
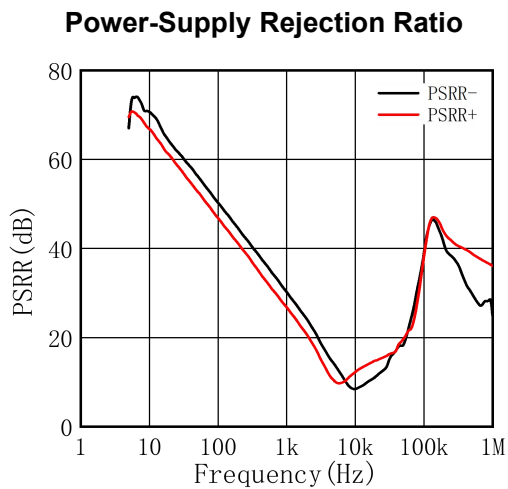
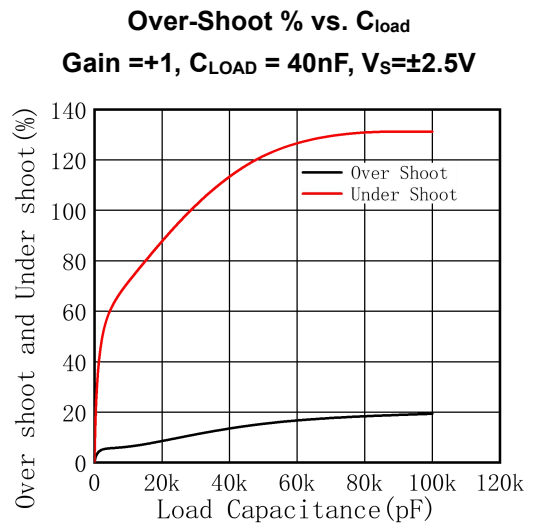
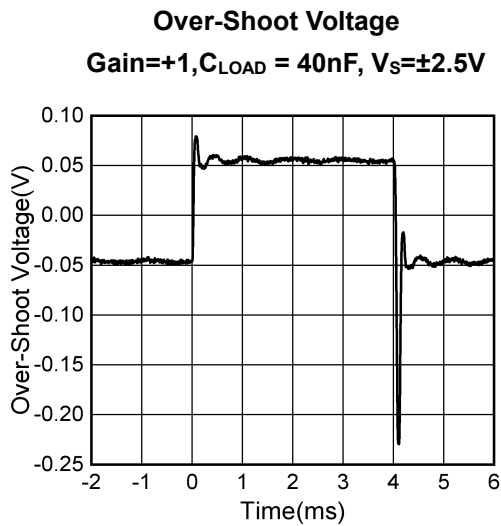
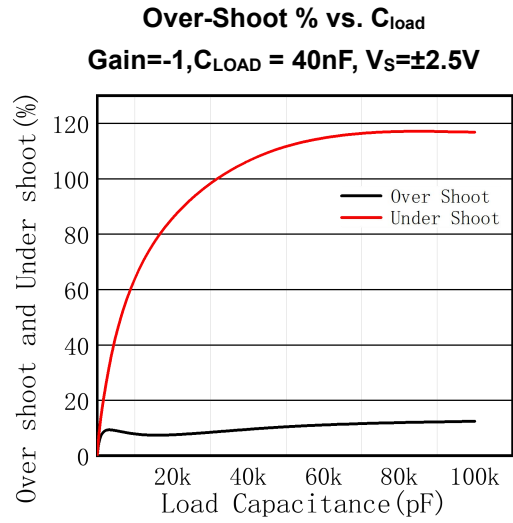
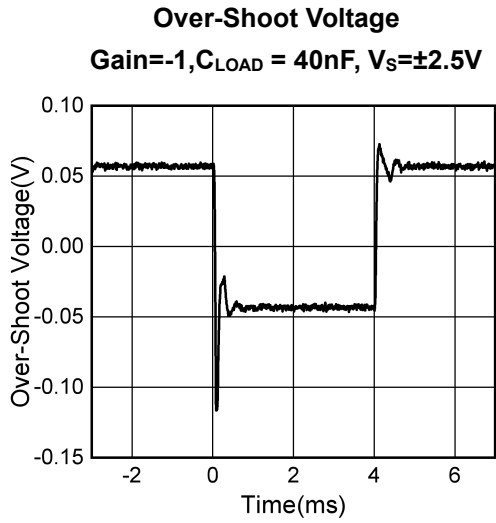
Large-Signal Step Response, 2V Step

Open-Loop Gain and Phase

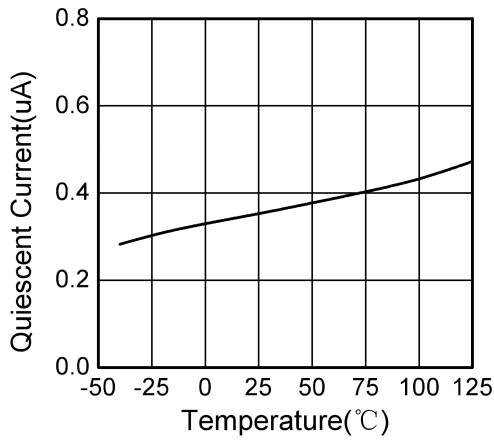
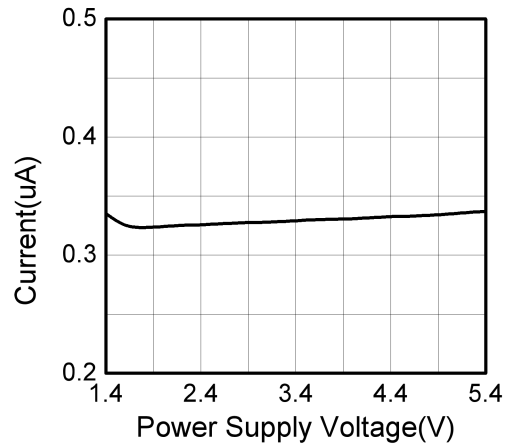
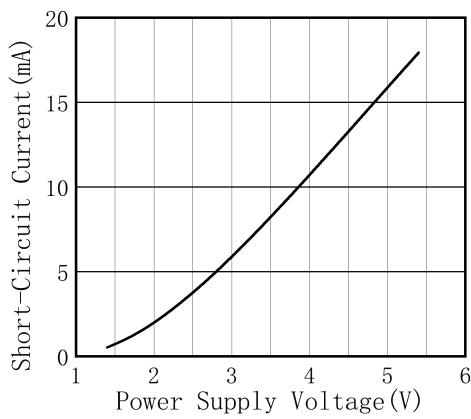
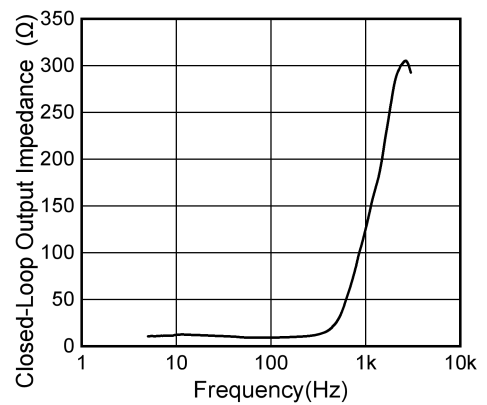
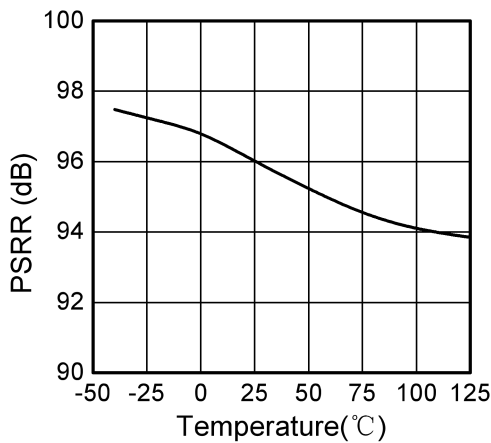
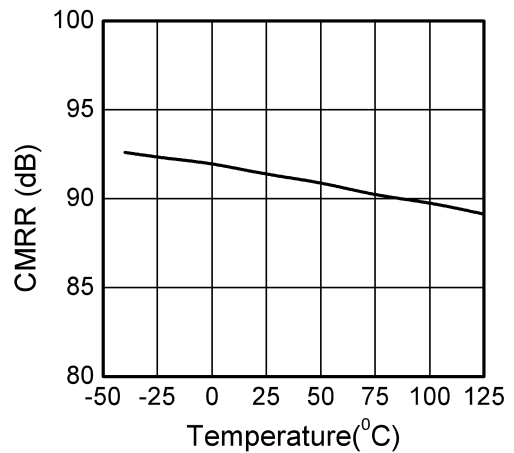
Phase Margin vs. C_{load} (Stable for Any C_{load})

Input Voltage Noise Spectral Density

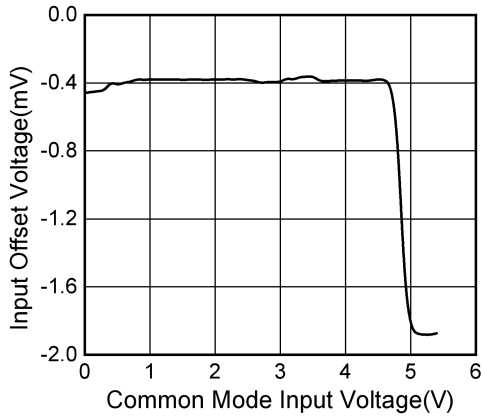
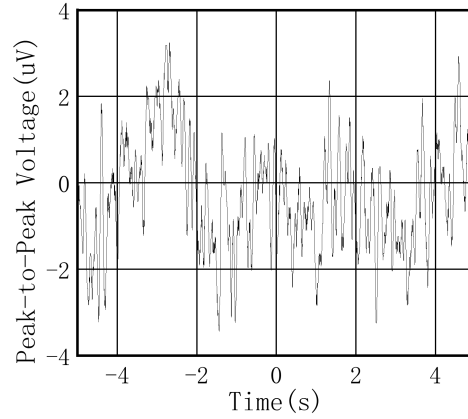
CMRR vs. Frequency

Typical Characteristics (continued)
 $T_A=25^{\circ}\text{C}$, $V_S=5\text{V}$, $V_{\text{CM}}=V_S/2$, unless otherwise noted

Typical Characteristics (continued)
 $T_A=25^{\circ}\text{C}$, $V_S=5\text{V}$, $V_{CM}=V_S/2$, unless otherwise noted

Quiescent Supply Current vs. Temperature

Quiescent Supply Current vs. Supply Voltage

Short-Circuit Current vs. Supply Voltage

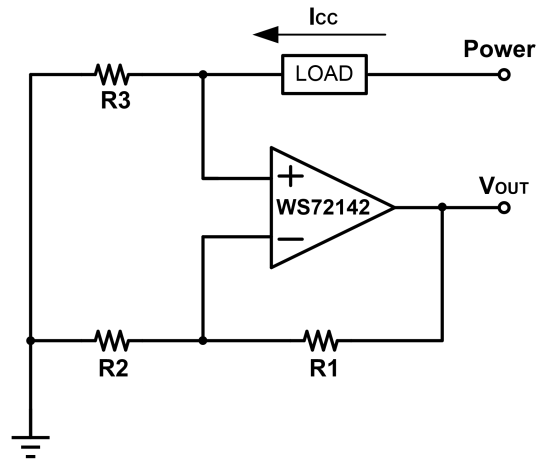
Closed-Loop Output Impedance vs. Frequency

PSRR vs. Temperature

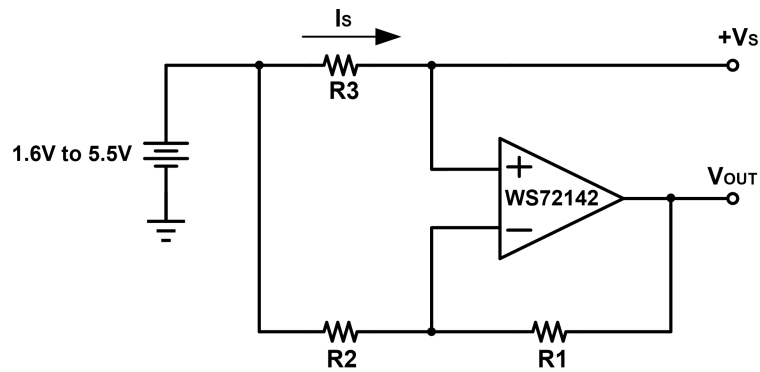
CMRR vs. Temperature

Typical Characteristics (continued)
 $T_A=25^{\circ}\text{C}$, $V_S=5\text{V}$, $V_{\text{CM}}=V_S/2$, unless otherwise noted

Input Offset Voltage vs. Common Mode Input Voltage

0.1Hz to 10Hz Time Domain Output Voltage Noise

Application Circuit
(1) WS72142 in Low Side Battery Current Sensor

Application Circuit for Low Side Battery Current Sensor

$$V_{OUT} = I_{CC} \times R_3 \times \left(\frac{R_1}{R_2} + 1 \right)$$

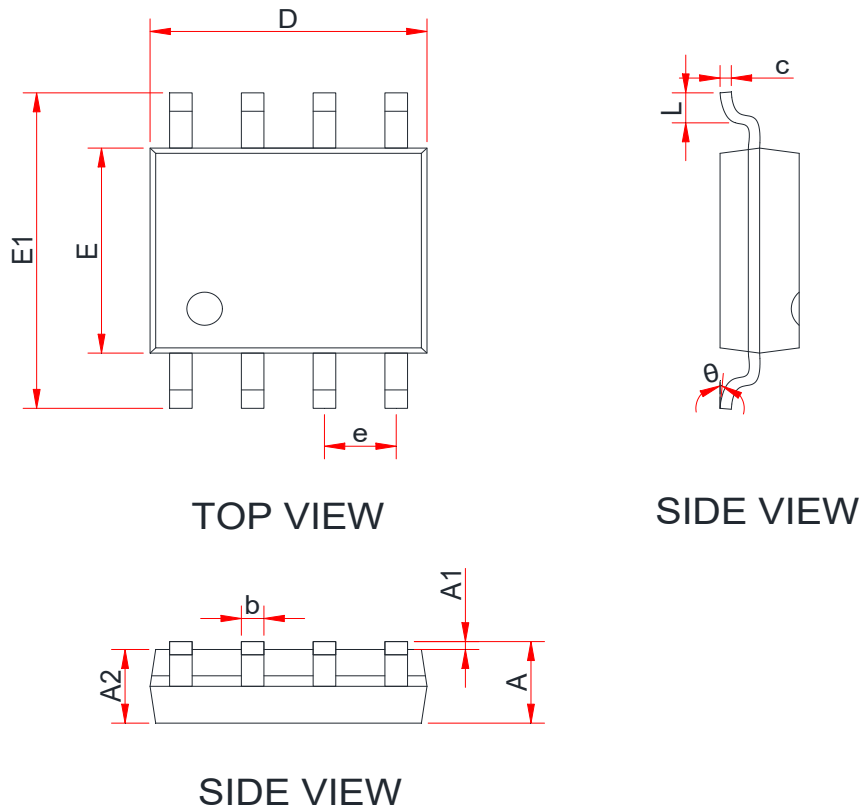
(2) WS72142 in High Side Battery Current Sensor

Application Circuit for High Side Battery Current Sensor

$$I_S = \frac{+V_S - V_{OUT}}{R_1 \times R_3 \div R_2}$$

PACKAGE OUTLINE DIMENSIONS
SOP-8L

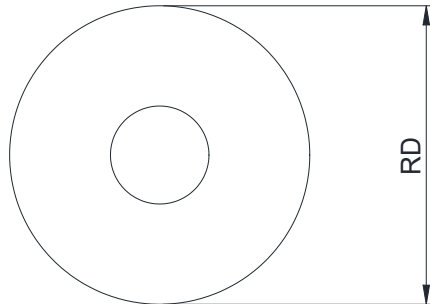
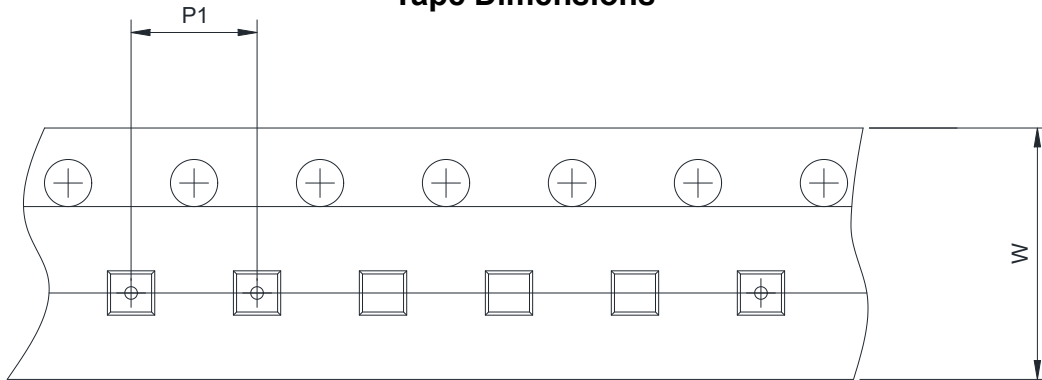
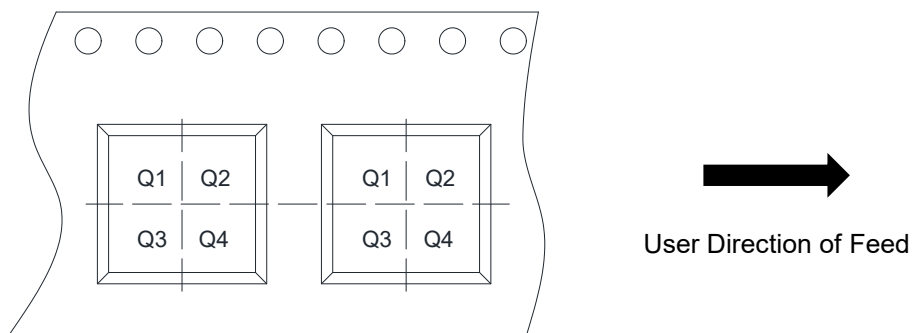
Symbol	Dimensions In Millimeters (mm)		
	Min.	Typ.	Max.
A	1.35	1.55	1.75
A1	0.05	0.15	0.25
A2	1.25	1.40	1.65
b	0.33	-	0.51
c	0.15	-	0.26
D	4.70	4.90	5.10
E	3.70	3.90	4.10
E1	5.80	6.00	6.20
e	1.27BSC		
L	0.40	-	1.27
θ	0°	-	8°

TAPE AND REEL INFORMATION
SOP-8L
Reel Dimensions

Tape Dimensions

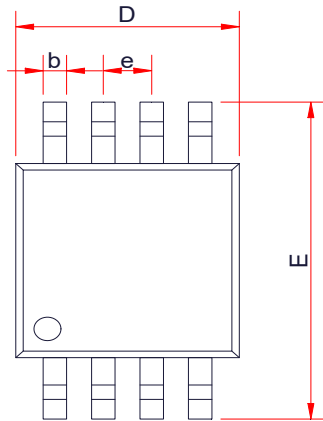
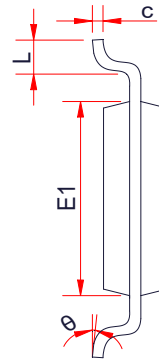
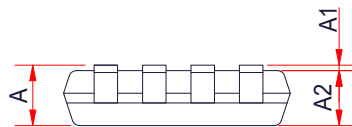
Quadrant Assignments For PIN1 Orientation In Tape

RD	Reel Dimension	<input type="checkbox"/> 7inch	<input checked="" type="checkbox"/> 13inch		
W	Overall width of the carrier tape	<input type="checkbox"/> 8mm	<input checked="" type="checkbox"/> 12mm		
P1	Pitch between successive cavity centers	<input type="checkbox"/> 2mm	<input type="checkbox"/> 4mm	<input checked="" type="checkbox"/> 8mm	
Pin1	Pin1 Quadrant	<input checked="" type="checkbox"/> Q1	<input type="checkbox"/> Q2	<input type="checkbox"/> Q3	<input type="checkbox"/> Q4

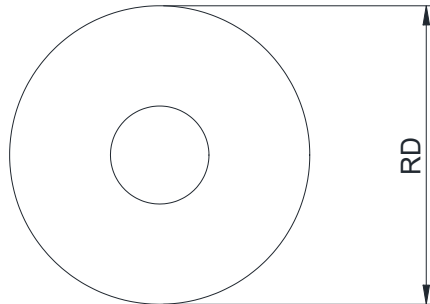
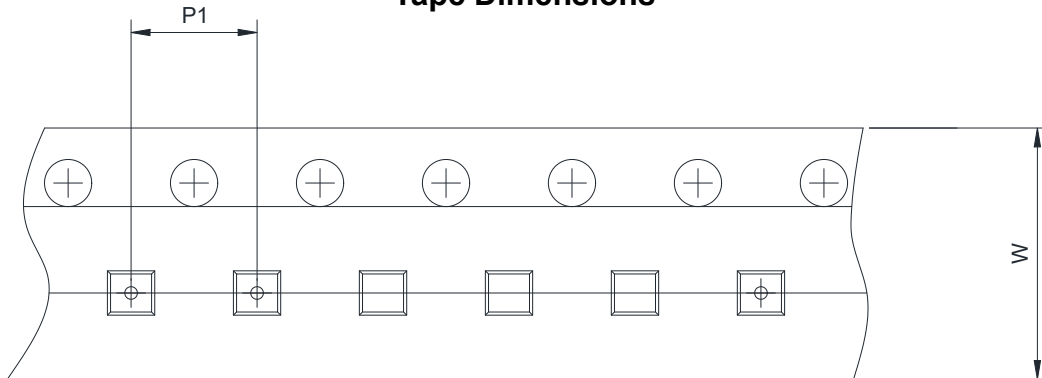
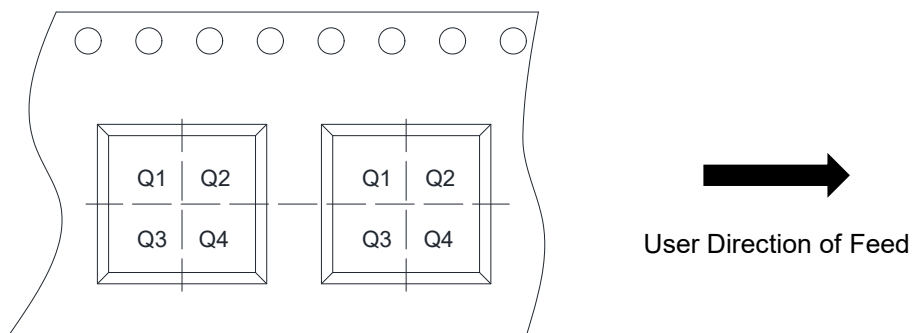
PACKAGE OUTLINE DIMENSIONS
MSOP-8L

TOP VIEW

SIDE VIEW

SIDE VIEW

Symbol	Dimensions In Millimeters (mm)		
	Min.	Typ.	Max.
A	-	-	1.10
A1	0.02	-	0.15
A2	0.75	0.80	0.95
b	0.25	-	0.38
c	0.09	-	0.23
D	2.90	3.00	3.10
E	4.75	4.90	5.05
E1	2.90	3.00	3.10
e	0.65 BSC		
L	0.40	-	0.80
θ	0°	-	6°

TAPE AND REEL INFORMATION
MSOP-8L
Reel Dimensions

Tape Dimensions

Quadrant Assignments For PIN1 Orientation In Tape

RD	Reel Dimension	<input type="checkbox"/> 7inch	<input checked="" type="checkbox"/> 13inch		
W	Overall width of the carrier tape	<input type="checkbox"/> 8mm	<input checked="" type="checkbox"/> 12mm		
P1	Pitch between successive cavity centers	<input type="checkbox"/> 2mm	<input type="checkbox"/> 4mm	<input checked="" type="checkbox"/> 8mm	
Pin1	Pin1 Quadrant	<input checked="" type="checkbox"/> Q1	<input type="checkbox"/> Q2	<input type="checkbox"/> Q3	<input type="checkbox"/> Q4

X-ON Electronics

Largest Supplier of Electrical and Electronic Components

Click to view similar products for [Operational Amplifiers - Op Amps](#) category:

Click to view products by [Will Semiconductor](#) manufacturer:

Other Similar products are found below :

[OPA2991IDSGR](#) [OPA607IDCKT](#) [007614D](#) [633773R](#) [635798C](#) [635801A](#) [702115D](#) [709228FB](#) [741528D](#) [NCV33072ADR2G](#)
[SC2902DTBR2G](#) [SC2903DR2G](#) [SC2903VDR2G](#) [LM258AYDT](#) [LM358SNG](#) [430227FB](#) [430228DB](#) [460932C](#) [AZV831KTR-G1](#) [409256CB](#)
[430232AB](#) [LM2904DR2GH](#) [LM358YDT](#) [LT1678IS8](#) [042225DB](#) [058184EB](#) [070530X](#) [SC224DR2G](#) [SC239DR2G](#) [SC2902DG](#)
[SCYA5230DR2G](#) [714228XB](#) [714846BB](#) [873836HB](#) [MIC918YC5-TR](#) [TS912BIYDT](#) [NCS2004MUTAG](#) [NCV33202DMR2G](#)
[M38510/13101BPA](#) [NTE925](#) [SC2904DR2G](#) [SC358DR2G](#) [LM358EDR2G](#) [AZV358MTR-G1](#) [AP4310AUMTR-AG1](#) [HA1630D02MMEL-E](#)
[NJM358CG-TE2](#) [HA1630S01LPEL-E](#) [LM324AWPT](#) [HA1630Q06TELL-E](#)