

WS722377

13MHz Low Noise CMOS Operational Amplifiers

[Http://www.omnivision-group.com](http://www.omnivision-group.com)

Descriptions

WS722377 is wide bandwidth CMOS amplifier that provides very low noise, low input bias current, and low offset voltage while operating on a low quiescent current of 1.3mA per channel.

WS722377 is optimized for low voltage, single supply applications. The exceptional combination of ac and dc performance make them ideal for a wide range of applications, including small signal conditioning, audio, and active filters. In addition, these parts have a wide supply range with excellent PSRR, making them attractive for applications that run directly from batteries without regulation.

The WS722377 is available with MSL 3 Level in SOP-8L, MSOP-8L and DFN3x3-8L packages. Standard products are Pb-Free and halogen-Free.

Features

- Gain Bandwidth Product : 13.7 MHz
- Low Noise @1kHz : 7 nV/√Hz
- Offset Voltage : 25 uV
- Input Bias Current : 5 pA
- Quiescent Current per OPA : 1.3 mA
- Supply Voltage Range : 2.1~5.5 V
- Rail-to-Rail Output Swing
- Unity Gain Stable
- EMI Input Filtering
- -40°C to 125°C Operation Range

Applications

- Photo Diode Pre-Amp
- Piezoelectric Sensor Pre-Amp
- Sensor Signal Conditioning
- Audio Equipment
- Active Filter

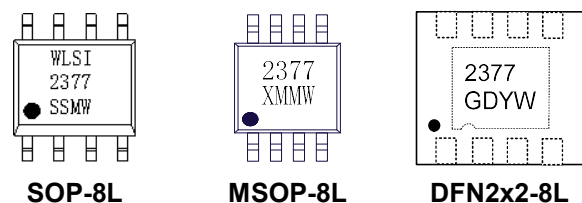
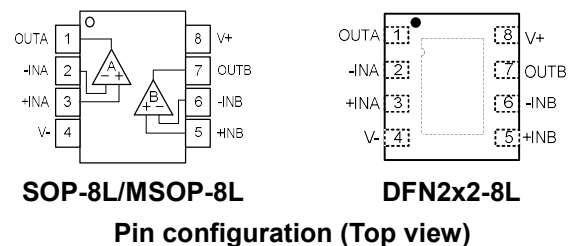

Marking

- 2377** = Device code
SS, XM, GD = Special code
Y = Year code
M = Month code
W = Week code

Order information

Device	Package	Shipping
WS722377S-8/TR	SOP-8L	4000/Reel &Tape
WS722377M-8/TR	MSOP-8L	4000/Reel &Tape
WS722377DA-8/TR	DFN3x3-8L	3000/Reel &Tape

Pin Descriptions

Pin Number	Symbol	Descriptions
1	OUTA	Output A
2	-INA	Inverting input A
3	+INA	Non-inverting input A
4	V-	Negative supply
5	+INB	Non-inverting input B
6	-INB	Inverting input B
7	OUTB	Output B
8	V+	Positive supply

Absolute Maximum Ratings

Parameter		Value	Unit
Supply Voltage, $V_S = (V+) - (V-)$		6	V
Single Input Terminals	Voltage ⁽²⁾	6	V
Output Short-Circuit ⁽³⁾		135	mA
Operating Temperature, T_A		-40~150	°C
Storage Temperature, T_A		-40~150	°C
Junction Temperature, T_J		-40~150	°C
ESD Rating	Human Body Model	8000	V
	Charged Device Model	2000	V
	Machine Model	300	V

Note:

- Stresses above these ratings may cause permanent damage. Exposure to absolute maximum conditions for extended periods may degrade device reliability. These are stress ratings only, and functional operation of the device at these or any other conditions beyond those specified is not supported.
- Input terminals are diode-clamped to the power-supply rails. Input signals that can swing more than 0.5V beyond the supply rails should be current limited to 10mA or less.
- Short-circuit to ground, one amplifier per package. Differential voltages are at +IN with respect to -IN.

Electronics Characteristics: $V_S = +2.2\text{ V to }+5.5\text{ V}$
 $T_A = 25^\circ\text{C}$, $R_L = 10\text{ k}\Omega$, connected to $V_S/2$, $V_{CM} = V_{OUT} = V_S/2$, unless otherwise noted..

Parameters	Conditions	Min.	Typ.	Max.	Unit
Offset Voltage					
Input Offset Voltage	V_{OS} $V_S = +5\text{V}$		25		μV
Input Offset Voltage versus Power Supply	PSRR $V_S = +2.4\text{V to }+5.5\text{V}$, $V_{CM} = V_S/2$	78	95		dB
Input Bias Current					
Input Bias Current	I_B		5		μA
Input Offset Current	I_{OS}		10		μA
Noise					
Input Voltage Noise	$f=0.1\text{Hz to }10\text{Hz}$		1.2		μV_{P-P}
Input Voltage Noise Density	$f=1\text{kHz}$		7		$\text{nV}/\sqrt{\text{Hz}}$
Input Current Noise	$f=10\text{kHz}$		4		$\text{nV}/\sqrt{\text{Hz}}$
Input Voltage Range					
Common Mode Voltage Range	V_{CM}		$(V_-) - 0.1$		$(V_+) + 0.1$ V
Common Mode Rejection Ratio	CMRR $(V_-) - 0.1\text{V} < V_{CM} < (V_+) + 0.1\text{V}$	73	93		dB
Input Capacitance					
Differential			5		pF
Common-Mode			10		pF
Open Loop Gain					
Open Loop Voltage Gain	A_{OL} $100\text{mV} < V_O < (V_+) - 100\text{mV}$, $R_L=10\text{k}\Omega$	98	136		dB
Frequency Response					
Gain-Bandwidth Product	GBW		13.7		MHz
Slew Rate	SR $G = +1$		7		$\text{V}/\mu\text{s}$
Settling Time 0.1%	t_S 2V Step , $G = +1$		0.4		μs
Settling Time 0.01%	t_S 2V Step , $G = +1$		0.5		μs
Overload Recover Time	$V_{IN} \times \text{Gain} > V_S$		0.3		μs
Output					
Voltage Output Swing from Rail	$R_L = 10\text{ k}\Omega$		4		mV
Short-Circuit Current	I_{SC}	78	115		mA
Capacitive Load Drive	C_{LOAD}		100		pF
Open-Loop Output Impedance	R_O		6		Ω
Power Supply					
Specified Voltage Range	V_S $I_O=0$, $V_S = +5.5\text{V}$	2.1		5.5	V
Quiescent Current per Amplifier	I_Q		1.3	1.8	mA

Typical Characteristics

$T_A = 25^\circ\text{C}$, $V_S = +5\text{V}$, $R_L = 10\text{k}\Omega$ connected to $V_S/2$, $V_{CM} = V_S/2$, and $V_{OUT} = V_S/2$, unless otherwise noted.

Open-Loop Gain and Phase

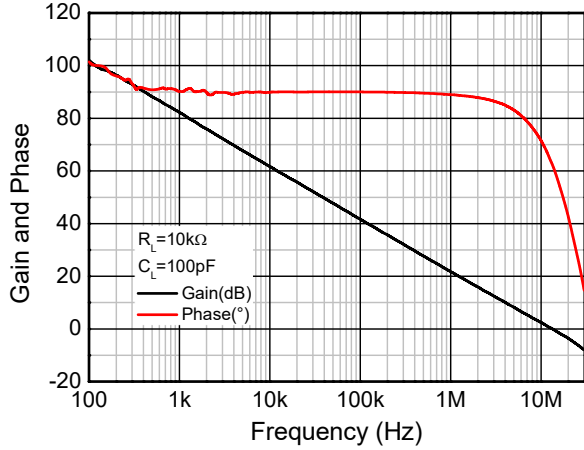

CMRR vs. Frequency

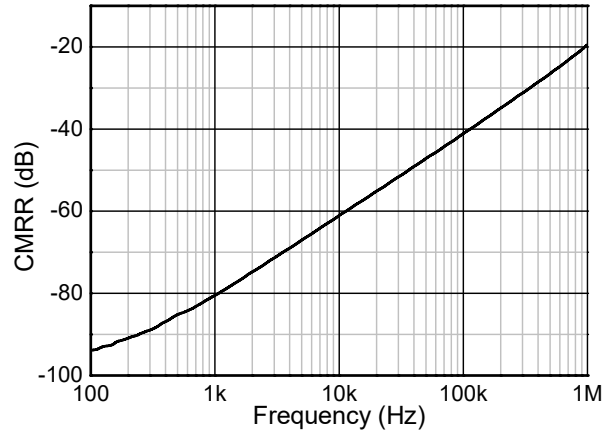

PSRR vs. Frequency

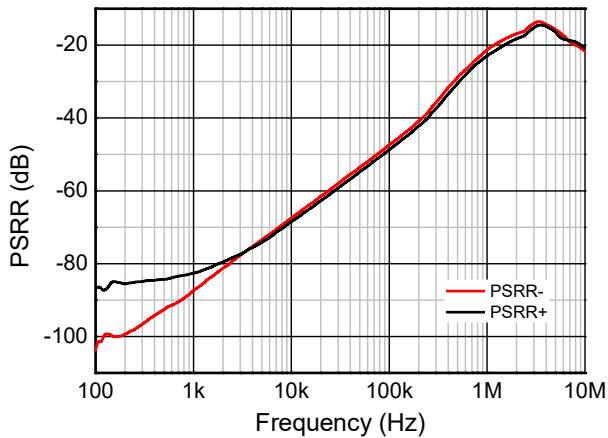

0.1Hz to 10Hz Input Voltage Noise

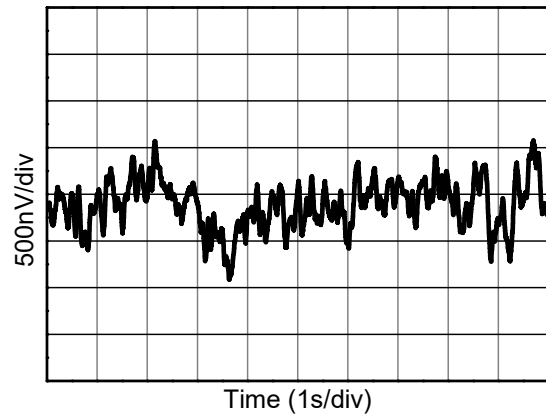

Input Voltage Noise Spectral Density

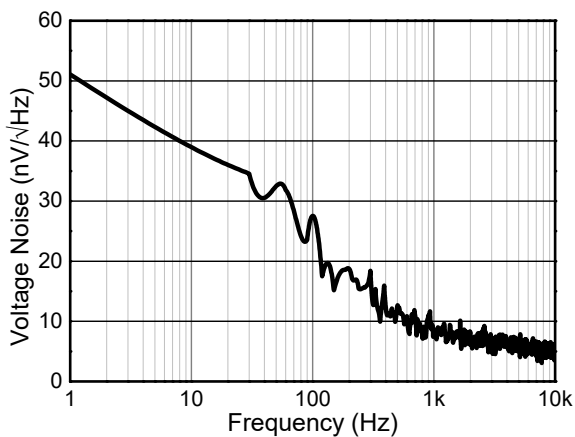

Overload Recovery

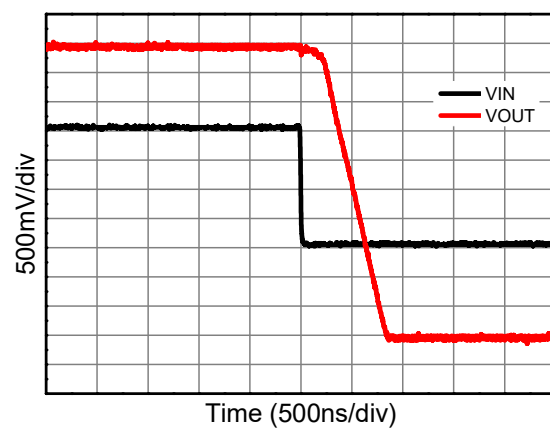

Typical Characteristics (continued)

$T_A = 25^\circ\text{C}$, $V_S = +5\text{V}$, $R_L = 10\text{k}\Omega$ connected to $V_S/2$, $V_{CM} = V_S/2$, and $V_{OUT} = V_S/2$, unless otherwise noted.

Small-Signal Pulse Response, 100mV Step

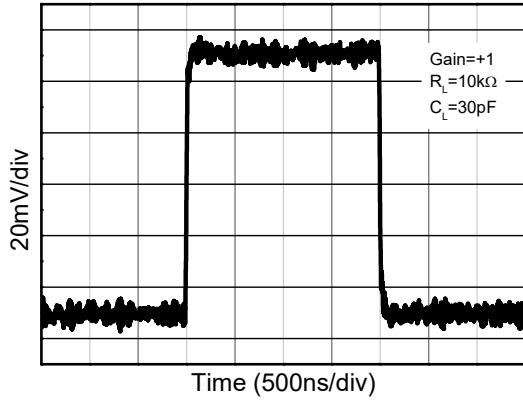

Large Signal Pulse Response, 2V Step

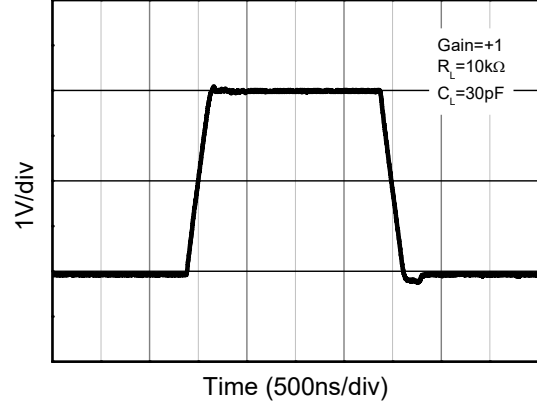

Quiescent Current vs. Temperature

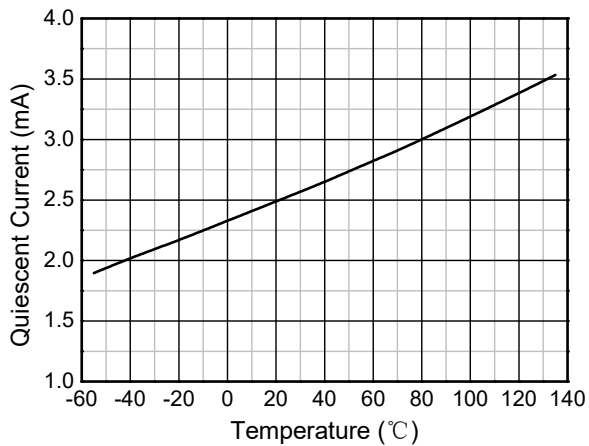

Output Voltage vs. Output Current

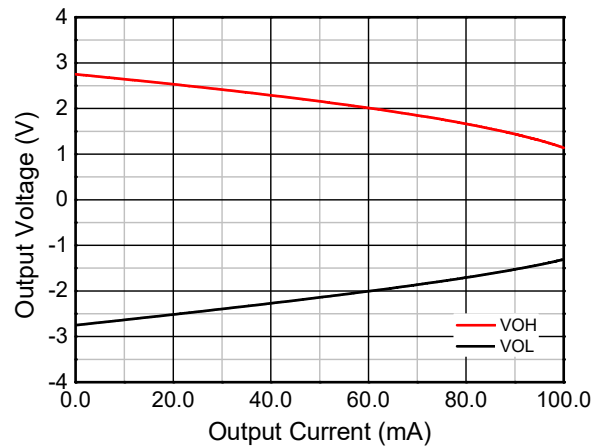

Quiescent and Short-Circuit Current vs. Supply Voltage

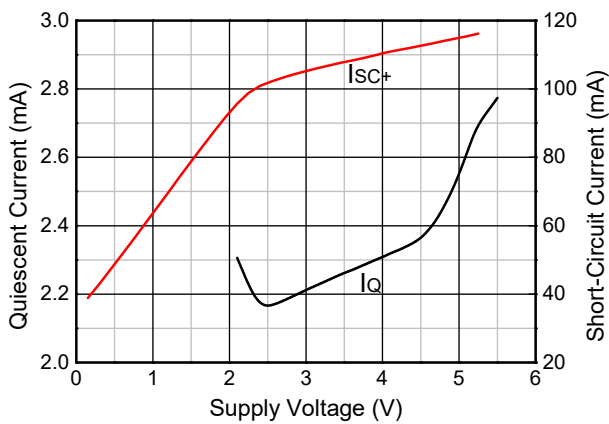

Maximum Output Voltage vs. Frequency

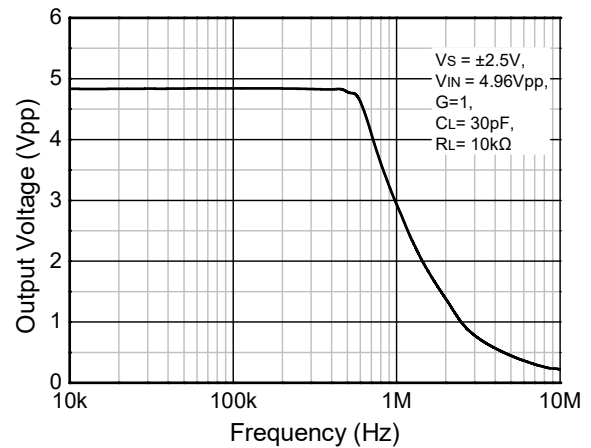

Typical Characteristics (continued)

$T_A = 25^\circ\text{C}$, $V_S = +5\text{V}$, $R_L = 10\text{k}\Omega$ connected to $V_S/2$, $V_{CM} = V_S/2$, and $V_{OUT} = V_S/2$, unless otherwise noted.

Open-Loop Output Resistance vs. Frequency

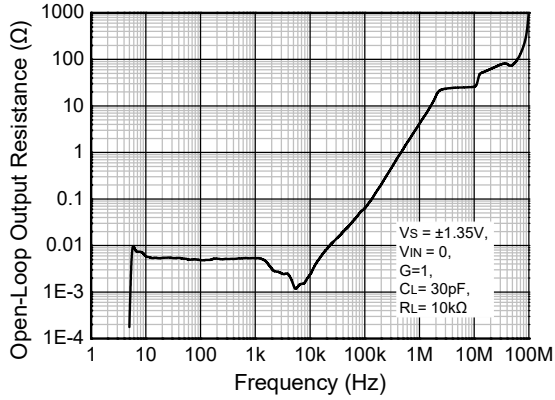

No Phase Reversal

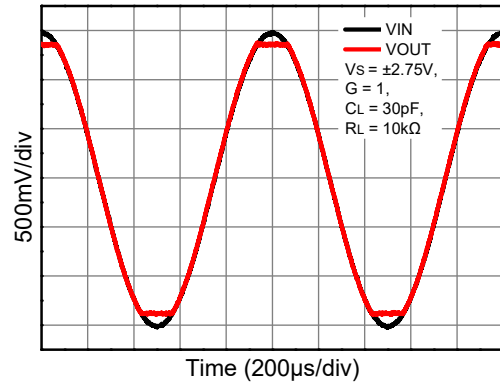

Crosstalk

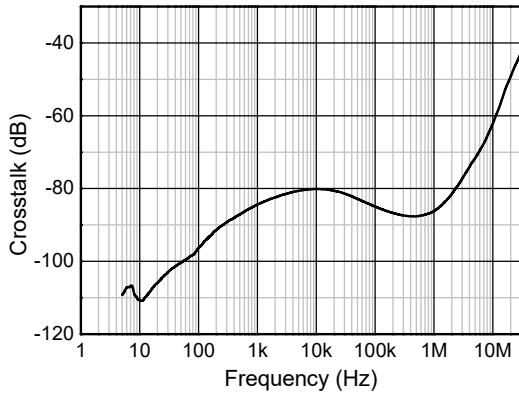

Output Voltage vs. Output Current

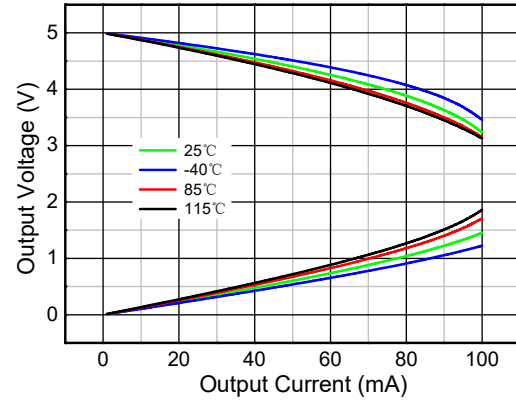

Input Offset Voltage vs. Temperature

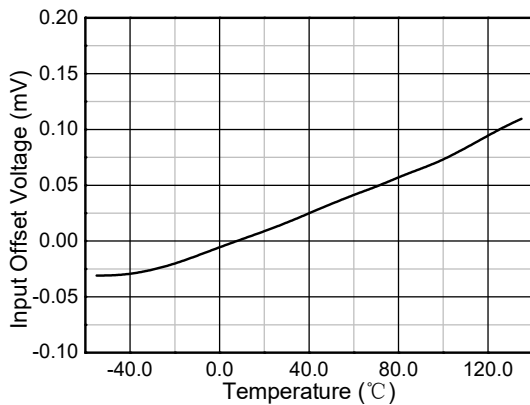

Slew Rate vs. Temperature

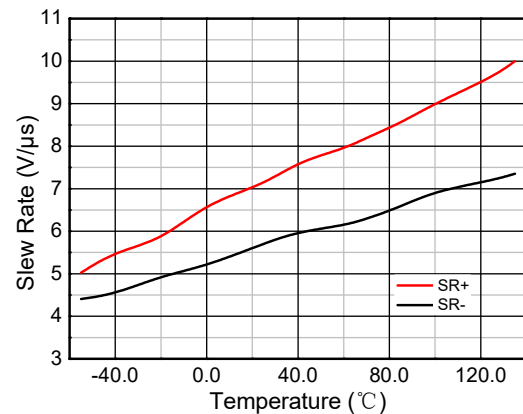

PACKAGE OUTLINE DIMENSIONS

SOP-8L

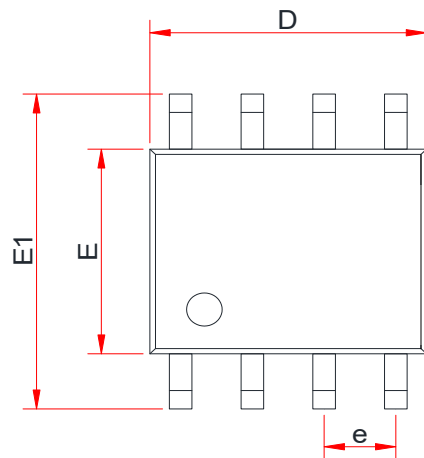

TOP VIEW



SIDE VIEW

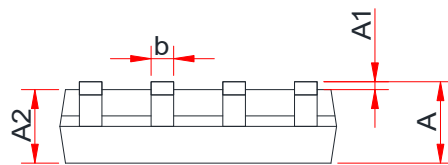

SIDE VIEW

Symbol	Dimensions In Millimeters (mm)		
	Min.	Typ.	Max.
A	1.35	1.55	1.75
A1	0.05	0.15	0.25
A2	1.25	1.40	1.65
b	0.33	-	0.51
c	0.15	-	0.26
D	4.70	4.90	5.10
E	3.70	3.90	4.10
E1	5.80	6.00	6.20
e	1.27BSC		
L	0.40	-	1.27
θ	0°	-	8°

TAPE AND REEL INFORMATION

SOP-8L

Reel Dimensions

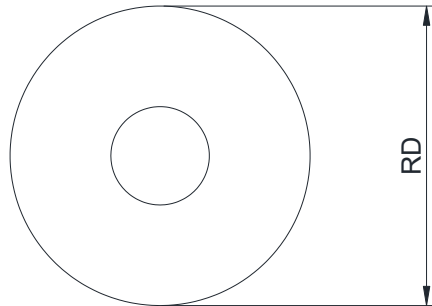

Tape Dimensions

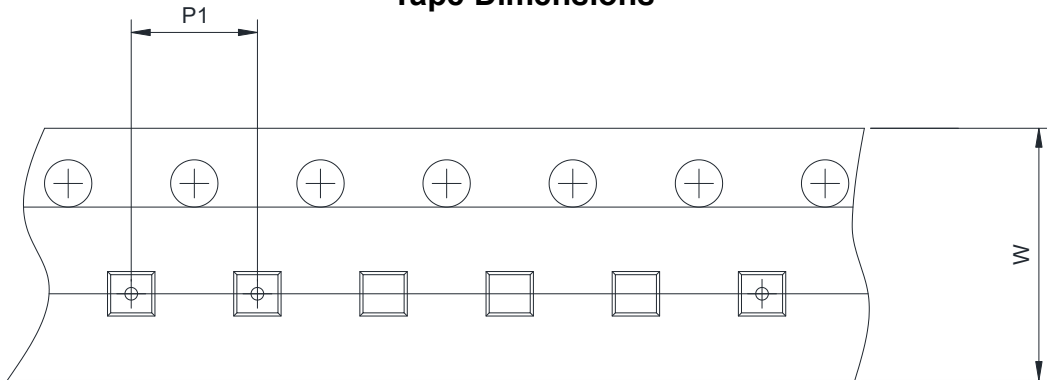

Quadrant Assignments For PIN1 Orientation In Tape

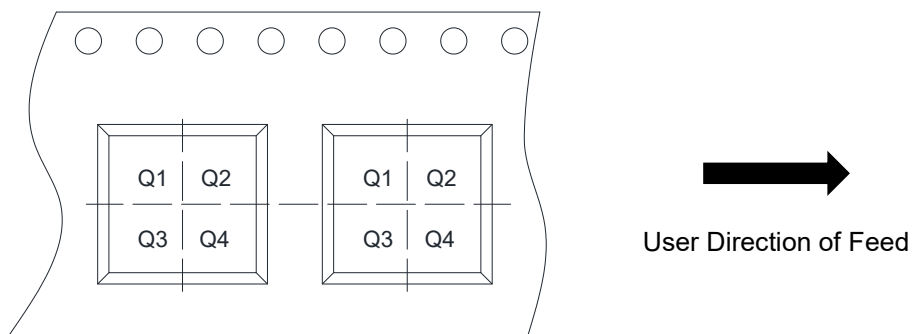

RD	Reel Dimension	<input type="checkbox"/> 7inch	<input checked="" type="checkbox"/> 13inch		
W	Overall width of the carrier tape	<input type="checkbox"/> 8mm	<input checked="" type="checkbox"/> 12mm		
P1	Pitch between successive cavity centers	<input type="checkbox"/> 2mm	<input type="checkbox"/> 4mm	<input checked="" type="checkbox"/> 8mm	
Pin1	Pin1 Quadrant	<input checked="" type="checkbox"/> Q1	<input type="checkbox"/> Q2	<input type="checkbox"/> Q3	<input type="checkbox"/> Q4

PACKAGE OUTLINE DIMENSIONS

MSOP-8L

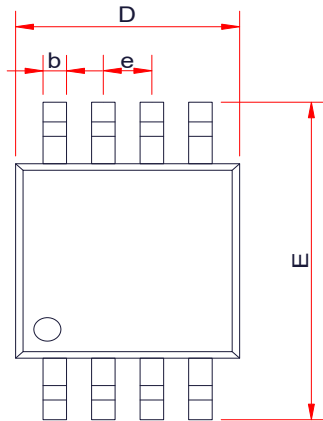

TOP VIEW

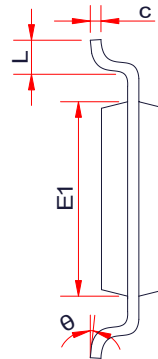

SIDE VIEW

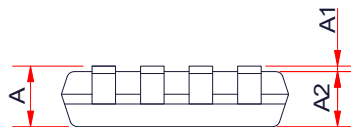

SIDE VIEW

Symbol	Dimensions In Millimeters (mm)		
	Min.	Typ.	Max.
A	-	-	1.10
A1	0.02	-	0.15
A2	0.75	0.80	0.95
b	0.25	-	0.38
c	0.09	-	0.23
D	2.90	3.00	3.10
E	4.75	4.90	5.05
E1	2.90	3.00	3.10
e	0.65 BSC		
L	0.40	-	0.80
θ	0°	-	6°

TAPE AND REEL INFORMATION

MSOP-8L

Reel Dimensions

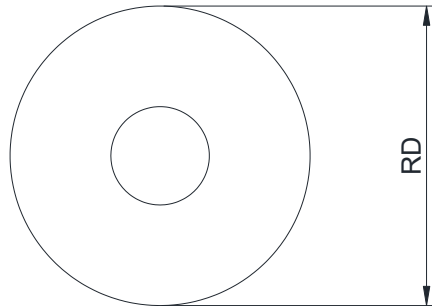

Tape Dimensions

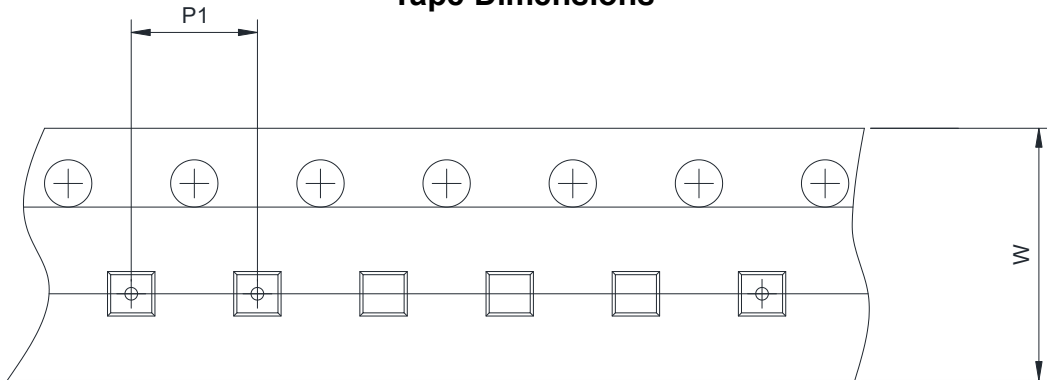

Quadrant Assignments For PIN1 Orientation In Tape

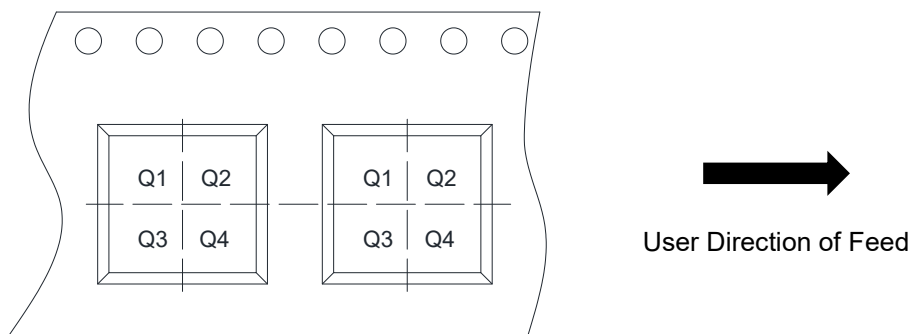

RD	Reel Dimension	<input type="checkbox"/> 7inch	<input checked="" type="checkbox"/> 13inch		
W	Overall width of the carrier tape	<input type="checkbox"/> 8mm	<input checked="" type="checkbox"/> 12mm		
P1	Pitch between successive cavity centers	<input type="checkbox"/> 2mm	<input type="checkbox"/> 4mm	<input checked="" type="checkbox"/> 8mm	
Pin1	Pin1 Quadrant	<input checked="" type="checkbox"/> Q1	<input type="checkbox"/> Q2	<input type="checkbox"/> Q3	<input type="checkbox"/> Q4

PACKAGE OUTLINE DIMENSIONS

DFN3x3-8L

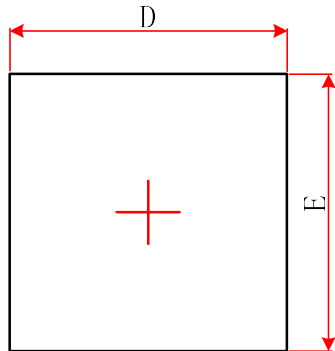

TOP VIEW

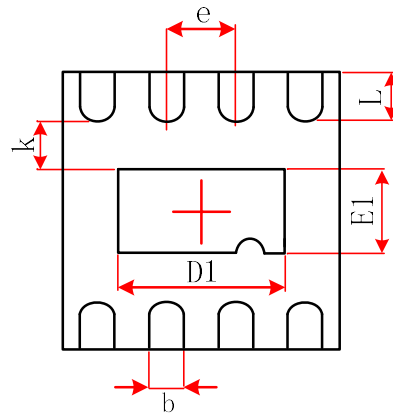

BOTTOM VIEW

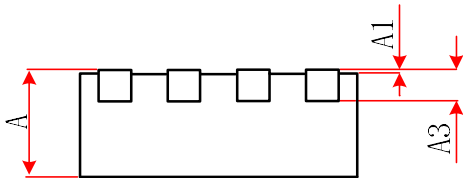

SIDE VIEW

Symbol	Dimensions In Millimeters (mm)		
	Min.	Typ.	Max.
A	0.70	0.75	0.80
A1	0.00	0.02	0.05
A3	0.203REF.		
D	3.00BSC		
E	3.00BSC		
D1	2.20	2.30	2.40
E1	1.40	1.50	1.60
k	0.200	-	-
b	0.25	0.30	0.35
e	0.65BSC		
L	0.25	0.30	0.35

TAPE AND REEL INFORMATION

DFN3x3-8L

Reel Dimensions

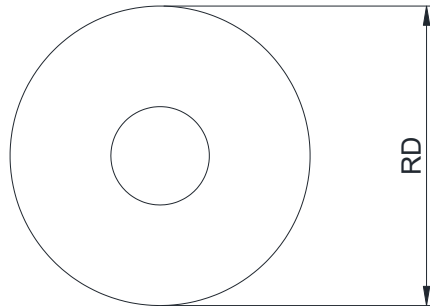

Tape Dimensions

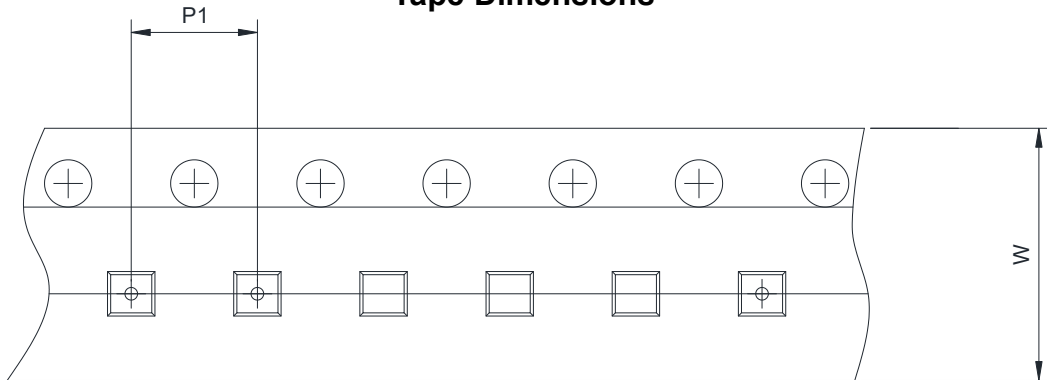

Quadrant Assignments For PIN1 Orientation In Tape

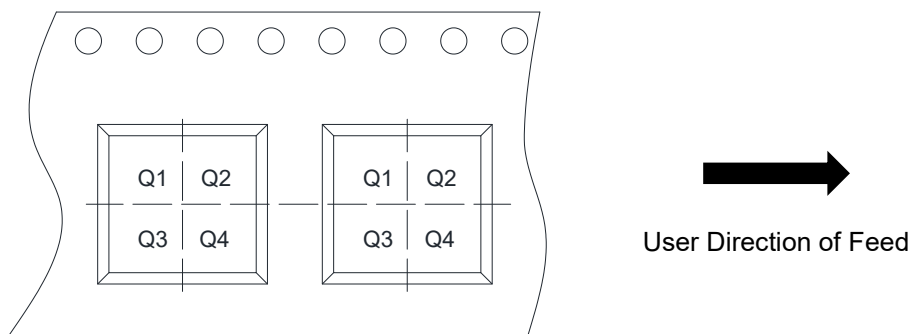

RD	Reel Dimension	<input checked="" type="checkbox"/> 7inch	<input type="checkbox"/> 13inch		
W	Overall width of the carrier tape	<input checked="" type="checkbox"/> 8mm	<input type="checkbox"/> 12mm		
P1	Pitch between successive cavity centers	<input type="checkbox"/> 2mm	<input checked="" type="checkbox"/> 4mm	<input type="checkbox"/> 8mm	
Pin1	Pin1 Quadrant	<input checked="" type="checkbox"/> Q1	<input type="checkbox"/> Q2	<input type="checkbox"/> Q3	<input type="checkbox"/> Q4

X-ON Electronics

Largest Supplier of Electrical and Electronic Components

Click to view similar products for [Operational Amplifiers - Op Amps](#) category:

Click to view products by [Will Semiconductor](#) manufacturer:

Other Similar products are found below :

[430227FB](#) [LT1678IS8](#) [NCV33202DMR2G](#) [NJM324E](#) [M38510/13101BPA](#) [NTE925](#) [AZV358MTR-G1](#) [AP4310AUMTR-AG1](#)
[AZV358MMTR-G1](#) [SCY33178DR2G](#) [NCV20034DR2G](#) [NTE778S](#) [NTE871](#) [NTE937](#) [NJU7057RB1-TE2](#) [SCY6358ADR2G](#)
[NJM2904CRB1-TE1](#) [UPC4570G2-E1-A](#) [UPC4741G2-E1-A](#) [NJM8532RB1-TE1](#) [EL2250CS](#) [EL5100IS](#) [EL5104IS](#) [EL5127CY](#) [EL5127CZY](#)
[EL5133IW](#) [EL5152IS](#) [EL5156IS](#) [EL5162IS](#) [EL5202IY](#) [EL5203IY](#) [EL5204IY](#) [EL5210CS](#) [EL5210CZY](#) [EL5211IYE](#) [EL5220CY](#)
[EL5223CLZ](#) [EL5223CR](#) [EL5224ILZ](#) [EL5227CLZ](#) [EL5227CRZ](#) [EL5244CS](#) [EL5246CS](#) [EL5246CSZ](#) [EL5250IY](#) [EL5251IS](#) [EL5257IS](#)
[EL5260IY](#) [EL5261IS](#) [EL5300IU](#)