

WS72324
Low-Power Rail-to-Rail Input Output Operational Amplifiers
[Http://www.willsemi.com](http://www.willsemi.com)
Descriptions

The WS72324 series is a quad low-voltage operational amplifier with rail-to-rail input/output swing. Ultra low quiescent current makes this amplifier ideal for portable, battery operated equipment. The common mode input range includes ground making the device useful for low-side current-shunt measurements.

The WS72324 is available with MSL 3 Level in SOP-14L package and TSSOP-14L package. Standard products are Pb-Free and halogen-Free.

Applications

- Active Filters
- Smoke/Gas Sensors
- Battery Powered Electronic Equipments
- Personal Medical Care

Features

- Single Supply Voltage : 1.8~5.5V
- Quiescent Current : 42μA Typical
- GBWP : 1.5MHz
- Slew Rate : 1.1V/μs
- Offset Voltage : 3mV Maximum
- Offset Voltage Temp. Drift : 0.2μV / °C
- THD+N : -102dB@1kHz,
-90dB@10kHz
- CMRR/PSRR : 101dB/105dB
- Output Short-Circuit Curr. : 43mA
- -40°C to 125°C Operation Range
- Drives 2kΩ Resistive Loads
- No Output Crossover Distortion
- No Phase Reversal from Overdriven Input
- Rail-to-Rail Input/Output Swing

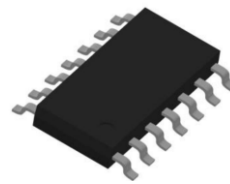
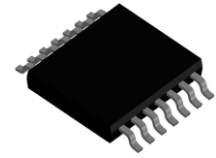
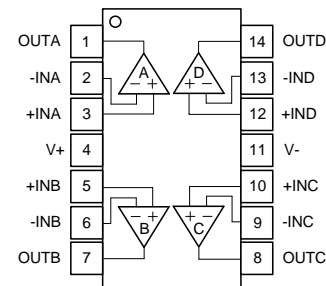
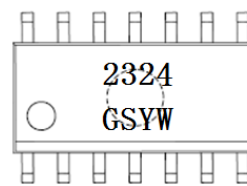
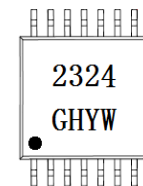
SOP-14L

TSSOP-14L

SOP-14L/TSSOP-14L
Pin configuration (Top view)

SOP-14L

TSSOP-14L
Marking

- 2324** = Device code
- GS** = Special code
- GH** = Special code
- Y** = Year code
- W** = Week code

Order Information

Device	Package	Shipping
WS72324S-14/TR	SOP-14L	4000/Reel &Tape
WS72324H-14/TR	TSSOP-14L	4000/Reel &Tape

Pin Descriptions

Pin Number	Symbol	Descriptions
1	OUTA	Output
2	-INA	Inverting input
3	+INA	Non-inverting input
4	V+	Positive supply
5	+INB	Non-inverting input
6	-INB	Inverting input
7	OUTB	Output
8	OUTC	Output
9	-INC	Inverting input
10	+INC	Non-inverting input
11	V-	Negative supply
12	+IND	Non-inverting input
13	-IND	Inverting input
14	OUTD	Output

Absolute Maximum Ratings

Parameter	Symbol	Value	Unit
Supply Voltage, ([V+] – [V-])	$V_S^{(2)}$	6	V
Input Differential Voltage	$V_{IDR}^{(3)}$	±6	V
Input Common Mode Voltage Range	V_{ICR}	(V ⁻)-0.2 to (V ⁺)+0.2	V
Output Short-Circuit Duration	t_{SO}	Unlimited	/
Operating Free-Air Temperature Range	T_A	-40 to 125	°C
Storage Temperature Range	T_{STG}	-65 to 150	°C
Junction Temperature Range	T_J	150	°C
Lead Temperature Range	T_L	260	°C

Note:

- Stresses beyond those listed under Absolute Maximum Ratings may cause permanent damage to the device. These are only stress ratings, and functional operation of the device at these or any other conditions beyond those indicated under recommended operating conditions are not implied. Exposure to absolute-maximum-rated conditions for extended periods may affect device reliability.
- All voltage values, except differential voltage are with respect to network terminal.
- Differential voltages are at +IN with respect to -IN.

ESD, Electrostatic Discharge Protection

Symbol	Parameter	Condition	Minimum level	Unit
HBM	Human Body Model ESD	MIL-STD-883H Method 3015.8 JEDEC-EIA/JESD22-A114A	±8000	V
MM	Machine Model ESD	JEDEC-EIA/JESD22-A115	±450	V
CDM	Charged Device Model ESD	JEDEC-EIA/JESD22-C101E	±2000	V

Electronics Characteristics

The *denotes the specifications which apply over the full operating temperature range, otherwise specifications are at $T_A = 25^\circ\text{C}$. $V_S = 5\text{V}$, $V_{\text{CM}} = V_{\text{OUT}} = V_S/2$, $R_{\text{load}} = 100\text{k}\Omega$, $C_{\text{load}} = 100\text{pF}$

Symbol	Parameter		Conditions	Min.	Typ.	Max.	Unit	
V_{OS}	Input Offset Voltage		$V_{\text{CM}} = V_S/2$	*	-3.0	± 0.1	3.0	mV
α_{VOS}	Input Offset Voltage Drift				0.2		$\mu\text{V}/^\circ\text{C}$	
I_{IB}	Input Bias Current				10		pA	
I_{OS}	Input Offset Current				10		pA	
V_n	Input Voltage Noise		$f=0.1\text{Hz to }10\text{Hz}$		4.5		$\mu\text{V}_{\text{P-P}}$	
e_n	Input Voltage Noise Density		$f=1\text{kHz}$		30		$\text{nV}/\sqrt{\text{Hz}}$	
			$f=10\text{kHz}$		23			
CMRR	Common Mode Rejection Ratio		$V_{\text{CM}}=0.1\text{V to }4.9\text{V}$	*	80	101		dB
V_{CM}	Common Mode Input Voltage Range			*	$(V^-)-0.2$		$(V^+)+0.2$	V
PSRR	Power Supply Rejection Ratio			*	85	105		dB
A_{VOL}	Open Loop Large Signal Gain		$V_{\text{OUT}}=0.1\text{V to }4.9\text{V}$, $R_{\text{load}}=10\text{k}\Omega$	*	100	109		dB
V_{OH}	High Level Output Voltage		$R_{\text{load}}=2\text{k}\Omega$			50		mV
			$R_{\text{load}}=10\text{k}\Omega$			5		
V_{OL}	Low Level Output Voltage		$R_{\text{load}}=2\text{k}\Omega$			40		mV
			$R_{\text{load}}=10\text{k}\Omega$			5		
I_{SC}	Output Short-Circuit Current		Source Current			43		mA
			Sink Current			47		
I_{Q}	Quiescent Current per Amplifier			*		42	62.5	μA
PM	Phase Margin		$R_{\text{load}}=100\text{k}\Omega$, $C_{\text{load}}=100\text{pF}$			60		degrees
GM	Gain Margin		$R_{\text{load}}=100\text{k}\Omega$, $C_{\text{load}}=100\text{pF}$			-14		dB
GBWP	Gain-Bandwidth Product		$f=1\text{kHz}$			1.5		MHz
t_s	Settling Time	1.5 to 3.5V, Unity Gain	0.1%			1.9		μs
		2.45 to 2.55V, Unity Gain	0.1%			0.29		
SR	Slew Rate		$A_V=1$, $V_{\text{OUT}}=1.5\text{V to }3.5\text{V}$, $R_{\text{load}}=100\text{k}\Omega$, $C_{\text{load}}=100\text{pF}$			1.1		$\text{V}/\mu\text{s}$
FPBW	Full Power Bandwidth		$2V_{\text{P-P}}$			180		kHz
THD+N	Total Harmonic Distortion and Noise		$f=1\text{kHz}$, $A_V=1$, $R_{\text{load}}=100\text{k}\Omega$, $V_{\text{OUT}}=2V_{\text{PP}}$			-102		dB
			$f=10\text{kHz}$, $A_V=1$, $R_{\text{load}}=100\text{k}\Omega$, $V_{\text{OUT}}=2V_{\text{PP}}$			-90		

Note:

1. Stresses beyond those listed under Absolute Maximum Ratings may cause permanent damage to the device. Exposure to any Absolute Maximum Rating condition for extended periods may affect device reliability and lifetime.
2. A heat sink may be required to keep the junction temperature below the absolute maximum rating when the output is shorted indefinitely.
3. Thermal resistance varies with the amount of PC board metal connected to the package. The specified values are for short traces connected to the leads.
4. Full power bandwidth is calculated from the slew rate $FPBW = SR/(\pi \cdot V_{P-P})$.

Typical Characteristics
 $T_A=25^{\circ}\text{C}$, $V_S=\pm 2.5\text{V}$, $V_{CM}=0\text{V}$, unless otherwise noted

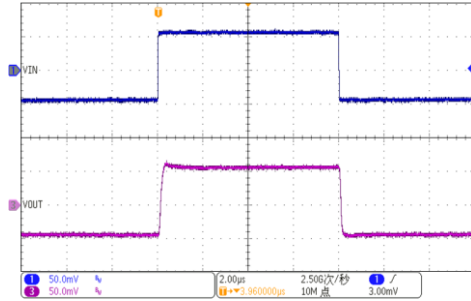
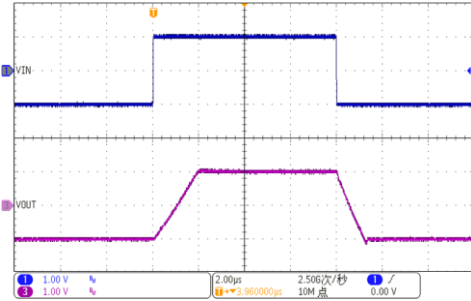
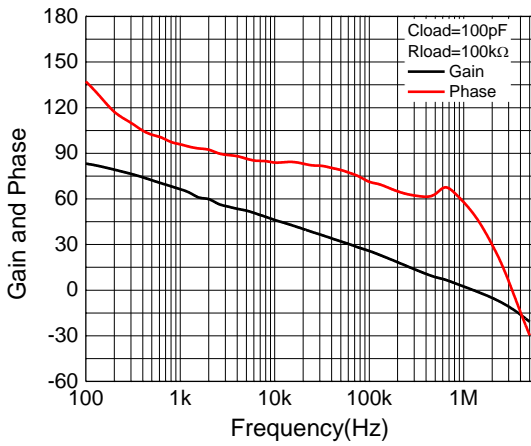
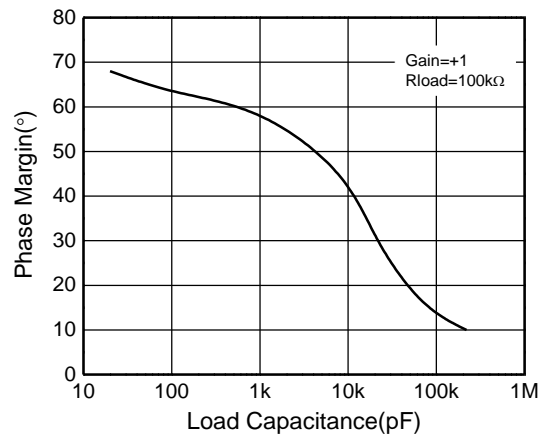
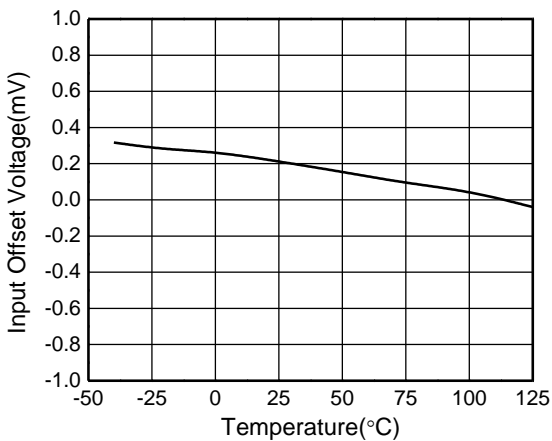
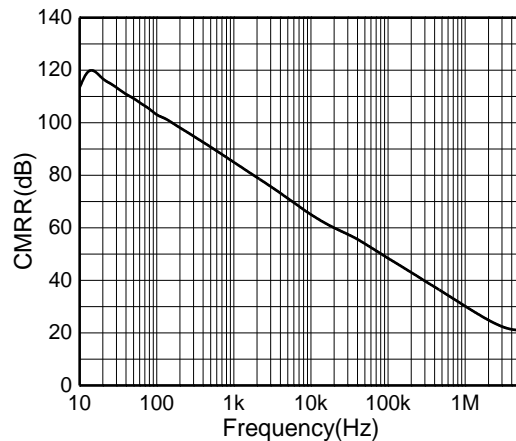
Small-Signal Step Response, 100mV Step

Large-Signal Step Response, 2V Step

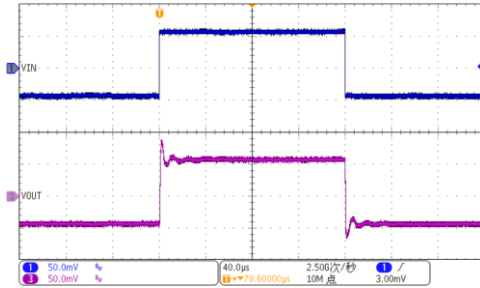
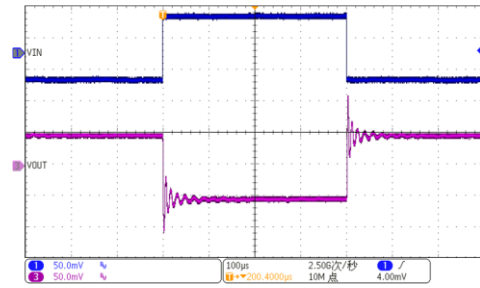
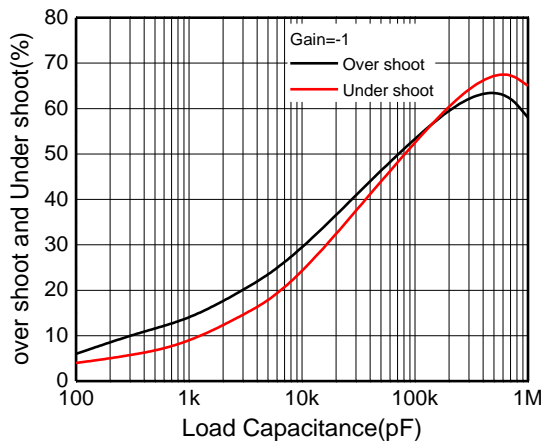
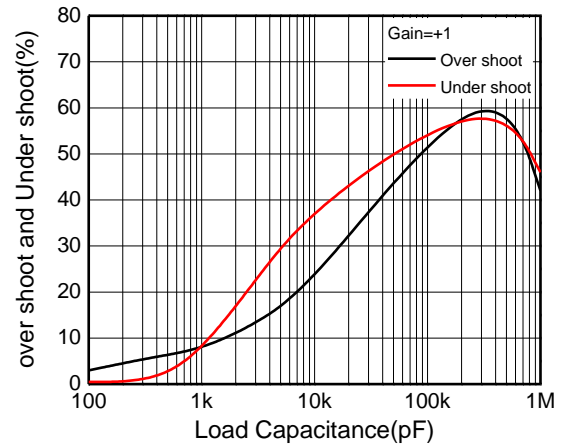
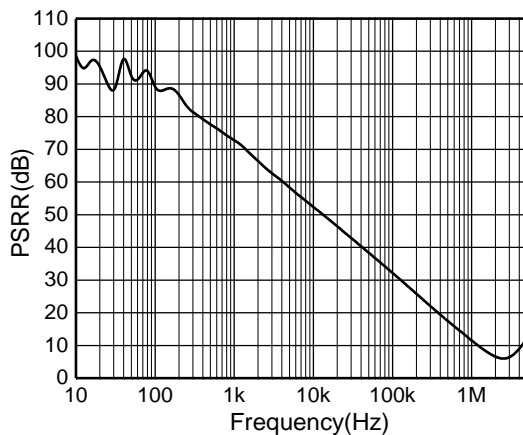
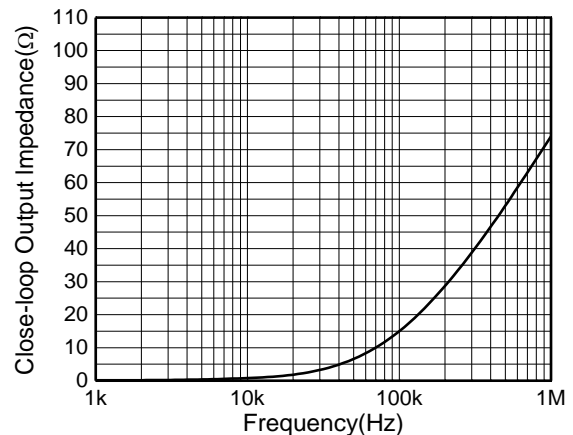
Open-Loop Gain and Phase

Phase Margin vs. C_{load} (Stable for Any C_{load})

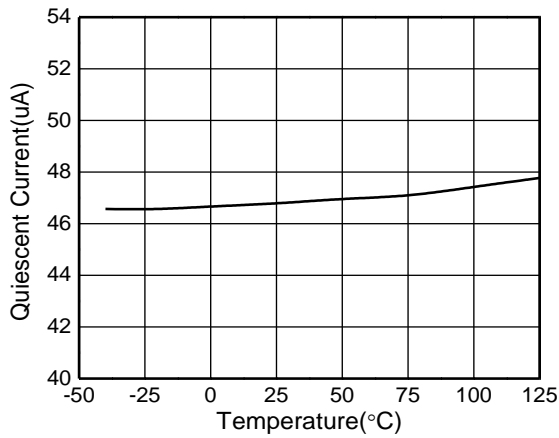
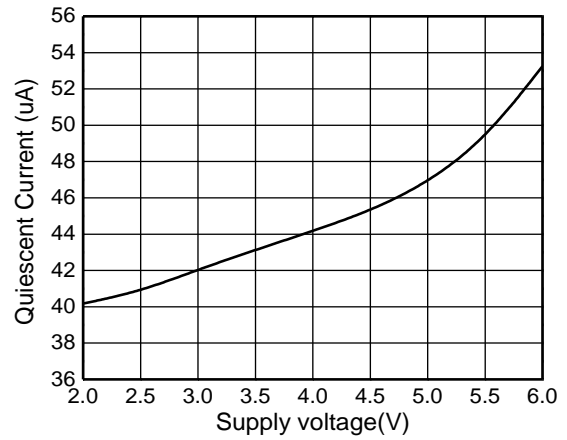
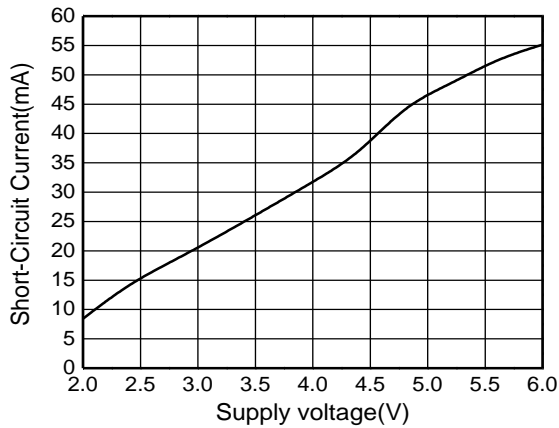
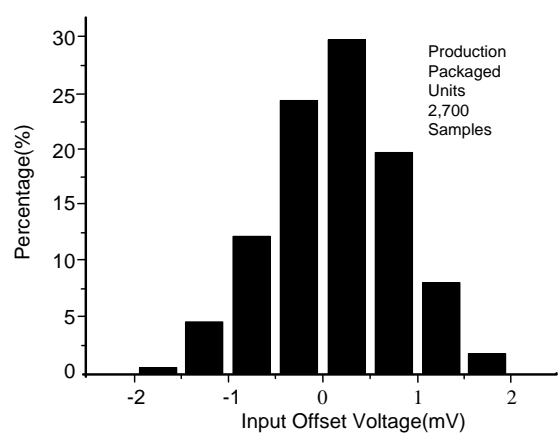
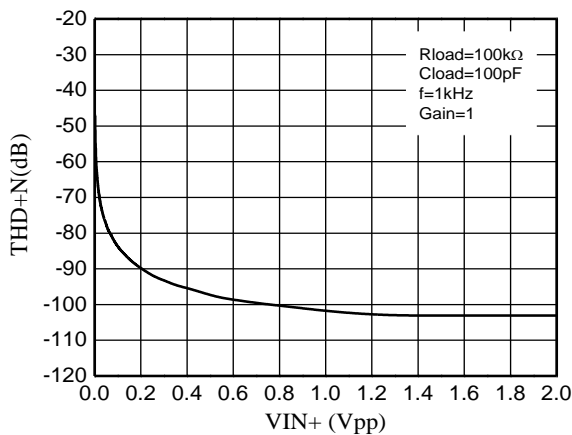
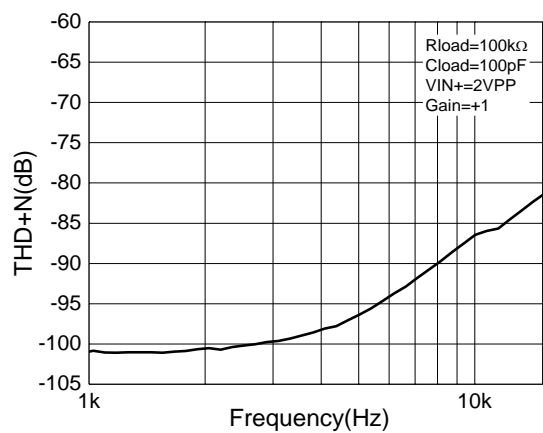
Input Offset Voltage vs. Temperature

CMRR vs. Frequency

Typical Characteristics (continued)
 $T_A=25^\circ\text{C}$, $V_S=\pm 2.5\text{V}$, $V_{CM}=0\text{V}$, unless otherwise noted

**Over Shoot Voltage, $C_{load}=47\text{nF}$,
 $R_{FB}=10\text{k}\Omega$, Gain=+1**

**Over Shoot Voltage, $C_{load}=47\text{nF}$,
 $R_{load}=40\text{k}\Omega$, Gain=-1**

**Over-Shoot % vs. C_{load}
Gain=-1, $R_{FB}=20\text{k}\Omega$**

**Over-Shoot % vs. C_{load}
Gain=+1**

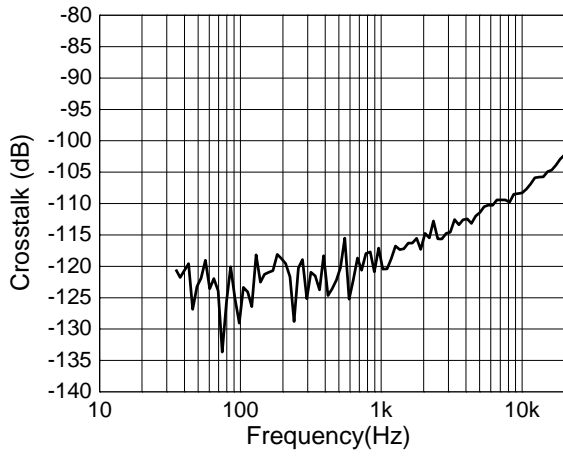
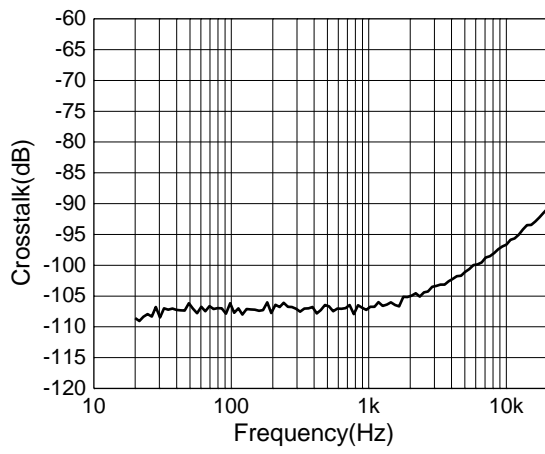
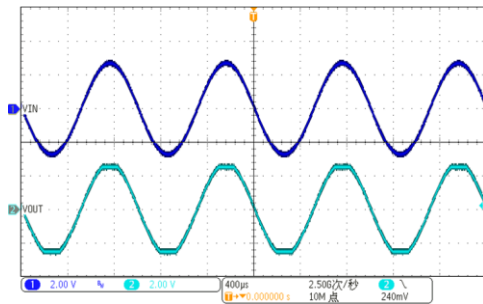
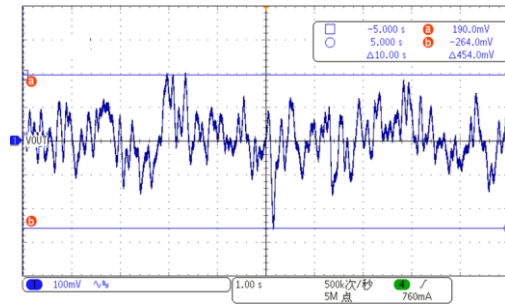
PSRR vs. Frequency

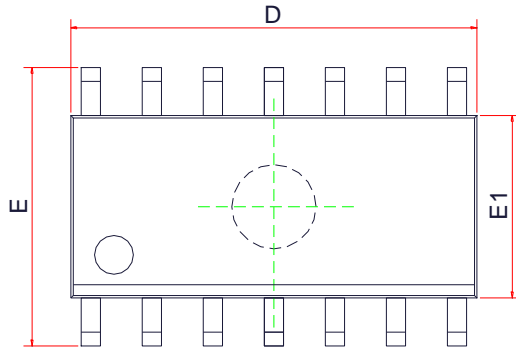
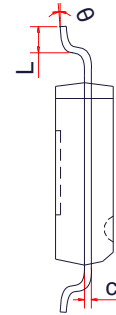
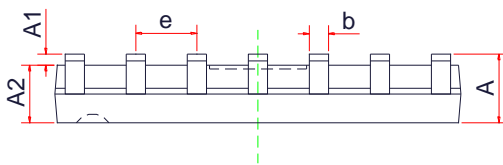
Closed-Loop Output Impedance vs. Frequency

Typical Characteristics (continued)
 $T_A=25^{\circ}\text{C}$, $V_S=\pm 2.5\text{V}$, $V_{CM}=0\text{V}$, unless otherwise noted

Quiescent Supply Current vs. Temperature

Quiescent Supply Current vs. Supply Voltage

Short-Circuit Current vs. Supply Voltage

Input Offset Voltage Distribution

THD+N vs. Vin+

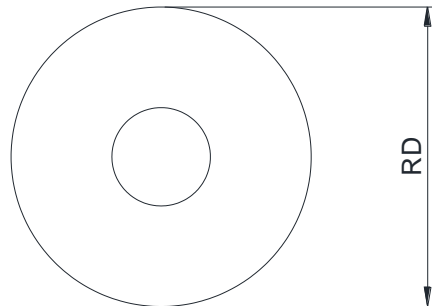
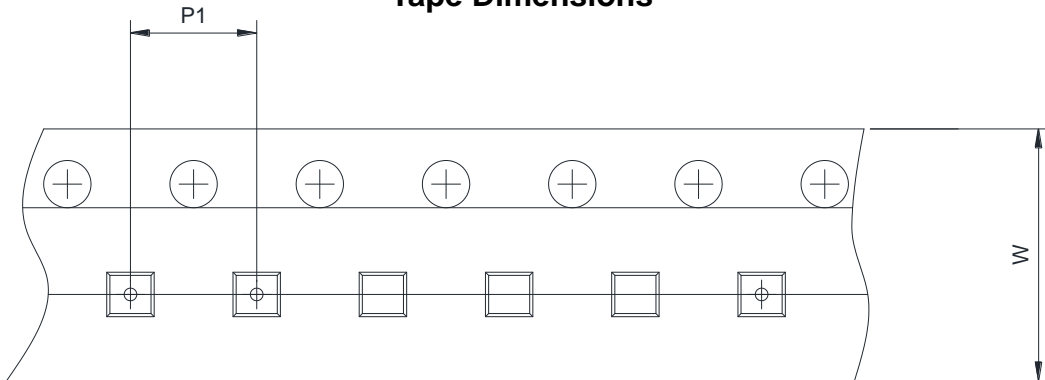
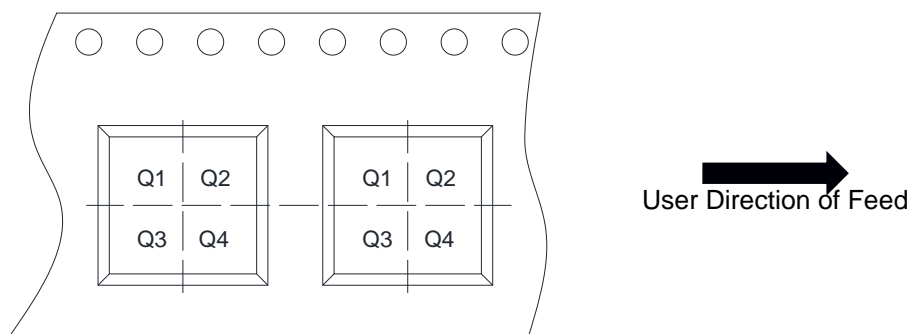
THD+N vs. Frequency

Typical Characteristics (continued)
 $T_A=25^{\circ}\text{C}$, $V_S=\pm 2.5\text{V}$, $V_{CM}=0\text{V}$, unless otherwise noted

Crosstalk, A-Channel to B-Channel

Crosstalk, A-Channel to C-Channel

VIN=-0.2V to 5.7V, No Phase Reversal

0.1Hz to 10Hz Integrated Input Noise, Gain = 10000

PACKAGE OUTLINE DIMENSIONS
SOP-14L

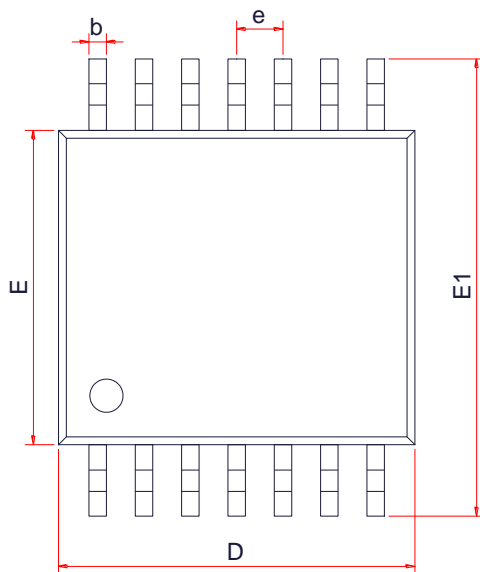
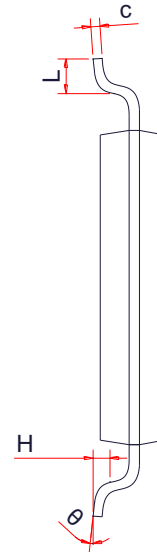
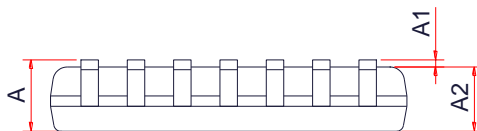
TOP VIEW

SIDE VIEW

SIDE VIEW

Symbol	Dimensions In Millimeters (mm)		
	Min.	Typ.	Max.
A	-	-	1.75
A1	0.10	-	0.25
A2	1.25	-	-
b	0.31	0.41	0.51
c	0.10	-	0.25
D	8.45	8.65	8.85
E	5.80	6.00	6.20
E1	3.80	3.90	4.00
e	1.27 BSC		
L	0.40	-	1.27
θ	0°	-	8°

TAPE AND REEL INFORMATION
Reel Dimensions

Tape Dimensions

Quadrant Assignments For PIN1 Orientation In Tape

RD	Reel Dimension	<input type="checkbox"/> 7inch	<input checked="" type="checkbox"/> 13inch
W	Overall width of the carrier tape	<input type="checkbox"/> 8mm	<input type="checkbox"/> 12mm <input checked="" type="checkbox"/> 16mm
P1	Pitch between successive cavity centers	<input type="checkbox"/> 2mm	<input type="checkbox"/> 4mm <input checked="" type="checkbox"/> 8mm
Pin1	Pin1 Quadrant	<input checked="" type="checkbox"/> Q1	<input type="checkbox"/> Q2 <input type="checkbox"/> Q3 <input type="checkbox"/> Q4

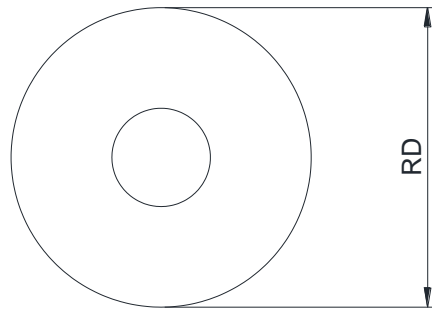
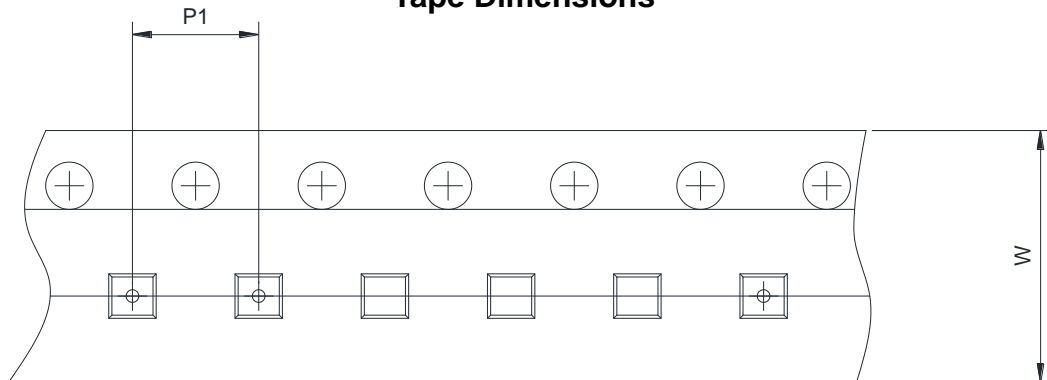
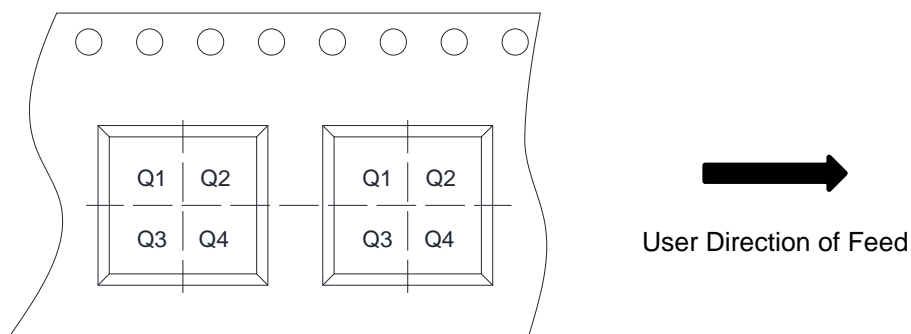
PACKAGE OUTLINE DIMENSIONS
TSSOP-14L

TOP VIEW

SIDE VIEW

SIDE VIEW

Symbol	Dimensions in Millimeters		
	Min.	Typ.	Max.
A	-	-	1.20
A1	0.05	-	0.15
A2	0.80	0.90	1.00
b	0.19	-	0.30
c	0.09	-	0.20
D	4.90	5.00	5.10
E	4.30	4.40	4.50
E1	6.25	6.40	6.55
e	0.65 BSC		
L	0.50	0.60	0.70
H	0.25Typ		
θ	1 °	-	7 °

TAPE AND REEL INFORMATION
Reel Dimensions

Tape Dimensions

Quadrant Assignments For PIN1 Orientation In Tape

RD	Reel Dimension	<input type="checkbox"/> 7inch	<input checked="" type="checkbox"/> 13inch
W	Overall width of the carrier tape	<input type="checkbox"/> 8mm	<input checked="" type="checkbox"/> 12mm <input type="checkbox"/> 16mm
P1	Pitch between successive cavity centers	<input type="checkbox"/> 2mm	<input type="checkbox"/> 4mm <input checked="" type="checkbox"/> 8mm
Pin1	Pin1 Quadrant	<input checked="" type="checkbox"/> Q1	<input type="checkbox"/> Q2 <input type="checkbox"/> Q3 <input type="checkbox"/> Q4

X-ON Electronics

Largest Supplier of Electrical and Electronic Components

Click to view similar products for [Operational Amplifiers - Op Amps](#) category:

Click to view products by [Will Semiconductor](#) manufacturer:

Other Similar products are found below :

[OPA2991IDSGR](#) [OPA607IDCKT](#) [007614D](#) [633773R](#) [635798C](#) [635801A](#) [702115D](#) [709228FB](#) [741528D](#) [NCV33072ADR2G](#)
[SC2902DTBR2G](#) [SC2903DR2G](#) [SC2903VDR2G](#) [LM258AYDT](#) [LM358SNG](#) [430227FB](#) [430228DB](#) [460932C](#) [AZV831KTR-G1](#) [409256CB](#)
[430232AB](#) [LM2904DR2GH](#) [LM358YDT](#) [LT1678IS8](#) [042225DB](#) [058184EB](#) [070530X](#) [SC224DR2G](#) [SC239DR2G](#) [SC2902DG](#)
[SCYA5230DR2G](#) [714228XB](#) [714846BB](#) [873836HB](#) [MIC918YC5-TR](#) [TS912BIYDT](#) [NCS2004MUTAG](#) [NCV33202DMR2G](#)
[M38510/13101BPA](#) [NTE925](#) [SC2904DR2G](#) [SC358DR2G](#) [LM358EDR2G](#) [AZV358MTR-G1](#) [AP4310AUMTR-AG1](#) [HA1630D02MMEL-E](#)
[NJM358CG-TE2](#) [HA1630S01LPEL-E](#) [LM324AWPT](#) [HA1630Q06TELL-E](#)